	TECHNICAL SPECIFICATION	No. I-ET-3010.00-5529-812-PAZ-001	REV. F
			SHEET 2 of 20
	TITLE: ANNULUS PRESSURE MONITORING AND RELIEF SYSTEM		NP-1

**INDEX**

<b>1. TERMS, ABBREVIATIONS AND DEFINITIONS.....</b>	<b>3</b>
<b>2. STANDARDS AND APPLICABLE DOCUMENTS .....</b>	<b>4</b>
<b>3. INTRODUCTION .....</b>	<b>4</b>
<b>3.1. GENERAL REQUIREMENTS</b>	
<b>4. AUTOMATIC TYPE.....</b>	<b>6</b>
<b>4.1. AUTOMATIC TYPE DESCRIPTION</b>	
<b>4.2. AUTOMATIC TYPE CONFIGURATION AND DATA LIST OF COMPONENTS</b>	
<b>4.3. COMPONENT BASIC REQUIREMENTS AND SPECIFICATIONS - AUTOMATIC TYPE</b>	
<b>5. NON-AUTOMATIC OR MANUAL TYPE .....</b>	<b>10</b>
<b>5.1. MANUAL TYPE DESCRIPTION</b>	
<b>5.2. MANUAL TYPE CONFIGURATION AND DATA LIST OF COMPONENTS</b>	
<b>5.3. COMPONET BASIC REQUIREMENTS AND SPECIFICATIONS - MANUAL TYPE</b>	
<b>6. CONTINUOUS VENTED TYPE.....</b>	<b>13</b>
<b>6.1. CONTINUOUS VENTED TYPE (WITH HEADER)</b>	
<b>6.2. LOCAL CONTINUOUS VENTED TYPE</b>	
<b>7. SYSTEM SET POINTS.....</b>	<b>19</b>
<b>8. SYSTEM ACCEPTANCE TEST .....</b>	<b>19</b>
<b>9. DOCUMENTATION.....</b>	<b>19</b>

	TECHNICAL SPECIFICATION	No.	I-ET-3010.00-5529-812-PAZ-001	REV.	F
				SHEET	3 of 20
	TITLE: ANNULUS PRESSURE MONITORING AND RELIEF SYSTEM			NP-1	
			SUB/ ES/ DCT		

## 1. TERMS, ABBREVIATIONS AND DEFINITIONS

**Annulus** – Space between two extruded polymer layers, for example, the internal pressure sheath and external sheath that is sealed in the end fitting (NOTE Permeated gas and liquid are generally free to move and mix in the annulus) – As per API SPECIFICATION 17J: 2014 (item 3.1.2).

**CONTRACTOR** – The entity responsible for Engineering, Procurement and Construction of the FPU.

**Digital Transmitter** – Microprocessor based instrument, with digital communication interface.

**End Fitting** – Structural/mechanical device for terminating the different pipe layers in such a way as to transfer the load between the flexible pipe and the connector and seal all internal and external fluid containment layers – As per API SPECIFICATION 17J: 2014 (item 3.1.28).

**Flexible riser** – A flexible pipe connecting a platform/buoy/ship to a flowline, seafloor installation, or another platform where the riser may be freely suspended (free, catenary), restrained to some extent (buoys, chains), totally restrained, or enclosed in a tube (I- or J-tubes) layers – As per API SPECIFICATION 17J: 2014 (item 3.1.38).

**FMRC** – Factory Mutual Research Corporation.

**FPU** – Floating Production Unit.

**HV** – Tag for manual blocking valve.

**Internal Pressure Sheath** – Polymer layer excluding any sacrificial layers that ensures internal-fluid integrity. This layer may consist of a number of sublayers, excluding sacrificial layers – As per API SPECIFICATION 17J: 2014 (item 3.1.42).

**Maximum Measurement Error** – Is the maximum error of the equipment, considering accuracy, linearity, hysteresis, repeatability and offset.

**Outer Sheath** – Polymer layer used to protect the pipe against penetration of seawater and other external environments, corrosion, abrasion, and mechanical damage. This layer may consist of a number of sublayers – As per API SPECIFICATION 17J: 2014 (item 3.1.52).

**PLC** – Programmable Logic Controller.

**PI** – Plant Information (Software used to acquire historical trends from the field instruments).

**PIT** – Pressure Indicator Transmitter. See Transmitter.

**PSV** – Pressure Safety Valve. In this Technical Specification, PSV is a synonym of pressure relief valve.

**Range** – The region within the measured values are (e.g.: Range: from 30mbar to 500mbar).

**Safe area** – Area (place) onboard where it is allowed and considered safe to exhaust the permeated gas from the Annulus (eventually with contaminants as CO<sub>2</sub> and H<sub>2</sub>S) without risks for the health of the personnel, for the integrity of the installations (and of the FPU), for the security of the operations, and for the quality of the environment conditions. The concept is also valid for disposal of the liquid phase formed (condensate) inside the piping.

**Shall** – Denotes requirements which are mandatory and, therefore, which must be fulfilled.

	TECHNICAL SPECIFICATION	No.	I-ET-3010.00-5529-812-PAZ-001	REV.	F
				SHEET	4 of 20
	TITLE: ANNULUS PRESSURE MONITORING AND RELIEF SYSTEM			NP-1	
			SUB/ ES/ DCT		

**SN Curves** – Means the curves of materials - showing stress range vs number of cycles - that are used by the manufacturer to define the fatigue life of dynamic risers submitted to cyclic loads.

**Transmitter** – The sensing element and the electronics that interprets and determines the measure (microprocessor based instrument).

**VENDOR** – A system or equipment Supplier, subcontracted by the CONTRACTOR.

**XV or X-V** – Tag used for solenoid valves.

## **2. STANDARDS AND APPLICABLE DOCUMENTS**

NOTE: Unless otherwise stated, the latest revision of the following documents shall be considered.

[Ref. 1] **API SPECIFICATION 17J** – Specification for Unbonded Flexible Pipe: 2014.

[Ref. 2] **ISO 13628-2** – Unbonded flexible pipe systems for subsea and marine applications: 2006.

[Ref. 3] **I-ET-004** – Safety Philosophy.

[Ref. 4] **IEC 60079** – Electrical apparatus for explosive gas atmospheres.

[Ref. 5] **ISO- 16852 CORR 2** – Flame arresters – Performance requirements, test methods and limits for use TECHNICAL CORRIGENDUM 2 First Edition.

## **3. INTRODUCTION**

This Technical Specification describes the components and establishes the requirements for the implementation, by the CONTRACTOR, of the '*Annulus Pressure Monitoring and Relief System*'.

The requirements are only applied to FPU's that are connected to the top End fittings of the Flexible risers, at emerged positions (above the waterline, out of the splash-zone).

The main purposes of the '*Annulus Pressure Monitoring and Relief System*' are:

- To monitor and control, during Flexible riser operation, the pressure build up in the Annulus (keeping pressure values within the allowable and safe limits). Additionally, to monitor the pressure build up rates and relief intervals;
- To vent and exhaust the relieved Permeated gas into a Safe area onboard.

Pressure build up in the Annulus is mainly caused by gas permeation from the Flexible pipe bore.

Abnormalities may be related to the following Flexible riser failure mechanisms, for example:

- PSV blockage or plug in the Flexible riser gas venting system leading to: Permeated gas build up in the Annulus, rupture/ burst of riser Outer sheath and formation of a corrosive environment into the Annulus;
- Excessive deformation or degradation of the Internal pressure sheath material leading to: cracks in this layer (failure of the End fitting sealing system), leakage of medium into Annulus, rupture of Flexible riser Outer sheath and medium external leakage.

	TECHNICAL SPECIFICATION	No.	I-ET-3010.00-5529-812-PAZ-001	REV.	F
				SHEET	5 of 20
	TITLE: ANNULUS PRESSURE MONITORING AND RELIEF SYSTEM			NP-1	
			SUB/ ES/ DCT		

The basic configurations and the technical requirements presented in this Technical Specification are divided depending on the adopted type of 'Annulus Pressure Monitoring and Relief System' among the following 3 (three) types:

- **Automatic Type** – See **item 4** of this Technical Specification;
- **Non-automatic or Manual Type** – See **item 5** of this Technical Specification;
- **Continuous Vented Type** – See **item 6** of this Technical Specification.

According to [Ref. 1 and Ref. 2], the Flexible riser gas-venting system is required to prevent excessive pressure build-up in Annulus. The maximum allowable pressure values in the riser Annulus depend on riser design premises (including the internal fluid specified parameters and composition data, as partial pressure of H<sub>2</sub>S or CO<sub>2</sub> for example).

### 3.1 General Requirements

**3.1.1-** The type of the 'Annulus Pressure Monitoring and Relief System' to be provided and implemented by the CONTRACTOR shall be in accordance with the type defined in the FPU design basis issued by PETROBRAS.

**3.1.2-** CONTRACTOR shall perform and document detailed engineering of the *Annulus Pressure Monitoring and Relief System*, including Risk assessment reports, Design reports, Technical Specifications of the components of the system (e.g. Piping, Headers, Sensors, Transmitters, Valves and complementary Equipment).

**3.1.3-** CONTRACTOR shall perform and document detailed engineering of the *Annulus Pressure Monitoring and Relief System* based on representative Permeated gas data applicable to the Flexible riser structures to be connected to the FPU. In case the Permeated gas data are informed (by PETROBRAS) as "preliminary data", then CONTRACTOR shall confirm that the proposed system to be implemented is safe and adequate to perform its function based on the definitive and final representative data. In this case, the confirmation shall be documented in the Project executive phase.

**3.1.4-** CONTRACTOR shall determine the exact location of the Safe area onboard to exhaust the gas (for any type of the 'Annulus Pressure Monitoring and Relief System' presented here), based on internationally recognized technical assumptions, premises, methodologies and criteria.

**3.1.5-** CONTRACTOR shall perform a risk assessment according to [Ref. 3: I-ET-004 – Safety Philosophy] and submit (to be approved by PETROBRAS) a Risk Analysis Report to technically justify the determination of the Safe area location to exhaust the gas. The Risk Analysis Report shall be based on representative Permeated gas data (e.g. flow rates applicable to the riser structures to be connected to the FPU) and shall be in accordance with the FPU gas dispersion plan.

**NOTE 1:** In case it is expected - in the Project executive phase - to have the previously informed Permeated gas data revised, then a preliminary Risk Analysis Report (based on the available and preliminary Permeated gas data) may be submitted. In this case, in the Project executive phase, CONTRACTOR shall confirm the location of the Safe area onboard to exhaust the Permeated gas, based on the final Permeated gas data (e.g. flow rates applicable to the Flexible riser structures to be connected to the FPU). See item 3.1.3

	TECHNICAL SPECIFICATION	No.	I-ET-3010.00-5529-812-PAZ-001	REV.	F
				SHEET	6 of 20
	TITLE: ANNULUS PRESSURE MONITORING AND RELIEF SYSTEM			NP-1	
			SUB/ ES/ DCT		

**3.1.6-** The basic configurations presented in this Technical Specification (depending on the adopted type of 'Annulus Pressure Monitoring and Relief System') represents a conception design. CONTRACTOR shall detail the respective conception design and shall propose an executive design for final implementation after its approval by PETROBRAS.

**3.1.7-** The piping dimensions and all other component dimensions proposed throughout this document are the minimum required for the application. CONTRACTOR shall confirm these dimensions (or propose an appropriated one higher or equal than the minimum proposed in this document) based on representative Permeated gas data (e.g. flow rate) applicable to the Flexible riser structures to be connected to the FPU. See item 3.1.3.

**3.1.8-** CONTRACTOR shall be responsible for all component material selection, in order to guarantee compatibility with the process fluids (e.g. corrosion resistant) and external environment in contact. The material for all components in contact with the process fluids shall be AISI 316 stainless steel or better. CONTRACTOR shall confirm the compatibility of the materials based on representative Permeated gas data (e.g. gas composition) applicable to the Flexible riser structures to be connected to the FPU. See item 3.1.3.

**3.1.9-** CONTRACTOR shall provide all technical evidences of the adequacy of the selected material to the field conditions. If the CONTRACTOR wishes to propose other materials to be used in these components, evidences of the proposed material adequacy shall be submitted to PETROBRAS for approval.

**3.1.10-** Representative Permeated gas data (e.g. flow rates, gas compositions) shall be referred in the detailed design documentation to be provided by CONTRACTOR. See item 3.1.3.

**3.1.11-** The 'Annulus Pressure Monitoring and Relief System' shall not be connected to the Flare. It shall be vented to the atmosphere in a Safe area.

**3.1.12-** Although the system will operate in the range of 0 to 5 barg, all components shall be rated to withstand from -3 barg to 10 barg.

**3.1.13-** As a general directive, all valves and equipment (e.g. pumps, PIT) shall be installed in accessible places (for in service inspection and maintenance), without scaffolding. In addition, connections to the Flexible riser top End fitting (and Annulus) shall be easily accessed.

**3.1.14-** CONTRACTOR shall explain any divergences in its proposal regarding this specification, in the form of a list of deviations. The failure in submitting the deviations in a clear and distinguish way shall be considered as an affirmative of acceptance and full understanding of the content of this document.

**3.1.15-** It is the responsibility of the CONTRACTOR to inform in writing to PETROBRAS, in the proposal, the existence of any conflict or divergence among the documents of this project.

**3.1.16-** The total or partial non attendance to this Technical Specification shall be explained by the CONTRACTOR on a list of exceptions.

#### **4. AUTOMATIC TYPE**

##### **4.1 Automatic Type Description**

The Automatic Type integrates, into the FPU Supervisory system, both the automatic data acquisition process (performed automatically by Digital transmitters) and the automatic control

process (performed automatically by a Solenoid valve actuation). The Automatic Type allows the Operator to configure alarms, to record historic series (and historic trends) and to have a tighter control of the Annulus conditions.

The Annulus shall be isolated by a Solenoid valve (X-V) resulting in monitored pressure build up due to the gas permeation. When the pressure reaches a pre-defined limit value, the Solenoid valve (X-V) opens, alleviating the Annulus pressure. Figure 4.1 shows the Annulus pressure behavior over time and the set points.

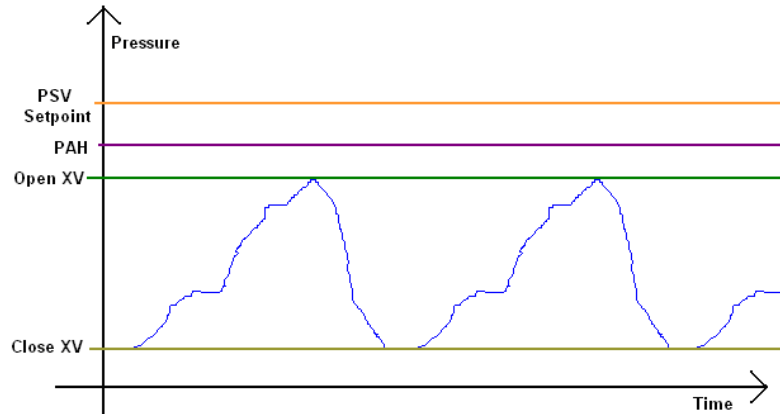

Figure 4.1 – Annulus Pressure behavior over time and set points

#### 4.2 Automatic Type Configuration and Data List of Components

The Automatic Type configuration is shown by Figure 4.2 and it consists of the components listed in Table 4.1. The component numbers mentioned on the Figure 4.2 are referred on Table 4.1.

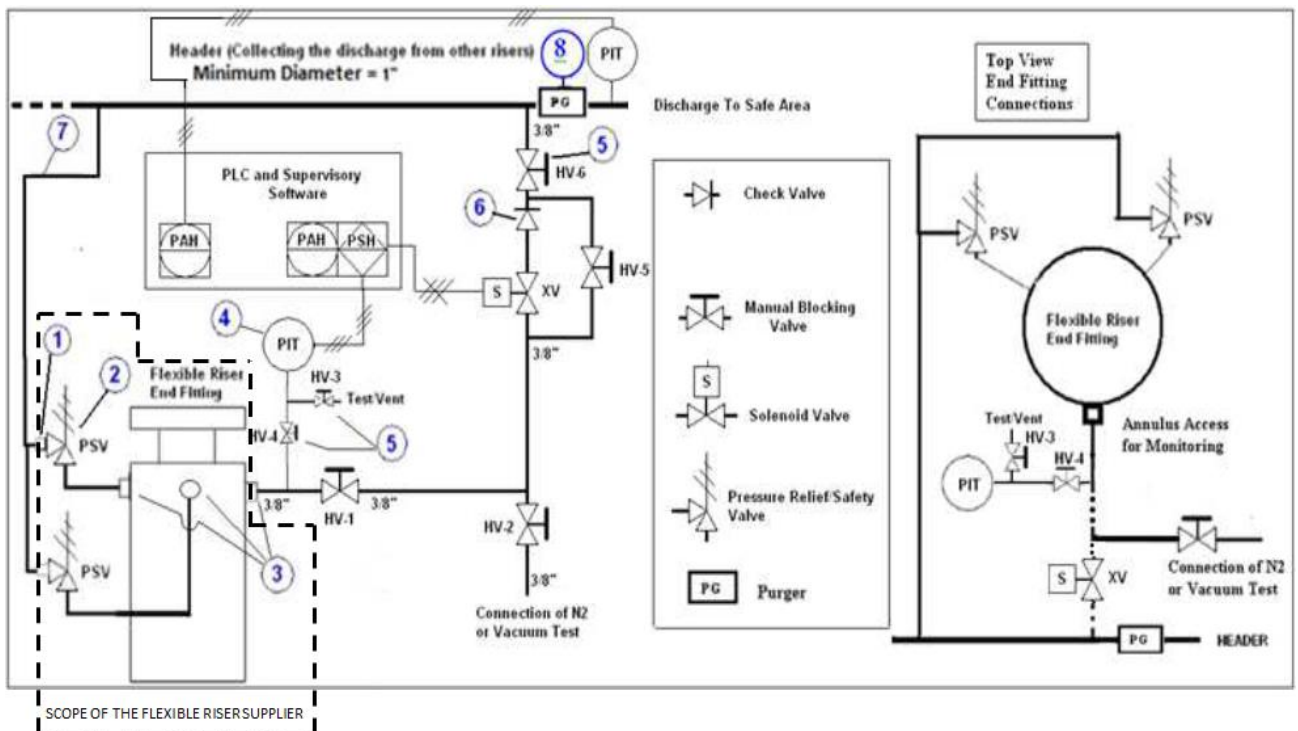



Figure 4.2 – Basic Diagram for the Automatic Type

	TECHNICAL SPECIFICATION	No.	I-ET-3010.00-5529-812-PAZ-001	REV.	F
	TITLE:			SHEET	8 of 20
	ANNULUS PRESSURE MONITORING AND RELIEF SYSTEM			NP-1	
			SUB/ ES/ DCT		

Item	Description of the Component	Specification (and Quantities)	Scope of supply
1	PSV Adapter	As per Flexible riser supplier	Flexible riser supplier
2	PSV	As per Flexible riser supplier (2)	Flexible riser supplier
3	Riser Access Connection	As per Flexible riser supplier (3)	Flexible riser supplier
4	Pressure Indicator Transmitter (PIT)	As per CONTRACTOR	CONTRACTOR
5	Manual Blocking Valve	As per CONTRACTOR	CONTRACTOR
6	Check Valve	As per CONTRACTOR	CONTRACTOR
7	Piping	As per CONTRACTOR	CONTRACTOR
8	Purger	As per CONTRACTOR	CONTRACTOR

**Table 4.1 – Data List of Components – Automatic Type**

### 4.3 Component Basic Requirements and Specifications - Automatic type

**4.3.1-** For the Automatic type, CONTRACTOR shall complete the data list required in Table 4.1 above in order to specify and to determine the quantity of the components to be purchased (or to be provided) in this case.

**4.3.2-** The Solenoid valve (X-V) shall be of 3/8" and be certified to zone 1 IIA T3 (explosion proof type Ex-d), according to [Ref. 4: IEC 60079], with IP 56 or higher. The valve shall be of safe open type.

**4.3.3-** The Annulus gas discharge of each riser shall be collected by 1 (one) header with the minimum of 1" ID, as shown in Figure 4.2.

**4.3.4-** The technical specifications and quantities of the PSV Adapter (**item 1** of Figure 4.2 and Table 4.1) shall be informed and confirmed by the Flexible riser supplier.

**4.3.5-** The technical specifications and quantities of all PSVs (**item 2** of Figure 4.2 and Table 4.1) shall be informed and confirmed by the Flexible riser supplier (according to the specified technical requirements). According to [Ref. 1 and Ref. 2], at least, 2 (two) PSVs shall be used, as represented in Figure 4.2.

**4.3.6-** Each Flexible riser End fitting is normally supplied with 3 (three) connection ports for access to the Annulus (**item 3** of Figure 4.2 and Table 4.1). 1 (one) of these 3 (three) connections shall be used for the circuit with the Solenoid Valve (X-V) and the other 2 (two) ones shall be used for the circuit with the PSVs, as represented in Figure 4.2.

**NOTE 1:** The purpose of the set of 2 (two) PSVs (one as a backup of the other) is to act as a second safety layer in case of any failure of the 'Annulus Pressure Monitoring and Relief System'. In this case, 1 (one) of these 2 (two) PSVs will alleviate the Annulus pressure, discharging the Permeated gas to a Safe area through an alternative circuit, as per Figure 4.2.

**NOTE 2:** As stated before, connections to the Flexible riser top End fitting (and Annulus) shall be easily accessed (for in service maintenance), without scaffolding.

**4.3.7-** The Annulus pressure is sensed by a Pressure Transmitter (**item 4** of Figure 4.2 and Table 4.1) that shall be linked to a PLC. The PLC shall execute the required logic to actuate the Solenoid valve (X-V).

**4.3.8-** The Pressure Transmitter (**item 4** of Figure 4.2 and Table 4.1) shall be placed as close as possible to the Flexible riser top End fitting, in a location accessible to the workers, and shall



	TECHNICAL SPECIFICATION	No.	I-ET-3010.00-5529-812-PAZ-001	REV.	F
				SHEET	9 of 20
	TITLE: ANNULUS PRESSURE MONITORING AND RELIEF SYSTEM			NP-1	
			SUB/ ES/ DCT		

have a local LCD display. This display will be used to monitor the pressure on site during the N<sub>2</sub> test (Nitrogen test).

**4.3.9-** In addition, a Pressure Transmitter shall be installed near the outlet of the discharge header, to detect any clogging or plugging at this location (as represented by Figure 4.2).

**4.3.10-** Pressure values (and X-V status and X-V actuation indications) shall be available in the FPU supervisory system and PI system. Alarms that represent abnormalities (such as abnormal pressure build up in the Annulus, malfunction of the X-V or any clogging or plugging at the outlet of the discharge header) shall be set in the software of the FPU supervisory system.

**4.3.11-** The Pressure Transmitters shall be certified for zone 1 IIA T3, according to [Ref. 4: IEC 60079], with IP 56 or higher.

**4.3.12-** The Pressure Transmitters shall be provided calibrated, with its calibration reports.

**4.3.13-** The Pressure Transmitters shall attend the following minimum requirements:

- Range: 0 to 5 barg;
- Maximum Measurement Error:  $\pm 0.1$  bar.

**4.3.14-** The Manual Blocking Valves (**item 5** of Figure 4.2 and Table 4.1) shall be of 3/8" and shall be placed in a local with easy access to the workers. The valves shall be gas-tight.

**4.3.15-** 6 (six) Manual Blocking Valves (e.g. ball valve) are required for isolation of the circuit, as shown in Figure 4.2:

- **Normal Operation:** HV-1, HV-4 and HV-6 shall be opened and HV-2, HV-3 and HV-5 shall be closed;
- **Maintenance of the circuit:** HV-1 and HV-6 shall be closed;
- **Outer Sheath Nitrogen or Vacuum Test:** HV-1 and HV-2 shall be opened and HV-3, HV-4, HV-5 and HV-6 shall be closed;
- **By-Pass:** HV-5 shall be opened. This by-pass shall be used in case the X-V get stuck in the closed position.

**4.3.16-** The check valve (**item 6** of Figure 4.2 and Table 4.1) shall be of 3/8" and have a maximum set pressure of 0.2 bar.

**4.3.17-** The local piping (**item 7** of Figure 4.2 and Table 4.1) that connects the Annulus of each riser to the header shall be with the minimum of 3/8" ID, as shown in Figure 4.2.

**4.3.18-** The local piping (**item 7** of Figure 4.2 and Table 4.1) shall be delivered by CONTRACTOR with a female stainless steel, JIC 37°, 9/16"- 18UNF End fittings for 3/8" to be connected to the Flexible riser top End fitting. The piping shall be delivered with plugs that are required to prevent entry of dirt and moisture in the piping. The piping shall be delivered clean (flushed) and dry. The connection of the riser Annulus to the venting system will be carried out by PETROBRAS.

**4.3.19-** The Tee joint intended for either N<sub>2</sub> (Nitrogen test) or Vacuum test shall have a plugged 3/8" NPT thread termination and shall have an easy access for the workers.

**4.3.20-** A Purger (**item 8** of Figure 4.2 and Table 4.1) shall be installed in the header, at the lowest position of the piping, for the disposal of the liquid phase formed (condensate). Since the

fluid may contain contaminants such as H<sub>2</sub>S and CO<sub>2</sub>, it shall be discarded to an appropriate and Safe area.

**4.3.21-** The Purger (**item 8** of Figure 4.2 and Table 4.1) is a mandatory component in the Automatic Type (as per figure 4.2). The piping adopted shall be designed in order to minimize the possibility of liquid accumulation and backpressure. As a general directive it is suggested to use a Purger with electronic actuation, certified to Zone 1 IIA T3 (explosion proof type Ex-d), according to [Ref. 4: IEC 60079], with IP 56 or higher. Alternative solutions for the purge may also be accepted if proven that they do not lead to pressure build-up and shall be submitted to Petrobras for approval.

**5. NON-AUTOMATIC OR MANUAL TYPE**

**5.1 Manual Type Description**

The Manual Type does not integrate, into the FPU Supervisory system, neither the data acquisition process (not performed automatically) nor the control one (performed manually).

**5.2 Manual Type Configuration and Data List of Components**

The Manual Type configuration is shown by Figure 5.1 and it consists of the components listed in Table 5.1. The component numbers mentioned on the Figure 5.1 are referred on Table 5.1.

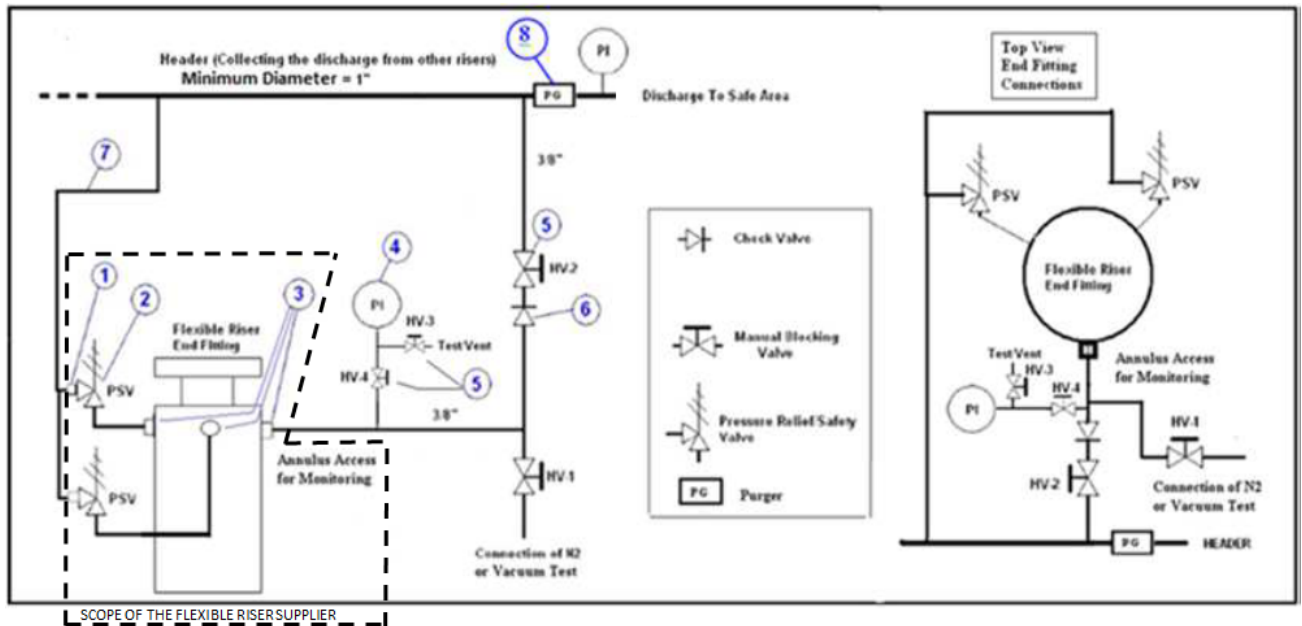

**Figure 5.1 – Basic Diagram for the Manual Annulus Monitoring and Relief System**

	TECHNICAL SPECIFICATION	No.	I-ET-3010.00-5529-812-PAZ-001	REV.	F
				SHEET	11 of 20
	TITLE: ANNULUS PRESSURE MONITORING AND RELIEF SYSTEM			NP-1	
			SUB/ ES/ DCT		

Item	Description of the Component	Specification (and Quantities)	Scope of supply
1	PSV Adapter	As per Flexible riser supplier	Flexible riser supplier
2	PSV	As per Flexible riser supplier (2)	Flexible riser supplier
3	Riser Access Connection	As per Flexible riser supplier (3)	Flexible riser supplier
4	Pressure Indicator Transmitter (PIT)	As per CONTRACTOR	CONTRACTOR
5	Manual Blocking Valve	As per CONTRACTOR	CONTRACTOR
6	Check Valve	As per CONTRACTOR	CONTRACTOR
7	Piping	As per CONTRACTOR	CONTRACTOR
8	Purger	As per CONTRACTOR	CONTRACTOR

**Table 5.1 – Data List of Components – Manual Type**

### 5.3 Component Basic Requirements and Specifications - Manual type

**5.3.1-** For the Manual type, CONTRACTOR shall complete the data list required in Table 5.1 above in order to specify and determine the quantity of the components to be purchased (or to be provided) in this case.

**5.3.2-** The Annulus gas discharge of each riser shall be collected by 1 (one) header with the minimum of 1" ID, as shown in Figure 5.1.

**5.3.3-** The technical specifications and quantities of the PSV Adapter (**item 1** of Figure 5.1 and Table 5.1) shall be informed and confirmed by the Flexible riser supplier.

**5.3.4-** The technical specifications and quantities of all PSVs (**item 2** of Figure 5.1 and Table 5.1) shall be informed and confirmed by the Flexible riser supplier (according to the specified technical requirements). According to [Ref. 1 and Ref. 2], at least, 2 (two) PSVs shall be used, as represented in Figure 5.1.

**5.3.5-** Each Flexible riser End fitting is normally supplied with 3 (three) connection ports for access to the Annulus (**item 3** of Figure 5.1 and Table 5.1). 1 (one) of these 3 (three) connections shall be used for the discharge circuit with the (HV-2) and the other 2 (two) ones shall be used for the circuit with the PSVs, as represented in Figure 5.1.

**NOTE 1:** The purpose of the set of 2 (two) PSVs (one as a backup of the other) is to act as a second safety layer in case of any failure of the 'Annulus Pressure Monitoring and Relief System'. In this case, 1 (one) of these 2 (two) PSVs will alleviate the Annulus pressure, discharging the Permeated gas to a Safe area through an alternative circuit, as per Figure 5.1.

**NOTE 2:** As stated before, connections to the Flexible riser top End fitting (and Annulus) shall be easily accessed (for in service maintenance), without scaffolding.

**5.3.6-** The Annulus pressure is sensed by a Pressure Transmitter (item 4 of Figure 5.1 and Table 5.1). The Pressure Transmitter shall be placed as close as possible to the Flexible riser top End fitting, in a location accessible to the workers, and shall have a local LCD display. This display will be used to monitor the pressure on site during the N<sub>2</sub> test (Nitrogen test).

**5.3.7-** In addition, a Pressure Transmitter shall be installed near the outlet of the discharge header, to detect any clogging or plugging at this location (as represented by Figure 5.1).

	TECHNICAL SPECIFICATION	No.	I-ET-3010.00-5529-812-PAZ-001	REV.	F
				SHEET	12 of 20
	TITLE:			ANNULUS PRESSURE MONITORING AND RELIEF SYSTEM	
			NP-1		
			SUB/ ES/ DCT		

**5.3.8-** The Pressure Transmitters shall be certified for zone 1 IIA T3, according to [Ref. 4: IEC 60079], with IP 56 or higher.

**5.3.9-** The Pressure Transmitters shall be provided calibrated, with its calibration reports.

**5.3.10-** The Pressure Transmitters shall attend the following minimum requirements:

- Range: 0 to 5 barg;
- Maximum Measurement Error:  $\pm 0.1$  bar.

**5.3.11-** The Manual Blocking Valves (**item 5** of Figure 5.1 and Table 5.1) shall be of 3/8" and shall be placed in a local with easy access to the workers. The valves shall be gas-tight.

**5.3.12-** 4 (Four) Manual Blocking Valves (e.g. ball valve) are required for isolation of the circuit, as shown in Figure 5.1:

- **Normal Operation:** HV-4 shall be opened, HV-1, HV-2 and HV-3 shall be closed;
- **Maintenance of the circuit:** HV-2 and HV-3 shall be closed (it is required to relieve the pressure before by HV-1);
- **Outer Sheath Nitrogen or Vacuum Test:** HV-1 shall be opened and HV-2, HV-3 and HV-4 shall be closed.
- **Manual Pressure Relief:** HV-2 shall be opened.

**5.3.13-** The check valve (**item 6** of Figure 5.1 and Table 5.1) shall be of 3/8" and have a maximum set pressure of 0.2 bar.

**5.3.14-** The local piping (**item 7** of Figure 5.1 and Table 5.1) that connects the Annulus of each riser to the header shall be with the minimum of 3/8" ID, as shown in Figure 5.1.

**5.3.15-** The local piping (**item 7** of Figure 5.1 and Table 5.1) shall be delivered by CONTRACTOR with a female stainless steel, JIC 37°, 9/16"- 18UNF End fittings for 3/8" to be connected to the Flexible riser top End fitting. The piping shall be delivered with plugs that are required to prevent entry of dirt and moisture in the piping. The piping shall be delivered clean (flushed) and dry. The connection of the riser Annulus to the venting system will be carried out by PETROBRAS.

**5.3.16-** The Tee joint intended for either N<sub>2</sub> (Nitrogen test) or Vacuum test shall have a plugged 3/8" NPT thread termination and shall have an easy access for the workers.

**5.3.17-** A Purger (**item 8** of Figure 5.1 and Table 5.1) shall be installed in the header, at the lowest position of the piping, for the disposal of the liquid phase formed (condensate). Since the fluid may contain contaminants such as H<sub>2</sub>S and CO<sub>2</sub>, it shall be discarded to an appropriate and Safe area.

**5.3.18-** The Purger (**item 8** of Figure 5.1 and Table 5.1) is a mandatory component in the Manual Type (as per figure 5.1). The piping adopted shall be designed in order to minimize the possibility of liquid accumulation and backpressure. As a general directive it is suggested to use a Purger with electronic actuation, certified to Zone 1 IIA T3 (explosion proof type Ex-d), according to [Ref. 4: IEC 60079], with IP 56 or higher. Alternative solutions for the purge may also be accepted if proven that they do not lead to pressure build-up and shall be submitted to Petrobras for approval.

	TECHNICAL SPECIFICATION	No. I-ET-3010.00-5529-812-PAZ-001	REV. F
			SHEET 13 of 20
	TITLE: ANNULUS PRESSURE MONITORING AND RELIEF SYSTEM		NP-1

## 6. CONTINUOUS VENTED TYPE

The Continuous Vented Type is characterized by the pressure monitoring in the Annulus that is continuously kept in contact with the external environment at an atmosphere pressure.

As per cited in item 3 (INTRODUCTION), if the dimensioning and material selection of the Flexible riser structure are based on riser Annulus continuously vented to the atmosphere, then the Continuous Vented Type shall be used instead of any other type (Automatic or Manual one).

The main purpose of adopting the Continuous Vented Type is to keep the *Annulus* pressure as low as possible. Normally, this type is adopted for Sour service riser applications (or risers that flow acid gas).

The Continuous Vented Type configurations and requirements are classified according to the following 2 different options:

### 6.1- Continuous Vented Type (with Header);

### 6.2- Local Continuous Vented Type.

#### 6.1.1 Continuous Vented Type (with Header) – Configuration and Data List of Components

This option is applied on FPU with Flexible riser top End fittings located inside a confined place (e.g. Turret of the FPU).

The configuration of the **Continuous Vented Type (with Header)** is shown by Figure 6.1 and it consists of the components listed in Table 6.1. The component numbers mentioned on the Figure 6.1 are referred on Table 6.1.

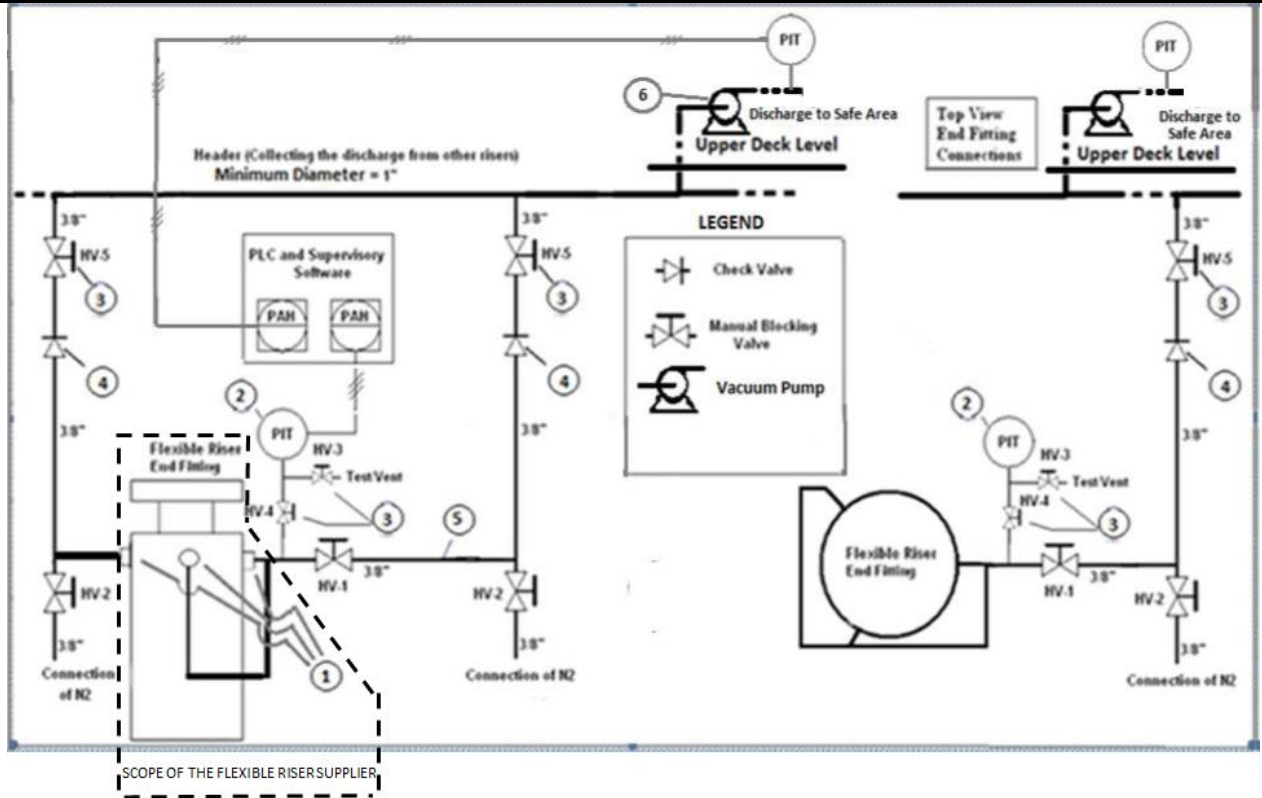

Figure 6.1 – Basic Diagram for the Continuous Vented Type (with Header)

Item	Description of the Component	Specification (and Quantities)	Scope of supply
1	Riser Access Connection	As per Flexible riser supplier (3)	Flexible riser supplier
2	Pressure Indicator Transmitter (PIT)	As per CONTRACTOR	CONTRACTOR
3	Manual Blocking Valve	As per CONTRACTOR	CONTRACTOR
4	Check Valve	As per CONTRACTOR	CONTRACTOR
5	Piping	As per CONTRACTOR	CONTRACTOR
6	Vacuum Pump	As per CONTRACTOR	CONTRACTOR

Table 6.1 – Data List of Components – Continuous Vented Type (with Header)

**6.1.2 Component Basic Requirements and Specifications - Continuous Vented Type (with Header)**

**6.1.2.1-** For the Continuous Vented Type (with Header), CONTRACTOR shall complete the data list required in Table 6.1 above in order to specify and determine the quantity of the components to be purchased (or to be provided) in this case.

**6.1.2.2-** For this type, the Annulus shall be continuously exhausted using a pumping system that generates a negative pressure so to assure that all fluids gathered from each riser and conveyed to the header to be vented, as represented in Figure 6.1.

**NOTE:** The **Continuous Vented Type** shall not allow the build-up of backpressure in the system. Therefore, the devices annexed to the system (e.g. check valves) shall be specified and configured to minimize the pressure build-up.

	TECHNICAL SPECIFICATION	No.	I-ET-3010.00-5529-812-PAZ-001	REV.	F
				SHEET	15 of 20
	TITLE: ANNULUS PRESSURE MONITORING AND RELIEF SYSTEM			NP-1	
			SUB/ ES/ DCT		

**6.1.2.3-** The Annulus gas discharge of each riser shall be collected by 1 (one) header with the minimum of 1" ID, as shown in Figure 6.1. The header will be connected a vertical piping that will exhaust all gathered fluids from the header to a Safe area.

**6.1.2.4-** Each Flexible riser End fitting is normally supplied with 3 (three) connection ports for access to the Annulus (**item 1** of Figure 6.1 and Table 6.1). As stated before, connections to the Flexible riser top End fitting (and Annulus) shall be easily accessed (for in service maintenance), without scaffolding.

**6.1.2.5-** The Annulus pressure is sensed by a Pressure Transmitter (**item 2** of Figure 6.1 and Table 6.1) that shall be linked to a PLC.

**6.1.2.6-** The Pressure Transmitter (**item 2** of Figure 6.1 and Table 6.1) shall be placed as close as possible to the Flexible riser top End fitting, in a location accessible to the workers, and shall have a local LCD display. This display will be used to monitor the pressure on site during the N<sub>2</sub> test (Nitrogen test).

**6.1.2.7-** In addition, a Pressure Transmitter shall be installed near the outlet of the discharge header, to detect any clogging or plugging at this location (as represented by Figure 6.1).

**6.1.2.8-** Pressure values shall be available in the FPU supervisory system and PI system. Alarms that represent abnormalities (such as abnormal pressure build up in the Annulus or any clogging or plugging at the outlet of the discharge header) shall be set in the software of the FPU supervisory system.

**6.1.2.9-** The Pressure Transmitters shall be certified for zone 1 IIA T3, according to [Ref. 4: IEC 60079], with IP 56 or higher.

**6.1.2.10-** The Pressure Transmitters shall be provided calibrated, with its calibration reports.

**6.1.2.11-** The Pressure Transmitters shall attend the following minimum requirements:

- Range: 0 to 5 barg;
- Maximum Measurement Error: ± 0.1 bar.

**6.1.2.12-** The Manual Blocking Valves (**item 3** of Figure 6.1 and Table 6.1) shall be of 3/8" and shall be placed in a local with easy access to the workers. The valves shall be gas-tight.

**6.1.2.13-** The HV-2 physical location (position) shall be determined by the CONTRACTOR based on Risk Analysis evaluation considering the following scenario: In case of pressure alarm, the valve HV-2 shall be opened in order to reduce the pressure on the PIT to protect the Flexible riser Outer sheath. If the pressure is not reduced the valve HV-1 shall be closed and the pipes shall be cleaned.

**6.1.2.14-** 5 (five) manual blocking valves (e.g.: ball valve) are required for isolation of the circuit:

- **Normal Operation:** HV-1, HV-4 and HV-5 shall be opened and HV-2 and HV-3 shall be closed;
- **Maintenance of the circuit:** HV-1 and HV-5 shall be closed;
- **Outer Sheath Nitrogen or Vacuum Test:** HV-1 and HV-2 shall be opened and HV-4 and HV-5 shall be closed.

**6.1.2.15-** The following blocking valves shall be lock open: HV-1, HV-4 and HV-5.

	TECHNICAL SPECIFICATION	No.	I-ET-3010.00-5529-812-PAZ-001	REV.	F
				SHEET	16 of 20
	TITLE: ANNULUS PRESSURE MONITORING AND RELIEF SYSTEM			NP-1	
			SUB/ ES/ DCT		

**6.1.2.16-** The check valve (**item 4** of Figure 6.1 and Table 6.1) shall be of 3/8" and have a maximum set pressure of 0.2 bar.

**6.1.2.17-** The local piping (**item 5** of Figure 6.1 and Table 6.1) that connects the Annulus of each riser to the header shall be with the minimum of 3/8" ID, as shown in Figure 6.1.

**NOTE 1:** Piping will individually connect each Flexible riser End fitting (and its Annulus) to a header that will receive all fluids gathered from the risers.

**6.1.2.18-** The local piping (**item 5** of Figure 6.1 and Table 6.1) shall be delivered by CONTRACTOR with a female stainless steel, JIC 37°, 9/16"- 18UNF End fittings for 3/8" to be connected to the Flexible riser top End fitting. The piping shall be delivered with plugs that are required to prevent entry of dirt and moisture in the piping. The piping shall be delivered clean (flushed) and dry. The connection of the riser Annulus to the venting system will be carried out by PETROBRAS.

**6.1.2.19-** The Tee joint intended for either N<sub>2</sub> (Nitrogen test) or Vacuum test shall have a plugged 3/8" NPT thread termination and shall have an easy access for the workers.

**6.1.2.20-** The local pumping system (**item 6** of Figure 6.1 and Table 6.1) shall fulfill the following requirements:

- a) This local system shall prevent the ingress of air from the external environment at the level of 5 ppb of O<sub>2</sub> maximum, which is compatible with the criteria for oxygen allowed in the Flexible riser Annulus and for SN Curves used in riser design for wet and flooded Annulus conditions.
- b) At the upper deck level, the pumping system will provide an appropriate negative pressure to the header and lower piping so to assure the exhausting of all gathered fluids from the Annulus of all the Flexible risers.
- c) The pumping system shall consist of at least two pumps (1 spare). Whenever the pump in continuous operation stops, the spare pumps shall automatically start operation. The system shall have a manifold with check valves and flanged connections that allows the easy retrieval of the damaged pump for maintenance without the stoppage of the exhausting of fluids from the respective Annulus of all the Flexible risers.
- d) The pumps shall have high MTTF and MTBF (above 5 years).
- e) The pump must operate continuously with a negative pressure of 0.2 bar at the flexible riser end fitting considering the lost of charge of all the system (piping, valves, etc).

**NOTE 1:** As stated before, all valves and equipment (e.g. pumps) shall be installed in accessible places (for in service inspection and maintenance), without scaffolding.

### 6.2.1 Local Continuous Vented Type – Configuration and Data List of Components

This option is applied on FPU with Flexible riser top End fittings located in vented places (e.g. riser balcony of a Spread Mooring FPU). In this case, the Annulus shall be continuously vented to the atmosphere.

The configuration of **the Local Continuous Vented Type** is shown by Figure 6.2 and it consists of the components listed in Table 6.2. The component numbers mentioned on the Figure 6.2 are referred on Table 6.2.



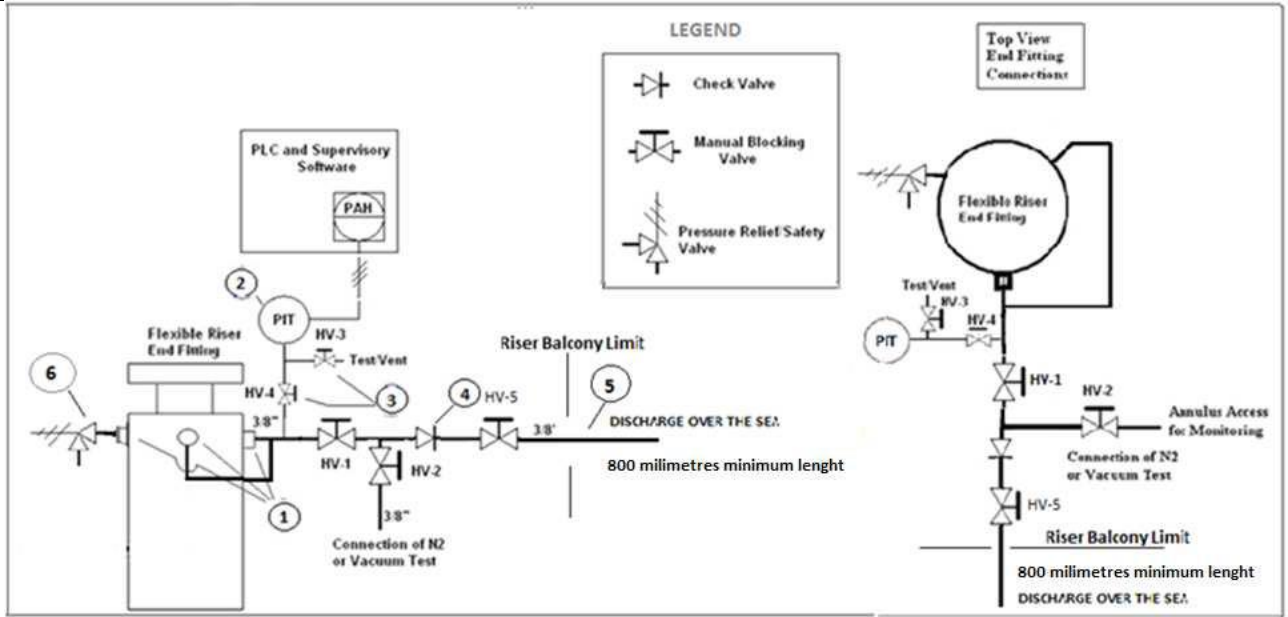

**Figure 6.2 – Basic Diagram for the Local Continuous Vented Type**

Item	Description of the Component	Specification (and Quantities)	Scope of supply
1	Riser Access Connection	As per Flexible riser supplier (3)	Flexible riser supplier
2	Pressure Indicator Transmitter (PIT)	As per CONTRACTOR	CONTRACTOR
3	Manual Blocking Valve	As per CONTRACTOR	CONTRACTOR
4	Check Valve	As per CONTRACTOR	CONTRACTOR
5	Piping	As per CONTRACTOR	CONTRACTOR
6	PSV	As per Flexible riser supplier (1)	Flexible riser supplier

**Table 6.2 – Data List of Components – Local Continuous Vented Type**

### 6.2.2 Component Basic Requirements and Specifications – Local Continuous Vented Type

**6.2.2.1-** For the **Local Continuous Vented Type**, CONTRACTOR shall complete the data list required in Table 6.2 above in order to specify and determine the quantity of the components to be purchased (or to be provided) in this case.

**6.2.2.2-** For this type, the Annulus shall be continuously vented, as represented in Figure 6.2. The discharge shall be over sea and at least 800 millimeters descendent from the riser balcony.

**6.2.2.3-** CONTRACTOR shall be responsible to follow all the applicable safety rules to confirm the location of the Safe area (point of discharge of the Annulus gas of each riser).

**6.2.2.4-** This type (option) shall prevent the ingress of air from the external environment at the level of 5 ppb of O<sub>2</sub> maximum, which is compatible with the criteria for oxygen allowed in the Flexible riser Annulus and for SN Curves used in riser design for wet and flooded Annulus conditions.

**6.2.2.5-** Each Flexible riser End fitting is normally supplied with 3 (three) connection ports for access to the Annulus (**item 1** of Figure 6.2 and Table 6.2). As stated before, connections to the Flexible riser top End fitting (and Annulus) shall be easily accessed (for in service maintenance), without scaffolding.

	TECHNICAL SPECIFICATION	No.	I-ET-3010.00-5529-812-PAZ-001	REV.	F
				SHEET	18 of 20
	TITLE: ANNULUS PRESSURE MONITORING AND RELIEF SYSTEM			NP-1	
			SUB/ ES/ DCT		

**6.2.2.6-** The Annulus pressure is sensed by a Pressure Transmitter (**item 2** of Figure 6.2 and Table 6.2) that shall be linked to a PLC.

**6.2.2.7-** The Pressure Transmitter (**item 2** of Figure 6.2 and Table 6.2) shall be placed as close as possible to the Flexible riser top End fitting, in a location accessible to the workers, and shall have a local LCD display. This display will be used to monitor the pressure on site during the N<sub>2</sub> test (Nitrogen test).

**6.2.2.8-** Pressure values shall be available in the FPU supervisory system and PI system. Alarms that represent abnormalities (such as abnormal pressure build up in the Annulus) shall be set in the software of the FPU supervisory system.

**6.2.2.9-** The Pressure Transmitters shall be certified for zone 1 IIA T3, according to [Ref. 4: IEC 60079], with IP 56 or higher.

**6.2.2.10-** The Pressure Transmitters shall be provided calibrated, with its calibration reports.

**6.2.2.11-** The Pressure Transmitters shall attend the following minimum requirements:

- Range: 0 to 5 barg;
- Maximum Measurement Error: ± 0.1 bar.

**6.2.2.12-** The Manual Blocking Valves (**item 3** of Figure 6.2 and Table 6.2) shall be of 3/8" and shall be placed in a local with easy access to the workers. The valves shall be gas-tight.

**6.2.2.13-** In case of pressure alarm, the valve HV-2 shall be opened in order to reduce the pressure on the PIT to protect the Flexible riser Outer sheath. If the pressure is not reduced the valve HV-1 shall be closed and the pipes shall be cleaned.

**6.2.2.14-** 5 (five) manual blocking valves (e.g.: ball valve) are required for isolation of the circuit:

- **Normal Operation:** HV-1, HV-4 and HV-5 shall be opened and HV-2 and HV-3 shall be closed;
- **Maintenance of the circuit:** HV-1 shall be closed;
- **Outer sheath Nitrogen or Vacuum Test:** HV-1 and HV-2 shall be opened and HV-3, HV-4 and HV-5 shall be closed.

**6.2.2.15-** The check valve (**item 4** of Figure 6.2 and Table 6.2) shall be of 3/8" and have a maximum set pressure of 0.2 bar.

**6.2.2.16-** The local piping (**item 5** of Figure 6.2 and Table 6.2) that connects the Annulus of each riser to the header shall be with the minimum of 3/8" ID, as shown in Figure 6.2.

**6.2.2.17-** The local piping (**item 5** of Figure 6.2 and Table 6.2) shall be delivered by CONTRACTOR with a female stainless steel, JIC 37°, 9/16"- 18UNF End fittings for 3/8" to be connected to the Flexible riser top End fitting. The piping shall be delivered with plugs that are required to prevent entry of dirt and moisture in the piping. The piping shall be delivered clean (flushed) and dry. The connection of the riser Annulus to the venting system will be carried out by PETROBRAS.

**6.2.2.18-** The Tee joint intended for either N<sub>2</sub> (Nitrogen test) or Vacuum test shall have a plugged 3/8" NPT thread termination and shall have an easy access for the workers.

	TECHNICAL SPECIFICATION	No. I-ET-3010.00-5529-812-PAZ-001	REV. F
			SHEET 19 of 20
	TITLE: ANNULUS PRESSURE MONITORING AND RELIEF SYSTEM		NP-1

**6.2.2.19-** 1 (one) PSV (**item 6** of Figure 6.2 and Table 6.2) shall be kept on the top End fitting as shown in Figure 6.2 (The PSV shall be supplied by the Flexible riser manufacturer).

**6.2.2.20-** All components (valves, equipment and connections) shall be installed in accessible places (with easy access for in service maintenance), without scaffolding.

## **7. SYSTEM SET POINTS**

**7.1-** The following system set points shall be used:

- Open X-V (Automatic Type): 1 barg;
- Close X-V (Automatic Type): 0.5 barg;
- PAH: 1,5 barg (Manual or Automatic System);
- PAH (header): 1.0 barg (Continuous Vented System with Header);
- PAH (for both Local Continuous Vented System and With Header): 1,0 barg.

**7.2-** These set points shall be software configurable by PETROBRAS.

## **8. SYSTEM ACCEPTANCE TEST**

**8.1-** In order to demonstrate the system integrity and its functionality, acceptance tests shall be conducted by the CONTRACTOR/VENDOR, witnessed by PETROBRAS. The acceptance test shall verify the (i) integrity of all piping (as per design code selected by the CONTRACTOR) and, also, the functionality of each component (e.g. check valve, purger, pump, and relief system).

**8.2-** The CONTRACTOR/VENDOR shall elaborate a test procedure, to be approved by PETROBRAS. PETROBRAS shall be informed with at least one month of antecedence the local and date of the test.

## **9. DOCUMENTATION**

**9.1-** At least, the following documents shall be submitted by CONTRACTOR:

- Datasheet of all components;
- System Component List, with part numbers;
- Welding Procedure Specifications (WPS) and welding procedure qualification records (WPQR);
- Welders qualification records;
- Inspection plan for piping welding including DNE;
- Acceptance Test Procedure;
- Pressure transmitters calibration reports;
- Mechanical drawings;
- List of Exceptions or Deviations to this Technical Specification;
- PLC codes (logics);

	TECHNICAL SPECIFICATION	No.	I-ET-3010.00-5529-812-PAZ-001	REV.	F
				SHEET	20 of 20
	TITLE: ANNULUS PRESSURE MONITORING AND RELIEF SYSTEM			NP-1	
			SUB/ ES/ DCT		

- Table relating the TAG of each pressure transmitter to its serial number and its riser;
- Risk Analysis Report (see item 3.1.5).