 PETROBRAS	TECHNICAL SPECIFICATION		N°: I-ET-3010.00-5500-854-P4X-001
	CLIENT: SRGE		SHEET: 1 of 24
	JOB:		
	AREA:		
	TITLE: MACHINERY MONITORING SYSTEM (MMS)		ESUP
			INTERNAL
MICROSOFT WORD / V. 365 / I-ET-3010.00-5500-854-P4X-001_G.DOC			

INDEX OF REVISION

REV.	DESCRIPTION AND/OR REVISED SHEETS
0	ORIGINAL
A	REVISED WHERE INDICATED
B	REVISED WHERE INDICATED ACCORDING TO CONSISTENCY ANALYSIS
C	REVISED WHERE INDICATED
D	REVISED WHERE INDICATED
E	REVISED WHERE INDICATED
F	REVISED WHERE INDICATED
G	REVISED WHERE INDICATED

	REV. 0	REV.C	REV. D	REV. E	REV. F	REV. G
DATE	SEPT/27/18	JUN/21/21	SEP/10/21	AUG/25/22	MAR/15/24	APR/15/24
EXECUTION	CAMILA	U44D	U5D6	U5D6	U44D	CLWK
CHECK	IGORARANTES	U49R	U49R	U5EM	U49R	U361
APPROVAL	RENNÓ	U4JB	TZN5	U49R	CDC1	CDC1

THE INFORMATION CONTAINED IN THIS DOCUMENT IS PETROBRAS' PROPERTY AND MAY NOT BE USED FOR PURPOSES OTHER THAN THOSE SPECIFICALLY INDICATED HEREIN. THIS FORM IS PART OF PETROBRAS' NI-381-REV.M.

	TECHNICAL SPECIFICATION	I-ET-3010.00-5500-854-P4X-001	REV.: G
			SHEET: 2 of 24
	TITLE: MACHINERY MONITORING SYSTEM (MMS)		ESUP

SUMMARY

1	INTRODUCTION.....	3
2	REFERENCE DOCUMENTS, CODES AND STANDARDS	4
3	ENVIRONMENTAL AND OPERATION CONDITIONS	7
4	SYSTEM DESCRIPTION AND REQUIREMENTS	8
5	DOCUMENTATION	19
6	ACCEPTANCE TESTS.....	20
7	ACCEPTANCE TESTS.....	20
	ANNEX A – EQUIPMENT TO BE MONITORED BY THE MMS	21
	ANNEX B – MMS ARCHITECTURE IN CASE OF MULTIPLE SUPPLIERS	23

 PETROBRAS	TECHNICAL SPECIFICATION	I-ET-3010.00-5500-854-P4X-001	REV.: G
			SHEET: 3 of 24
	TITLE: MACHINERY MONITORING SYSTEM (MMS)		ESUP

1 INTRODUCTION

1.1 Object

- 1.1.1 This specification describes the minimum requirements for the supply of equipment, software and integration of the MACHINERY MONITORING SYSTEM (MMS), to be installed at the UNIT, covering all equipment, material, software, licenses, interconnections, documentation, system configuration, tests and installation.

1.2 Definitions

- 1.2.1 Refer to I-ET-3010.00-1200-940-P4X-002 – GENERAL TECHNICAL TERMS for the definition of words emphasized in upper case along this document.

1.3 Abbreviations, Acronyms and Initialisms

AC/DC	Alternating Current/Direct Current
CPU	Central Processing Unit
CSS	Control and Safety System
CSV	Comma Separated Values file format
DAM	Dynamic Acquisition Module
DAS	Data Acquisition Server
DMZ	Demilitarized Zone
EMI	Electromagnetic Interference
FAT	Factory Acceptance Test
FFT	Fast Fourier Transform
FGRU	Flare Gas Recovery Unit
GDU	Gas Dehydration Unit
GG	Gas Generator
HCS	Hull Control System
HSD	Hull Shutdown System
IGV	Inlet Guide Vane
I/O	Input / Output
KVM	Keyboard, Video, Mouse
LAN	Local Area Network
LCD	Liquid Crystal Display
LED	Light-Emitting Diode
MMS	Machinery Monitoring System
MPS	Machinery Protection System
MTE	Ministry of Labor and Employment (<i>Portuguese</i> : Ministério do Trabalho)
OPC UA	Open Platform Communications Unified Architecture
PAP	Protection and Acquisition Panel
PAS	Package Automation System
PCS	Process Control System
PLC	Programmable Logic Controller
PSD	Process Shutdown System
PT	Power Turbine
RFI	Radio Frequency Interference
RIC	Internal Corporate Network
RTDS	Real Time Data Server
SAT	Site Acceptance Test
SIT	Site Integration Test

	TECHNICAL SPECIFICATION	I-ET-3010.00-5500-854-P4X-001	REV.: G
			SHEET: 4 of 24
	TITLE: MACHINERY MONITORING SYSTEM (MMS)		ESUP

SNTP	Simple Network Time Protocol
SOS	Supervision and Operation System
SRU	Sulfate Removal Unit
SSD	Solid State Drive
TAP	Performance Acceptance Test
TEG	Triethylene Glycol
TCP/IP	Transmission Control Protocol/Internet Protocol
UCP	Unit Control Panel (Package Control Panel)
USB	Universal Serial Bus
VAC	AC voltage
VCI	Volatile Corrosion Inhibitor
VDC	DC voltage

2 REFERENCE DOCUMENTS, CODES AND STANDARDS

2.1 External references

2.1.1 International Codes, Recommended Practices and Standards

API - AMERICAN PETROLEUM INSTITUTE

API STD 670 MACHINERY PROTECTION SYSTEMS - FIFTH EDITION

ASTM - AMERICAN SOCIETY FOR TESTING AND MATERIALS

ASTM G21 STANDARD PRACTICE FOR DETERMINING RESISTANCE OF SYNTHETIC POLYMERIC MATERIALS TO FUNGI

IEC - INTERNATIONAL ELECTROTECHNICAL COMMISSION

- IEC 60068 ENVIRONMENTAL TESTING – ALL PARTS
- IEC 60092-350 ELECTRICAL INSTALLATIONS IN SHIPS – PART 350 - GENERAL CONSTRUCTION AND TEST METHODS OF POWER, CONTROL AND INSTRUMENTATION CABLES FOR SHIPBOARD AND OFFSHORE APPLICATIONS
- IEC 60092-376 ELECTRICAL INSTALLATIONS IN SHIPS – PART 376 - CABLES FOR CONTROL AND INSTRUMENTATION CIRCUITS 150/250 V (300 V)
- IEC 60092-504 ELECTRICAL INSTALLATIONS IN SHIPS - PART 504: AUTOMATION, CONTROL AND INSTRUMENTATION
- IEC 60297-3 MECHANICAL STRUCTURES FOR ELECTRONIC EQUIPMENT - DIMENSIONS OF MECHANICAL STRUCTURES OF THE 482,6 MM (19 IN) SERIES – PART 3 – 100 THROUGH 109
- IEC 60533 ELECTRICAL AND ELECTRONIC INSTALLATIONS IN SHIPS - ELECTROMAGNETIC COMPATIBILITY (EMC) – SHIPS WITH A METALLIC HULL
- IEC 61000 ELECTROMAGNETIC COMPATIBILITY (EMC) - ALL PARTS
- IEC 61086 COATINGS FOR LOADED PRINTED WIRE BOARDS (CONFORMAL COATINGS) – ALL PARTS

	TECHNICAL SPECIFICATION	I-ET-3010.00-5500-854-P4X-001	REV.: G
			SHEET: 5 of 24
	TITLE: MACHINERY MONITORING SYSTEM (MMS)		ESUP

IEC 62381 AUTOMATION SYSTEMS IN THE PROCESS INDUSTRY - FACTORY ACCEPTANCE TEST (FAT), SITE ACCEPTANCE TEST (SAT) AND SITE INTEGRATION TEST (SIT)

ISO - INTERNATIONAL ORGANIZATION FOR STANDARDIZATION

- ISO 13372 CONDITION MONITORING AND DIAGNOSTICS OF MACHINES — VOCABULARY
- ISO 13373-1 CONDITION MONITORING AND DIAGNOSTICS OF MACHINES - VIBRATION CONDITION MONITORING - PART 1 - GENERAL PROCEDURES
- ISO 17359 CONDITION MONITORING AND DIAGNOSTICS OF MACHINES - GENERAL GUIDELINES

2.1.2 Brazilian Codes and Standards

INMETRO - INSTITUTO NACIONAL DE METROLOGIA, NORMALIZAÇÃO E QUALIDADE INDUSTRIAL

PORTARIA Nº 115 (21/MARÇO/2022) REQUISITOS DE AVALIAÇÃO DA CONFORMIDADE PARA EQUIPAMENTOS ELÉTRICOS PARA ATMOSFERAS EXPLOSIVAS - CONSOLIDADO

2.1.3 Classification Society

- 2.1.3.1 Project's Detail Design Phase documents shall be submitted to Classification Society's approval. The design and installation shall take into account their requirements and comments.
- 2.1.3.2 The design, installation and operation shall strictly follow the Classification Society's requirements, along with the specific requirements identified in this document, including also all referenced documents' requirements.

2.2 Internal References

2.2.1 Typical Documents

I-ET-3010.00-1200-800-P4X-013	GENERAL CRITERIA FOR INSTRUMENTATION PROJECTS
I-ET-3010.00-1200-800-P4X-002	AUTOMATION, CONTROL AND INSTRUMENTATION ON PACKAGE UNITS
I-ET-3010.00-5520-800-P4X-004	AUTOMATION NETWORK REQUIREMENTS
I-ET-3010.00-5520-888-P4X-001	AUTOMATION PANELS
I-ET-3010.00-5140-700-P4X-003	ELECTRICAL REQUIREMENTS FOR PACKAGES FOR OFFSHORE UNITS
I-ET-3010.00-1200-800-P4X-013	GENERAL CRITERIA FOR INSTRUMENTATION PROJECTS

	TECHNICAL SPECIFICATION	I-ET-3010.00-5500-854-P4X-001	REV.: G
			SHEET: 6 of 24
	TITLE: MACHINERY MONITORING SYSTEM (MMS)		ESUP
		INTERNAL	

I-ET-3010.00-5147-332-P4X-001	TECHNICAL SPECIFICATION - GAS TURBINE DRIVER FOR GAS TURBOGENERATOR SET
I-ET-3010.00-1225-323-P4X-001	TECHNICAL SPECIFICATION FOR VAPOR RECOVERY UNIT
I-ET-3010.00-1200-321-P4X-001	TECHNICAL SPECIFICATION FOR CENTRIFUGAL COMPRESSOR DRIVEN BY ELECTRIC MOTOR

2.2.2 Specific Project Documents

This section specifies documents that are referenced along the text and are part of a specific project. For that reason, the document's identification number is not yet defined and may vary according to project. The document's title may also vary slightly from one project to another. Project's DOCUMENT LIST shall be consulted in order to verify the correct document number and title.

INSTRUMENTATION ADDITIONAL TECHNICAL REQUIREMENTS

FIELD INSTRUMENTATION

AUTOMATION INTERFACE OF PACKAGED UNITS

AUTOMATION AND CONTROL ARCHITECTURE

AUTOMATION NETWORK DESCRIPTION

NETWORK INTERCONNECTION DIAGRAM

2.2.3 PETROBRAS Reference Documents

DR-ENGP-M-I-1.3-R.5 SAFETY ENGINEERING

2.3 Brazilian regulation (MTE section) and INMETRO regulation are enforced by Brazilian law and therefore superpose all codes and regulations listed in item 2.2.

	TECHNICAL SPECIFICATION	I-ET-3010.00-5500-854-P4X-001	REV.: G
			SHEET: 7 of 24
	TITLE: MACHINERY MONITORING SYSTEM (MMS)		ESUP

3 ENVIRONMENTAL AND OPERATION CONDITIONS

- 3.1 For environmental and operating conditions and/or any requirements regarding this topic, refer to project's technical specification entitled "INSTRUMENTATION ADDITIONAL TECHNICAL REQUIREMENTS".
- 3.2 The available power supplied by the UNIT to be used by the MMS is defined in I-ET-3010.00-5140-700-P4X-003 – ELECTRICAL REQUIREMENTS FOR PACKAGES FOR OFFSHORE UNITS – ANNEX I. It is part of the MMS scope to convert and distribute the different power supplies inside MMS panels, including, where necessary, AC/DC or DC/DC stabilized power supply units for cabinet's internal distribution of 24 VDC. For further details, see I-ET-3010.00-5520-888-P4X-001 – AUTOMATION PANELS.
- 3.3 Zone, temperature, and ingress protection classification shall be according to I-ET-3010.00-1200-800-P4X-013 – GENERAL CRITERIA FOR INSTRUMENTATION PROJECTS, I-ET-3010.00-5520-888-P4X-001 – AUTOMATION PANELS and project's technical specification entitled "FIELD INSTRUMENTATION".
- 3.4 All MMS Server Panels, Workstations and PAP shall be installed indoors. The location shall follow the specific project documentation.

	TECHNICAL SPECIFICATION	I-ET-3010.00-5500-854-P4X-001	REV.: G
			SHEET: 8 of 24
	TITLE: MACHINERY MONITORING SYSTEM (MMS)		ESUP

4 SYSTEM DESCRIPTION AND REQUIREMENTS

4.1 General

4.1.1 The Machinery Monitoring System (MMS) shall collect all measurement data, including vibrations, temperature and operating/running hours, from Critical Rotating Machines, provide information for diagnostic on the condition of the assets, and fault identification.

4.1.2 The MMS shall have the following functions:

- Data logging and event/variable recording and storing;
- Listing of all incoming alarms chronologically;
- Historical and predictive trending (of all variables);
- Real-time measurements in order to allow diagnostics of fault detection and analysis;
- Display of equipment schematic layout;
- Measurements covering the widest possible range of machine faults;
- Data available for use over local area network.

4.1.3 MMS shall be capable of predicting or anticipating deterioration in rotating equipment with sufficient lead-time to permit corrective action prior to failure providing resources for predictive maintenance program.

4.1.4 MMS shall provide performance, condition and behavior monitoring of various parts of rotating equipment by acquiring and analyzing signals and data. This information shall be continuously monitored and logged to achieve the following:

- Increase machine availability and reliability;
- Reduce or eliminate unscheduled downtime;
- Reduce operation and maintenance costs;
- Provide basis for defining inspection and maintenance activity schedules;
- Provide failure analysis in the event of an incident.

4.1.5 MMS shall be capable of storing sets of vibration reference data from a chosen period of time and use these sets for comparison with data sets from other periods.

4.1.6 MMS shall be capable of compensating vibration runout signals by means of subtraction of stored reference data.

4.1.7 It shall be possible to export sensor data and analysis results from MMS to a CSV file format to be retrievable through network or using a USB 3.0 stick.

4.1.8 MMS system shall provide tools for detecting the equipment defects and degradation, so that preemptive action may be taken to reduce system outages due to equipment failure.

4.1.9 The MMS shall consist of:

- One or more MMS Server Panels;
- One or more MMS Workstations;
- Two MMS Protection and Acquisition Panels (PAP), one for the hull systems and one for the topsides systems, and their internal Machinery Protection Systems (MPS) and Data Acquisition Monitors (DAM);
- MPS of PACKAGE UNITS (supplied by others).

4.1.10 All measurement points shall have their electrical and mechanical characteristics configured (e.g. direction of rotation, bearing type, bearing clearance etc.).

	TECHNICAL SPECIFICATION	I-ET-3010.00-5500-854-P4X-001	REV.: G
			SHEET: 9 of 24
	TITLE: MACHINERY MONITORING SYSTEM (MMS)		ESUP
<p>4.1.11 All cables interconnecting MMS components or interconnecting equipment transducers to MMS components shall be adequately dimensioned taking into account the signal to be transported through the cable, cable's entity parameters and MANUFACTURER's recommendations. Supplier shall calculate the maximum cable length to avoid the signal attenuation for signals with high frequency. Entity parameters shall be calculated to be lower than the limit imposed for intrinsic safe circuits. For more information see I-ET-3010.00-1200-800-P4X-013 - GENERAL CRITERIA FOR INSTRUMENTATION PROJECTS.</p> <p>4.1.12 Equipment monitored by the MMS shall be P0, P2, P2S or P2C type PACKAGE UNITS. Some equipment that do not consist of PACKAGE UNITS may also be monitored, in which case the information regarding P0 PACKAGE UNITS shall be applied. See ANNEX A – EQUIPMENT TO BE MONITORED BY THE MMS.</p> <p>4.1.13 Cabinet mechanical characteristic for MMS panels shall be according to I-ET-3010.00-1200-800-P4X-002 - AUTOMATION, CONTROL AND INSTRUMENTATION ON PACKAGE UNITS and I-ET-3010.00-5520-888-P4X-001 – AUTOMATION PANELS.</p> <p>4.1.14 All MMS equipment having electronic components or circuits shall be immune to electromagnetic and radiofrequency (EMI-RFI) interference according to IEC 60533.</p> <p>4.1.15 All MMS equipment shall operate without loss of reliability, availability or performance within a voltage variation of 10% above or below rated voltage.</p> <p>4.1.16 All materials and equipment with mechanical protection shall have test certificates issued by an authorized and duly identified laboratory.</p> <p>4.1.17 Power supply and internal distribution shall be according to item 3.2.</p> <p>4.1.18 If any of the supplied MMS components (including hardware, firmware, software etc.) becomes obsolete during warranty period, supplier shall replace the component with another component that meets all necessary requirements, and any necessary interface adaptation, without any additional cost.</p> <p>4.2 MMS Server Panel</p> <p>4.2.1 The MMS Server Panel(s) shall be installed indoors and shall house the Data Acquisition Servers (DAS), rack mounted monitor and keyboard, managed industrial network switches and any other hardware required for the system. Panels shall be according to I-ET-3010.00-5520-888-P4X-001 – AUTOMATION PANELS.</p> <p>4.2.2 The MMS Server Panel(s) shall house two networks: MMS LAN PCKG which is the MMS LAN that is connected to PACKAGE UNITS LAN; and MMS LAN SOS which is the MMS LAN that is connected to SOS LAN. MMS LAN PCKG and MMS LAN SOS shall not be directly interconnected, in order not to interconnect the UNITS' networks.</p> <p>4.2.3 The MMS Server Panel shall exchange data with the other system components through the following LANs:</p> <ul style="list-style-type: none"> • MMS Workstation through the MMS LAN PCKG; • Machinery Protection Systems (MPS) of P2, P2S or P2C type PACKAGE UNITS through the MMS LAN PCKG; • MPS and DAM in MMS Protection and Acquisition Panel (PAP) of P0 type PACKAGE UNITS through the MMS LAN PCKG; • CSS-PCS / CSS-HCS RTDS through the MMS LAN SOS (and SOS LAN); 			

	TECHNICAL SPECIFICATION	I-ET-3010.00-5500-854-P4X-001	REV.: G
			SHEET: 10 of 24
	TITLE: MACHINERY MONITORING SYSTEM (MMS)		ESUP

- TOPSIDES/HULL PACKAGE UNITS RTDS through MMS LAN PCKG (and PACKAGE UNITS LAN);
- MMS client (which shall be a virtual machine installed in Telecom discipline's Automation DMZ Cluster) for offshore remote access to the MMS servers through the PACKAGE UNITS LAN (which is connected to the TELECOM FIREWALL);
- MMS HISTORICAL SERVER in order to:
 - Collect and store data from all applicable MMS monitored equipment through the PACKAGE UNITS LAN or SOS SUPERVISORY LAN;
 - Collect and store data from MMS's analysis software;
 - Make all stored data and monitored variables available to the PI through the PACKAGE UNITS LAN (an OPC-UA driver compatible with Osisoft's PI shall be supplied and installed).

For more information, see FIGURE 2 – MMS ARCHITECTURE and FIGURE 3 – ONSHORE ACCESS TO THE MMS SERVER.

4.2.4 MMS Data Acquisition Servers shall be capable of interfacing multiple machine protection equipment (MPS and DAM) and multiple PAP. Data acquisition network (MMS LAN) shall take into account the worst-case situation of a simultaneous plant shutdown and guarantee no loss on data integrity. Supplier of the MMS Data Acquisition Servers shall describe in their proposed design how this requirement is addressed.

4.2.5 MMS Data Acquisition Server shall allow archiving the data over a period of at least five years using redundant SSD (solid-state drives) as the long-term media storage devices. Retrieving / analyzing stored data, and the execution of backups, shall be possible without interrupting the current data acquisition.

4.2.6 The MMS asset condition monitoring software shall be responsible for managing data acquisition and storage from critical rotating machines and carry out monitoring and event diagnostics. This software shall communicate with:

- MMS Workstation, as specified in item 4.3;
- Machinery Protection System (MPS) of P2, P2S or P2C type PACKAGE UNITS (supplied by others) as specified in item 4.5;
- MPS and DAM in MMS Protection and Acquisition Panels (PAP) of P0 type PACKAGE UNITS as specified in item 4.4;
- At least 5 (five) simultaneous remote clients (only the licenses to be provided by supplier of the MMS Server Panel);
- TOPSIDES/HULL PACKAGE UNITS RTDS;
- UNIT's HISTORICAL SERVER;
- CSS-PCS RTDS and CSS-HCS RTDS.

4.2.7 MMS switches shall have enough ports available to establish direct communication with MMS Servers, Protection and Acquisition Panels (PAP), MMS Workstation and every MPS of P2, P2S or P2C type PACKAGE UNITS. MMS Server Panel supplier shall be responsible for the adequate sizing of its system, including switches, servers and software licenses, evaluating the monitored projects of PACKAGE UNITS during detailing design phase, noting that a PACKAGE UNIT may have more than one MPS. MMS Servers and MMS Workstation shall have enough network cards for all required connections.

4.2.8 MMS shall support full data monitoring as well as transient and dynamic data analysis plots and trending. The data acquisition while a machine is starting or stopping shall be done at a higher rate to allow significant insight into the rotor and structural dynamics. Time stamping of data, alarms and events shall have a resolution of one millisecond.

	TECHNICAL SPECIFICATION	I-ET-3010.00-5500-854-P4X-001	REV.: G
			SHEET: 11 of 24
	TITLE: MACHINERY MONITORING SYSTEM (MMS)		ESUP

4.2.9 MMS Servers shall acquire the process variables listed on Table 1 via OPC UA from the CSS-PCS RTDS and CSS-HCS RTDS for P0 PACKAGE UNITS and from the TOPSIDES/HULL PACKAGE UNITS RTDS for P2, P2S or P2C PACKAGE UNITS.

Table 1 - Process variables that shall be made available via OPC UA for each monitored equipment.

PUMPS	GAS COMPRESSORS	GAS TURBINES	STEAM TURBINES	ELECTRIC MOTORS AND GENERATORS
<ul style="list-style-type: none"> • SUCTION PRESSURE • DISCHARGE PRESSURE • LUBRICATION OIL PRESSURE • LUBRICATION OIL TEMPERATURE • PUMP INDIVIDUAL FLOW 	<ul style="list-style-type: none"> • LUBE OIL RETURN TEMPERATURE FOR EACH BEARING • SUCTION PRESSURE FOR EACH STAGE • SUCTION TEMPERATURE FOR EACH STAGE • DISCHARGE PRESSURE FOR EACH STAGE • DISCHARGE TEMPERATURE FOR EACH STAGE • ORIFICE PLATE FLOW DIFFERENTIAL PRESSURE FOR EACH STAGE • ANTI-SURGE VALVE OPENING FOR EACH STAGE • PRESSURE FOR EACH SEAL • FLOW RATE FOR EACH SEAL 	<ul style="list-style-type: none"> • INLET AIR PRESSURE DROP • EXHAUST DUCT PRESSURE DROP • INLET AIR TEMPERATURE • AIR COMPRESSOR DISCHARGE PRESSURE • AIR COMPRESSOR DISCHARGE TEMPERATURE • FUEL GAS FLOW ORIFICE PLATE DIFFERENTIAL PRESSURE • FUEL GAS PRESSURE • GAS GENERATOR SPEED 	<ul style="list-style-type: none"> • INLET STEAM PRESSURE • STEAM GENERATOR SPEED • INLET STEAM TEMPERATURE 	<ul style="list-style-type: none"> • APPARENT ELECTRIC POWER • ACTIVE ELECTRIC POWER • REACTIVE ELECTRIC POWER • ELECTRIC CURRENT • WINDING TEMPERATURE

4.2.10 The MMS Server Panel shall collect data from two types of PACKAGE UNITS, as described in the Technical Specification I-ET-3010.00-1200-800-P4X-002-AUTOMATION, CONTROL AND INSTRUMENTATION ON PACKAGE UNITS:

- P0 Type PACKAGE UNITS have no dedicated Unit Control Panel (UCP) and control and safety functions, when required, are performed by UNIT's Control and Safety System (CSS). The vibration and temperature monitoring for those types of equipment shall be integrated in the PAP as specified in item 4.4.
- P2, P2S or P2C Type PACKAGE UNITS have their own Machinery Protection System, installed in the PAS Unit Control Panel, as described in item 4.5.

4.2.11 Process variables from PLCs of PACKAGE UNITS and data related to winding temperature of electrical motors and generators (see Table 1), as well as other electrical data shall be retrieved by the MMS Servers from the TOPSIDES/HULL PACKAGE UNITS RTDS through the PACKAGE UNITS LAN by means of Gigabit Ethernet TCP/IP connection (OPC UA). For further detail, see the project's AUTOMATION AND CONTROL ARCHITECTURE drawing.

4.2.12 All variables acquired by MMS shall be available to SOS via Gigabit Ethernet TCP/IP connection (OPC UA) through the SOS LAN.

4.2.13 MMS DAS Panel Constructive Characteristics

 PETROBRAS	TECHNICAL SPECIFICATION	I-ET-3010.00-5500-854-P4X-001	REV.: G
			SHEET: 12 of 24
	TITLE: MACHINERY MONITORING SYSTEM (MMS)		ESUP

4.2.13.1 Server cabinet shall be:

- Appropriate to house computer CPUs (servers), Ethernet switches, retractable monitor with keyboard and mouse, circuit-breakers, network accessories and other electrical components;
- Composed of 1 (one) 19-inch standardized rack (according to IEC 60297-3-100 through 109);
- Composed of 2 (two) sub-sections for better panel organization: one sub-section shall house the Ethernet switches and the other sub-section shall house the computers.

4.2.13.2 Minimum characteristics of server cabinet:

- Vertically subdivided into 1.75 inches (u), totalizing 42u, with labeled “u” positions;
- Dimensions: Height 2,000 mm, Length 800 mm (19 inches internally), Width 800 mm;
- Rapid rail;
- Perforated door;
- Locking doors and side panels;
- Support approximately 900 kg capacity;
- Forced air ventilation;
- Split rear doors;
- Leveling feet;
- Open bottom.

4.2.13.3 Panels that house DAS shall be supplied with built-in rack console (1u), composed of retractable monitor, keyboard, mouse and an 1u console switch (or KVM) in order to allow its configuration and maintenance. The computer CPUs and the above mentioned video monitor, keyboard and mouse shall be connected to the internal console switch.

4.2.13.4 The retractable video monitor shall be at least 15” and shall be mounted on a 19” standard rack. The monitor shall be LED-lit LCD with a minimum resolution of 1280x1024.

4.2.13.5 The internal keyboard shall be USB 104-key, ABNT-2 (preferable) or ANSI.

4.2.13.6 The retractable monitor, keyboard and mouse shall be ergonomically placed in order to allow their use by a person in standing position (typically with keyboard 1.3 m above floor).

4.2.13.7 Cabinets shall have internal shock absorbers to protect the internal equipment from balance movements and vibration.

4.2.13.8 All hardware shall be of the most recent model at purchase time.

4.2.14 DAS General Characteristics

4.2.14.1 DATABASE architecture for the MMS shall be centralized.

4.2.14.2 The Server shall be supplied as an industrial computer for use in offshore environment. A 3-year on-site warranty shall be supplied. Use of refurbished, used or economy-line equipment is forbidden.

4.2.14.3 The Server shall have at least 2 (two) USB 3.0 interfaces, and at least 04 (four)

	TECHNICAL SPECIFICATION	I-ET-3010.00-5500-854-P4X-001	REV.: G
			SHEET: 13 of 24
	TITLE: MACHINERY MONITORING SYSTEM (MMS)		ESUP

Gigabit Ethernet network interface ports.

- 4.2.14.4 The Server shall be powered by essential external source defined in I-ET-3010.00-5140-700-P4X-003 – ELECTRICAL REQUIREMENTS FOR PACKAGES FOR OFFSHORE UNITS – ANNEX I.
- 4.2.14.5 Processor type, SSD type/space and memory shall be according to the use of the necessary software in its maximum performance configuration. Supplier of the MMS Server Panel shall be responsible for the adequate memory sizing. SSDs shall be sized adequately to store system data (such as log files). The memory sizing shall take into account the requirements of MMS. SSDs shall be redundant, capable of recovering from failure of 1 drive.
- 4.2.14.6 MMS DAS shall be synchronized with SNTP through the PACKAGE UNITS LAN. For more information, see project's NETWORK INTERCONNECTION DIAGRAM.

4.2.15 DAS Minimum Software Requirements

- 4.2.15.1 Operating System: Microsoft ® Windows Server or its equivalent at most recent certified version at purchase time.
- 4.2.15.2 Microsoft ® Office or its equivalent at most recent certified version at purchase time.
- 4.2.15.3 Network security mechanisms (firewall, antivirus, etc.) for server.
- 4.2.15.4 USB security software.
- 4.2.15.5 The MMS supervisory software shall be native OPC UA Client and OPC UA Server.
- 4.2.15.6 All software shall be furnished in their most recent versions at purchase time, accompanied by their corresponding licensing, installation media(s) and manuals, as well as with one year (after TAP) of technical support and maintenance.

4.3 MMS Workstation

4.3.1 The MMS Workstation shall be provided with required software to perform, at least, analysis of the following parameters:

- Mechanical: All dynamic waveform signals (with possibility to make at least the following analysis: FFT, full spectrum, Bode plot, polar plot, cascade plot, waterfall diagram, shaft average center line, orbit, X-Y plot and experience-based vibration analysis) and auxiliary system signals (lube, seal, etc.);
- Aerothermodynamic (gas turbine): at least the following real-time performance maps (in SI units) including actual operating point: PT speed, GG speed, ambient temperature, specific fuel consumption and heat rate versus shaft power; Air flow, axial compressor outlet pressure and temperature, HP turbine outlet pressure and temperature, PT exhaust pressure and temperature, specific fuel consumption, heat rate, combustion chamber temperature and PT speed versus GG speed; Exhaust pressure and temperature versus PT speed; Axial compressor outlet pressure and temperature, HP turbine outlet pressure and temperature, PT exhaust pressure and temperature, GG and PT speeds, IGV positions and control signals, fuel consumption (corrected to 20°C and 1 atm) versus time;

	TECHNICAL SPECIFICATION	I-ET-3010.00-5500-854-P4X-001	REV.: G
			SHEET: 14 of 24
	TITLE: MACHINERY MONITORING SYSTEM (MMS)		ESUP
<ul style="list-style-type: none"> • Turbogenerators: PACKAGER shall furnish performance maps (in SI units) and an algorithm for evaluating turbogenerator performance and total remaining life considering fuel consumption and number of starts. 			
4.3.2 Workstation Minimum Hardware Requirements:			
<p>4.3.2.1 The Workstation shall be supplied as an industrial rack mounted (for standard 19" rack) microcomputer for use in offshore environmental conditions with 1 (one) 21" LED-lit LCD video monitor, ABNT2 Keyboard and Mouse (both wired) and Gigabit Ethernet network interface card. Processor type, SSD (Solid State Drive) type/space and memory shall be according to the use of the necessary software in its maximum performance configuration. A 3-year on-site warranty shall be supplied. Use of refurbished, used or economy-line equipment is forbidden.</p>			
<p>4.3.2.2 The Workstation shall have at least 02 (two) USB 3.0 interfaces and at least 02 (two) Gigabit Ethernet network interface ports.</p>			
<p>4.3.2.3 Standard 19" rack mounted KVM extenders (transmitter/receiver) shall be supplied, since monitor, keyboard and mouse shall be installed in a different environment from the microcomputer CPU.</p>			
<p>4.3.2.4 The Workstation shall be powered by essential external source defined in I-ET-3010.00-5140-700-P4X-003 – ELECTRICAL REQUIREMENTS FOR PACKAGES FOR OFFSHORE UNITS – ANNEX I.</p>			
<p>4.3.2.5 Supplier of the MMS Workstation shall be responsible for the adequate memory sizing. SSDs shall be sized adequately to store system data. The memory sizing shall take into account the requirements of MMS.</p>			
<p>4.3.2.6 All hardware shall be of the most recent model at purchase time.</p>			
4.3.3 Workstation Minimum Software Requirements:			
<p>4.3.3.1 Operating System: Microsoft ® Windows Professional or its equivalent at the last certified version at purchase time.</p>			
<p>4.3.3.2 Microsoft ® Office or its equivalent at the last certified version at purchase time.</p>			
<p>4.3.3.3 Network security mechanisms (firewall, antivirus, etc.) for the workstation.</p>			
<p>4.3.3.4 USB security software.</p>			
4.4 MMS Protection and Acquisition Panel (PAP)			
<p>4.4.1 MMS Protection and Acquisition Panel (PAP) shall house any hardware needed for protection (MPS) and / or data acquisition (DAM) of vibration and bearing temperature of equipment that are not being supplied with Machinery Protection Systems or Data Acquisition Module (PO equipment or equipment that are not PACKAGE UNITS, but shall be monitored by MMS).</p>			
<p>4.4.2 There shall be one PAP for the topsides equipment (TOPSIDES PAP) and one PAP for the hull systems equipment (HULL PAP).</p>			

4.4.3 P0 type PACKAGE UNITS and equipment that are not PACKAGE UNITS but shall be monitored by the MMS shall be integrated in MMS by having their MPS and/or DAM placed in the respective PAP, unless the MANUFACTURER indicates that there are no vibration sensors (see item 4.4.5). Refer to ANNEX A – EQUIPMENT TO BE MONITORED BY THE MMS.

4.4.4 P0 type PACKAGE UNITS shall be provided with sensors as defined in the technical specification of the equipment listed in ANNEX A – EQUIPMENT TO BE MONITORED BY THE MMS.

4.4.4.1 Sensors type, position and quantities indicated in the above mentioned technical specifications are the minimum requirements and shall be confirmed by equipment MANUFACTURER during project's detailing design phase.

4.4.4.2 Supplier of the PAP shall evaluate the projects of all equipment listed in ANNEX A – EQUIPMENT TO BE MONITORED BY THE MMS, being responsible for properly dimensioning MMS to monitor all the available points, and provide shutdown signals for equipment with vibration trip indicated. License shall cover all available points.

4.4.4.3 Paired channels (XY) from the two transducers mounted at each bearing for radial shaft vibration monitoring of a P0 equipment shall be allocated at the same MPS I/O card.

4.4.4.4 The sensors of the equipment for which the MANUFACTURER indicates the need of vibration trip shall be forwarded to a Machine Protection System (MPS) at PAP, which will monitor the variables and be responsible for sending the shutdown signal to the CSS-PSD/CSS-HSD. MMS shall monitor this MPS in the same way as the MPS of P2, P2S or P2C PACKAGE UNITS as described in item 4.5.

4.4.4.5 MPS located in the TOPSIDES PAP shall send the trip signal to the closest CSS-PSD local remote I/O panel and MPS located in the HULL PAP shall send the trip signal to the closest CSS-HSD local remote I/O panel.

4.4.4.6 Interposing relay shall be installed in the PAP (see FIGURE 1). The signals sent from the MPS in the PAP to CSS-PSD/CSS-HSD shall be voltage free dry contacts (1 A @ 24 VDC). The contacts on PAP are closed when in normal operation and open under abnormal process conditions or upon sending a trip signal.

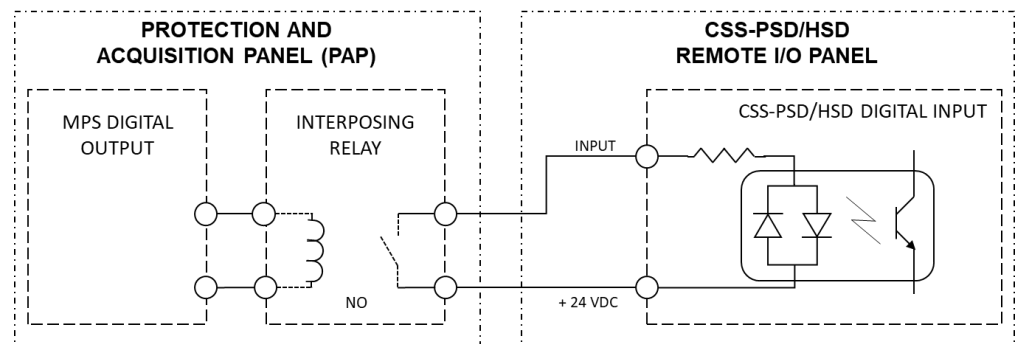



FIGURE 1 - INTERPOSING RELAY FOR SIGNALS FROM MPS TO CSS-PSD/HSD.

4.4.4.7 The sensors of the equipment for which the MANUFACTURER does not indicate the need of vibration trip shall be forwarded to a Dynamic Acquisition Module (DAM) at PAP, which will monitor the variables (acquiring dynamic waveforms) without being responsible for the shutdown. MMS shall monitor this DAM in the same way as the DAM of P2, P2S or P2C PACKAGE UNITS as described in item

	TECHNICAL SPECIFICATION	I-ET-3010.00-5500-854-P4X-001	REV.: G
			SHEET: 16 of 24
	TITLE: MACHINERY MONITORING SYSTEM (MMS)		ESUP
		INTERNAL	

4.5.

4.4.4.8 Whether MPS or DAM will be used for each equipment shall be defined by equipment MANUFACTURER during detail engineering design.

4.4.4.9 MMS shall be supplied with any necessary equipment for interface between DAM and sensors.

4.4.5 If, during project's detailing design phase, the MANUFACTURER indicates that there are no vibration sensors installed at a certain equipment, this machine's other sensors (e.g. temperature) shall be connected to the CSS, and the equipment not be integrated in MMS.

4.4.6 Process variables and data related to winding temperature of electrical motors related to those equipment shall be acquired, via Gigabit Ethernet TCP/IP connection (OPC UA), from the Supervisory and Operation System Data Acquisition LAN (see Table 1).

4.4.7 The construction of the PAP shall be according to I-ET-3010.00-5520-888-P4X-001 – AUTOMATION PANELS. Dimensions of the PAP and number of sections shall be adequate to house all MPS and DAM of the P0 equipment and of equipment that are not PACKAGE UNITS but shall be monitored by the MMS. This information shall be confirmed during project's detailing design phase.

4.5 Machinery Protection System (MPS) and Data Acquisition Module (DAM)

4.5.1 The Machinery Protection Systems (MPS) and Data Acquisition Modules (DAM) shall consist of monitoring equipment capable of reading signals from sensors and transducers. The MPS shall have the additional feature (in relation to the DAM) of being able to send a trip signal (directly to the equipment, in case of P2, P2S or P2C PACKAGE UNITS or to the CSS-PSD / CSS-HSD, in case of P0 type PACKAGE UNITS).

4.5.2 All MPS shall be according to API STD 670.

4.5.3 Each MPS / DAM shall acquire data of more than one different sensors/transducers.

4.5.4 MPS / DAM of P2, P2S or P2C type critical rotating machine are included in the scope of P2, P2S or P2C PACKAGER and shall be installed in the UCP of the PACKAGE UNIT.

4.5.5 MPS / DAM of P0 type critical rotating machine shall be included in the scope of MMS SUPPLIER or INTEGRATOR and shall be installed either in the TOPSIDES PAP or the HULL PAP.

4.5.6 Supplier of the MMS Server Panel shall evaluate all projects of PACKAGE UNITS, being responsible for properly dimensioning MMS to monitor all the available points in all the MPS / DAM of all the PACKAGE UNITS listed in ANNEX A – EQUIPMENT TO BE MONITORED BY THE MMS. License shall cover all available points.

4.5.7 All the vibration and displacement variables shall be collected and stored as dynamic data (waveforms). All proximity sensors (vibration / displacement) shall be configured to have its acquisition rate increased during machine speed transients. License shall cover all of these points.

4.5.8 Equipment defined as P2, P2S or P2C TYPE PACKAGE UNITS in project's technical specification entitled "AUTOMATION INTERFACE OF PACKAGED UNITS" shall have their MPS integrated in the MMS System. Refer to ANNEX A – EQUIPMENT TO BE MONITORED BY THE MMS.

4.5.9 MPS / DAM shall monitor vibration data in the frequency range of 0 up to 15 kHz or more.

4.5.10 For the MPS, radial vibration alarms shall include at least two (2) levels: alarm and shutdown.

4.5.11 The following vibration associated signals shall be made available by MPS:

- Overall vibration (RMS, 0-pk, or pk-pk);
- Proximity probe gap;
- 1X – amplitude;
- 1X – phase;
- 2X – amplitude;
- 2X – phase;
- not-1X - Amplitude;
- Maximum Orbit displacement (Smax).

NOTE: For the Cargo Pumps package the vibration may be made indirectly by the hydraulic power supply. In this case, a module for monitoring of the hydraulic fluid of the pump and a module for monitoring the motors of the HPU that actuates these pumps shall be foreseen.

4.5.12 MPS/DAM shall have enough interface cards to allow the interconnection with the MMS data acquisition server (software and hardware).

4.5.13 Each channel of MPS/DAM shall be supplied with an electronic configurable time delay to avoid activation of alarm during transient signals.

4.5.14 A controlled access set point multiplier function shall be provided with actuation by an external contact closure which causes the alarm (alert) and shut down (danger) set points to be multiplied by a factor.

4.5.15 Each monitor channel of MPS/DAM shall be capable of continuously comparing the input signal to warning set points. MPS warning system shall comprise at least two (2) levels: alarm and shutdown. DAM Warning system shall comprise at least one alarm level,

4.5.16 All signals from MPS/DAM cards shall be enabled to send data to MMS.

4.5.17 All vibration signals (including displacement and accelerometers) sent to MPS shall be available with buffer signal output.

4.5.18 MPS of package units shall be housed in PACKAGE UCP. It is not acceptable to place it in PAP.

4.6 Communication

4.6.1 The communication among MMS Server Panels, Workstations and PAP shall be done by means of twisted pair cable, if the equipment are installed in the same ambience, or by fiber optics, if the equipment interconnected are in different ambience. These interconnections shall follow the project specific documentation, e. g., NETWORK INTERCONNECTION DIAGRAM.

4.6.2 In order to connect the MPS to the MMS, the following interfaces are required:

- 4.6.2.1 For P0 type PACKAGE UNITS, the rotating machines shall be provided with vibration and temperature sensors/transducers connected to junction boxes installed at field. Cables from the junction box to the PAP shall connect the sensor signals to their respective MPS or DAM in the MMS Protection and Acquisition Panel.

4.6.2.2 For P2, P2S or P2C type PACKAGE UNITS, the MPS are furnished with communication resource and shall be connected to MMS Server Panel through dedicated MMS protocol.

4.6.3 All MMS networks (MMS LAN SOS and MMS LAN PCKG) shall follow the requirements of I-ET-3010.00-5520-800-P4X-004 - AUTOMATION NETWORK REQUIREMENTS, and project specific documentation (e.g. NETWORK INTERCONNECTION DIAGRAM and AUTOMATION NETWORK DESCRIPTION). MMS LAN SOS and MMS LAN PCKG shall have the same model/brand as Package entry switches.

4.7 MMS Automation Diagram

4.7.1 FIGURE 2 – MMS ARCHITECTURE shows how the interconnection between MMS equipment and UNIT’s Automation Architecture shall be established. See ANNEX B – MMS ARCHITECTURE IN CASE OF MULTIPLE SUPPLIERS for the case of multiple suppliers.

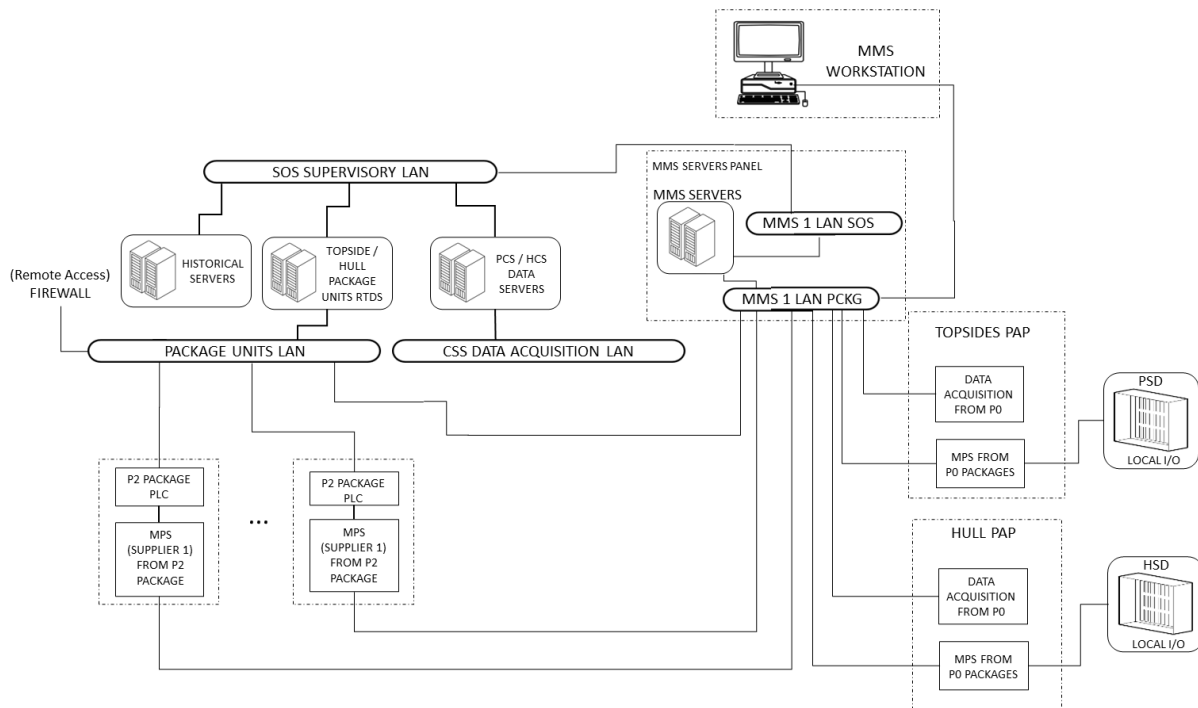

* ALL PANELS SHALL EXCHANGE DIAGNOSTIC SIGNALS WITH CSS-PSD/HSD

FIGURE 2 – MMS ARCHITECTURE

4.8 Onshore Access to the MMS Server

4.8.1 Remote access to the MMS Servers from a microcomputer onshore shall be according to FIGURE 3. See ANNEX B – MMS ARCHITECTURE IN CASE OF MULTIPLE SUPPLIERS for the case of multiple suppliers.

4.8.2 MMS Servers shall not be accessed directly from a computer connected to the RIC. An intermediate sever in the DMZ shall be used.

4.8.3 The following equipment are not under MMS Scope of supply:

- PACKAGE UNITS LAN SWITCHES
- CORPORATE LAN SWITCHES
- CORPORATE LAN MICROCOMPUTER
- TELECOM FIREWALL

- **AUTOMATION DMZ CLUSTER**

However, any software, virtual machines, drivers installed in these equipment are under MMS SCOPE OF SUPPLY. Any configuration required in these equipment are also under MMS SCOPE OF SUPPLY.

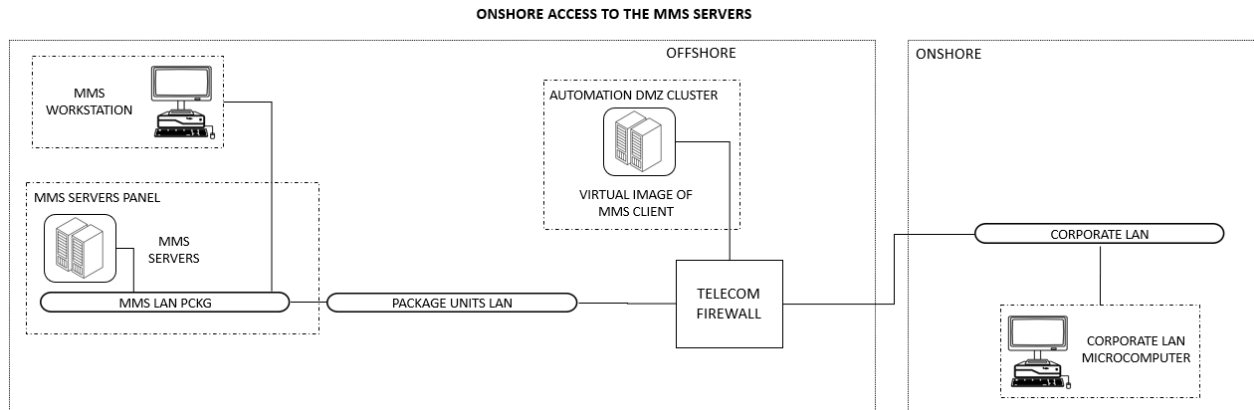



FIGURE 3 – ONSHORE ACCESS TO THE MMS SERVER

5 DOCUMENTATION

- 5.1 Complete documentation of the MMS covering all devices, software and services shall be supplied with the proposal for approval and for final acceptance.
- 5.2 There shall be supplied with the proposal at least the following technical documents:
 - Technical specifications, comprising: system, equipment, instruments (if any), accessories, cables, materials and software;
 - Design calculation reports (including server dimensioning, number of switch ports estimation, number and type of monitored points, etc.);
 - Datasheets and drawings of all equipment and its internal components;
 - Installation drawings including general arrangement, detailed lay-out, electrical diagrams, wiring diagrams, cable list, material list, equipment list and interconnection diagrams;
 - Utilities consumption list, electrical loads list and reports describing the method used to calculate each equipment's installed power, power consumption and heat dissipation. If any power factors or utilization factors are used, these shall also be informed;
 - Weight control report describing the weight of each equipment and its internal components;
 - Test procedures, training course program, services schedule;
 - Programming tools and manuals, system reports, system diagnosis, etc.
- 5.3 It shall be provided detailed information regarding the asset condition monitoring software for technical evaluation. A list of all capability items shall be provided with diagnosis description for technical evaluation.

	TECHNICAL SPECIFICATION	I-ET-3010.00-5500-854-P4X-001	REV.: G
			SHEET: 20 of 24
	TITLE: MACHINERY MONITORING SYSTEM (MMS)		ESUP

- 5.4 Complete MMS certified documentation, including operation manual, installation manual and maintenance manual shall be provided, in the number of digital media (USB flash drive) copies requested at Bid documents, including all programming and configurations tools. This documentation shall include, among others, complete documentation for all MPS/DAM (including those of PACKAGE UNITS), of all sensors installed in each equipment monitored by the MMS, and all data and performance curves necessary to be implemented or analyzed by the MMS for system configuration.
- 5.5 All keys, drivers, manuals and licenses of all software inside scope of MMS shall be supplied. No software access restrictions will be accepted by PETROBRAS.

6 ACCEPTANCE TESTS

- 6.1 The following tests, besides the tests required at I-ET-3010.00-1200-800-P4X-002 – AUTOMATION, CONTROL AND INSTRUMENTATION ON PACKAGE UNITS, where applicable, shall be performed at supplier installations (FAT) prior to delivery:
- Input and output signal verification;
 - Communication within panels;
 - Communication with the MMS Workstation;
 - MMS supervisory software's adequate functioning once installed;
 - Complete and adequate configuration of all measurement points;
 - CSV file extraction of logs, trends etc.
- 6.2 A Design Calculation Report demonstrating that the system will perform adequately under various conditions of ventilation, covering all possible severe operation conditions of the UNIT shall be provided. This document shall be submitted to and approved by PETROBRAS.
- 6.3 SIT shall be executed with all MMS components interconnected with:
- each other;
 - PACKAGE UNIT LAN;
 - SOS LAN;
 - MPS/DAM of monitored equipment;
 - field sensors.
- 6.4 It shall submit to PETROBRAS, for approval, detailed FAT, SAT and SIT programs.

7 ACCEPTANCE TESTS

- 7.1 On completion of FAT all equipment shall be prepared for shipment and storage.
- 7.2 Equipment supplied loose shall be packed and crated for transport. In addition, if some rack equipment is susceptible to transport damage, it shall be removed from the system rack for separate packing and crating.
- 7.3 In order to prevent corrosion, VCI shall be used adequately, where applicable, as part of preparation for shipment and storage instead of desiccants such as silica gel. The later shall be used only in cases where VCI is not applicable. Both VCI and desiccants shall not be used together for protecting the same compartment.

ANNEX A – EQUIPMENT TO BE MONITORED BY THE MMS

Equipment PACKAGE UNIT classification shall be consulted in project's technical specification entitled "AUTOMATION INTERFACE OF PACKAGED UNITS".

The sensor and transducer requirements for each equipment shall be consulted in equipment's technical specification. Some equipment may not have their own technical specification and are, instead, described in technical specification of the unit of which they are part of.

Equipment listed in Table 2 and Table 3 shall be monitored by the MMS.

For further details regarding MMS monitoring of each package, consult the package's documentation. As an example (this is a non-exhaustive list), the following documents have further details regarding MMS of each package:

- I-ET-3010.00-5147-332-P4X-001 (Main Turbogenerator Units)
- I-ET-3010.00-1225-323-P4X-001 (Vapor Recovery Units)
- I-ET-3010.00-1200-321-P4X-001 (Main Gas Compression Units)
- I-ET-3010.00-1200-321-P4X-001 (Exportation Gas Compression Units)
- I-ET-3010.00-1200-321-P4X-001 (Injection Gas Compression Units)
- I-ET-3010.00-1200-321-P4X-001 (CO2 Compression Units)
- I-ET-3010.00-1200-321-P4X-001 (GDU Blower/Compressor)

Table 2 – Hull Systems Equipment that shall be monitored by the MMS

HULL SYSTEMS EQUIPMENT
ENGINE ROOM COOLING SEA WATER PUMP
ENGINE ROOM CENTRAL FRESH WATER COOLING CIRCULATING PUMP
DIESEL OIL SERVICE PUMP
INERT GAS SEAL PUMP
INERT GAS GENERATOR SEA WATER PUMP
CARGO PUMPS PACKAGE (NOTE 1)
INSTRUMENT / SERVICE AIR COMPRESSION UNIT
HULL GENERATOR
OTHER EQUIPMENT WITH VIBRATION SENSORS MONITORED AND/OR TRIPPED by CSS/PAP/UCP

Note 1: For the Cargo Pumps package the vibration may be made indirectly by the hydraulic power supply. In this case, a module for monitoring of the hydraulic fluid of the pump and a module for monitoring the motors of the HPU that actuates these pumps shall be foreseen.



TITLE:

MACHINERY MONITORING SYSTEM (MMS)

SHEET: 22 of 24

ESUP

INTERNAL

Table 3 - Topsides Equipment that shall be monitored by the MMS

TOPSIDES EQUIPMENT
SEA WATER LIFT PUMPS (NOTE 1)
SEA WATER LIFT BOOSTER PUMPS
HOT WATER CIRCULATION PUMPS
COOLING WATER CIRCULATION PUMP - CLASSIFIED AREA
COOLING WATER CIRCULATION PUMP - NON-CLASSIFIED AREA
BOOSTER INJECTION WATER PUMPS
MAIN INJECTION WATER PUMPS
MAIN TURBOGENERATOR UNITS
STEAM TURBOGENERATOR
STEAM GENERATOR FEEDWATER PUMP
VAPOR RECOVERY UNITS
MAIN GAS COMPRESSION UNITS
EXPORTATION GAS COMPRESSION UNITS
INJECTION GAS COMPRESSION UNITS
DEWPOINT COMPRESSOR
CO2 COMPRESSION UNITS
FGRU AND SLOP TANK COMPRESSORS
ALL GDU BLOWERS/COMPRESSORS (MOLECULAR SIEVE, TEG, TEG REGENERATION, OR OTHERS)
SRU BOOSTER PUMP
PRE-OIL DEHYDRATOR RECIRCULATION WATER PUMP
OIL DEHYDRATOR RECIRCULATION WATER PUMP
OIL TRANSFER PUMP
TEST SEPARATOR PUMP
VACUUM DEAERATION UNIT
STRUCTURAL TANK GAS RECOVERY UNIT
OTHER EQUIPMENT WITH VIBRATION SENSORS MONITORED AND/OR TRIPPED by CSS/PAP/UCP

Note 1: For sea water lift pumps, the minimum monitored parameters are usually the following:

- (Mainly) Temperature of the electric motor windings;
- Electric motor fluid condition monitoring (particle content and humidity).

ANNEX B – MMS ARCHITECTURE IN CASE OF MULTIPLE SUPPLIERS

Equipment PACKAGE UNIT classification shall be consulted in project’s technical specification entitled “AUTOMATION INTERFACE OF PACKAGED UNITS”.

If the MPS of any PACKAGE UNIT is from a second supplier, another MPS Server Panel and MPS Workstation of this same supplier shall be added do the system. The extra equipment shall be inserted into the MMS architecture according to the figure presented in this ANNEX.

If MPS of a third supplier is identified within a PACKAGE UNIT, it shall be inserted into the MMS architecture in the same way as the second MMS supplier equipment described in the figure. This is valid for N suppliers.

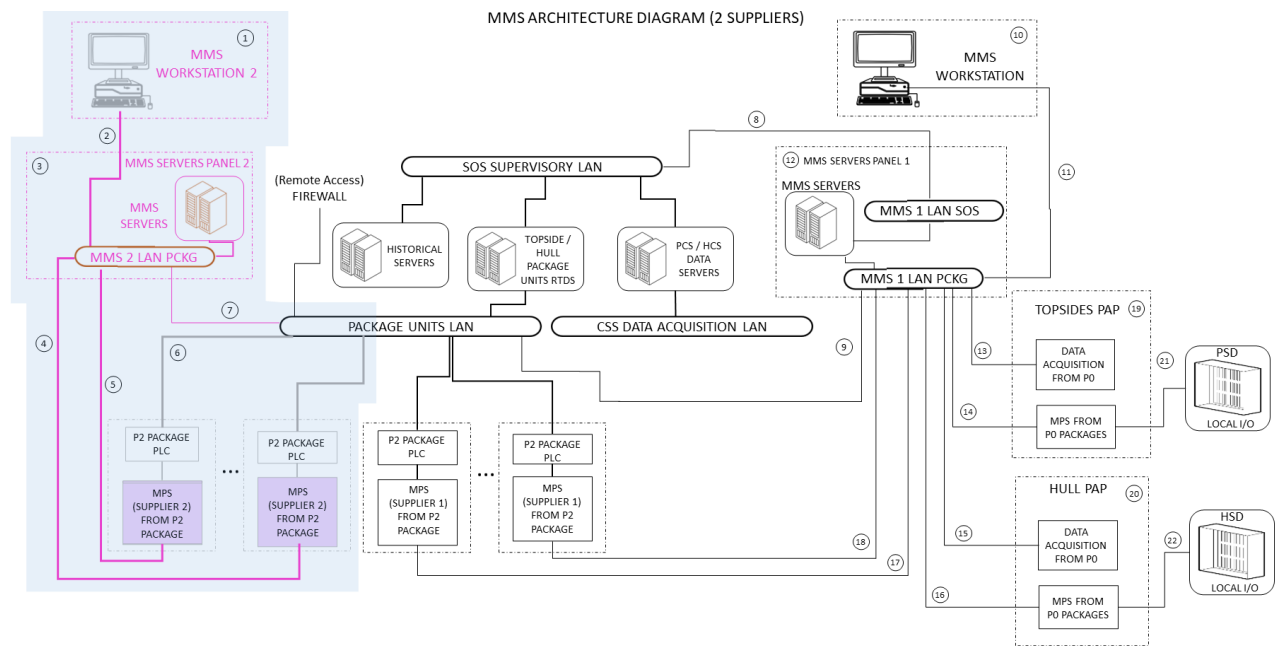

* ALL PANELS SHALL EXCHANGE DIAGNOSTIC SIGNALS WITH CSS-PSD/HSD

FIGURE 4 – OFFSHORE ACCESS TO MULTIPLE MMS SERVERS

Table 4 – MMS Connections and Equipment

ITEM	DESCRIPTION	ITEM	DESCRIPTION
1	MMS WORKSTATION 2	11, 13, 14, 15, 16, 17, 18	CABLES FOR ETHERNET + PROPRIETARY PROTOCOL OF SUPPLIER 1
2, 4, 5	CABLES FOR ETHERNET + PROPRIETARY PROTOCOL OF SUPPLIER 2	12	MMS SERVERS PANEL 1
3	MMS SERVERS PANEL 2	19	TOPSIDES PROTECTION AND ACQUISITION PANEL (PAP) WITH ITS INTERNAL COMPONENTS AND CONNECTIONS
6,7	CABLES FOR GIGABIT ETHERNET	20	HULL SYSTEMS PROTECTION AND ACQUISITION PANEL (PAP) WITH ITS INTERNAL COMPONENTS AND CONNECTIONS
8, 9	CABLES FOR GIGABIT ETHERNET	21	CABLES FOR I/O CONNETIONS BETWEEN MPS UNITS FROM TOPSIDES PAP TO CSS-PSD LOCAL I/O PANEL
10	MMS WORKSTATION 1	22	CABLES FOR I/O CONNETIONS BETWEEN MPS UNITS FROM HULL PAP TO CSS-HSD LOCAL I/O PANEL

TITLE:

MACHINERY MONITORING SYSTEM (MMS)

ESUP

INTERNAL

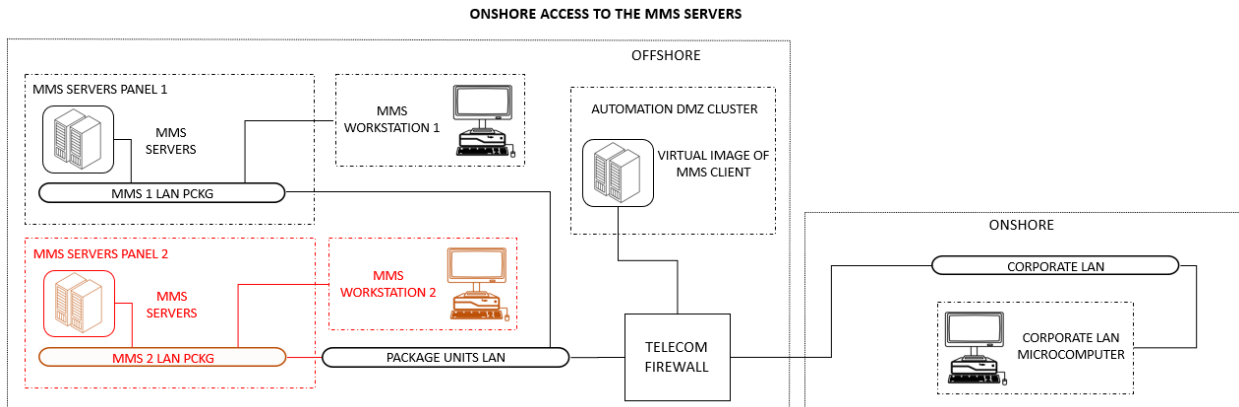

FIGURE 5 – ONSHORE ACCESS TO MULTIPLE MMS SERVERS