	<b>TECHNICAL SPECIFICATION</b>		Nº: I-ET-3010.2Q-1200-200-P4X-001						
	CLIENT: SRGE		SHEET: 1 of 23						
	JOB:								
	AREA:								
SRGE	<b>PIPING SPECIFICATION FOR TOPSIDE</b>		INTERNAL						
			ESUP						
This document is extracted from I-ET-3000.00-1200-200-P4X-001_0									
<b>INDEX OF REVISIONS</b>									
<b>REV.</b>	<b>DESCRIPTION AND/OR REVISED SHEETS</b>								
0	ORIGINAL ISSUE								
	REV. 0	REV. A	REV. B	REV. C	REV. D	REV. E	REV. F	REV. G	REV. H
DATE	04/APR/24								
DESIGN	EEA								
EXECUTION	UPTP								
CHECK	CXDI								
APPROVAL	U32N								
INFORMATION IN THIS DOCUMENT IS PROPERTY OF PETROBRAS, BEING PROHIBITED OUTSIDE OF THEIR PURPOSE									
FORM OWNED TO PETROBRAS N-0381 REV. L									

## INDEX

<b>1</b>	<b>SCOPE.....</b>	<b>3</b>
<b>2</b>	<b>NORMATIVE REFERENCES .....</b>	<b>3</b>
<b>3</b>	<b>REFERENCED PETROBRAS TECHNICAL SPECIFICATIONS.....</b>	<b>7</b>
<b>4</b>	<b>SYMBOLS AND ABBREVIATED TERMS.....</b>	<b>8</b>
<b>5</b>	<b>PIPING TAGGING SYSTEM.....</b>	<b>11</b>
<b>6</b>	<b>PIPING SPECIFICATION CODE RULE.....</b>	<b>12</b>
<b>7</b>	<b>SERVICES FOR TOPSIDE PIPING SPECS.....</b>	<b>13</b>
<b>8</b>	<b>LIST OF TOPSIDE PIPING SPECS.....</b>	<b>15</b>
<b>9</b>	<b>SERVICES FOR HULL PIPING SPECS.....</b>	<b>19</b>
<b>10</b>	<b>LIST OF HULL PIPING SPECS.....</b>	<b>22</b>
<b>11</b>	<b>PIPING MATERIAL SPECIFICATIONS.....</b>	<b>23</b>

### Annex

- A. Valves and Valve Datasheets**
- B. Pipes, Fittings and Accessories and Datasheets**
- C. Typical Arrangement for Drain&Vent and Instruments**
- D. Piping Material Selection for Corrosive HC and Produced Water (cancelled)**
- E. Flange Isolation Kit**
- F. Requirements for Piping internal Coating (cancelled)**
- G. Welding Requirements (cancelled)**
- H. Requirements for FRP Pipes and Fittings**
- J. Piping Weld Inspection (cancelled)**
- K. Pressure-Safety Valves and PSV Datasheets**
- L. Requirements for Line Blanks**

## 1 SCOPE

This Guideline standardizes piping and valves materials for use in oil and gas exploration and production facilities.

This document specifies requirements for acquisition of: pipes, valves, fittings, flanges, gaskets bolts and nuts. Aspects of design, performance, materials, fabrication, testing, inspection, marking, storage, expedition and documentation are covered.

The designer is responsible for selecting the piping material specification (spec) taking into account its limitations, such as: service, pressure and temperature.

## 2 NORMATIVE REFERENCES

Note: The Standards referred herein shall be considered in their latest edition/revision.

API RP 14E - Recommended Practice for Design and Installation of offshore Production Platform Piping Systems.

API SPEC 5L - Specification for Line Pipe.

API 6A - Specification for Wellhead and Christmas Tree Equipment

API SPEC 6D ISO 14313 - Petroleum and Natural Gas Industries – Pipeline Transportation Systems-Pipeline Valves.

API STD 594 - Check Valves: Wafer, Wafer-Lug, and Double Flanged Type.

API STD 598 - Valve Inspection and Testing

API STD 599 - Metal Plug Valves-Flanged, Threaded and Welding Ends

API STD 600 ISO 10434 – Bolted Bonnet Steel Gate Valves for Petroleum and Natural Gas Industries.

API STD 602 - ISO 15671 – Compact Steel Gate Valves – Flanged, Threaded, Welding, and Extended – Body Ends.

API STD 607 - Fire Test for Quarter-turn Valves and Valves Equipped with Nonmetallic Seats

API STD 609 - Butterfly Valves: Double Flanged, Lug and Wafer – Type.

ASME B1.1 - Unified Inch Screw Threads (UN and UNR Thread Form).

ASME B1.20.1 - Pipe Threads, General Purpose (Inch).

ASME B16.1 - Cast Iron Pipe Flanges and Flanged Fittings Classes 25, 125 and 250.

ASME B16.5 - Pipe flanges and flanged fittings NPS 1/2 through NPS 24 metric/inch standard revision e ASME B16.5

ASME B16.9 - Factory-made wrought steel butt welding fittings.

ASME B16.10 - Face-to-face and end-to-end dimensions of valves

ASME B16.11 - Forged Fittings, Socket-Welding and Threaded.

ASME B16.20 - Metallic gaskets for pipe flanges ring-joint, spiral-wound, and jacketed.

ASME B16.21 - Nonmetallic Flat Gaskets for Pipe Flanges.

ASME B16.25 - Butt welding Ends.

ASME B16.28 - Wrought Steel Butt welding Short Radius Elbows and Returns.

ASME B16.34 - Valves – Flanged, threaded and welding end

ASME B16.47 - Large diameter Steel Flanges (NPS 26 through NPS 60).

ASME B16.5 - Pipe Flanges and Flanged Fittings: NPS 1/2 through NPS 24 Metric/Inch Standard

ASME B18.2.2 - Square and Hex Nuts (Inch Series).

ASME B31.3 - Process Piping.

ASME B31.4 - Pipeline Transportation Systems for Liquid Hydrocarbons and Other Liquids

ASME B31.8 - Gas Transmission and Distribution Piping Systems

ASME B36.10 - Welded and Seamless Wrought Steel Pipe.

ASME B36.19 - Stainless Steel Pipe

ASTM A105 - Standard Specification for Carbon Steel Forgings for Piping Applications.

ASTM A106 - Standard Specification for Seamless Carbon Steel Pipe for High-Temperature Service.

ASTM A123 - Standard Specification for Zinc (Hot-Dip Galvanized) Coatings on Iron and Steel Products.

ASTM A126 - Standard Specification for Gray Iron Castings for Valves, Flanges, and Pipe Fittings.

ASTM A182 - Standard Specification for Forged or Rolled Alloy-.Steel Pipe Flanges, Forged Fittings, and Valves and Parts for High-Temperature Service.

ASTM A193 - Standard Specification for Alloy-Steel and Stainless Steel Bolting Materials for High-Temperature Service.

ASTM A194 - Standard specification for carbon and alloy steel nuts for bolts for high pressure or high temperature service, or both.

ASTM A216 - Standard Specification for Steel Castings, Carbon, Suitable for Fusion Welding, High-Temperature Service.

ASTM A234 - Standard Specification for Piping Fittings of Wrought Carbon Steel and Alloy Steel for Moderate and High Temperature Service.

ASTM A269 - Standard Specification for Seamless and Welded Austenitic Stainless Steel Tubing for General Service

ASTM A312 - Standard Specification for Seamless, Welded, and Heavily Cold Worked Austenitic Stainless Steel Pipes.

ASTM A320 - Standard Specification for Alloy-Steel and Stainless Steel Bolting Materials Low High-Temperature Service.

ASTM A333 - Standard Specification for Seamless and Welded Steel Pipe for Low-Temperature Service.

ASTM A350 - Standard Specification for Carbon and Low-Alloy Steel Forgings, Requiring Notch Toughness Testing for Piping Components.

ASTM A351 - Standard Specification for Castings, Austenitic, Austenitic-Ferritic (Duplex), for Pressure-Containing Parts.

ASTM A352 - Standard Specification for Steel Castings, Ferritic and Martensitic, for Pressure-Containing Parts, Suitable for Low-Temperature Service.

ASTM A358 - Standard Specification for Electric-Fusion-Welded Austenitic Chromium-Nickel Stainless Steel Pipe for High-Temperature Service and General Applications

ASTM A403 - Standard Specification for Wrought Austenitic Stainless Steel Piping Fittings.



ASTM A420 - Standard Specification for Piping Fittings of Wrought Carbon Steel and Alloy Steel for Low-Temperature Service.

ASTM A487 - Standard Specification for Steel Castings Suitable for Pressure Service.

ASTM A522 - Standard Specification for Forged or Rolled 8 and 9% Nickel Alloy Steel Flanges, Fittings, Valves, and Parts for Low-Temperature Service

ASTM A536 - Standard Specification for Ductile Iron Castings.

ASTM A564 - Standard Specification for Hot-Rolled and Cold-Finished Age-Hardening Stainless Steel Bars and Shapes.

ASTM A671 - Standard Specification for Electric-Fusion-Welded Steel Pipe for Atmospheric and Lower Temperatures.

ASTM A694 - Standard Specification for Carbon and Alloy Steel Forgings for Pipe Flanges, Fittings, Valves, and Parts for High-Pressure Transmission Service.

ASTM A733 - Standard Specification for Welded and Seamless Carbon Steel and Austenitic Stainless Steel Pipe Nipples

ASTM A790 - Standard Specification for Seamless and Welded Ferritic/Austenitic Stainless Steel Pipe.

ASTM A815 - Standard Specification for Wrought Ferritic, Ferritic/Austenitic, and Martensitic Stainless Steel Piping Fittings.

ASTM A928 - Standard Specification for Ferritic/Austenitic (Duplex) Stainless Steel Pipe Electric Fusion Welded with Addition of Filler Metal

ASTM A995 - Standard Specification for Castings, Austenitic-Ferritic (Duplex) Stainless Steel, for Pressure-Containing Parts

ASTM B62 - Standard Specification for Composition Bronze or Ounce Metal Castings.

ASTM B366 - Standard Specification for Factory-Made Wrought Nickel and Nickel Alloy Fittings

ASTM B444 - Specification for Nickel-Chromium-Molybdenum-Columbium Alloys (UNS N06625 and UNS N06852) and Nickel-Chromium-Molybdenum-Silicon Alloy (UNS N06219) Pipe and Tube

ASTM B564 - Specification for Nickel Alloy Forgings

ASTM B584 - Standard Specification for Copper Alloy Sand Castings for General Applications.

ASTM D1784 - Standard Specification for Rigid Poly (Vinyl Chloride) (PVC) Compounds and Chlorinated Poly (Vinyl Chloride) (CPVC) Compounds.

ASTM D1785 - Standard Specification for Poly (Vinyl Chloride) (PVC) Plastic Pipe, Schedules 40, 80 and 120.

ASTM D2467 - Standard Specification for Poly (Vinyl Chloride) (PVC) Plastic Pipe Fittings, Schedule 80.

ASTM D3567 - Standard Practice for Determining Dimensions of Fiberglass (Glass-Fiber-Reinforced Thermosetting Resin) Pipe and Fittings R (2002).

ASTM D4024 - Standard Specification for Machine Made "Fiberglass" (Glass-Fiber-Reinforced Thermosetting Resin) Flanges (2000).

ASTM F1173 - Standard Specification for Thermosetting Resin Fiberglass Pipe Systems to be used for Marine Applications (2001).

ASTM F1387 - Standard Specification for Performance of Piping and Tubing Mechanically Attached Fittings

ASTM F439 - Standard Specification for Chlorinated Poly (Vinyl Chloride) (CPVC) Plastic Pipe Fittings, Schedule 80.

BSI BS 1873 - Steel Globe and Globe Stop and Check Valves (flanged and butt-welding ends) for the Petroleum, Petrochemical and Allied Industries.

BSI BS 3799 - Steel Pipe Fittings, Screwed and Socket-Welding for the Petroleum Industry.

BSI BS 5152 - Cast Iron Globe and Globe Stop and Check Valves for General Purposes.

BSI BS 5351 - Steel Ball Valves for the Petroleum, Petrochemical and Allied Industries.

BSI BS 5352 - Steel Wedge Gate, Globe and Check Valves 50 mm and Smaller for the Petroleum, Petrochemical and Allied Industries.

EEMUA 144 - 90/10 Copper Nickel Alloy Piping for Offshore Applications. Tubes Seamless and Welded.

EEMUA 145 - 90/10 Copper Nickel Alloy Piping for Offshore Applications. Flanges Composite and Solid.

EEMUA 146 - 90/10 Copper Nickel Alloy Piping for Offshore Applications. Fittings.

IMO A 753(18) - International Maritime Organization - Resolution A 753(18).

ISO 3834-2 – Quality requirements for fusion welding of metallic materials-part 2: comprehensive quality requirements.

ISO 15156 - Petroleum and natural gas industries: Materials for use in H<sub>2</sub>S - containing environments in oil and gas production.

ISO 14692- Petroleum and natural gas industries: Glass-reinforced plastic (GRP) piping.

ISO 17292 - Metal ball valves for petroleum, petrochemical and allied industries.

ISO 21457- Petroleum, petrochemical and natural gas industries – Material selection and corrosion control for oil and gas production systems.

ISO 27509- Petroleum and natural gas industries: Compact Flanged connections with IX seal ring (First Edition).

MSS SP-6 - Standard Finishes for Contact Faces de Pipe Flanges and Connecting-End Flanges of Valves and Fittings.

MSS SP-70 - Cast Iron Gate Valves, Flanged and Threaded Ends.

MSS SP-71 - Gray Iron Swing Check Valves, Flanged and Threaded Ends.

MSS SP-72 - Ball Valves with Flanged or Butt-Welding Ends for General Service.

MSS SP-75 – High-Strength, Wrought, Butt-Welding Fittings.

MSS SP-80 - Bronze Gate, Globe, Angle and Check Valves.

MSS SP-83 - Steel Pipe Unions, Socket-Welding and Threaded.

MSS SP-88 - Diaphragm Type Valves.

MSS SP-95 - Swage (d) Nipples and Bull Plugs.

MSS SP-97 – Integrally Reinforced Forged Branch Outlet Fittings – Socket Welding, Threaded, and Buttwelding Ends.

NBR 15827 - Industrial Valves for Installations of Exploration, Production, Refining and Transport of Petroleum Products - Requirements for Design and Prototype Test.

NORSOK M-001 - Materials Selection

### **3 REFERENCED PETROBRAS TECHNICAL SPECIFICATIONS**

The technical specifications below are mandatory for all specs:

I-ET-3010.00-1200-200-P4X-001 - MINIMUM REQUIREMENTS FOR PIPING MECHANICAL DESIGN AND LAYOUT.

I-ET-3010.00-1200-200-P4X-002 - REQUIREMENTS FOR PIPING FLEXIBILITY AND STRESS ANALYSIS

I-ET-3010.00-1200-200-P4X-003 - DESIGN, CONSTRUCTION AND ASSEMBLY OF FRP PIPING

I-ET-3010.00-1200-200-P4X-004 - REQUIREMENTS FOR PIPING SUPPORT

I-ET-3010.00-1200-200-P4X-005 - SUPPLEMENTARY REQUIREMENTS FOR DSS AND SDSS UNDER CATHODIC PROTECTION

I-ET-3010.00-1200-200-P4X-115 - REQUIREMENTS FOR PIPING FABRICATION ASSEMBLY INSPECTION AND COMMISSIONING

I-ET-3010.00-1200-200-P4X-116 - REQUIREMENTS FOR BOLTED JOINTS ASSEMBLY AND MANAGEMENT

I-ET-3010.00-1200-295-P4X-001 - REQUIREMENTS FOR PIG LAUNCHER AND RECEIVER DESIGN

I-ET-3010.00-1200-800-P4X-015 - REQUIREMENTS FOR TUBING AND FITTING (ALIGNED TO IOGP-JIP33 S-716)

I-ET-3010.00-1200-955-P4X-001 – WELDING

I-ET-3010.00-1200-955-P4X-002 - REQUIREMENTS FOR WELDING INSPECTION

I-ET-3010.00-1200-956-P4X-002 - GENERAL PAINTING

I-ET-3010.00-1200-956-P4X-003 - THERMAL SPRAY COATING APPLICATION OF ALUMINUM

## 4 SYMBOLS AND ABBREVIATED TERMS

For the purposes of this document, the following symbols and abbreviated terms apply:

AISI	American Iron and Steel Institute
API	American Petroleum Institute
ASME	American Society of Mechanical Engineering
ASTM	American Society For Testing And Materials
BE	Beveled Ends
BF	Butt Strap
BLE	Beveled Large Ends.
BS	Bell Spigot
CL	Class
CPVC	Chlorinated Polyvinyl Chloride
Cr	Chrome
CS	Carbon Steel
CuNi	Copper-Nickel
DSS	Duplex Stainless Steel
EEMUA	Engineering Equipment and Materials Users Association
EJ	Elastic Joint
FLG	Flange
FF	Flat Face
FRP	Fiber reinforced plastic
FCAP	Capilar Union Female
FTHD	Threaded Female
GALV	Galvanized
GR	Grade
GRP	Glass Fiber Reinforced Plastic
HC	Half Coupling
HEX	Hexagonal
IMO	International Maritime Association
IN	Inch
LTCS	Low Temperature Carbon Steel
MAX	Maximum
MCap	Capillary Union Male
MSS	Manufacturers Standardization Society of the Valve and Fittings Industry

MTHD	Threaded Male
NACE	National Association of Corrosion Engineers
NPT	National Pipe Thread (Thread ASME B1.20.1)
NSFHT	National Standard Fire Hose Thread (Thread)
Org coat	Organic Coated
PBE	Plain Both Ends
PE	Plain Ends
PSE	Plain Short Ends.
PSI	Pounds per square inch
PTFE	Polytetrafluoroethylene
PVC	Polyvinyl Chloride
RF	Raised Face
RJ	Rigid Joint
RTEE	Reduction Tee
RTJ	Ring Type Joint
SCH	Schedule
SDL	Saddle
SDSS	Super duplex Stainless Steel
SDV	Shut Down Valve
SML	Seamless
SOC	Sockolet
SPEC	Piping Material Specification
SS	Stainless Steel
STD	Standard
SW	Socket Weld
TBE	Threaded Both Ends
TEE	Tee
THD	Threaded
UNS	Unified Numbering System
VAG	Needle Valve
VAGI	Instrumentation Needle Valve
VAX	Axial Valve
VBO	Butterfly Valve
VDE	Double Ball valve

VDI	Diaphragm Valve
VES	Ball Valve
VESI	Instrumentation Ball Valve
VGA	Gate Valve
VGL	Globe Valve
VMA	Plug valve
VPVC	Plastic valve
VRE	Check Valve
WOL	Weldolet
XS	Extra Strong
XXS	Double Extra Strong
WLD	Welded
WN	Weld Neck
WOL	Weldolet
WPS	Welding Procedure Specification
WPQR	Welding Procedure Qualification Record

## 5 PIPING TAGGING SYSTEM

### GENERAL

### **A–B–C–D–E**

#### **A – Nominal Pipe Size**

Non-Integer Nominal Pipe Sizes shall be written as Fractions using a dash (“–”) to separate the integer part from the fraction, if necessary. Example: 1/2, 3/4, 1-1/2, 2-1/2.

The number/fraction shall be followed by the double prime symbol (”) representative of inch unit, never two (‘) prime symbols. The sequential numbering need not be modified for diameter changes in the same line.

#### **B – Service Symbols** (as listed in Item 5)

#### **C – Piping Material Specification Code**

#### **D – Sequential Numbering of Line**

Shall consist of sequential number containing exactly 4 digits. The sequential numbering system shall be unique for each service. For example: 1/2"-P-B10-0010 (P-0010) and 8"-P-B14-0010 (P-0010) is not allowed. For example: 6"-P-B10-0010 (P-0010) and 8"-P-B10-0010 (P-0010) is allowed within the same line.

#### **E – Insulation:**

PP – Personal Protection

HC – Heat Conservation

CC – Cold Conservation

NI – Not Insulated (Absence of insulation shall always be represented by “NI”)

Note: Piperun tag shall not contain any spaces between characters

### EXAMPLE OF PIPING TAG

**1–1/2”–P–B10–0010–HC**

**Nominal Pipe Size:** 1 1/2 inch

**Service:** P - Process

**Piping Material Specification:** B10

**Sequential Numbering:** 0010

**Insulation:** Heat Conservation

### PIPELINE TAGGING FOR 3D MODELLING

### **B–D**

For 3D modelling, where Pipeline tagging is also required, it shall consist only of Service and sequential. Additional information regarding nominal pipe size, specification and insulation shall be associated with the piperun. Example of pipeline tag:

**P–0010**

Service: Process (non-corrosive Hydrocarbon)

Sequential Numbering: 0010

## 6 PIPING SPECIFICATION CODE RULE

SPEC CODE RULE: XYYZ			
Material	Code YY	Pressure Class or Type	Code X
Carbon Steel API 5L, 1,6mm	1	125	A
Stainless Steel 316/316L	3	150	B
Carbon Steel API 5L, 1,6mm	4	300	C
Carbon Steel API 5L, 3,2mm	5	600	E
Low Temperature Carbon Steel ASTM A333 Gr6 e ASTM	6	900	F
Cu-Ni 90/10	7	1500	G
Galvanized Carbon Steel API 5L	8	2500	H
Carbon Steel API 5L, 3,2mm	9	10000	J
Carbon Steel API 5L, 1,6mm	10	Gasket Mechanical Coupling (GMC)	R
Organic Coated Carbon Steel API 5L	11	Mechanically Attached Fittings (MAF)	S
Super Duplex Steel UNS S32760	12	Tubing	T
Organic Coated Carbon Steel API 5L	14		
Duplex Steel UNS S31803	16	Other	Code Z
Carbon Steel API 5L, 6,4mm	17	Reduced Pressure	R
Organic Coated Carbon Steel API 5L	18	ASME B31.4 or B31.8	P
Low Temperature Carbon Steel ASTM A333 Gr6 e ASTM	19	Hull Piping Spec.	H
PVC	20	Option lower pressure	A
CPVC	21	Option higher pressure	B
FRP 90°C 10 bar	22		
FRP 90°C 16 bar	23		
FRP 120°C 16 bar	24		
RPVC	25		
FRP 120°C 16 bar	26		
FRP 85°C 16 bar	27		
Inconel 625 clad Carbon Steel API 5L	30		
Alloy Steel 9Ni ASTM A 333 Gr8	31		
Inconel 625 clad Alloy Steel 3 1/2Ni ASTM A 333 Gr3	32		
Inconel clad Alloy Steel Aço Liga 9Ni ASTM A 333 Gr8	33		
Alloy P22	34		
Inconel 625 UNS N06625	40		
Stainless Steel 310H	50		
Stainless Steel 316/316L	51		
Carbon Steel API 5L, 1,6mm	52		
6% Molybdenum	60		



## 7 SERVICES FOR TOPSIDE PIPING SPECS

Code	Service	Specs
ADW	Aerated Dilution Water	B11, B23
AM	Amine	B10, B16, B3, B9, C10, C16, E10, E16, E3
BG	Inert Gas	B1, B3, B10, C10, E10, F10, G10, R3B, R3C, R9B, R9C, S3B, S3C, S9B, S9C
CHW	Chilled Water	B1, B10, B20, R9B, R9C, S9B, S9C
CI	Chemical Injection (non-corrosive)	B1, B10, C10, E10, F10, G10, S9B, S9C, T12, T3,
CI2	DBNPA Biocide	B27
CN	Sodium Hypochlorite	B14, B20, B27
CNI	Corrosive Chemical Injection (Except Sodium Hypochlorite)	B3, C3, E3, F3, G3, H16, H3, J12, S3B, S3C, T12, T3,
D	Diesel	B10, B3, C10, C3, H10
DA	Open Drain	B14, B22, B23, B25, B9, R9B, R9C, S9B, S9C
DF	Closed Drain (Non-Corrosive hydrocarbon)	B1, B10
DFC	Closed Drain (Corrosive Hydrocarbon)	B9, G16
DO	Carbon Dioxide (DRY)	C3, E3, C8, E8
DOH	Carbon Dioxide w/ Hydrocarbon	J12P, J31, J31P
DW	Distilled Water	B3, R3B, R3C, S3B, S3C
F	Safety System and Flare	B10, B12, B16, B19, B3, B30, B50, B6, B9, C3, C6
FG	Fuel Gas	B10, B19, B3, B6, C10, C3, E10, E3, E6, F10, F3, G3
FL	Foam Line	B1, B10, B7, B7R
FLC	Concentrated Foam	B3
FP	Production and Drilling Fluid	B5, C5, E5, F5, G5, H5
FW	Fire Water (Sea Water)	B24, B7, B7R, S7
G	Glycol	B10, B3, B6, C10, C3, C6, E10, E3, E6, F10, F3, G10, G3, G6, H6
GL	Refrigerated Liquefied Petroleum Gases in Low Temperature	B6, C6, E6, F6, G6
H	Hydraulic Fluid	B3, C3, E3, F3, G3, H3, S3B, S3C
HF	Hot Fluid	B4, C4
HWP	Process Heating Water	B4, C4, E4
HWU	Utility Heating Water	B21, B22, B23, B4
IA	Instrumentation Air	B3, G3, R3B, R3C, S3B, S3C

Code	Service	Specs
<b>IG</b>	Instrumentation Gas	B3
<b>IGN</b>	Ignition Line	B3
<b>IN</b>	Instrumentation Nitrogen	B3, R3B, R3C, S3B, S3C
<b>IW</b>	De-Aerated Sea Water Injection	B1, B10, B14, B23, C10, C14, C30, E10, E14, F10, F14, G10, G14, H12, H30
<b>IWC</b>	Aerated Sea Water Injection	B14, B22, B23
<b>JF</b>	Helicopter Refueling	B3
<b>OL</b>	Lubricating Oil	B10, R9B, R9C, S9B, S9C
<b>P</b>	Process (non-corrosive hydrocarbon)	B10, B6, C10, C10P, C6, E10, E3, E6, F10, F10P, F3, F6, G10, G10P, G3, G6, H10, H10P, H10R, H12, H12P, H3, H31, H6, J10, J12, J12P, J31, J31P, J40, J40P
<b>PC</b>	Process (Corrosive Hydrocarbon)	B11, B12, B16, B17, B19, B3, B30, B9, C12, C16, C19, C3, C30, C9, E16, E17, E19, E3, E30, E32, E9, F16, F3, F30, F32, G12, G12P, G16, G16P, G19, G3, H12, H12P, H16, H3, H30, H30P, H31, H33, J12, J12P, J40, J40P
<b>PCW</b>	Produced water	B11, B12, B25, B26, C11, C12, C30, E11, F11, G11, H11
<b>PW</b>	Potable Water	B20, B3, R3B, R3C, S3B, S3C
<b>PWH</b>	Hot Fresh Water	B21, B22, B23, B3, S3B, S3C
<b>RF</b>	Refrigerant Fluid	B10, C10
<b>S</b>	Steam	B4, C4, E4, F4, G4, S9B, S9C
<b>SA</b>	Service Air	B1, B10, C10, R9B, R9C, S9B, S9C
<b>SC</b>	Steam Condensate	B4, C4, E4, F4, G4, S9B, S9C
<b>SFW</b>	Fire Water (Fresh Water)	A4
<b>SN</b>	Start-up Nitrogen	B1, B10, C10, R9B, R9C, S9B, S9C
<b>STA</b>	Start-up Air	C10H
<b>SW</b>	Sea water	B14, B22, B23, B7R, C14, C23
<b>W</b>	Industrial water	B1, B10, B20, B22, B23, B3, C10, E10, F10, G10, H10, R9B, R9C, S9B, S9C

## 8 LIST OF TOPSIDE PIPING SPECS

SPEC	REV	PRESSURE CLASS	CORROSION ALLOWANCE (mm)	MIN TEMP (°C)	MAX TEMP (°C)	PIPE MATERIAL	SERVICE CODE
A4	S	125	1.6 mm	65	90	Carbon Steel	SFW
B1	0	150	1.6 mm	0	100	Carbon Steel	BG CHW CI DF FL IW SA SN W
B3	K	150	-	-100	260	SS 316/316L	AM BG CNI D DW F FG FLC G H IA IG IN JF PC PW PWH W
B4	L	150	1.6 mm	0	300	Carbon Steel	HF HWP HWU S SC
B5	J	150	3.2 mm	0	90	Carbon Steel	FP
B6	N	150	1.6 mm	-46	240	Low Temp CS	F FG G GL P
B7	I	20 bar	-	0	75	Copper-Nickel	FL FW
B9	O	150	3.2 mm	-29	240	Carbon Steel	AM DA DFC F PC
B10	N	150	1.6 mm	-29	210	Carbon Steel	AM BG CHW CI D DF F FG FL G IW OL P SA RF SN W
B11	F	150	-	0	150	Organic Coat CS	ADW PC PCW
B12	L	150	-	0	140	Super Duplex	F PC PCW
B14	H	150	-	0	70	Organic Coat CS	CN DA IW IWC SW
B16	E	150	-	-46	130	Duplex	AM F PC
B17	E	150	6.4 mm	0	120	Carbon Steel	PC
B19	E	150	3.2 mm	-46	200	Low Temp CS	F FG PC
B20	E	-	-	23	40	PVC	CHW CN PW W
B21	C	-	-	27	80	CPVC	HWU PWH
B22	F	10 bar	-	90	90	FRP	DA HWU IWC PWH SW W
B23	G	16 bar	-	90	90	FRP	ADW DA HWU IW IWC PWH SW W
B24	E	16 bar	-	120	120	FRP	FW
B25	F	16 bar	-	20	60	RPVC	DA PCW
B26	A	16 bar	-	120	120	FRP	PCW
B27	A	16 bar	-	85	85	FRP	CI2 CN
B30	C	150	-	0	240	CS Inconel Clad.	F PC
B50	0	150	-	38	538	SS 310H	F
B7R	L	16 bar	-	0	75	Copper-Nickel	FL FW SW
C3	H	300	-	-100	150	SS 316/316L	CNI D F FG G H PC
C4	E	300	1.6 mm	0	350	Carbon Steel	HF HWP S SC
C5	D	300	3.2 mm	0	90	Carbon Steel	FP
C6	L	300	1.6 mm	-46	110	Low Temp CS	F G GL P
C8	F	300	-	-18	54	Galv. CS	DO
C9	M	300	3.2 mm	0	240	Carbon Steel	PC
C10	L	300	1.6 mm	0	240	Carbon Steel	AM BG CI D FG G IW P RF SA SN W

SPEC	REV	PRESSURE CLASS	CORROSION ALLOWANCE (mm)	MIN TEMP (°C)	MAX TEMP (°C)	PIPE MATERIAL	SERVICE CODE
C10P	B	300	1.6 mm	0	110	Carbon Steel	P
C11	E	300	-	0	120	Organic Coat CS	PCW
C12	L	300	-	0	140	Super Duplex	PC PCW
C14	F	300	-	0	90	Organic Coat CS	IW SW
C16	F	300	-	-46	130	Duplex	AM PC
C19	0	300	3.2 mm	-46	200	Low Temp CS	PC
C23	0	25 bar	-	90	90	FRP	SW
C30	E	300	-	-20	200	CS Inconel Clad.	IW PC PCW
C32		300	-	-50	200	3.5Ni InconelClad	PC
E3	I	600	-	-100	200	SS 316/316L	AM CNI D FG G H P PC
E4	D	600	1.6 mm	0	350	Carbon Steel	HWP S SC
E5	D	600	3.2 mm	0	90	Carbon Steel	FP
E6	L	600	1.6 mm	-46	180	Low Temp CS	FG G GL P
E8	G	600	-	-18	54	Galv. CS	DO
E9	L	600	3.2 mm	0	150	Carbon Steel	PC
E10	I	600	1.6 mm	-20	210	Carbon Steel	AM BG CI FG G IW P W
E11	D	600	-	0	150	Organic Coat CS	PCW
E14	E	600	-	0	70	Organic Coat CS	IW
E16	F	600	-	-46	130	Duplex	AM PC
E17	C	600	6.4 mm	0	90	Carbon Steel	PC
E19	0	600	3.2 mm	-46	180	Low Temp CS	PC
E30	E	600	-	-20	200	CS Inconel Clad.	PC
E32	E	600	-	-55	330	3.5Ni InconelClad	PC
F3	H	900	-	-100	200	SS 316/316L	CNI D FG G H P PC
F4	D	900	1.6 mm	0	350	Carbon Steel	S SC
F5	C	900	3.2 mm	0	90	Carbon Steel	FP
F6	K	900	1.6 mm	-46	320	Low Temp CS	GL P
F10	I	900	1.6 mm	-20	200	Carbon Steel	BG CI FG G IW P W
F10P	A	900	1.6 mm	-20	120	Carbon Steel	P
F11	B	900	-	0	90	Organic Coat CS	PCW
F14	D	900	-	0	70	Organic Coat CS	IW
F16	B	900	-	-46	70	Duplex	PC
F30	B	900	-	0	190	CS Inconel Clad.	PC
F32	C	900	-	-55	320	3.5Ni InconelClad	PC
G3	K	1500	-	-100	210	SS 316/316L	CNI D FG G H IA P PC

SPEC	REV	PRESSURE CLASS	CORROSION ALLOWANCE (mm)	MIN TEMP (°C)	MAX TEMP (°C)	PIPE MATERIAL	SERVICE CODE
G4	C	1500	1.6 mm	0	350	Carbon Steel	S SC
G5	C	1500	3.2 mm	0	90	Carbon Steel	FP
G6	H	1500	1.6 mm	-46	160	Low Temp CS	G GL P
G10	H	1500	1.6 mm	-20	200	Carbon Steel	BG CI G IW P W
G10P	H	1500	1.6 mm	0	110	Carbon Steel	P
G11	F	1500	-	0	90	Organic Coat CS	PCW
G12	F	1500	-	-46	90	Super Duplex	PC
G12P	D	1500	-	-46	90	Super Duplex	PC
G14	D	1500	-	0	70	Organic Coat CS	IW
G16	C	1500	-	-46	130	Duplex	DFC PC
G16P	C	1500	-	-46	130	Duplex	PC
G19	C	1500	3.2 mm	-46	70	Low Temp CS	PC
H3	H	2500	-	-100	150	SS 316/316L	CNI H P PC
H5	D	2500	3.2 mm	0	90	Carbon Steel	FP
H6	D	2500	1.6 mm	-46	180	Low Temp CS	G P
H10	I	2500	1.6 mm	-20	175	Carbon Steel	D P W
H10P	G	2500	1.6 mm	0	110	Carbon Steel	P
H11	E	2500	-	0	90	Organic Coat CS	PCW
H12	C	2500	-	-50	115	Super Duplex	IW P PC
H12P	B	2500	-	-50	115	Super Duplex	P PC
H16	C	2500	-	-50	130	Duplex	CNI PC
H30	G	2500	-	-20	115	CS Inconel Clad.	IW PC
H30P	F	2500	-	-20	115	CS Inconel Clad.	PC
H31	B	2500	1.6 mm	-100	93	9Ni	P PC
H33	B	2500	1.6 mm	-50	93	9Ni Inconel Clad.	PC
J10		10000	1.6 mm	0	204	Carbon Steel	P
J12	E	10000	-	-50	100	Super Duplex	CNI P PC
J12P	A	10000	-	-50	100	Super Duplex	DOH P PC
J31	F	10000	1.6 mm	-100	93	9Ni	DOH P
J31P	F	10000	1.6 mm	-100	93	9Ni	DOH P
J40	D	10000	-	-100	155	Inconel	P PC
J40P	0	10000	-	-100	155	Inconel	P PC
R3B	0	150	-	0	60	SS316/316L	BG DW IA IN PW
R3C	0	300	-	0	60	SS316/316L	BG DW IA IN PW
R9B	0	150	1.6 mm	0	70	Carbon Steel	BG CHW DA OL SA SN W

SPEC	REV	PRESSURE CLASS	CORROSION ALLOWANCE (mm)	MIN TEMP (°C)	MAX TEMP (°C)	PIPE MATERIAL	SERVICE CODE
R9C	0	300	1.6 mm	0	70	Carbon Steel	BG CHW DA OL SA SN W
S3B	0	150	-	0	60	SS316/316L	BG CNI DW H IA IN PW PWH
S3C	0	300	-	0	60	SS316/316L	BG CNI DW H IA IN PW PWH
S7	A	20 bar	-	0	75	Copper-Nickel	FW
S9B	0	150	1.6 mm	0	100	Carbon Steel	BG CHW CI DA OL S SA SC SN W
S9C	0	300	1.6 mm	0	100	Carbon Steel	BG CHW CI DA OL S SA SC SN W
T3	A	-	-	60	60	Tubing SS316/316L	CI CNI
T12	0	-	-	90	90	Tubing SuperDuplex	CI CNI
T60		-	-	0	60	Tubing 6Mo	CI CNI

## 9 SERVICES FOR HULL PIPING SPECS

CODE	SERVICE	LOCATION	SPECIFICATION
AO	Slop discharge system	Balance line	B16H
		Dropline inside Slop Tanks	B18H
		All system	B14H
BG	Inert Gas	Other Locations	B11H; B10H
		Penetration pieces on maindeck	B18H
		Pipe stack Stripping	B3H
BR	Bilge	All system	B14H
		Bottom Hull Penetration pieces up to intermediate valve.	B18H
BWG	Ballast and General Service	Other location	B14H
		Spool between sea-chests and sea valves	B18H
BWH	Ballast	Lines inside Ballast Tanks(Double Sides, Double Bottom and FWD Peak Tanks)	B23H
		Other Locations	B14H
CHW	Chilled Water	Accommodations	B20H
		If required by classification society	B10H
		All system	B8H
CN	Hypochlorite Injection	All system	B20H
		If required by classification society	B14H
		Sea chest line	B18H
CNI	Corrosive chemical injection (Except Sodium Hypochlorite)	All system	B3H
CV	Cargo and Slop Tanks Closed Venting	All system	B14H, B10H
D	Diesel Oil	All system	B3H, C3H
		Well service system	B10H
DA	Open Drain	Deck scupper	B18H
		Hellideck drainage	B14H
		Oil Coaming Drain Lines	B10H
		All system	B14H
DF	Non corrosive Closed Drain	All System (in the hull)	B10H

CODE	SERVICE	LOCATION	SPECIFICATION
DFC	Corrosive Closed Drain	Side Shell and Bottom Hull Penetration pieces up to intermediate valve of deck seal discharge and inert gas generator scrubber discharge	B18H
		All System (in the hull)	B9H
DO	Carbon Dioxide	All system	B8H, C8H, E8H
DTH	Draught, Trim and Heel Indication System	Bottom Hull Penetration pieces up to intermediate valve.	B18H
		All system	B3H, B7H
DW	Distilled water	All system	B3H
EG	Exhaust Gas	All system	A3H
FG	Fuel Gas	All system	B10H
FL	Diluted Foam Line	Concentrated + sea water	B7H
FLC	Concentrated Foam Line	Concentrated	B3H
FW	Fire Water (Aerated sea water)	All system	B7H
		Overboard line (only for overboard lines inside the hull)	B14H
GW	Grey Water	Accommodations	B20H
		Other Lines	B3H
		Side Shell and Bottom Hull Penetration pieces up to intermediate valve.	B18H
H	Hydraulic Fluid	All system	B3H, C3H, E3H, F3H, G16H, H16H
		Hydraulic Valves Actuating and return lines	T3H
		Hydraulic actuation for all pumps in the Cargo Pumps Package	MKS
IA	Instrumentation Air	All system	B3H
JF	Helicopter Refueling	All system	B3H
OL	Lubricating Oil	All system	B10H
PCG	Cargo	All system	B14H, B15H
		Adjacent to Accommodation	B16H
		Cargo Pumps Header	B10H
PCW	Produced Water	Balance Line and Side Shell Penetration pieces up to intermediate valve.	B18H
		All system	B11H
PLD	Loading	All system	B10H
PW	Potable Water	Accommodation	B20H
		Other Lines	B3H





CODE	SERVICE	LOCATION	SPECIFICATION
PWH	Hot Fresh Water	Accommodation	B21H
		Other Lines	B3H
SA	Service Air	spool piece of sea chest	B18H
	Service Air	All system	B3H
SN	Start Up Nitrogen	All system	B10H
SP	Vent and tank sounding	Other tanks venting	B8H
		Diesel tanks venting	B10H
		Spool between sea-chests and sea valves	B18H
		Diesel and Fresh Water tanks sounding	B3H
		Other tanks and Void spaces sounding	B8H
STA	Starting Air	All system	C10H
		Inert Gas System Blower	B10H
SW	Sea Water	All system	B14H
		Crossovers of Main Engine Room and Pump Room and its branches up to first flange, Side Shell and Bottom Hull Penetration pieces up to intermediate valve.	B18H
		Scrubber overboard	B23H
TC	Tank Cleaning	All system	B18H
TL	Tank level indication	All system	B3H
TR	Tank Recirculation	All system	B14H
		Transference Header between Cargo Pumps Header connection and Offloading Header connection	B10H
W	Fresh Water	Fresh Water Central Cooling	B10H
		Fresh Water Hydrophore - Accommodation	B20H
		Fresh Water Hydrophore - Engine Room and Hull Generator	B3H
		Fresh Water Hydrophore - Other locations	B3H
		From Fresh Water Station up to Storage Tank	B3H
WW	Wast Water	Vacuum Lines	B3H
		Other Lines	B14H
		Side Shell and Bottom Hull Penetration pieces up to intermediate valve.	B18H

## 10 LIST OF HULL PIPING SPECS

SPEC	REV	PRESSURE CLASS	CORROSION ALLOWANCE (mm)	MIN TEMP (°C)	MAX TEMP (°C)	PIPE MATERIAL	SERVICE CODE
A3H	A	-	-	38	510	Stainless Steel	EG
B10H	A	150	1.6 mm	0	100	Carbon Steel	BG CHW CV D DA DF FG OL PLD SN SP STA W TR PCG
B11H	A	150	-	0	70	Organic Coat CS	BG PCW
B14H	A	150	-	0	70	Organic Coat CS	AO BR BWG BWH CN CV DA FW PCG SW TC TR WW
B15H	0	150	6.0 mm	0	100	Mariloy™	PCG
B16H	A	150	-	-46	130	Duplex	AO PCG
B18H	A	150	-	0	70	Organic Coat CS	BG BR BWG CN DA DFC DTH GW PCW SA SP SW WW
B20H	A	-	-	23	40	PVC	CHW CN GW PW W WW
B21H	A	-	-	27	80	CPVC	PWH
B23H	A	16 bar	-	90	90	FRP	BWH SW
B3H	A	150	-	-100	150	SS 316/316L	BG CNI D DTH DW FLC GW H IA JF PW PWH SA SP TL W WW
B7H	A	20 bar	-	0	75	Copper-Nickel	DTH FL FW
B8H	A	150	-	0	50	Galv. CS	CHW DO SP
B9H	A	150	3.2 mm	0	150	Carbon Steel	DFC
C10H	A	300	1.6 mm	0	150	Carbon Steel	STA
C3H	A	300	-	-100	150	SS 316/316L	D H
C8H	A	300	-	-18	54	Galv. CS	DO
E3H	A	600	-	-100	100	SS 316/316L	H
E8H	A	600	-	-18	54	Galv. CS	DO
F3H	A	900	-	-100	150	SS 316/316L	H
G16H	A	1500	-	0	130	Duplex	H
H16H	A	2500	-	0	130	Duplex	H
T3H	A	-	-	60	60	Tubing SS316/316L	CI CNI

## 11 PIPING MATERIAL SPECIFICATIONS

		OFFSHORE PRODUCTION FACILITIES ENGINEERING GUIDELINES	Doc: I-ET-3010.2Q-1200-200-P4X-001	Revision: Rev 0	Sheet 1 of 2
		OFFSHORE PRODUCTION FACILITIES ENGINEERING GUIDELINES			Issued by: SRGE/ESUP



Services (see notes): <b>AM</b> - Amine; <b>BG</b> - Inert Gas; <b>CNI</b> - Corrosive Chemical Injection (Except Sodium Hypochlorite and DBNPA); <b>D</b> - Diesel; <b>DW</b> - Distilled Water; <b>F</b> - Safety System and Flare; <b>FG</b> - Fuel Gas; <b>FLC</b> - Concentrated Foam; <b>G</b> - Glycol; <b>H</b> - Hydraulic Fluid; <b>IA</b> - Instrumentation Air; <b>IG</b> - Instrumentation Gas; <b>IGN</b> - Ignition Line; <b>IN</b> - Instrumentation Nitrogen; <b>JF</b> - Aviation Kerosene; <b>PC</b> - Process (Corrosive Hydrocarbon); <b>PW</b> - Potable Water; <b>BW</b> - Hot Fresh Water; <b>W</b> - Industrial water;	Material: <b>SS 316/316L</b>	Class: <b>150</b>	Standard: <b>B3</b>
--	---------------------------------	----------------------	------------------------

Pressure Rating (see notes)										
Temperature (°C)	-100	38	100	150	250	260				
Max Pressure (barg)	19.0	19.0	16.2	14.8	12.1	11.7				

**Pipes and Fittings (see notes)**

Items		Code	Size	Wall	Class	Ends	Standard	Material					
Pipes	Pipe	T-322	1/2" - 1 1/2"	S-40S	-	PE	ASME B36.19	ASTM A312 TP 316/316L SML					
		T-323	2" - 24"			BE	ASME B36.10/B36.19	ASTM A358 Type 316/316L Cl 1 or 3 WLD					
			26" - 36"						0.375"				
			38" - 44"	0.438"									
Fittings	90 Elbow	C01-43	1/2" - 1 1/2"	-	3000	SW	ASME B16.11	ASTM A182 Gr F316/316L					
	45 Elbow	C02-43											
	Tee	C03-43											
	Cross	C05-43											
	Coupling	C06-43											
	Cap	C11-43											
	Socket	C55-43											
	Red Tee	C04-43	3/4" - 1 1/2"	According to pipe	-	BE	ASME B16.9	ASTM A403 Gr WP316/316L					
	Red Coupling	C08-43											
	Sweepolet	C57-43	1 1/2" - 20"										
	Weldolet	C12-43	2" - 20"										
	90 LR Elbow	C15-44	2" - 44"										
	45 LR Elbow	C16-44											
	90 SR Elbow	C17-44											
	Tee	C20-44											
	Cap	C22-44											
Cross	C24-44												
Conc. Red	C18-44												
Ecc. Red	C19-44	3" - 44"											
Red Tee	C21-44												
Nipple	Straight Nipple	N-S145	1/2" - 1 1/2"						According to pipe	-	PBE	ASTM A733	ASTM A312 TP316/316L
	Swage Conc Nipple	N-C144	3/4" - 1 1/2"								BLE x PSE	MSS SP-95	ASTM A403 Gr WP316/316L
		N-C444	2" - 4"										
	Swage Ecc Nipple	N-E144	3/4" - 1 1/2"	2" - 4"	PBE								
N-E444		2" - 4"	BLE x PSE										
Flanges	Socket Weld (SW)	F-150-JX	1/2" - 1 1/2"	According to pipe	Class 150	Raised Face	ASME B16.5	ASTM A182 Gr F316/316L					
	Welding Neck (WN)	F-150-KX	2" - 44"			-	-						
		F-350-4X	1/2" - 3"			ISO 6162-1							
	Blind	F-150-LX	1" - 24"			ASME B16.5							
			26" - 44"			ASME B16.47 A							
Hyd One-Piece Flange	F-350-3X	1/2" - 3"	max 350 bar	-	ISO 6162-1								
Gasket	Spiral-Wound	J-150-EH	1/2" - 44"	-	Class 150	Raised Face	ASME B16.20	AISI 316/graphite					
Stud & Nuts	Stud and Nuts	P-150-08	1/2" - 1 1/2"	-	-	-	ASME B1.1	A194 7L, Zn-Ni					
								A320 L7, Zn-Ni					
Paddles	Figure-8 Blank	R8-150-RS	1/2" - 14"	According to pipe	150	Raised Face ASME B16.5	ASME B16.48	Stainless Steel ASTM A240 316					
	Paddle Blank	RA-150-RS	16" - 44"										
	Paddle Spacer	RE-150-RS											



		OFFSHORE PRODUCTION FACILITIES ENGINEERING GUIDELINES	Doc: I-ET-3010.2Q-1200-200-P4X-001	Revision: Rev 0	Sheet 1 of 2
		OFFSHORE PRODUCTION FACILITIES ENGINEERING GUIDELINES			Issued by: SRGE/ESUP

Services (see notes): <b>HF</b> - Hot Fluid; <b>HWP</b> - Process Heating Water; <b>HUW</b> - Utility Heating Water; <b>S</b> - Steam; <b>SC</b> - Steam Condensate;	Material: <b>Carbon Steel</b>	Class: <b>150</b>	Standard: <b>B4</b>
---	----------------------------------	----------------------	------------------------

Pressure Rating (see notes)										
Temperature (°C)	0	38	50	100	150	200	250	300		
Max Pressure (barg)	19.6	19.6	19.2	17.7	15.8	13.8	12.1	10.2		

**Pipes and Fittings (see notes)**

Items	Code	Size	Wall	Class	Ends	Standard	Material					
Pipes	T-102	1/2" - 1 1/2"	XS	-	PE	ASME B36.10	API 5L Gr B PSL 1 SML					
		2" - 6"	STD		BE		API 5L Gr B PSL 1 (SML or WLD HFW or WLD SAW)					
		8" - 12"	S-20									
		14"	S-10				API 5L Gr B PSL 1 WLD (HFW or SAW)					
		16" - 18"										
		20"						0.281"				
24"	0.312"											
Fittings	90 Elbow	C01-02	-	3000	SW	ASME B16.11	ASTM A105					
	45 Elbow	C02-02										
	Tee	C03-02										
	Cross	C05-02										
	Coupling	C06-02										
	Cap	C11-02										
	Socketlet	C55-02										
	Red Tee	C04-02										
	Red Coupling	C08-02										
	Weldolet	C12-02										
	90 LR Elbow	C15-03						According to pipe	-	BE	ASME B16.9	ASTM A234 Gr WPB
	45 LR Elbow	C16-03										
	90 SR Elbow	C17-03										
	Tee	C20-03										
	Cap	C22-03										
	Cross	C24-03										
	Conc. Red	C18-03	3" - 24"									
	Ecc. Red	C19-03										
Red Tee	C21-03											
Nipple	Straight Nipple	N-S120	According to pipe	-	PBE	ASTM A733	API 5L Gr B PSL 1 seamless					
	Swage Conc Nipple	N-C103			3/4" - 1 1/2"	BLE x PSE	MSS SP-95	ASTM A234 Gr WPB				
		N-C403			2" - 4"							
	Swage Ecc Nipple	N-E103			3/4" - 1 1/2"	2" - 4"	PBE	-	-			
		N-E403			2" - 4"							
Flanges	Socket Weld (SW)	F-150-J2	According to pipe	Class 150	Raised Face	ASME B16.5	ASTM A105					
	Welding Neck (WN)	F-150-K2			2" - 24"	-	-					
	Blind	F-150-L2			1/2" - 24"	-	-					
Gasket	Spiral-Wound	J-150-EH	-	Class 150	Raised Face	ASME B16.20	AISI 316/graphite					
Stud & Nuts	Stud and Nuts	P-150-01	-	-	-	ASME B1.1	A194 Gr 2H					
						ASME B1.1	A193 B7					
Bolt	2 x Hex Bolt	H-150-01	According to pipe	-	-	ASME B1.1	ASTM A193 Gr B7					
Paddles	Figure-8 Blank	R8-150-RC	According to pipe	150	Raised Face ASME B16.5	ASME B16.48	Carbon Steel ASTM A516 GR60					
	Paddle Blank	RA-150-RC										
	Paddle Spacer	RE-150-RC										

### Valves (see notes)

Type	Size	CODE	Temp	Type	Size	CODE	Temp	Type	Size	CODE	Temp	Type	Size	CODE	Temp		
Check	½" - 1 ½"	VRE-800-1-C103	-29C to 400C	Ball	½" - 1 ½"	VES-802-1-C105	-29C to 210C	Gate	2" - 24"	VES-150-3-C162	0C to 210C	Gate	2" - 24"	VGA-150-2-C131	-29C to 400C		
Needle	½" - 1 ½"	VAG-3000-1-S201	-100C to 200C			VES-802-2-C105				VGA-150-3-C163				VGA-801-1-C101		VGL-150-1-C102	
		VAG-3000-1-S202				-100C to 400C											VES-802-3-C105
Butterfly	6" - 20"	VBO-150-2-C111	-29C to 150C		2" - 24"	VES-150-1-C160	0C to 210C		Gate	½" - 1 ½"	VGA-801-2-C101		-29C to 400C	Check	2" - 24"	VRE-150-1-C113	-29C to 400C
	24"	VBO-150-2-C113	-29C to 200C			VES-150-1-C162					VGA-150-1-C131					VRE-150-2-C113	
	6" - 20"	VBO-150-3-C161	-29C to 240C			VES-150-2-C160					VGA-150-1-C132						
	24"	VBO-150-3-C163	-29C to 240C	VES-150-2-C162													



### Branch (see notes)

0.5	TEE															
0.75	RTEE TEE															
1	RTEE RTEE TEE															
1.5	RTEE RTEE RTEE TEE															
2	SOC SOC SOC SOC TEE															
3	SOC SOC SOC SOC RTEE TEE															
4	SOC SOC SOC SOC RTEE RTEE TEE															
6	SOC SOC SOC SOC WOL RTEE RTEE TEE															
8	SOC SOC SOC SOC WOL WOL RTEE RTEE TEE															
10	SOC SOC SOC SOC WOL WOL WOL RTEE RTEE TEE															
12	SOC SOC SOC SOC WOL WOL WOL WOL RTEE RTEE RTEE TEE															
14	SOC SOC SOC SOC WOL WOL WOL WOL RTEE RTEE RTEE TEE															
16	SOC SOC SOC SOC WOL WOL WOL WOL WOL RTEE RTEE RTEE TEE															
18	SOC SOC SOC SOC WOL WOL WOL WOL WOL RTEE RTEE RTEE TEE															
20	SOC SOC SOC SOC WOL WOL WOL WOL WOL WOL RTEE RTEE RTEE TEE															
24	SOC SOC SOC SOC WOL WOL WOL WOL WOL WOL WOL RTEE RTEE RTEE TEE															
0.5	0.75	1	1.5	2	3	4	5	6	8	10	12	14	16	18	20	24

WOL - Weldolet  
 TEE - Tee  
 RTEE - Red Tee  
 HC - Half Coupling  
 SOC - Sockolet

### Notes

1	On the spec valve list, it may have valve codes which contain values of process data lower than spec limits. It shall be verified all valve process data (e.g.: pressure, temperature) in order to specify it according the design premisses.
2	See Annex A for valves requirements and general selection criteria.
4	See Annex C for instruments, drains and vents typical piping arrangement.
5	Flanges ≤ 1 1/2" may be used, if strictly necessary.
7	Welding and Welding Inspection activities shall follow the requirements of these documents: I-ET-3010.00-1200-955-P4X-001-Welding.
125	Materials listed in this spec shall meet the requirements described in the notes and annexes of this document and also the requirements of the specific data sheet in IOGP S-563 as applicable. In case of conflict of criteria Petrobras shall be consulted. It shall be highlighted that the IOGP requirements is not applicable for: inconel 625 coating, which shall follow I-ET-3010.00-1200-955-P4X-001; supplementary NACE requirement for carbon steel which shall follow Annex D; and coating for bolts and nuts shall follow spec note number 3.

 <b>PETROBRAS</b>		OFFSHORE PRODUCTION FACILITIES ENGINEERING GUIDELINES	Doc: I-ET-3010.2Q-1200-200-P4X-001	Revision: Rev 0	Sheet 1 of 2
		OFFSHORE PRODUCTION FACILITIES ENGINEERING GUIDELINES			Issued by: SRGE/ESUP

Services (see notes): F - Safety System and Flare; FG - Fuel Gas; G - Glycol; GL - Refrigerated Liquefied Petroleum Gases in Low Temperature; P - Process (non-corrosive hydrocarbon);	Material: Low Temp CS	Class: 150	Standard: B6
---	--------------------------	---------------	-----------------



Pressure Rating (see notes)											
Temperature (°C)	-46	0	38	50	100	150	200	240			
Max Pressure (barg)	19.6	19.6	19.6	19.2	17.7	15.8	13.8	12.4			

**Pipes and Fittings (see notes)**

Items	Code	Size	Wall	Class	Ends	Standard	Material		
Pipes	T-105	1/2" - 1 1/2"	S-160	-	PE	ASME B36.10	ASTM A333 Gr 6 SML		
		2" - 6"	STD		BE				
		8" - 12"	S-20						
		14"	S-10						
	T-106	16" - 30"	STD					ASTM A671 Gr CC60 Class 22 WLD	
		32" - 36"							
Fittings	90 Elbow	C01-04	1/2" - 1 1/2"	-	6000	SW	ASME B16.11	ASTM A350 Gr LF2 Cl 1	
	45 Elbow	C02-04							
	Tee	C03-04							
	Cross	C05-04							
	Coupling	C06-04							
	Cap	C11-04							
	Sockolet	C55-04							
	Red Tee	C04-04	3/4" - 1 1/2"	-	-	-	-	-	
	Red Coupling	C08-04							
	Weldolet	C12-04	2" - 16"	According to pipe	-	BE	ASME B16.9	ASTM A420 Gr WPL6	
	90 LR Elbow	C15-05							
	45 LR Elbow	C16-05							
	90 SR Elbow	C17-05							
	Tee	C20-05							
	Cap	C22-05							
Cross	C24-05								
Conc. Red	C18-05								
Ecc. Red	C19-05								
Red Tee	C21-05								
Nipple	Straight Nipple	N-S137	1/2" - 1 1/2"	According to pipe	-	PBE	ASTM A733	ASTM A333 Gr 6	
	Swage Conc Nipple	N-C105	3/4" - 1 1/2"			BLE x PSE	MSS SP-95	ASTM A420 Gr WPL6	
		N-C405	2" - 4"						
	Swage Ecc Nipple	N-E105	3/4" - 1 1/2"			2" - 4"	BLE x PSE	-	-
		N-E405	2" - 4"						
Flanges	Socket Weld (SW)	F-150-J3	1/2" - 1 1/2"	According to pipe	Class 150	Raised Face	ASME B16.5	ASTM A350 Gr LF2 Class 1	
	Welding Neck (WN)	F-150-K3	2" - 24"			ASME B16.47 A			
			26" - 36"			-			
Blind	F-150-L3	1/2" - 36"	-	Class 150	Raised Face	ASME B16.20	AISI 316/graphite		
Gasket	Spiral-Wound	J-150-EH	1/2" - 36"	-	-	-	ASME B1.1	A194 Gr 2H, Zn-Ni	
Stud & Nuts	Stud and Nuts	P-150-07	1/2" - 1 1/2"	-	-	-	ASME B1.1	A193 B7, Zn-Ni	
Bolt	2 x Hex Bolt	H-150-01	1/2" - 1 1/2"	According to pipe	-	-	ASME B1.1	ASTM A193 Gr B7	
Paddles	Figure-8 Blank	R8-150-RL	1/2" - 14"	According to pipe	150	Raised Face ASME B16.5	ASME B16.48	Low Temp. Carbon Steel ASTM A516.70 + S5	
	Paddle Blank	RA-150-RL	16" - 36"						
	Paddle Spacer	RE-150-RL							





 <b>PETROBRAS</b>		OFFSHORE PRODUCTION FACILITIES ENGINEERING GUIDELINES			Doc: I-ET-3010.2Q-1200-200-P4X-001	Revision: Rev 0	Sheet 1 of 2
		OFFSHORE PRODUCTION FACILITIES ENGINEERING GUIDELINES					Issued by: SRGE/ESUP

Services (see notes): <b>FL</b> - Foam Line; <b>FW</b> - Fire Water (Sea Water);	Material: <b>Copper-Nickel</b>	Class: <b>20 bar</b>	Standard: <b>B7</b>
---	-----------------------------------	-------------------------	------------------------

Pressure Rating (see notes)										
Temperature (°C)	0	38	50	75						
Max Pressure (barg)	19.6	19.6	19.2	18.4						

**Pipes and Fittings (see notes)**

Items	Code	Size	Wall	Class	Ends	Standard	Material	
Pipes	Pipe	T-202	½" - ¾"	2.0mm	-	PE	EEMUA 234	Cu-Ni 90/10 (UNS C7060X) SML
			1" - 2"	2.5mm				
			2 ½" - 3"	3.0mm				
			4"	3.5mm				
			6"	4.5mm		BE		
			8"	5.5mm				
			10"	7.0mm				
			12"	8.0mm				
			14"	9.0mm				
			16"	9.5mm				
			18"	11.0mm				
			20"	13.0mm				
			24"	15.0mm				
			28"	17.0mm				
32"	19.0mm							
36"	19.0mm							
Fittings	90 Elbow	C01-35	½" - 1 ½"	-	20 bar	EEMUA 234	Cu-Ni 90/10 (UNS C7060X)	
	45 Elbow	C02-35						
	Tee	C03-35						
	Coupling	C06-35						
	Plug	C09-35						
	Union	C10-35						
	Cap	C11-35						
	Connector	C37-35						
	Connector Union	C38-35	½" - 2"	-	-			
	Socketlet	C55-35						
	Red Coupling	C08-35	¾" - 1 ½"	-	20 bar	EEMUA 234		
	Bush	C23-35						
	Weldolet	C12-35	2" - 16"	According to pipe	-	BE		
	90 LR Elbow	C15-35						
	45 LR Elbow	C16-35						
	Tee	C20-35						
	Cap	C22-35						
	Conc. Red	C18-35	3" - 36"					
Ecc. Red	C19-35							
Red Tee	C21-35							
Stub End WN-L	C39-35							
Nipple	Connector Nipple	N-A335	¾" - 1 ½"				According to pipe	-
		N-A735						
		N-A835						
Flanges	Slip on (SO)	F-20-HM	½" - 1 ½"	According to pipe	20 bar	EEMUA 234	Cu-Ni 90/10 (UNS 7060X)	
	Blind	F-150-LY	1" - 24"		Class 150	Raised Face	ASME B16.5	ASTM A105 Thermal Spray coated (note 126)
	Backing Flange	F-20-Y2	28" - 36"		20 bar		ASME B16.47 A	
Gasket	Flat type	J-150-P4	½" - 36"	-	Class 150	Raised Face	ASME B16.21	Compressed sheet, fire-tested
							ASME B1.1	A193 Gr 2H, Zn-Ni
Stud & Nuts	Stud and Nuts	P-150-07	½" - 1 ½"	-	-	-	ASME B1.1	A193 B7, Zn-Ni
Bolt	2 x Hex Bolt	H-150-01	½" - 1 ½"	According to pipe	-	-	ASME B1.1	ASTM A193 Gr B7
	Figure-8 Blank	R8-150-RT	½" - 14"	According to pipe	150	Raised Face ASME B16.5	ASME B16.48	Carbon Steel ASTM A516 GR60 CurAl Thermal Spray coated (note 126)
Paddle Blank	RA-150-RT	16" - 36"						
Paddle Spacer	RE-150-RT							

### Valves (see notes)

Type	Size	CODE	Temp	Type	Size	CODE	Temp	Type	Size	CODE	Temp	Type	Size	CODE	Temp	
Check	½" - 1 ½"	VRE-200-1-U122	0C to 75C	Ball	1" - 1 ½"	VES-150-1-U300	0C to 90C	Diaphragm	1 ½" - 12"	VDI-300-2-U301	0C to 80C	Globe	2" - 18"	VGL-150-1-U301	0C to 90C	
	6" - 20"	VBO-150-2-U351	0C to 90C			VES-150-2-U300								VAN-150-1-U101		0C to 75C
Butterfly	24" - 36"	VBO-150-2-U353	-29C to 75C	Gate	1" - 24"	VES-150-2-U311	0C to 90C	Gate	½" - 1 ½"	VGA-200-1-U101	-29C to 75C	Check	2" - 36"	VRE-150-1-U311	0C to 90C	
	6" - 20"	VBO-150-3-U361				VGA-150-1-U331								VGL-150-1-U101		VRE-150-1-U312
	24" - 36"	VBO-150-3-U363				VGA-150-2-U331										



### Branch (see notes)

<b>RUN SIZE</b>	0.5	0.75	1	1.25	1.5	2	2.5	3	4	6	8	10	12	14	16	18	20	24	28	32	36
	TEE	RTEE	TEE	TEE	TEE	RTEE	TEE	TEE	TEE	WOL	WOL	WOL	WOL	WOL	WOL	WOL	WOL	WOL	WOL	WOL	WOL
	1	RTEE	RTEE	TEE	TEE	SOC	SOC	SOC	SOC	WOL	WOL	WOL	WOL	WOL	WOL	WOL	WOL	WOL	WOL	WOL	WOL
	1.5	RTEE	RTEE	RTEE	TEE	SOC	SOC	SOC	SOC	WOL	WOL	WOL	WOL	WOL	WOL	WOL	WOL	WOL	WOL	WOL	WOL
	2	SOC	SOC	SOC	SOC	RTEE	TEE	TEE	TEE	WOL	WOL	WOL	WOL	WOL	WOL	WOL	WOL	WOL	WOL	WOL	WOL
	2.5	SOC	SOC	SOC	SOC	SOC	RTEE	TEE	TEE	WOL	WOL	WOL	WOL	WOL	WOL	WOL	WOL	WOL	WOL	WOL	WOL
	3	SOC	SOC	SOC	SOC	SOC	RTEE	RTEE	TEE	WOL	WOL	WOL	WOL	WOL	WOL	WOL	WOL	WOL	WOL	WOL	WOL
	4	SOC	SOC	SOC	SOC	SOC	RTEE	RTEE	TEE	WOL	WOL	WOL	WOL	WOL	WOL	WOL	WOL	WOL	WOL	WOL	WOL
	6	SOC	SOC	SOC	SOC	SOC	WOL	WOL	WOL	WOL	WOL	WOL	WOL	WOL	WOL	WOL	WOL	WOL	WOL	WOL	WOL
	8	SOC	SOC	SOC	SOC	SOC	WOL	WOL	WOL	WOL	WOL	WOL	WOL	WOL	WOL	WOL	WOL	WOL	WOL	WOL	WOL
	10	SOC	SOC	SOC	SOC	SOC	WOL	WOL	WOL	WOL	WOL	WOL	WOL	WOL	WOL	WOL	WOL	WOL	WOL	WOL	WOL
	12	SOC	SOC	SOC	SOC	SOC	WOL	WOL	WOL	WOL	WOL	WOL	WOL	WOL	WOL	WOL	WOL	WOL	WOL	WOL	WOL
	14	SOC	SOC	SOC	SOC	SOC	WOL	WOL	WOL	WOL	WOL	WOL	WOL	WOL	WOL	WOL	WOL	WOL	WOL	WOL	WOL
	16	SOC	SOC	SOC	SOC	SOC	WOL	WOL	WOL	WOL	WOL	WOL	WOL	WOL	WOL	WOL	WOL	WOL	WOL	WOL	WOL
	18	SOC	SOC	SOC	SOC	SOC	WOL	WOL	WOL	WOL	WOL	WOL	WOL	WOL	WOL	WOL	WOL	WOL	WOL	WOL	WOL
	20	SOC	SOC	SOC	SOC	SOC	WOL	WOL	WOL	WOL	WOL	WOL	WOL	WOL	WOL	WOL	WOL	WOL	WOL	WOL	WOL
	24	SOC	SOC	SOC	SOC	SOC	WOL	WOL	WOL	WOL	WOL	WOL	WOL	WOL	WOL	WOL	WOL	WOL	WOL	WOL	WOL
	28	SOC	SOC	SOC	SOC	SOC	WOL	WOL	WOL	WOL	WOL	WOL	WOL	WOL	WOL	WOL	WOL	WOL	WOL	WOL	WOL
	32	SOC	SOC	SOC	SOC	SOC	WOL	WOL	WOL	WOL	WOL	WOL	WOL	WOL	WOL	WOL	WOL	WOL	WOL	WOL	WOL
	36	SOC	SOC	SOC	SOC	SOC	WOL	WOL	WOL	WOL	WOL	WOL	WOL	WOL	WOL	WOL	WOL	WOL	WOL	WOL	WOL
	0.5	0.75	1	1.25	1.5	2	2.5	3	4	6	8	10	12	14	16	18	20	24	28	32	36
	BRANCH SIZE																				

WOL - Weldolet  
 TEE - Tee  
 RTEE - Red Tee  
 HC - Half Coupling  
 SOC - Sockolet

### Notes

1	On the spec valve list, it may have valves codes which contain values of process data lower than spec limits. It shall be verified all valve process data (e.g.: pressure, temperature) in order to specify it according the design premisses.
2	See Annex A for valves requirements and general selection criteria.
3	Bolts,nuts and gaskets (only RTJ gaskets) must be Zn-Ni coated according to Annex B.
4	See Annex C for instruments, drains and vents typical piping arrangement.
6	See Annex E for Isolation gasket specifications.
7	Welding and Welding Inspection activities shall follow the requeriments of these documents: I-ET-3010.00-1200-955-P4X-001-Welding.
53	This spec must be used only for offshore facilities.
86	Pipes in this spec do not take account additional thickness for threads. Must be evaluated pipes thicker than these here specified if threaded pipe will be applied.
87	Piping, connections and flanges should be specified according EEMUA 234.
104	The backing flange and stub ends are part of the composite flange according EEMUA 234.
110	Epoxy coating for flanges shall be applied according to I-ET-3010.00-1200-956-P4X-002 - General Painting.
115	Gaskets shall not be used to assembly butterfly valves API 609 category A, unless required required by the valve manufacturer.
125	Materials listed in this spec shall meet the requirements described in the notes and annexes of this document and also the requirements of the specific data sheet in IOGP S-563 as applicable. In case of conflict of criteria Petrobras shall be consulted. It shall be highlighted that the IOGP requirements is not applicable for: inconel 625 coating, which shall follow I-ET-3010.00-1200-955-P4X-001; supplementary NACE requirement for carbon steel which shall follow Annex D; and coating for bolts and nuts shall follow spec note number 3.
126	Thermal spray application shall be according to the requirements of I-ET-3010.00-1200-956-P4X-003. Consumable specification: AWS C2.25m: W-CuAl-1 or ISO 14919: CuAl10.
143	Piping material shall be certified and approved by Classification Society for the intended service.Piping in FRP for open drain shall not be used in classified areas, except for overboard purposes.
152	SW connection may be used instead of capillary connection.
153	Backing flange in carbon steel shall be galvanized before painting.

 <b>PETROBRAS</b>		<b>OFFSHORE PRODUCTION FACILITIES ENGINEERING GUIDELINES</b>				Doc: I-ET-3010.2Q-1200-200-P4X-001	Revision: Rev 0	Sheet 1 of 2
		<b>OFFSHORE PRODUCTION FACILITIES ENGINEERING GUIDELINES</b>					Issued by: SRGE/ESUP	Code: ASME B31.3



Services (see notes): <b>AM</b> - Amine; <b>DA</b> - Open Drain; <b>DFC</b> - Closed Drain (Corrosive Hydrocarbon); <b>F</b> - Safety System and Flare; <b>PC</b> - Process (Corrosive Hydrocarbon);	Material: <b>Carbon Steel</b>	Class: <b>150</b>	Standard: <b>B9</b>
---	----------------------------------	----------------------	------------------------

Pressure Rating (see notes)										
Temperature (°C)	-29	0	38	50	100	150	200	240		
Max Pressure (barg)	19.6	19.6	19.6	19.2	17.7	15.8	13.8	12.4		

**Pipes and Fittings (see notes)**

Items	Code	Size	Wall	Class	Ends	Standard	Material							
<b>Pipes</b>	Pipe	T-102	1/2" - 1 1/2"	S-160	-	PE	API 5L Gr B PSL 1 SML							
			2"	XS		BE		ASME B36.10						
			3" - 6"	STD					API 5L Gr B PSL 1 (SML or WLD HFW or WLD SAW)					
			8" - 10"	S-20										
			12"	0.281"										
			14"	S-20										
			16" - 18"											
			20" - 24"	STD										
			26" - 28"											
			30" - 32"							0.406"	API 5L Gr B PSL 1 WLD (HFW or SAW)			
34"	0.438"													
36"	0.469"	API 5L Gr B PSL 1 WLD SAW												
<b>Fittings</b>	90 Elbow	C01-02	-	6000	SW	ASME B16.11	ASTM A105							
	45 Elbow	C02-02												
	Tee	C03-02												
	Cross	C05-02												
	Coupling	C06-02												
	Cap	C11-02												
	Socketlet	C55-02												
	Red Tee	C04-02												
	Red Coupling	C08-02												
	Weldolet	C12-02												
	90 LR Elbow	C15-03						According to pipe	-	BE	ASME B16.9	ASTM A234 Gr WPB		
	45 LR Elbow	C16-03												
	90 SR Elbow	C17-03												
	Tee	C20-03												
	Cap	C22-03												
	Cross	C24-03												
	Conc. Red	C18-03												
	Ecc. Red	C19-03												
Red Tee	C21-03													
2" - 36"	-													
3" - 36"														
<b>Nipple</b>		Straight Nipple	N-S120	1/2" - 1 1/2"	According to pipe	-	PBE						ASTM A733	API 5L Gr B PSL 1 seamless
		Swage Conc Nipple	N-C103	3/4" - 1 1/2"			BLE x PSE						MSS SP-95	ASTM A234 Gr WPB
			N-C403	2" - 4"										
		Swage Ecc Nipple	N-E103	3/4" - 1 1/2"			PBE							
			N-E403	2" - 4"									BLE x PSE	
<b>Flanges</b>		Socket Weld (SW)	F-150-J2	1/2" - 1 1/2"	According to pipe	Class 150	Raised Face						ASME B16.5	ASTM A105
		Welding Neck (WN)	F-150-K2	2" - 24"									ASME B16.47 A	
			F-150-L2	26" - 36"				-						
Blind		F-150-L2	1/2" - 36"	-										
<b>Gasket</b>		Spiral-Wound	J-150-EH	1/2" - 36"	-	Class 150	Raised Face	ASME B16.20	AISI 316/graphite					
<b>Stud &amp; Nuts</b>		Stud and Nuts	P-150-07	1/2" - 1 1/2"	-	-	-	ASME B1.1	A194 Gr 2H, Zn-Ni					
								ASME B1.1	A193 B7, Zn-Ni					
								ASME B1.1	ASTM A193 Gr B7					
<b>Bolt</b>		2 x Hex Bolt	H-150-01	1/2" - 1 1/2"	According to pipe	-	-	ASME B1.1	ASTM A193 Gr B7					
		Figure-8 Blank	R8-150-RC	1/2" - 14"	According to pipe	150	Raised Face ASME B16.5	ASME B16.48	Carbon Steel ASTM A516 GR60					
		Paddle Blank	RA-150-RC	16" - 36"										
Paddle Spacer	RE-150-RC													



		OFFSHORE PRODUCTION FACILITIES ENGINEERING GUIDELINES	Doc: I-ET-3010.2Q-1200-200-P4X-001	Revision: Rev 0	Sheet 1 of 2
		OFFSHORE PRODUCTION FACILITIES ENGINEERING GUIDELINES			Issued by: SRGE/ESUP



Services (see notes): <b>AM</b> - Amine; <b>BG</b> - Inert Gas; <b>CHW</b> - Chilled Water; <b>CI</b> - Chemical Injection (non-corrosive); <b>D</b> - Diesel; <b>DF</b> - Closed Drain (Non-Corrosive hydrocarbon); <b>F</b> - Safety System and Flare; <b>FG</b> - Fuel Gas; <b>FL</b> - Foam Line; <b>G</b> - Glycol; <b>IW</b> - De-Aerated Sea Water Injection; <b>LO</b> - Lubricating Oil; <b>P</b> - Process (non-corrosive hydrocarbon); <b>RF</b> - Refrigerant Fluid; <b>SA</b> - Service Compressed Air (utility Air); <b>SN</b> - Startup Nitrogen; <b>W</b> - Industrial water;	Material: Carbon Steel	Class: 150	Standard: B10
--	---------------------------	---------------	------------------

Pressure Rating (see notes)										
Temperature (°C)	-29	0	38	50	100	150	200			
Max Pressure (barg)	19.6	19.6	19.6	19.2	17.7	15.8	13.8			

**Pipes and Fittings (see notes)**

Items	Code	Size	Wall	Class	Ends	Standard	Material						
Pipes	Pipe	T-102	1/2" - 1 1/2"	S-160	-	PE	ASME B36.10	API 5L Gr B PSL 1 SML					
			2"	STD		BE		API 5L Gr B PSL 1 (SML or WLD HFW or WLD SAW)					
			3" - 6"	S-20									
			8" - 12"	S-10									
			14"	0.281"					API 5L Gr B PSL 1 WLD (HFW or SAW)				
			16" - 18"	0.312"									
			20"	S-10									
			24"	0.344"									
			26" - 28"	STD						API 5L Gr B PSL 1 WLD SAW			
			30" - 32"	0.406"									
			34"	0.438"									
			36"	0.469"									
38"													
40"													
42"													
44"													
Fittings	90 Elbow	C01-02	-	6000	SW	ASME B16.11	ASTM A105						
	45 Elbow	C02-02											
	Tee	C03-02											
	Cross	C05-02											
	Coupling	C06-02											
	Cap	C11-02											
	Socket	C55-02											
	Red Tee	C04-02											
	Red Coupling	C08-02											
	Weldolet	C12-02						According to pipe	-	BE	ASME B16.9	ASTM A234 Gr WPB	
	90 LR Elbow	C15-03											
	45 LR Elbow	C16-03											
	90 SR Elbow	C17-03											
	Tee	C20-03											
	Cap	C22-03											
Cross	C24-03												
Conc. Red	C18-03												
Ecc. Red	C19-03												
Red Tee	C21-03												
Nipple	Straight Nipple	N-S120	1/2" - 1 1/2"	According to pipe	-	PBE	ASTM A733						API 5L Gr B PSL 1 seamless
	Swage Conc Nipple	N-C103	3/4" - 1 1/2"			BLE x PSE	MSS SP-95						ASTM A234 Gr WPB
		N-C403	2" - 4"										
	Swage Ecc Nipple	N-E103	3/4" - 1 1/2"			2" - 4"	BLE x PSE						
		N-E403	2" - 4"										
Flanges	Socket Weld (SW)	F-150-J2	1/2" - 1 1/2"	According to pipe	Class 150	Raised Face	ASME B16.5	ASTM A105					
	Welding Neck (WN)	F-150-K2	2" - 24"			ASME B16.47 A							
			26" - 44"			-							
Blind	F-150-L2	1/2" - 44"											
Gasket	Spiral-Wound	J-150-EH	1/2" - 44"	-	Class 150	Raised Face	ASME B16.20	AISI 316/graphite					
Stud & Nuts	Stud and Nuts	P-150-07	1/2" - 1 1/2"	-	-	-	ASME B1.1	A194 Gr 2H, Zn-Ni					
								A193 B7, Zn-Ni					
Bolt	2 x Hex Bolt	H-150-01	1/2" - 1 1/2"	According to pipe	-	-	ASME B1.1	ASTM A193 Gr B7					
Paddles	Figure-8 Blank	R8-150-RC	1/2" - 14"	According to pipe	150	Raised Face ASME B16.5	ASME B16.48	Carbon Steel ASTM A516 GR60					
	Paddle Blank	RA-150-RC	16" - 44"										
	Paddle Spacer	RE-150-RC											



		OFFSHORE PRODUCTION FACILITIES ENGINEERING GUIDELINES	Doc: I-ET-3010.2Q-1200-200-P4X-001	Revision: Rev 0	Sheet 1 of 2
		OFFSHORE PRODUCTION FACILITIES ENGINEERING GUIDELINES			Issued by: SRGE/ESUP



Services (see notes): <b>ADW</b> - Aerated Dilution Water; <b>PC</b> - Process (Corrosive Hydrocarbon); <b>PCW</b> - Produced water;	Material: <b>Organic Coat CS</b>	Class: <b>150</b>	Standard: <b>B11</b>
---	-------------------------------------	----------------------	-------------------------

Pressure Rating (see notes)										
Temperature (°C)	0	38	50	100	150					
Max Pressure (barg)	19.6	19.6	19.2	17.7	15.8					

Pipes and Fittings (see notes)										
Items	Code	Size	Wall	Class	Ends	Standard	Material			
Pipes	Pipe	T-102	3" - 6"	STD	-	BE	ASME B36.10	API 5L Gr B PSL 1 (SML or WLD HFW or WLD SAW)		
			8" - 12"	S-20						
			14"	S-10						
			16" - 24"							
			26" - 28"				API 5L Gr B PSL 1 WLD (HFW or SAW)			
Fittings	Weldolet	C12-02	3" - 12"	According to pipe	-	BE	MSS SP-97	ASTM A105		
	90 LR Elbow	C15-03	3" - 28"				ASME B16.9	ASTM A234 Gr WPB		
	45 LR Elbow	C16-03								
	90 SR Elbow	C17-03								
	Tee	C20-03								
	Cap	C22-03								
	Cross	C24-03								
	Conc. Red	C18-03								
	Ecc. Red	C19-03	4" - 28"							
Red Tee	C21-03									
Flanges	Welding Neck (WN)	F-150-K2	3" - 24"	According to pipe	Class 150	Raised Face	ASME B16.5	ASTM A105		
	Blind	F-150-L2	26" - 28"				ASME B16.47 A			
Gasket	Flat type	J-150-PC	3" - 28"	-	Class 150	Raised Face	ASME B16.21	Multidirectional Expanded PTFE		
Stud & Nuts	Stud and Nuts	P-150-07	1/2" - 1 1/4"	-	-	-	ASME B1.1	A194 Gr 2H, Zn-Ni		
Bolt	2 x Hex Bolt	H-150-01	1/2" - 1 1/2"	According to pipe	-	-	ASME B1.1	ASTM A193 Gr B7		
Paddles	Figure-8 Blank	R8-150-RP	3" - 14"	According to pipe	150	Raised Face ASME B16.5	ASME B16.48	Carbon Steel ASTM A516 GR60 epoxy coated		
	Paddle Blank	RA-150-RP	16" - 28"							
	Paddle Spacer	RE-150-RP								





		OFFSHORE PRODUCTION FACILITIES ENGINEERING GUIDELINES	Doc: I-ET-3010.2Q-1200-200-P4X-001	Revision: Rev 0	Sheet 1 of 2
		OFFSHORE PRODUCTION FACILITIES ENGINEERING GUIDELINES			Issued by: SRGE/ESUP



Services (see notes): F - Safety System and Flare; PC - Process (Corrosive Hydrocarbon); PCW - Produced water;	Material: Super Duplex	Class: 150	Standard: B12
---	---------------------------	---------------	------------------

Pressure Rating (see notes)										
Temperature (°C)	0	38	50	100	120	140				
Max Pressure (barg)	20	20	19.5	17.7	16.9	16.1				

**Pipes and Fittings (see notes)**

Items		Code	Size	Wall	Class	Ends	Standard	Material	
Pipes	Pipe	T-303	1/2" - 1 1/2" 2" - 8"	S-40S	-	PE	ASME B36.10/B36.19	ASTM A790 (UNS S32760) SML	
		T-304	10" - 24" 26" - 36"			BE		ASTM A928 (UNS S32760 Cl 1 or 3) WLD	
				0.375"					
Fittings	90 Elbow	C01-30	1/2" - 1 1/2"	-	3000	SW	ASME B16.11	ASTM A182 Gr F55 (UNS S32760)	
	45 Elbow	C02-30							
	Tee	C03-30							
	Cross	C05-30							
	Coupling	C06-30							
	Cap	C11-30							
	Socket	C55-30							
	Red Tee	C04-30							
	Red Coupling	C08-30	3/4" - 1 1/2"	-	3000	SW	ASME B16.11	ASTM A182 Gr F55 (UNS S32760)	
	Weldolet	C12-30							
	90 LR Elbow	C15-32	2" - 36"	According to pipe	-	BE	ASME B16.9	ASTM A815 (UNS S32760)	
	45 LR Elbow	C16-32							
	90 SR Elbow	C17-32							
	Tee	C20-32							
	Cap	C22-32							
	Cross	C24-32							
	Conc. Red	C18-32							
	Ecc. Red	C19-32							
Red Tee	C21-32	3" - 36"	According to pipe	-	BE	ASME B16.9	ASTM A815 (UNS S32760)		
Nipple	Straight Nipple	N-S131	1/2" - 1 1/2"	According to pipe	-	PBE	ASTM A733	ASTM A790 (UNS S32760)	
	Swage Conc Nipple	N-C132	3/4" - 1 1/2"			BLE x PSE	MSS SP-95	ASTM A815 (UNS S32760)	
		N-C432	2" - 4"						
	Swage Ecc Nipple	N-E132	3/4" - 1 1/2"			2" - 4"	PBE	MSS SP-95	ASTM A815 (UNS S32760)
		N-E432	2" - 4"						
Flanges	Socket Weld (SW)	F-150-JH	1/2" - 1 1/2"	According to pipe	Class 150	Raised Face	ASME B16.5	ASTM A182 Gr F55	
	Welding Neck (WN)	F-150-KH	2" - 24"				ASME B16.47 A		
			26" - 36"				-		
Blind	F-150-LH	1/2" - 36"	-	Class 150	Raised Face	ASME B16.20	Duplex/graphite		
Gasket	Spiral-Wound	J-150-EL	1/2" - 36"	-	Class 150	Raised Face	ASME B16.20	A194 7L, Zn-Ni	
Stud & Nuts	Stud and Nuts	P-150-08	1/2" - 1 1/2"	-	-	-	ASME B1.1	A320 L7, Zn-Ni	
Paddles	Figure-8 Blank	R8-150-RX	1/2" - 14"	According to pipe	150	Raised Face ASME B16.5	ASME B16.48	Superduplex ASTM A240 UNS32760	
	Paddle Blank	RA-150-RX							
	Paddle Spacer	RE-150-RX							





		OFFSHORE PRODUCTION FACILITIES ENGINEERING GUIDELINES	Doc: I-ET-3010.2Q-1200-200-P4X-001	Revision: Rev 0	Sheet 1 of 2
		OFFSHORE PRODUCTION FACILITIES ENGINEERING GUIDELINES			Issued by: SRGE/ESUP

Services (see notes): <b>CN</b> - Sodium Hypochlorite; <b>DA</b> - Open Drain; <b>W</b> - De-Aerated Sea Water Injection; <b>MC</b> - Aerated Sea Water Injection; <b>SW</b> - Aerated Sea Water;	Material: <b>Organic Coat CS</b>	Class: <b>150</b>	Standard: <b>B14</b>
--	-------------------------------------	----------------------	-------------------------

Pressure Rating (see notes)										
Temperature (°C)	0	38	50	70	80					
Max Pressure (barg)	19.6	19.6	19.2	18.6	18.4					

Pipes and Fittings (see notes)										
Items	Code	Size	Wall	Class	Ends	Standard	Material			
Pipes	Pipe	T-102	3" - 6"	STD	-	BE	ASME B36.10	API 5L Gr B PSL 1 (SML or WLD HFW or WLD SAW)		
			8" - 12"	S-20						
			14"	S-10						
			16" - 24"							
			26" - 30"							
32" - 44"	STD				API 5L Gr B PSL 1 WLD SAW					
Fittings	Weldolet	C12-02	3" - 20"	According to pipe	-	BE	MSS SP-97	ASTM A105		
	90 LR Elbow	C15-03	3" - 44"				ASME B16.9	ASTM A234 Gr WPB		
	45 LR Elbow	C16-03								
	90 SR Elbow	C17-03								
	Tee	C20-03								
	Cap	C22-03								
	Cross	C24-03								
	Conc. Red	C18-03							4" - 42"	
Ecc. Red	C19-03									
Red Tee	C21-03									
Flanges	Welding Neck (WN)	F-150-D2	3" - 24"	According to pipe	Class 150	Flat Face	ASME B16.5	ASTM A105		
	Blind	F-150-E2	26" - 44"				ASME B16.47 A			
			3" - 44"				-			
Gasket	Flat type	J-150-CC	3" - 44"	-	Class 150	Flat Face	ASME B16.21	Multidirectional Expanded PTFE		
Stud & Nuts	Stud and Nuts	P-150-07	1" - 1 1/2"	-	-	-	ASME B1.1	A194 Gr 2H, Zn-Ni		
			3" - 14"	-	-	-	ASME B1.1	A193 B7, Zn-Ni		
Bolt	2 x Hex Bolt	H-150-01	1/2" - 1 1/2"	According to pipe	-	-	ASME B1.1	ASTM A193 Gr B7		
Paddles	Figure-8 Blank	R8-150-FP	3" - 14"	According to pipe	150	Flat Face ASME B16.5	ASME B16.48	Carbon Steel ASTM A516 GR60 epoxy coated		
	Paddle Blank	RA-150-FP	16" - 44"							
	Paddle Spacer	RE-150-FP								



		OFFSHORE PRODUCTION FACILITIES ENGINEERING GUIDELINES	Doc: I-ET-3010.2Q-1200-200-P4X-001	Revision: Rev 0	Sheet 1 of 2
		OFFSHORE PRODUCTION FACILITIES ENGINEERING GUIDELINES			Issued by: SRGE/ESUP

Services (see notes): <b>AM</b> - Amine; <b>F</b> - Safety System and Flare; <b>PC</b> - Process (Corrosive Hydrocarbon); <b>PCW</b> - Produced water;	Material: <b>Duplex</b>	Class: <b>150</b>	Standard: <b>B16</b>
---	----------------------------	----------------------	-------------------------

Pressure Rating (see notes)										
Temperature (°C)	-46	0	38	50	100	130				
Max Pressure (barg)	20	20	20	19.5	17.7	16.5				

**Pipes and Fittings (see notes)**

Items		Code	Size	Wall	Class	Ends	Standard	Material	
Pipes	Pipe	T-301	1/2" - 1 1/2" 2" - 8"	S-40S	-	PE	ASME B36.10/B36.19	ASTM A790 (UNS S31803) SML	
		T-302	10" - 24" 26" - 40"			BE		ASTM A928 (UNS S31803 Cl 1 or 3) WLD	
				0.375"					
Fittings	90 Elbow	C01-27	1/2" - 1 1/2"	-	3000	SW	ASME B16.11	ASTM A182 Gr F51 (UNS S31803)	
	45 Elbow	C02-27							
	Tee	C03-27							
	Cross	C05-27							
	Coupling	C06-27							
	Cap	C11-27							
	Socket	C55-27							
	Red Tee	C04-27	3/4" - 1 1/2"	-	3000	SW	ASME B16.11	ASTM A182 Gr F51 (UNS S31803)	
	Red Coupling	C08-27							
	Weldolet	C12-27							
	90 LR Elbow	C15-29	2" - 40"	According to pipe	-	BE	ASME B16.9	ASTM A815 (UNS S31803)	
	45 LR Elbow	C16-29							
	90 SR Elbow	C17-29							
	Tee	C20-29							
	Cap	C22-29							
	Cross	C24-29							
	Conc. Red	C18-29							
Ecc. Red	C19-29	3" - 40"	According to pipe	-	BE	ASME B16.9	ASTM A815 (UNS S31803)		
Red Tee	C21-29								
Nipple	Straight Nipple	N-S128	1/2" - 1 1/2"	According to pipe	-	PBE	ASTM A733	ASTM A790 (UNS S31803)	
	Swage Conc Nipple	N-C129	3/4" - 1 1/2"			BLE x PSE	MSS SP-95	ASTM A815 (UNS S31803)	
		N-C429	2" - 4"						
	Swage Ecc Nipple	N-E129	3/4" - 1 1/2"			2" - 4"	BLE x PSE	MSS SP-95	ASTM A815 (UNS S31803)
		N-E429	2" - 4"						
Flanges	Socket Weld (SW)	F-150-JG	1/2" - 1 1/2"	According to pipe	Class 150	Raised Face	ASME B16.5	ASTM A182 Gr F51	
	Welding Neck (WN)	F-150-KG	2" - 40"			-			
	Blind	F-150-LG	1/2" - 40"			-			
Gasket	Spiral-Wound	J-150-EL	1/2" - 40"	-	Class 150	Raised Face	ASME B16.20	Duplex/graphite	
Stud & Nuts	Stud and Nuts	P-150-07	1/2" - 1 1/2"	-	-	-	ASME B1.1	A194 Gr 2H, Zn-Ni	
								A193 B7, Zn-Ni	
Bolt	2 x Hex Bolt	H-150-01	1/2" - 1 1/2"	According to pipe	-	-	ASME B1.1	ASTM A193 Gr B7	
Paddles	Figure-8 Blank	R8-150-RD	1/2" - 14"	According to pipe	150	Raised Face ASME B16.5	ASME B16.48	Duplex Stainless Steel ASTM A240 UNS31803	
	Paddle Blank	RA-150-RD							
	Paddle Spacer	RE-150-RD							

### Valves (see notes)

Type	Size	CODE	Temp	Type	Size	CODE	Temp	Type	Size	CODE	Temp	Type	Size	CODE	Temp		
Check	1/2" - 1 1/2"	VRE-800-1-D202	-46C to 150C	Ball	1/2" - 1 1/2"	VES-801-3-D205	-46C to 150C	Ball	2" - 28"	VES-150-3-D21G	-30C to 150C	Double Ball	1/2" - 2"	VDE-150-2-D203	-46C to 150C		
		VRE-800-2-D202				VES-801-3-D2F5				VES-150-3-D226				VDE-150-2-D204			
Needle	1/2" - 1 1/2"	VAG-3000-1-D202	-46C to 150C		2" - 36"	2" - 36"	VES-150-1-D210		-30C to 150C	2" - 28"	VES-150-3-D23G		-46C to 150C	2" - 36"	1" - 2"	VDE-150-2-D2F1	-30C to 150C
		VAG-3000-1-D2F2					VES-150-1-D220									VES-150-3-D227	
Butterfly	6" - 20"	VBO-150-2-D211	-46C to 150C		2" - 28"	2" - 28"	VES-150-1-D230		-46C to 150C	2" - 36"	VES-150-3-D252		-30C to 150C	2" - 36"	1/2" - 1 1/2"	VGA-801-1-D201	-50C to 150C
	24" - 40"	VBO-150-2-D213	-46C to 200C				VES-150-2-D210		VES-150-3-D237							VDE-150-2-D2F3	
	6" - 20"	VBO-150-3-D261	-46C to 150C				VES-150-2-D216		VES-150-3-D236							VDE-150-2-D2F4	
	24" - 40"	VBO-150-3-D263	-46C to 150C				VES-150-2-D21F		VES-150-3-D252							VDE-150-2-D2F4	
Ball	1/2" - 1 1/2"	VES-801-1-D201	-30C to 150C		2" - 36"	2" - 36"	VES-150-2-D220		0C to 150C	2" - 28"	VES-150-3-D262		0C to 150C	2" - 18"	2" - 36"	VGA-150-1-D231	-50C to 150C
		VES-801-1-D202	-46C to 150C				VES-150-2-D226		VES-150-3-D263							VGL-150-1-D201	
		VES-801-1-D205	-30C to 150C				VES-150-2-D230		VES-150-3-D272							VGL-150-2-D201	
		VES-801-2-D201	-30C to 150C				VES-150-2-D236		VES-150-3-D273							VGL-150-2-D2F1	
		VES-801-2-D202	-46C to 150C	VES-150-2-D23F			VES-150-3-D27G	VRE-150-1-D211									
		VES-801-2-D205	-46C to 150C	VES-150-2-D23G			VDE-150-2-D201	VRE-150-2-D212									
		VES-801-2-D2F1	-30C to 150C	VES-150-3-D216			VDE-150-2-D202	VRE-150-2-D215									
		VES-801-2-D2F2	-46C to 150C	VES-150-3-D217				VRE-150-2-D235									
		VES-801-2-D2F5	-46C to 150C														



### Branch (see notes)

Run Size	Branch Size	Connection
0.5	0.75	TEE
0.75	1	RTEE
1	1.5	RTEE
1.5	2	RTEE
2	3	SOC
3	4	SOC
4	6	SOC
6	8	SOC
8	10	SOC
10	12	SOC
12	14	SOC
14	16	SOC
16	18	SOC
18	20	SOC
20	24	SOC
24	28	SOC
28	30	SOC
30	32	SOC
32	34	SOC
34	36	SOC
36	38	SOC
38	40	SOC
40	42	SOC
42	44	SOC
44	46	SOC
46	48	SOC
48	50	SOC
50	52	SOC
52	54	SOC
54	56	SOC
56	58	SOC
58	60	SOC
60	62	SOC
62	64	SOC
64	66	SOC
66	68	SOC
68	70	SOC
70	72	SOC
72	74	SOC
74	76	SOC
76	78	SOC
78	80	SOC
80	82	SOC
82	84	SOC
84	86	SOC
86	88	SOC
88	90	SOC
90	92	SOC
92	94	SOC
94	96	SOC
96	98	SOC
98	100	SOC

WOL - Weldolet  
TEE - Tee  
RTEE - Red Tee  
HC - Half Coupling  
SOC - Sockolet

### Notes

1	On the spec valve list, it may have valves codes which contain values of process data lower than spec limits. It shall be verified all valve process data (e.g.: pressure, temperature) in order to specify it according the design premisses.
2	See Annex A for valves requirements and general selection criteria.
3	Bolts,nuts and gaskets (only RTJ gaskets) must be Zn-Ni coated according to Annex B.
4	See Annex C for instruments, drains and vents typical piping arrangement.
5	Flanges ≤ 1 1/2" may be used, if strictly necessary.
6	See Annex E for isolation gasket specifications.
7	Welding and Welding Inspection activities shall follow the requeriments of these documents: I-ET-3010.00-1200-955-P4X-001-Welding.
8	All valves, pipes and components specified for hydrogen sulfide service shall be in accordance with ISO 15156 requirements. ASTM A 193 B7 / ASTM A 320 L7 studs with ASME B 16.5, ASME B 16.47 or API 6A flanges are acceptable for sour service fluids.
26	See Annex A for valve casting qualification requirements.
29	Duplex stainless steel external coating shall be applied for the temperature limits according to I-ET-3010.00-1200-956-P4X-002 - General Painting.
54	This spec for PC service should only be used when recommended in annex D.
57	All standardized pipe wall thickness herein listed are calculated considering only internal pressure. Other loads resulting of the piping analysis (supporting, flexibility, fatigue) may increase minimum required thickness.
60	This spec for Amine service is applicable for piping upstream the Amine Regeneration unit.
120	Wafer valves shall not be used with flammable or combustible services, according to NFPA definition.
122	Inspection of pipe and piping components shall follow ASTM A923 requirements.
125	Materials listed in this spec shall meet the requirements described in the notes and annexes of this document and also the requirements of the specific data sheet in IOGP S-563 as applicable. In case of conflict of criteria Petrobras shall be consulted. It shall be highlighted that the IOGP requirements is not applicable for: inconel 625 coating, which shall follow I-ET-3010.00-1200-955-P4X-001; supplementary NACE requirement for carbon steel which shall follow Annex D; and coating for bolts and nuts shall follow spec note number 3.

		OFFSHORE PRODUCTION FACILITIES ENGINEERING GUIDELINES	Doc: I-ET-3010.2Q-1200-200-P4X-001	Revision: Rev 0	Sheet 1 of 2
		OFFSHORE PRODUCTION FACILITIES ENGINEERING GUIDELINES			Issued by: SRGE/ESUP



Services (see notes): DA - Open Drain; HWU - Utility Heating Water; IW - De-Aerated Sea Water Injection; MC - Aerated Sea Water Injection; FWH - Hot Fresh Water; SW - Aerated Sea Water; W - Industrial water;	Material: FRP	Class: 10 bar	Standard: B22
--	------------------	------------------	------------------

Pressure Rating (see notes)											
Temperature (°C)	15	90									
Max Pressure (barg)	10	10									

Pipes and Fittings (see notes)												
Items		Code	Size	Wall	Class	Ends	Standard	Material				
Pipes	Pipe	T-404	1" - 36"	acc. manufact.	-	Bell-Spigot	ISO 14692	FRP - Bisphenol A Epoxy resins reinforced with fiberglass type E or E-CR. Design pressure 10 bar@90°C. SML				
			38"			Butt-Strap						
			40" - 48"			Bell-Spigot						
						Butt-Strap						
						Butt-Strap						
Fittings	Plug	C09-36	1" - 1 1/2"	-	250	THD	ASME B16.15	ASTM B62 (UNS C83600)				
	Thd Saddle	C52-52	1" - 6"	-	-	-	ISO 14692	FRP - Bisphenol A Epoxy resins reinforced with fiberglass type E or E-CR. Design pressure 10bar@90°C				
	Flg Saddle	C51-52										
	Tee	C20-52	1" - 40"	According to pipe	10 bar	Butt-Strap						
	90 LR Elbow	C15-52	1" - 44"			BellSpigot						
						Butt-Strap						
	45 LR Elbow	C16-52				BellSpigot						
						Butt-Strap						
	FRP Ecc. Red.	C62-52		2" - 40"		-						Butt-Strap
	Red Tee	C63-52	BellSpigot									
FRP Conc. Red.	C61-52	2" - 48"	BellSpigot									
Flanges	Blind	F-10-ET	1" - 40"	According to pipe		10 bar	Flat Face	ASTM D4024 - Drilling acc. B16.5/B16.47 CL150	FRP - Bisphenol A Epoxy resins reinforced with fiberglass type E or E-CR. Suitable for 90°C.			
	Integral Flange	F-10-1T										
Gasket	Flat type	J-150-C3	1" - 40"	-	Class 150	Flat Face	ASME B16.21	Neoprene				
Stud & Nuts	Stud and Nuts	P-150-07	1/2" - 1 1/2"	-	-	-	ASME B1.1	A194 Gr 2H, Zn-Ni				
Bolt	2 x Hex Bolt	H-150-01	1/2" - 1 1/2"	According to pipe	-	-	ASME B1.1	ASTM A193 Gr B7				
	Figure-8 Blank	R8-150-FP	1" - 14"									
Paddles	Paddle Blank	RA-150-FP	16" - 40"	According to pipe	150	Flat Face ASME B16.5	ASME B16.48	Carbon Steel ASTM A516 GR60 epoxy coated				
	Paddle Spacer	RE-150-FP										





		OFFSHORE PRODUCTION FACILITIES ENGINEERING GUIDELINES	Doc: I-ET-3010.2Q-1200-200-P4X-001	Revision: Rev 0	Sheet 1 of 2
		OFFSHORE PRODUCTION FACILITIES ENGINEERING GUIDELINES			Issued by: SRGE/ESUP

Services (see notes): ADW - Aerated Dilution Water; DA - Open Drain; HWU - Utility Heating Water; IW - De-Aerated Sea Water Injection; IWC - Aerated Sea Water Injection; PMW - Hot Fresh Water; SW - Aerated Sea Water; W - Industrial water;	Material: FRP	Class: 16 bar	Standard: B23
---	------------------	------------------	------------------

Pressure Rating (see notes)										
Temperature (°C)	15	90								
Max Pressure (barg)	16	16								

**Pipes and Fittings (see notes)**

Items	Code	Size	Wall	Class	Ends	Standard	Material			
Pipes	T-406	1" - 48"	acc. manufact.	-	Bell-Spigot	ISO 14692	FRP - Bisphenol A Epoxy resins reinforced with fiberglass type E or E-CR. Design pressure 16 bar@90°C. SML			
		1" - 56"			Butt-Strap					
		60"								
		64"								
Fittings	Plug	C09-36	-	250	THD	ASME B16.15	ASTM B62 (UNS C83600)			
	Thd Saddle	C52-54		1" - 1 1/2"	-	-	ISO 14692	FRP - Bisphenol A Epoxy resins reinforced with fiberglass type E or E-CR. Design pressure 16bar@90°C		
	Flg Saddle	C51-54		1" - 6"	-	-				
	Coupling	C06-54	1" - 48"	According to pipe	16 bar	BellSpigot				
	90 LR Elbow	C15-54				Butt-Strap				
	45 LR Elbow	C16-54				BellSpigot				
	Tee	C20-54				Butt-Strap				
	FRP Stub End	C64-54				BellSpigot				
Flanges	Blind	F-16-LT	According to pipe	16 bar	Raised Face	ASTM D4024 - Drilling acc. B16.5/B16.47 CL150	FRP - Bisphenol A Epoxy resins reinforced with fiberglass type E or E-CR. Suitable for 90°C.			
	Backing Flange	F-16-YV				Drilling acc. B16.5/B16.47 CL150	ASTM A105 Epoxy coated			
Gasket	Flat type	J-150-P3	-	Class 150	Raised Face	ASME B16.21	Neoprene			
Stud & Nuts	Stud and Nuts	P-150-07	-	-	-	ASME B1.1	A194 Gr 2H, Zn-Ni			
							A193 B7, Zn-Ni			
Bolt	2 x Hex Bolt	H-150-01	1/2" - 1 1/2"	According to pipe	-	ASME B1.1	ASTM A193 Gr B7			
Paddles	Figure-8 Blank	R8-150-RP	1" - 14"	According to pipe	150	Raised Face ASME B16.5	ASME B16.48			
	Paddle Blank	RA-150-RP	16" - 64"							
	Paddle Spacer	RE-150-RP								

### Valves (see notes)



Type	Size	CODE	Temp	Type	Size	CODE	Temp	Type	Size	CODE	Temp	Type	Size	CODE	Temp	
Check	1" - 1 1/2"	VRE-150-1-U305	0C to 90C	Butterfly	24" - 48"	VBO-150-2-U353	0C to 90C	Ball	2" - 4"	VES-150-1-U350	0C to 90C	Check	2" - 48"	VRE-150-1-U312	0C to 90C	
		VRE-150-2-D305	-46C to 150C			VBO-150-3-U361	-29C to 75C			VES-150-2-U310				VRE-150-1-U314		
Butterfly	6" - 20"	VBO-250-1-U291	0C to 75C	Ball	24" - 32"	VBO-150-3-U363	0C to 90C	Gate	1" - 12"	VGA-150-1-U332	0C to 90C	Ball	4" - 40"	VRE-150-2-U335	10C to 70C	
	24" - 46"	VBO-250-1-U293			1" - 1 1/2"	VES-150-1-U300				2" - 24"				VGL-150-1-U302		4" - 6"
	6" - 20"	VBO-150-2-U311	2" - 24"		VES-150-1-U310	1" - 1 1/2"				VGL-150-1-U303				2" - 3"		VES-250-1-U403
	24" - 48"	VBO-150-2-U313	2" - 4"		VES-150-1-U316					VGL-150-2-U302				1" - 1 1/2"		VES-275-1-U403
	6" - 20"	VBO-150-2-U351														

### Branch (see notes)

RUN SIZE	<table border="1" style="width: 100%; border-collapse: collapse;"> <tr><td>1</td><td>TEE</td></tr> <tr><td>1.5</td><td>RTEE TEE</td></tr> <tr><td>2</td><td>RTEE RTEE TEE</td></tr> <tr><td>2.5</td><td>RTEE RTEE RTEE TEE</td></tr> <tr><td>3</td><td>FSDL RTEE RTEE RTEE TEE</td></tr> <tr><td>4</td><td>FSDL FSDL RTEE RTEE RTEE TEE</td></tr> <tr><td>5</td><td>FSDL FSDL FSDL FSDL RTEE RTEE TEE</td></tr> <tr><td>6</td><td>FSDL FSDL FSDL FSDL FSDL RTEE RTEE TEE</td></tr> <tr><td>8</td><td>FSDL FSDL FSDL FSDL FSDL RTEE RTEE TEE</td></tr> <tr><td>10</td><td>FSDL FSDL FSDL FSDL FSDL RTEE RTEE TEE</td></tr> <tr><td>12</td><td>FSDL FSDL FSDL FSDL FSDL RTEE RTEE TEE</td></tr> <tr><td>14</td><td>FSDL FSDL FSDL FSDL FSDL RTEE RTEE TEE</td></tr> <tr><td>16</td><td>FSDL FSDL FSDL FSDL FSDL RTEE RTEE TEE</td></tr> <tr><td>18</td><td>FSDL FSDL FSDL FSDL FSDL RTEE RTEE RTEE TEE</td></tr> <tr><td>20</td><td>FSDL FSDL FSDL FSDL FSDL RTEE RTEE RTEE TEE</td></tr> <tr><td>24</td><td>FSDL FSDL FSDL FSDL FSDL RTEE RTEE RTEE TEE</td></tr> <tr><td>26</td><td>FSDL FSDL FSDL FSDL FSDL RTEE RTEE RTEE TEE</td></tr> <tr><td>28</td><td>FSDL FSDL FSDL FSDL FSDL RTEE RTEE RTEE TEE</td></tr> <tr><td>30</td><td>FSDL FSDL FSDL FSDL FSDL RTEE RTEE RTEE TEE</td></tr> <tr><td>32</td><td>FSDL FSDL FSDL FSDL FSDL RTEE RTEE RTEE TEE</td></tr> <tr><td>36</td><td>FSDL FSDL FSDL FSDL FSDL RTEE RTEE RTEE TEE</td></tr> <tr><td>40</td><td>FSDL FSDL FSDL FSDL FSDL RTEE RTEE RTEE TEE</td></tr> <tr><td>42</td><td>FSDL FSDL FSDL FSDL FSDL RTEE RTEE RTEE TEE</td></tr> <tr><td>44</td><td>FSDL FSDL FSDL FSDL FSDL RTEE RTEE RTEE TEE</td></tr> <tr><td>46</td><td>FSDL FSDL FSDL FSDL FSDL RTEE RTEE RTEE TEE</td></tr> <tr><td>48</td><td>FSDL FSDL FSDL FSDL FSDL RTEE RTEE RTEE TEE</td></tr> <tr><td>52</td><td>FSDL FSDL FSDL FSDL FSDL RTEE RTEE RTEE TEE</td></tr> <tr><td>56</td><td>FSDL FSDL FSDL FSDL FSDL RTEE RTEE RTEE TEE</td></tr> <tr><td>60</td><td>FSDL FSDL FSDL FSDL FSDL RTEE RTEE RTEE TEE</td></tr> <tr><td>64</td><td>FSDL FSDL FSDL FSDL FSDL RTEE RTEE RTEE TEE</td></tr> </table>	1	TEE	1.5	RTEE TEE	2	RTEE RTEE TEE	2.5	RTEE RTEE RTEE TEE	3	FSDL RTEE RTEE RTEE TEE	4	FSDL FSDL RTEE RTEE RTEE TEE	5	FSDL FSDL FSDL FSDL RTEE RTEE TEE	6	FSDL FSDL FSDL FSDL FSDL RTEE RTEE TEE	8	FSDL FSDL FSDL FSDL FSDL RTEE RTEE TEE	10	FSDL FSDL FSDL FSDL FSDL RTEE RTEE TEE	12	FSDL FSDL FSDL FSDL FSDL RTEE RTEE TEE	14	FSDL FSDL FSDL FSDL FSDL RTEE RTEE TEE	16	FSDL FSDL FSDL FSDL FSDL RTEE RTEE TEE	18	FSDL FSDL FSDL FSDL FSDL RTEE RTEE RTEE TEE	20	FSDL FSDL FSDL FSDL FSDL RTEE RTEE RTEE TEE	24	FSDL FSDL FSDL FSDL FSDL RTEE RTEE RTEE TEE	26	FSDL FSDL FSDL FSDL FSDL RTEE RTEE RTEE TEE	28	FSDL FSDL FSDL FSDL FSDL RTEE RTEE RTEE TEE	30	FSDL FSDL FSDL FSDL FSDL RTEE RTEE RTEE TEE	32	FSDL FSDL FSDL FSDL FSDL RTEE RTEE RTEE TEE	36	FSDL FSDL FSDL FSDL FSDL RTEE RTEE RTEE TEE	40	FSDL FSDL FSDL FSDL FSDL RTEE RTEE RTEE TEE	42	FSDL FSDL FSDL FSDL FSDL RTEE RTEE RTEE TEE	44	FSDL FSDL FSDL FSDL FSDL RTEE RTEE RTEE TEE	46	FSDL FSDL FSDL FSDL FSDL RTEE RTEE RTEE TEE	48	FSDL FSDL FSDL FSDL FSDL RTEE RTEE RTEE TEE	52	FSDL FSDL FSDL FSDL FSDL RTEE RTEE RTEE TEE	56	FSDL FSDL FSDL FSDL FSDL RTEE RTEE RTEE TEE	60	FSDL FSDL FSDL FSDL FSDL RTEE RTEE RTEE TEE	64	FSDL FSDL FSDL FSDL FSDL RTEE RTEE RTEE TEE	WOL - Weldolet  TEE - Tee  RTEE - Red Tee  HC - Half Coupling  SOC - Sockolet  FSDL - Flg Saddle  TSDL - Thd Saddle
1	TEE																																																													
1.5	RTEE TEE																																																													
2	RTEE RTEE TEE																																																													
2.5	RTEE RTEE RTEE TEE																																																													
3	FSDL RTEE RTEE RTEE TEE																																																													
4	FSDL FSDL RTEE RTEE RTEE TEE																																																													
5	FSDL FSDL FSDL FSDL RTEE RTEE TEE																																																													
6	FSDL FSDL FSDL FSDL FSDL RTEE RTEE TEE																																																													
8	FSDL FSDL FSDL FSDL FSDL RTEE RTEE TEE																																																													
10	FSDL FSDL FSDL FSDL FSDL RTEE RTEE TEE																																																													
12	FSDL FSDL FSDL FSDL FSDL RTEE RTEE TEE																																																													
14	FSDL FSDL FSDL FSDL FSDL RTEE RTEE TEE																																																													
16	FSDL FSDL FSDL FSDL FSDL RTEE RTEE TEE																																																													
18	FSDL FSDL FSDL FSDL FSDL RTEE RTEE RTEE TEE																																																													
20	FSDL FSDL FSDL FSDL FSDL RTEE RTEE RTEE TEE																																																													
24	FSDL FSDL FSDL FSDL FSDL RTEE RTEE RTEE TEE																																																													
26	FSDL FSDL FSDL FSDL FSDL RTEE RTEE RTEE TEE																																																													
28	FSDL FSDL FSDL FSDL FSDL RTEE RTEE RTEE TEE																																																													
30	FSDL FSDL FSDL FSDL FSDL RTEE RTEE RTEE TEE																																																													
32	FSDL FSDL FSDL FSDL FSDL RTEE RTEE RTEE TEE																																																													
36	FSDL FSDL FSDL FSDL FSDL RTEE RTEE RTEE TEE																																																													
40	FSDL FSDL FSDL FSDL FSDL RTEE RTEE RTEE TEE																																																													
42	FSDL FSDL FSDL FSDL FSDL RTEE RTEE RTEE TEE																																																													
44	FSDL FSDL FSDL FSDL FSDL RTEE RTEE RTEE TEE																																																													
46	FSDL FSDL FSDL FSDL FSDL RTEE RTEE RTEE TEE																																																													
48	FSDL FSDL FSDL FSDL FSDL RTEE RTEE RTEE TEE																																																													
52	FSDL FSDL FSDL FSDL FSDL RTEE RTEE RTEE TEE																																																													
56	FSDL FSDL FSDL FSDL FSDL RTEE RTEE RTEE TEE																																																													
60	FSDL FSDL FSDL FSDL FSDL RTEE RTEE RTEE TEE																																																													
64	FSDL FSDL FSDL FSDL FSDL RTEE RTEE RTEE TEE																																																													
	<table border="1" style="width: 100%; border-collapse: collapse;"> <tr> <td>1</td><td>1.5</td><td>2</td><td>2.5</td><td>3</td><td>4</td><td>6</td><td>8</td><td>10</td><td>12</td><td>14</td><td>16</td><td>18</td><td>20</td><td>24</td><td>26</td><td>28</td><td>30</td><td>32</td><td>36</td><td>40</td><td>42</td><td>44</td><td>46</td><td>48</td><td>52</td><td>56</td><td>60</td><td>64</td> </tr> </table>	1	1.5	2	2.5	3	4	6	8	10	12	14	16	18	20	24	26	28	30	32	36	40	42	44	46	48	52	56	60	64																																
1	1.5	2	2.5	3	4	6	8	10	12	14	16	18	20	24	26	28	30	32	36	40	42	44	46	48	52	56	60	64																																		

### Notes

1	On the spec valve list, it may have valves codes which contain values of process data lower than spec limits. It shall be verified all valve process data (e.g.: pressure, temperature) in order to specify it according the design premisses.
2	See Annex A for valves requirements and general selection criteria.
3	Bolts,nuts and gaskets (only RTJ gaskets) must be Zn-Ni coated according to Annex B.
4	See Annex C for instruments, drains and vents typical piping arrangement.
31	Electrical conductivity/resistivity shall be tested in accordance with ASTM D257. For components requiring electrical conductivity due to external charge generating mechanisms, the surface resistivity shall be 10 <sup>4</sup> 5 ohms or less. For components requiring electrical conductivity due to internal charge generating mechanisms, the volume resistivity shall be 10 <sup>3</sup> ohm-meter or less.
32	GRP piping and fittings must be certified according to level L3 IMO A753 fire endurance test.
33	GRP piping and fittings must be supplied with UV protection.
34	GRP piping and fittings must have Type Approval certified by Classification Societies.
35	Pipes and fittings must be supplied by the same manufacturer, that also shall be responsible for design, fabrication, assembly, inspection, test, repair and comissioning.
36	Plain washers must be used to assembly flanged connections.
37	See Annex H for Minimum Requirements for FRP pipes and fittings.
39	The bolt torque limit shall be informed by manufacturer.
105	Whenever non-metallics valves are used, the spec's pressure-temperature limits may be reduced according annex A (item A.7.6.2).
112	For pipes and fittings may be used as alternative vinyl ester resins. See Annex H.
115	Gaskets shall not be used to assembly butterfly valves API 609 category A, unless required required by the valve manufacturer.
143	Piping material shall be certified and approved by Classification Society for the intended service.Piping in FRP for open drain shall not be used in classified areas, except for overboard purposes.
149	It shall be used internal electrical conductivity liner (C-glass, single veil) for pipes and fittings
160	This spec is not for open drain in classified area, except for overboard.

		OFFSHORE PRODUCTION FACILITIES ENGINEERING GUIDELINES	Doc: I-ET-3010.2Q-1200-200-P4X-001	Revision: Rev 0	Sheet 1 of 2
		OFFSHORE PRODUCTION FACILITIES ENGINEERING GUIDELINES			Issued by: SRGE/ESUP



Services (see notes): PCW - Produced water;	Material: FRP	Class: 16 bar	Standard: B26
--	------------------	------------------	------------------

Pressure Rating (see notes)											
Temperature (°C)	15	120									
Max Pressure (barg)	16	16									

**Pipes and Fittings (see notes)**

Items		Code	Size	Wall	Class	Ends	Standard	Material
<b>Pipes</b>	Pipe	T-408	1" - 36"	acc. manufact.	-	Bell-Spigot Butt-Strap	ISO 14692	FRP - Bisphenol A Epoxy resins reinforced with fiberglass type E or E-CR. Design pressure 16 bar@120°C. SML
	Plug	C09-36	1" - 1 1/2"	-	250	THD	ASME B16.15	ASTM B62 (UNS C83600)
<b>Fittings</b>	Thd Saddle	C52-56	1" - 6"	-	-	-	ISO 14692	FRP - Bisphenol A Epoxy resins reinforced with fiberglass type E or E-CR. Design pressure 16bar@120°C
	Flg Saddle	C51-56						
	90 LR Elbow	C15-56	According to pipe	16 bar	Butt-Strap			
	45 LR Elbow	C16-56						
	Tee	C20-56						
	FRP Stub End	C64-56	2" - 36"	-	-	Butt-Strap		
	FRP Conc. Red.	C61-56						
	FRP Ecc. Red.	C62-56						
Red Tee	C63-56							
<b>Flanges</b>	Blind	F-16-EU	1" - 36"	According to pipe	16 bar	Flat Face	ASTM D4024 - Drilling acc. B16.5/B16.47 CL150	FRP - Bisphenol A Epoxy resins reinforced with fiberglass type E or E-CR. Suitable for 120°C.
	Backing Flange	F-16-YV				Raised Face	Drilling acc. B16.5/B16.47 CL150	ASTM A105 Epoxy coated
<b>Gasket</b>	Flat type	J-150-PC	1" - 36"	-	Class 150	Raised Face	ASME B16.21	Multidirectional Expanded PTFE
<b>Stud &amp; Nuts</b>	Stud and Nuts	P-150-07	1/2" - 1"	-	-	-	ASME B1.1	A194 Gr 2H, Zn-Ni
								A193 B7, Zn-Ni
<b>Bolt</b>	2 x Hex Bolt	H-150-01	1/2" - 1 1/2"	According to pipe	-	-	ASME B1.1	ASTM A193 Gr B7
<b>Paddles</b>	Figure-8 Blank	R8-150-RP	1" - 14"	According to pipe	150	Raised Face ASME B16.5	ASME B16.48	Carbon Steel ASTM A516 GR60 epoxy coated
	Paddle Blank	RA-150-RP	16" - 36"					
	Paddle Spacer	RE-150-RP						



		OFFSHORE PRODUCTION FACILITIES ENGINEERING GUIDELINES	Doc: I-ET-3010.2Q-1200-200-P4X-001	Revision: Rev 0	Sheet 1 of 2
		OFFSHORE PRODUCTION FACILITIES ENGINEERING GUIDELINES		Issued by: SRGE/ESUP	Code: ASME B31.3



Services (see notes): <b>C12</b> - DBNPA Biocide; <b>CN</b> - Sodium Hypochlorite;	Material: FRP	Class: 16 bar	Standard: B27
---	------------------	------------------	------------------

**Pressure Rating (see notes)**

Temperature (°C)	15	85									
Max Pressure (barg)	16	16									

**Pipes and Fittings (see notes)**

Items		Code	Size	Wall	Class	Ends	Standard	Material
Pipes	Pipe	T-409	1" - 6"	acc. manufact.	-	Butt-Strap Bell-Spigot	ISO 14692	FRP - Epoxy vinyl ester resins (bisphenol A brominated) reinforced with fiberglass type E-CR, inner liner with fiberglass veils type C. Design pressure 16 bar@85°C. SML
	Thd Saddle	C52-57	1" - 1 1/2"	-	-	-	ISO 14692	FRP - Epoxy vinyl ester resins (bisphenol A or brominated) reinforced with fiberglass type E-CR, inner liner with fiberglass veils type C. Design pressure 16 bar@85°C
Fittings	Flg Saddle	C51-57	1" - 4"	-	-	-		
	90 LR Elbow	C15-57	1" - 6"	According to pipe	16 bar	Butt-Strap		
	45 LR Elbow	C16-57						
	Tee	C20-57	-	-				
	Red Tee	C63-57	2" - 3"	-				
	FRP Conc. Red.	C61-57	2" - 6"	-				
FRP Ecc. Red.	C62-57	-	-					
Flanges	Blind	F-16-ES	1" - 6"	According to pipe	16 bar	Flat Face	ASTM D4024 - Drilling acc. B16.5/B16.47 CL150	FRP - Epoxy vinyl ester resins (bisphenol A or brominated) reinforced with fiberglass type E-CR. Suitable for 85°C.
	Integral Flange	F-16-1S						
Gasket	Flat type	J-150-CC	1" - 6"	-	Class 150	Flat Face	ASME B16.21	Multidirectional Expanded PTFE
Stud & Nuts	Stud and Nuts	P-150-07	1/2" - 3/4"	-	-	-	ASME B1.1	A194 Gr 2H, Zn-Ni
								A193 B7, Zn-Ni
Paddles	Figure-8 Blank	R8-150-FP	1" - 6"	According to pipe	150	Flat Face ASME B16.5	ASME B16.48	Carbon Steel ASTM A516 GR60 epoxy coated

		OFFSHORE PRODUCTION FACILITIES ENGINEERING GUIDELINES	Doc: I-ET-3010.2Q-1200-200-P4X-001	Revision: Rev 0	Sheet: 2 of 2
		OFFSHORE PRODUCTION FACILITIES ENGINEERING GUIDELINES	Material: FRP	Class: 16 bar	Standard: B27

### Valves (see notes)

Type	Size	CODE	Temp	Type	Size	CODE	Temp	Type	Size	CODE	Temp	Type	Size	CODE	Temp
Ball	1" - 6"	VES-150-2-U600	0C to 70C	Check	2" - 6"	VRE-150-2-U666	0C to 70C								



### Branch (see notes)

RUN SIZE	1	TEE													
	1.5	RTEE	RTEE	TEE											
	2	RTEE	RTEE	TEE											
	2.5	RTEE	RTEE	RTEE	TEE										
	3	FSDL	RTEE	RTEE	RTEE	TEE									
	4	FSDL	FSDL	FSDL	FSDL	FSDL	TEE								
6	FSDL	FSDL	FSDL	FSDL	FSDL	FSDL	TEE								
	1	1.5	2	2.5	3	4	6								
	BRANCH SIZE														

- WOL - Weldolet
- TEE - Tee
- RTEE - Red Tee
- HC - Half Coupling
- SOC - Sockolet
- FSDL - Flg Saddle
- TSDL - Thd Saddle

### Notes

1	On the spec valve list, it may have valves codes which contain values of process data lower than spec limits. It shall be verified all valve process data (e.g.: pressure, temperature) in order to specify it according the design premisses.
2	See Annex A for valves requirements and general selection criteria.
3	Bolts,nuts and gaskets (only RTJ gaskets) must be Zn-Ni coated according to Annex B.
4	See Annex C for instruments, drains and vents typical piping arrangement.
31	Electrical conductivity/resistivity shall be tested in accordance with ASTM D257. For components requiring electrical conductivity due to external charge generating mechanisms, the surface resistivity shall be 10 <sup>4</sup> 5 ohms or less. For components requiring electrical conductivity due to internal charge generating mechanisms, the volume resistivity shall be 10 <sup>4</sup> 3 ohm-meter or less.
32	GRP piping and fittings must be certified according to level L3 IMO A753 fire endurance test.
33	GRP piping and fittings must be supplied with UV protection.
34	GRP piping and fittings must have Type Approval certified by Classification Societies.
35	Pipes and fittings must be supplied by the same manufacturer, that also shall be responsible for design, fabrication, assembly, inspection, test, repair and comissioning.
36	Plain washers must be used to assembly flanged connections.
37	See Annex H for Minimum Requirements for FRP pipes and fittings.
39	The bolt torque limit shall be informed by manufacturer.
66	It's not allowed to use overwrap joints (adhesive joint covered by fiber-resin layers).
105	Whenever non-metallics valves are used, the spec's pressure-temperature limits may be reduced according annex A (item A.7.6.2).
143	Piping material shall be certified and approved by Classification Society for the intended service.Piping in FRP for open drain shall not be used in classified areas, except for overboard purposes.

		OFFSHORE PRODUCTION FACILITIES ENGINEERING GUIDELINES	Doc: I-ET-3010.2Q-1200-200-P4X-001	Revision: Rev 0	Sheet 1 of 2
		OFFSHORE PRODUCTION FACILITIES ENGINEERING GUIDELINES			Issued by: SRGE/ESUP

Services (see notes): W- Industrial water;	Material: FRP	Class: 20 bar	Standard: B28
---	------------------	------------------	------------------

Pressure Rating (see notes)										
Temperature (°C)	90									
Max Pressure (barg)	25									

Pipes and Fittings (see notes)											
Items	Code	Size	Wall	Class	Ends	Standard	Material				
Pipes	Pipe	T-410	acc. manufact.	-	Bell-Spigot	ISO 14692	FRP - Bisphenol A Epoxy resins reinforced with fiberglass type E or E-CR. Design pressure 25 bar@90°C. SML				
					Butt-Strap						
					Bell-Spigot						
					Butt-Strap						
					Bell-Spigot						
					Butt-Strap						
Fittings	Plug	C09-36	1" - 1 1/2"	-	250	THD	ASME B16.15	ASTM B62 (UNS C83600)			
	Thd Saddle	C52-64	1" - 6"	-	-	-	ISO 14692	FRP - Bisphenol A Epoxy resins reinforced with fiberglass type E or E-CR. Design pressure 25bar@90°C			
	Flg Saddle	C51-64	1" - 6"	According to pipe	25 bar	Butt-Strap					
	90 LR Elbow	C15-64	1" - 28"								
	45 LR Elbow	C16-64	1" - 28"								
	Tee	C20-64	1" - 28"								
	FRP Stub End	C64-54	1" - 48"	-	16 bar	BellSpigot				FRP - Bisphenol A Epoxy resins reinforced with fiberglass type E or E-CR. Design pressure 16bar@90°C	
	FRP Conc. Red.	C61-64	2" - 28"	-	25 bar	Butt-Strap				FRP - Bisphenol A Epoxy resins reinforced with fiberglass type E or E-CR. Design pressure 25bar@90°C	
FRP Ecc. Red.	C62-64										
Red Tee	C63-64										
Flanges	Blind	F-16-LT	1" - 48"	According to pipe	16 bar	Raised Face	ASTM D4024 - Drilling acc. B16.5/B16.47 CL150	FRP - Bisphenol A Epoxy resins reinforced with fiberglass type E or E-CR. Suitable for 90°C.			
	Backing Flange	F-16-YV	1" - 40"				Drilling acc. B16.5/B16.47 CL150	ASTM A105 Epoxy coated			
Gasket	Flat type	J-150-P3	1" - 40"	-	Class 150	Raised Face	ASME B16.21	Neoprene			
Stud & Nuts	Stud and Nuts	P-150-07	1/2" - 1 1/2"	-	-	-	ASME B1.1	A194 Gr 2H, Zn-Ni			
Bolt	2 x Hex Bolt	H-150-01	1/2" - 1 1/2"	According to pipe	-	-	ASME B1.1	A193 B7, Zn-Ni			
	Figure-8 Blank	R8-150-RP	1" - 14"	According to pipe	150	Raised Face ASME B16.5	ASME B16.48	Carbon Steel ASTM A516 GR60 epoxy coated			
Paddle Blank	RA-150-RP	16" - 40"									
Paddle Spacer	RE-150-RP										





OFFSHORE PRODUCTION FACILITIES ENGINEERING GUIDELINES

Doc:  
I-ET-3010.2Q-1200-200-P4X-001

Revision:  
Rev 0

Sheet:  
2 of 2

OFFSHORE PRODUCTION FACILITIES ENGINEERING GUIDELINES

Material:  
FRP

Class:  
20 bar

Standard:  
B28

Valves (see notes)

Type	Size	CODE	Temp	Type	Size	CODE	Temp	Type	Size	CODE	Temp	Type	Size	CODE	Temp
Butterfly	2" - 20"	VBO-250-1-U291	0C to 75C	Butterfly	6" - 20"	VBO-150-2-C111	-29C to 150C	Butterfly	6" - 20"	VBO-150-2-C151	-29C to 150C	Butterfly	6" - 20"	VBO-150-3-C121	-29C to 240C
	24" - 40"	VBO-250-1-U293			24" - 36"	VBO-150-2-C113	-29C to 200C		24" - 36"	VBO-150-2-C153	24" - 36"		VBO-150-3-C123		



Branch (see notes)

RUN SIZE	1	TEE	BRANCH SIZE	1	1
	1.5	RTEE		1.5	1.5
	2	RTEE		2	2
	2.5	FSDL		2.5	2.5
	3	FSDL		3	3
	4	FSDL		4	4
	5	FSDL		5	5
	6	FSDL		6	6
	8	FSDL		8	8
	10	FSDL		10	10
	12	FSDL		12	12
	14	FSDL		14	14
	16	FSDL		16	16
	18	FSDL		18	18
	20	FSDL		20	20
	24	FSDL		24	24
	26	FSDL		26	26
	28	FSDL		28	28
	30	FSDL		30	30
	32	FSDL		32	32
34	FSDL	34	34		
36	FSDL	36	36		
40	FSDL	40	40		

WOL - Weldolet  
TEE - Tee  
RTEE - Red Tee  
HC - Half Coupling  
SOC - Sockolet

Notes

1	On the spec valve list, it may have valves codes which contain values of process data lower than spec limits. It shall be verified all valve process data (e.g.: pressure, temperature) in order to specify it according the design premisses.
2	See Annex A for valves requirements and general selection criteria.
3	Bolts,nuts and gaskets (only RTJ gaskets) must be Zn-Ni coated according to Annex B.
4	See Annex C for instruments, drains and vents typical piping arrangement.
31	Electrical conductivity/resistivity shall be tested in accordance with ASTM D257. For components requiring electrical conductivity due to external charge generating mechanisms, the surface resistivity shall be 10^5 ohms or less. For components requiring electrical conductivity due to internal charge generating mechanisms, the volume resistivity shall be 10^3 ohm-meter or less.
32	GRP piping and fittings must be certified according to level L3 IMO A753 fire endurance test.
33	GRP piping and fittings must be supplied with UV protection.
34	GRP piping and fittings must have Type Approval certified by Classification Societies.
35	Pipes and fittings must be supplied by the same manufacturer, that also shall be responsible for design, fabrication, assembly, inspection, test, repair and comissioning.
36	Plain washers must be used to assembly flanged connections.
37	See Annex H for Minimum Requirements for FRP pipes and fittings.
39	The bolt torque limit shall be informed by manufacturer.
105	Whenever non-metallics valves are used, the spec's pressure-temperature limits may be reduced according annex A (item A.7.6.2).
112	For pipes and fittings may be used as alternative vinyl ester resins. See Annex H.
115	Gaskets shall not be used to assembly butterfly valves API 609 category A, unless required required by the valve manufacturer.
149	It shall be used internal electrical conductivity liner (C-glass, single veil) for pipes and fittings

 <b>PETROBRAS</b>		OFFSHORE PRODUCTION FACILITIES ENGINEERING GUIDELINES				Doc: I-ET-3010.2Q-1200-200-P4X-001	Revision: Rev 0	Sheet 1 of 2
		OFFSHORE PRODUCTION FACILITIES ENGINEERING GUIDELINES						Issued by: SRGE/ESUP



Services (see notes): F - Safety System and Flare; IW - De-Aerated Sea Water Injection; PC - Process (Corrosive Hydrocarbon);	Material: CS Inconel Clad.	Class: 150	Standard: B30
--	-------------------------------	---------------	------------------

Pressure Rating (see notes)										
Temperature (°C)	0	38	50	100	150	200	240			
Max Pressure (barg)	19.6	19.6	19.2	17.7	15.8	13.8	12.4			

**Pipes and Fittings (see notes)**

Items	Code	Size	Wall	Class	Ends	Standard	Material								
Pipes	T-203	1/2" - 1 1/2"	S-40S	-	PE	ASME B36.10/B36.19	ASTM B444 Gr 1 (UNS N06625) SML								
		2" - 3"			BE			ASME B36.10	API 5L Gr B PSL 1 (SML or WLD HFW or WLD SAW)						
		4" - 6"	S-10			ASME B36.10	API 5L Gr B PSL 1 WLD (HFW or SAW)								
		8" - 12"			T-102			S-10	API 5L Gr B PSL 1 WLD SAW						
	14"														
	16" - 18"														
	20"														
	24"														
	26" - 28"														
	30"	0.344"													
Fittings	90 Elbow	C01-33	1/2" - 1 1/2"	-	3000	SW	ASME B16.11								
	45 Elbow	C02-33													
	Tee	C03-33													
	Cross	C05-33													
	Coupling	C06-33													
	Cap	C11-33													
	Socket	C55-33													
	Red Tee	C04-33													
	Red Coupling	C08-33													
	90 LR Elbow	C15-33						2" - 3"	-	-	BE	ASME B16.9			
	45 LR Elbow	C16-33													
	90 SR Elbow	C17-33													
	Tee	C20-33													
	Cap	C22-33													
	Cross	C24-33													
	Weldolet	C12-33	2" - 4"	-	-	-	MSS SP-97								
		C12-02											3" - 4"	-	-
	Conc. Red	C18-33	4" - 30"	According to pipe	-	-	ASME B16.9								
	Ecc. Red	C19-33													
	Red Tee	C21-33													
	90 LR Elbow	C15-03													
	45 LR Elbow	C16-03													
	90 SR Elbow	C17-03													
	Tee	C20-03													
	Cap	C22-03													
	Cross	C24-03													
	Conc. Red	C18-03						6" - 30"	-	-	-	-			
	Ecc. Red	C19-03													
Red Tee	C21-03														
Nipple	Straight Nipple	N-S139	1/2" - 1 1/2"	According to pipe	-	PBE	ASTM A733								
	Swage Conc Nipple	N-C133	3/4" - 1 1/2"					-	-	-	ASTM B444 Gr 1 (UNS N06625)				
		N-C433	2" - 4"									According to pipe	-	-	MSS SP-95
	Swage Ecc Nipple	N-E133	3/4" - 1 1/2"					-	-	-	ASTM B366 (UNS N06625)				
		N-E433	2" - 4"												
Flanges	Socket Weld (SW)	F-150-JL	1/2" - 1 1/2"	According to pipe	Class 150	Raised Face	ASME B16.5								
	Welding Neck (WN)	F-150-KL	2" - 3"					-	-	-	ASTM B564 (UNS N06625)				
		F-150-KB	4" - 30"									-	-	-	ASTM A105 Cladded
	Blind	F-150-LB	4" - 24"					-	-	-	-				
26" - 30"															
Gasket	Spiral-Wound	J-150-EM	1/2" - 30"	-	Class 150	Raised Face	ASME B16.20	Inconel/graphite							
Stud & Nuts	Stud and Nuts	P-150-07	1/2" - 1 1/4"	-	-	-	ASME B1.1	A194 Gr 2H, Zn-Ni							
								A193 B7, Zn-Ni							
Bolt	2 x Hex Bolt	H-150-01	1/2" - 1 1/2"	According to pipe	-	-	ASME B1.1	ASTM A193 Gr B7							
Paddles	Figure-8 Blank	R8-150-RI	1/2" - 14"	According to pipe	150	Raised Face ASME B16.5	ASME B16.48	Carbon Steel ASTM A516 GR60 with Inconel 625 layer							
	Paddle Spacer	RE-150-RI	16" - 30"												



 <b>PETROBRAS</b>		<b>OFFSHORE PRODUCTION FACILITIES ENGINEERING GUIDELINES</b>				Doc: I-ET-3010.2Q-1200-200-P4X-001	Revision: Rev 0	Sheet 1 of 2
		<b>OFFSHORE PRODUCTION FACILITIES ENGINEERING GUIDELINES</b>					Issued by: SRGE/ESUP	Code: ASME B31.3



Services (see notes): <b>F</b> - Safety System and Flare; <b>G</b> - Glycol; <b>GL</b> - Refrigerated Liquefied Petroleum Gases in Low Temperature; <b>P</b> - Process (non-corrosive hydrocarbon);	Material: <b>Low Temp CS</b>	Class: <b>300</b>	Standard: <b>C6</b>
--	---------------------------------	----------------------	------------------------

Pressure Rating (see notes)										
Temperature (°C)	-46	0	38	50	100	150	200			
Max Pressure (barg)	51.1	51.1	51.1	50.1	46.6	45.1	43.8			

**Pipes and Fittings (see notes)**

Items	Code	Size	Wall	Class	Ends	Standard	Material						
Pipes	T-105	1/2" - 1 1/2"	S-160	-	PE	ASME B36.10	ASTM A333 Gr 6 SML						
		2" - 6"	STD		BE								
		8" - 10"	S-30										
		12"	0.344"										
	T-106	14"	STD										
		16"	STD										
		18"	0.406"										
		20"	0.438"										
		24"	S-30										
Fittings	90 Elbow	C01-04	1/2" - 1 1/2"	-	6000	SW	ASTM A350 Gr LF2 Cl 1						
	45 Elbow	C02-04											
	Tee	C03-04											
	Cross	C05-04											
	Coupling	C06-04											
	Cap	C11-04											
	Socket	C55-04											
	Red Tee	C04-04											
	90 LR Elbow	C15-05	2" - 24"	According to pipe	-	BE	ASTM A420 Gr WPL6						
	45 LR Elbow	C16-05											
	90 SR Elbow	C17-05											
	Tee	C20-05											
	Cap	C22-05											
	Cross	C24-05											
	Conc. Red	C18-05											
	Ecc. Red	C19-05											
Red Tee	C21-05	3" - 24"	-	-	-	-							
Nipple	Straight Nipple						N-S137	1/2" - 1 1/2"	According to pipe	-	PBE	ASTM A733	ASTM A333 Gr 6
	Swage Conc Nipple						N-C105	3/4" - 1 1/2"			BLE x PSE	MSS SP-95	ASTM A420 Gr WPL6
Swage Ecc Nipple	N-E105						3/4" - 1 1/2"	PBE					
		N-E405	2" - 4"	BLE x PSE									
Flanges	Socket Weld (SW)	F-300-J3	1/2" - 1 1/2"	According to pipe	Class 300	Raised Face	ASME B16.5	ASTM A350 Gr LF2 Class 1					
	Welding Neck (WN)	F-300-K3	2" - 24"										
	Blind	F-300-L3	1/2" - 24"										
Gasket	Spiral-Wound	J-300-EH	1/2" - 24"	-	Class 300	Raised Face	ASME B16.20	AISI 316/graphite					
Stud & Nuts	Stud and Nuts	P-300-07	1/2" - 1 1/2"	-	-	-	ASME B1.1	A194 Gr 2H, Zn-Ni A193 B7, Zn-Ni					
Bolt	2 x Hex Bolt	H-300-01	1/2" - 1 7/8"	According to pipe	-	-	ASME B1.1	ASTM A193 Gr B7					
Paddles	Figure-8 Blank	R8-300-RL	1/2" - 10"	According to pipe	300	Raised Face ASME B16.5	ASME B16.48	Low Temp. Carbon Steel ASTM A516 70 + S5					
	Paddle Blank	RA-300-RL											
	Paddle Spacer	RE-300-RL	12" - 24"										



		OFFSHORE PRODUCTION FACILITIES ENGINEERING GUIDELINES	Doc: I-ET-3010.2Q-1200-200-P4X-001	Revision: Rev 0	Sheet 1 of 2
		OFFSHORE PRODUCTION FACILITIES ENGINEERING GUIDELINES			Issued by: SRGE/ESUP



Services (see notes): <b>DO - Carbon Dioxide (DRY);</b>	Material: <b>Galv. CS</b>	Class: <b>300</b>	Standard: <b>C8</b>
--	------------------------------	----------------------	------------------------

Pressure Rating (see notes)										
Temperature (°C)	-18	0	38	54						
Max Pressure (barg)	51.1	51.1	51.1	49.8						

**Pipes and Fittings (see notes)**

Items		Code	Size	Wall	Class	Ends	Standard	Material		
<b>Pipes</b>	Pipe	T-102	1/2" - 1 1/2"	XS	-	PE	ASME B36.10	API 5L Gr B PSL 1 SML		
			2" - 6"	STD		BE		API 5L Gr B PSL 1 (SML or WLD HFW or WLD SAW)		
			8"	S-20						
<b>Fittings</b>	90 Elbow	C01-02	1/2" - 1 1/2"	-	3000	SW	ASME B16.11	ASTM A105		
	45 Elbow	C02-02								
	Tee	C03-02								
	Cross	C05-02								
	Coupling	C06-02								
	Union	C10-02								
	Cap	C11-02								
	Socket	C55-02								
	Red Tee	C04-02	3/4" - 1 1/2"							
	Red Coupling	C08-02								
	Weldolet	C12-02	2" - 8"	According to pipe	-	BE	ASME B16.9	ASTM A234 Gr WPB		
	90 LR Elbow	C15-03								
	45 LR Elbow	C16-03								
	90 SR Elbow	C17-03								
	Tee	C20-03								
	Cap	C22-03								
	Cross	C24-03								
	Conc. Red	C18-03								
Ecc. Red	C19-03	3" - 8"								
Red Tee	C21-03									
<b>Nipple</b>	Straight Nipple	N-S120	1/2" - 1 1/2"	According to pipe	-	PBE	ASTM A733	API 5L Gr B PSL 1 seamless		
	Swage Conc Nipple	N-C103	3/4" - 1 1/2"			BLE x PSE	MSS SP-95		ASTM A234 Gr WPB	
		N-C403	2" - 4"							
	Swage Ecc Nipple	N-E103	3/4" - 1 1/2"			2" - 4"				
		N-E403	2" - 4"							
<b>Flanges</b>	Welding Neck (WN)	F-300-K2	2" - 8"	According to pipe	Class 300	Raised Face	ASME B16.5	ASTM A105		
	Blind	F-300-L2	1/2" - 8"							
<b>Gasket</b>	Flat type	J-300-PA	1/2" - 8"	-	Class 300	Raised Face	ASME B16.21	Aramid/NBR		
<b>Stud &amp; Nuts</b>	Stud and Nuts	P-300-07	1/2" - 7/8"	-	-	-	ASME B1.1	A194 Gr 2H, Zn-Ni		
<b>Bolt</b>	2 x Hex Bolt	H-300-01	1/2" - 1 7/8"	According to pipe	-	-	ASME B1.1	A193 B7, Zn-Ni		
<b>Paddles</b>	Figure-8 Blank	R8-300-RC	1/2" - 8"	According to pipe	300	Raised Face ASME B16.5	ASME B16.48	Carbon Steel ASTM A516 GR60		



 <b>PETROBRAS</b>		<b>OFFSHORE PRODUCTION FACILITIES ENGINEERING GUIDELINES</b>				Doc: <b>I-ET-3010.2Q-1200-200-P4X-001</b>	Revision: <b>Rev 0</b>	Sheet <b>1 of 2</b>
		<b>OFFSHORE PRODUCTION FACILITIES ENGINEERING GUIDELINES</b>					Issued by: <b>SRGE/ESUP</b>	Code: <b>ASME B31.3</b>

Services (see notes): <b>AM</b> - Amine; <b>BG</b> - Inert Gas; <b>CI</b> - Chemical Injection (non-corrosive); <b>D</b> - Diesel; <b>FG</b> - Fuel Gas; <b>G</b> - Glycol; <b>IW</b> - De-Aerated Sea Water Injection; <b>P</b> - Process (non-corrosive hydrocarbon); <b>RF</b> - Refrigerant Fluid; <b>SA</b> - Service Compressed Air (utility Air); <b>SN</b> - Start-up Nitrogen; <b>W</b> - Industrial water;	Material: <b>Carbon Steel</b>	Class: <b>300</b>	Standard: <b>C10</b>
---	----------------------------------	----------------------	-------------------------



<b>Pressure Rating (see notes)</b>										
<b>Temperature (°C)</b>	0	38	50	100	150	200	240			
<b>Max Pressure (barg)</b>	51.1	51.1	50.1	46.6	45.1	43.8	42.2			

**Pipes and Fittings (see notes)**

Items	Code	Size	Wall	Class	Ends	Standard	Material						
Pipes	Pipe	T-102	1/2" - 1 1/2"	S-160	-	PE	API 5L Gr B PSL 1 SML						
			2" - 12"	STD		BE		ASME B36.10	API 5L Gr B PSL 1 (SML or WLD HFW or WLD SAW)				
			14"	0.406"									
			16"	0.469"									
			18"	XS									
			20"	0.562"									
			24"	S-40									
			26"	0.625"									
			28"	0.688"									
30" - 32"	0.750"												
Fittings	90 Elbow	C01-02	1/2" - 1 1/2"	-	6000	SW	ASME B16.11	ASTM A105					
	45 Elbow	C02-02											
	Tee	C03-02											
	Cross	C05-02											
	Coupling	C06-02											
	Cap	C11-02											
	Socketlet	C55-02	3/4" - 1 1/2"	-	-	-	-	-					
	Red Tee	C04-02											
	Red Coupling	C08-02											
	Weldolet	C12-02	2" - 14"	According to pipe	-	BE	ASME B16.9	ASTM A234 Gr WPB					
	90 LR Elbow	C15-03											
	45 LR Elbow	C16-03											
	90 SR Elbow	C17-03											
	Tee	C20-03											
	Cap	C22-03											
	Cross	C24-03											
	Conc. Red	C18-03											
	Ecc. Red	C19-03											
Red Tee	C21-03												
Nipple	Straight Nipple	N-S120	1" - 1 1/2"						According to pipe	-	PBE	ASTM A733	API 5L Gr B PSL 1 seamless
	Swage Conc Nipple	N-C103	3/4" - 1 1/2"								BLE x PSE	MSS SP-95	ASTM A234 Gr WPB
		N-C403	2" - 4"										
	Swage Ecc Nipple	N-E103	3/4" - 1 1/2"	2" - 4"	PBE	-	-						
N-E403		2" - 4"											
Flanges	Socket Weld (SW)	F-300-J2	1/2" - 1 1/2"	According to pipe	Class 300	Raised Face	ASME B16.5	ASTM A105					
	Welding Neck (WN)	F-300-K2	2" - 24"			ASME B16.47 A							
			26" - 32"										
Blind	F-300-L2	1/2" - 32"	-										
Gasket	Spiral-Wound	J-300-EH	1/2" - 32"	-	Class 300	Raised Face	ASME B16.20	AISI 316/graphite					
Stud & Nuts	Stud and Nuts	P-300-07	1/2" - 1 7/8"	-	-	-	ASME B1.1	A194 Gr 2H, Zn-Ni					
							ASTM A193 Gr B7, Zn-Ni						
Bolt	2 x Hex Bolt	H-300-01	1/2" - 1 7/8"	According to pipe	-	-	ASME B1.1	ASTM A193 Gr B7					
Paddles	Figure-8 Blank	R8-300-RC	1/2" - 10"	According to pipe	300	Raised Face ASME B16.5	ASME B16.48	Carbon Steel ASTM A516 GR60					
	Paddle Blank	RA-300-RC											
	Paddle Spacer	RE-300-RC											





		OFFSHORE PRODUCTION FACILITIES ENGINEERING GUIDELINES	Doc: I-ET-3010.2Q-1200-200-P4X-001	Revision: Rev 0	Sheet 1 of 2
		OFFSHORE PRODUCTION FACILITIES ENGINEERING GUIDELINES			Issued by: SRGE/ESUP



Services (see notes): <b>ADW</b> - Aerated Dilution Water; <b>PC</b> - Process (Corrosive Hydrocarbon); <b>PCW</b> - Produced water;	Material: <b>Organic Coat CS</b>	Class: <b>300</b>	Standard: <b>C11</b>
---	-------------------------------------	----------------------	-------------------------

Pressure Rating (see notes)										
Temperature (°C)	0	38	50	100	150					
Max Pressure (barg)	51.1	51.1	50.1	46.6	45.4					

**Pipes and Fittings (see notes)**

Items	Code	Size	Wall	Class	Ends	Standard	Material		
Pipes	Pipe	T-102	3" - 6"	STD	-	BE	ASME B36.10	API 5L Gr B PSL 1 (SML or WLD HFW or WLD SAW)	
			8"	S-20					
			10"	0.279"					
			12"	0.312"					
			14"	0.344"					
			16"	0.406"					
			18"	0.469"					
		20"	XS				API 5L Gr B PSL 1 WLD (HFW or SAW)		
Fittings	Weldolet	C12-02	3" - 8"	According to pipe	-	BE	ASME B16.9	MSS SP-97	ASTM A105
	90 LR Elbow	C15-03	3" - 20"					ASTM A234 Gr WPB	
	45 LR Elbow	C16-03							
	90 SR Elbow	C17-03							
	Tee	C20-03							
	Cap	C22-03							
	Cross	C24-03							
	Conc. Red	C18-03							
	Ecc. Red	C19-03	4" - 20"						
Red Tee	C21-03								
Flanges	Welding Neck (WN)	F-300-K2	3" - 20"	According to pipe	Class 300	Raised Face	ASME B16.5	ASTM A105	
	Blind	F-300-L2					-		
Gasket	Flat type	J-300-PC	3" - 20"	-	Class 300	Raised Face	ASME B16.21	Multidirectional Expanded PTFE	
Stud & Nuts	Stud and Nuts	P-300-07	1/2" - 1 1/4"	-	-	-	ASME B1.1	A194 Gr 2H, Zn-Ni	
								A193 B7, Zn-Ni	
Bolt	2 x Hex Bolt	H-300-01	1/2" - 1 1/8"	According to pipe	-	-	ASME B1.1	ASTM A193 Gr B7	
Paddles	Figure-8 Blank	R8-300-RP	3" - 10"	According to pipe	300	Raised Face ASME B16.5	ASME B16.48	Carbon Steel ASTM A516 GR60 epoxy coated	
	Paddle Blank	RA-300-RP	12" - 20"						
	Paddle Spacer	RE-300-RP							



 <b>PETROBRAS</b>		OFFSHORE PRODUCTION FACILITIES ENGINEERING GUIDELINES	Doc: I-ET-3010.2Q-1200-200-P4X-001	Revision: Rev 0	Sheet 1 of 2
		OFFSHORE PRODUCTION FACILITIES ENGINEERING GUIDELINES			Issued by: SRGE/ESUP



Services (see notes): <b>AM</b> - Amine; <b>PC</b> - Process (Corrosive Hydrocarbon); <b>PCW</b> - Produced water;	Material: <b>Duplex</b>	Class: <b>300</b>	Standard: <b>C16</b>
---	----------------------------	----------------------	-------------------------

Pressure Rating (see notes)										
Temperature (°C)	-46	0	38	50	100	150				
Max Pressure (barg)	51.7	51.7	51.7	51.7	50.7	45.9				

**Pipes and Fittings (see notes)**

Items	Code	Size	Wall	Class	Ends	Standard	Material					
Pipes	T-301	1/2" - 1 1/2"	S-40S	-	PE	ASME B36.10/B36.19	ASTM A790 (UNS S31803) SML					
		2" - 8"										
		10" - 20"										
	T-302	22"						-	BE	ASME B36.10/B36.19	ASTM A928 (UNS S31803 Cl 1 or 3) WLD	
		24"										
		26" - 28"										0.375"
		30"										0.406"
		32"	0.438"									
Fittings	90 Elbow	C01-27	1/2" - 1 1/2"	-	3000	SW	ASME B16.11	ASTM A182 Gr F51 (UNS S31803)				
	45 Elbow	C02-27										
	Tee	C03-27										
	Cross	C05-27										
	Coupling	C06-27										
	Cap	C11-27										
	Socket	C55-27										
	Red Tee	C04-27	3/4" - 1 1/2"	-	3000	SW	ASME B16.11	ASTM A182 Gr F51 (UNS S31803)				
	Red Coupling	C08-27										
	Weldolet	C12-27										
	90 LR Elbow	C15-29	2" - 32"	According to pipe	-	BE	ASME B16.9	ASTM A815 (UNS S31803)				
	45 LR Elbow	C16-29										
	90 SR Elbow	C17-29										
	Tee	C20-29										
	Cap	C22-29										
	Cross	C24-29										
	Conc. Red	C18-29										
Ecc. Red	C19-29	3" - 32"	-	-	BE	ASME B16.9	ASTM A815 (UNS S31803)					
Red Tee	C21-29											
Nipple	Straight Nipple	N-S128	1/2" - 1 1/2"	According to pipe	-	PBE	ASTM A733	ASTM A790 (UNS S31803)				
	Swage Conc Nipple	N-C129	3/4" - 1 1/2"									
	Swage Ecc Nipple	N-E129	3/4" - 1 1/2"									
		N-E429	2" - 4"									
Flanges	Socket Weld (SW)	F-300-JG	1/2" - 1 1/2"	According to pipe	Class 300	Raised Face	ASME B16.5	ASTM A182 Gr F51				
	Welding Neck (WN)	F-300-KG	2" - 32"									
	Blind	F-300-LG	1/2" - 32"									
Gasket	Spiral-Wound	J-300-EL	1/2" - 32"	-	Class 300	Raised Face	ASME B16.20	Duplex/graphite				
Stud & Nuts	Stud and Nuts	P-300-07	1/2" - 1 1/2"	-	-	-	ASME B1.1	A194 Gr 2H, Zn-Ni				
								A193 B7, Zn-Ni				
Bolt	2 x Hex Bolt	H-300-01	1/2" - 1 1/8"	According to pipe	-	-	ASME B1.1	ASTM A193 Gr B7				
Paddles	Figure-8 Blank	R8-300-RD	1/2" - 10"	According to pipe	300	Raised Face ASME B16.5	ASME B16.48	Duplex Stainless Steel ASTM A240 UNS31803				
	Paddle Blank	RA-300-RD	12" - 32"									
	Paddle Spacer	RE-300-RD										



		OFFSHORE PRODUCTION FACILITIES ENGINEERING GUIDELINES	Doc: I-ET-3010.2Q-1200-200-P4X-001	Revision: Rev 0	Sheet 1 of 2
		OFFSHORE PRODUCTION FACILITIES ENGINEERING GUIDELINES			Issued by: SRGE/ESUP

Services (see notes): <b>ADW</b> - Aerated Dilution Water; <b>SW</b> - Aerated Sea Water;	Material: FRP	Class: 25 bar	Standard: C23
--	------------------	------------------	------------------



**Pressure Rating (see notes)**

Temperature (°C)	90										
Max Pressure (barg)	25										

**Pipes and Fittings (see notes)**

Items		Code	Size	Wall	Class	Ends	Standard	Material
<b>Pipes</b>	Pipe	T-410	1" - 28"	acc. manufact.	-	Butt-Strap Bell-Spigot	ISO 14692	FRP - Bisphenol A Epoxy resins reinforced with fiberglass type E or E-CR. Design pressure 25 bar@90°C. SML
	Plug	C09-36	1" - 1 1/2"	-	250	THD	ASME B16.15	ASTM B62 (UNS C83600)
<b>Fittings</b>	Thd Saddle	C52-64	1" - 6"	-	-	-	-	FRP - Bisphenol A Epoxy resins reinforced with fiberglass type E or E-CR. Design pressure 25bar@90°C
	Flg Saddle	C51-64						
	90 LR Elbow	C15-64	1" - 28"	According to pipe	25 bar	Butt-Strap	ISO 14692	
	45 LR Elbow	C16-64						
	Tee	C20-64						
	FRP Stub End	C64-64						
	FRP Conc. Red.	C61-64						
FRP Ecc. Red.	C62-64	2" - 28"	-	-	-	-		
Red Tee	C63-64							
<b>Flanges</b>	Blind	F-25-LT	1" - 28"	According to pipe	25 bar	Raised Face	ASTM D4024 - Drilling acc. B16.5/B16.47 CL300	FRP - Bisphenol A Epoxy resins reinforced with fiberglass type E or E-CR. Suitable for 90°C.
	Backing Flange	F-25-YV					Drilling acc. B16.5/B16.47 CL300	
<b>Gasket</b>	Flat type	J-300-P3	1" - 28"	-	Class 300	Raised Face	ASME B16.21	Neoprene
<b>Stud &amp; Nuts</b>	Stud and Nuts	P-300-07	1/2" - 1 5/8"	-	-	-	ASME B1.1	A194 Gr 2H, Zn-Ni
								A193 B7, Zn-Ni
<b>Bolt</b>	2 x Hex Bolt	H-300-01	1/2" - 1 7/8"	According to pipe	-	-	ASME B1.1	ASTM A193 Gr B7
<b>Paddles</b>	Figure-8 Blank	RA-300-RP	1" - 10"	According to pipe	300	Raised Face ASME B16.5	ASME B16.48	Carbon Steel ASTM A516 GR60 epoxy coated
	Paddle Blank	RA-300-RP	12" - 28"					
	Paddle Spacer	RE-300-RP						



 <b>PETROBRAS</b>		<b>OFFSHORE PRODUCTION FACILITIES ENGINEERING GUIDELINES</b>				Doc: I-ET-3010.2Q-1200-200-P4X-001	Revision: Rev 0	Sheet 1 of 2
		<b>OFFSHORE PRODUCTION FACILITIES ENGINEERING GUIDELINES</b>					Issued by: SRGE/ESUP	Code: ASME B31.3

Services (see notes): <b>W</b> - De-Aerated Sea Water Injection; <b>PC</b> - Process (Corrosive Hydrocarbon); <b>PCW</b> - Produced water;	Material: <b>CS Inconel Clad.</b>	Class: <b>300</b>	Standard: <b>C30</b>
---	--------------------------------------	----------------------	-------------------------



Pressure Rating (see notes)										
Temperature (°C)	-20	0	38	50	100	150	200			
Max Pressure (barg)	51.1	51.1	51.1	50.1	46.6	45.1	43.8			

**Pipes and Fittings (see notes)**

Items	Code	Size	Wall	Class	Ends	Standard	Material				
Pipes	T-203	1/2" - 1 1/2"	S-40S	-	PE	ASME B36.10/B36.19	ASTM B444 Gr 1 (UNS N06625) SML				
		2" - 3"									
		T-102	4" - 6"					STD	BE	ASME B36.10	API 5L Gr B PSL 1 (SML or WLD HFW or WLD SAW)
			8"					S-20			
			10"					0.279"			
			12"					0.312"			
	14"		0.344"								
	16"		0.406"								
	18"	S-30	API 5L Gr B PSL 1 WLD (HFW or SAW)								
	20"	XS									
	24"	0.625"									
	26"	S-30									
28"	S-30	API 5L Gr B PSL 1 WLD SAW									
30"	0.688"										
Fittings	90 Elbow	C01-33	-	3000	SW	ASME B16.11	ASTM B366 (UNS N06625)				
	45 Elbow	C02-33									
	Tee	C03-33									
	Cross	C05-33									
	Coupling	C06-33									
	Cap	C11-33									
	Socket	C55-33									
	Red Tee	C04-33									
	Red Coupling	C08-33									
	Weldolet	C12-33									
	90 LR Elbow	C15-33									
	45 LR Elbow	C16-33									
	90 SR Elbow	C17-33	2" - 3"	-	BE	ASME B16.9	ASTM A105				
	Tee	C20-33									
	Cap	C22-33									
	Cross	C24-33									
	Weldolet	C12-02									
	Conc. Red	C18-33									
	Ecc. Red	C19-33	3" - 4"	According to pipe	-	ASME B16.9	ASTM B366 (UNS N06625)				
	Red Tee	C21-33									
	90 LR Elbow	C15-03									
	45 LR Elbow	C16-03									
	90 SR Elbow	C17-03									
	Tee	C20-03									
Cap	C22-03	4" - 30"	-	BE	ASME B16.9	ASTM A234 Gr WPB					
Cross	C24-03										
Conc. Red	C18-03										
Ecc. Red	C19-03										
Red Tee	C21-03										
Red Tee	C21-03										
Nipple	Straight Nipple	N-S139	According to pipe	-	PBE	ASTM A733	ASTM B444 Gr 1 (UNS N06625)				
	Swage Conc Nipple	N-C133						3/4" - 1 1/2"			
		N-C433						2" - 4"			
	Swage Ecc Nipple	N-E133						3/4" - 1 1/2"			
		N-E433						2" - 4"			
Flanges	Socket Weld (SW)	F-300-JL	According to pipe	Class 300	Raised Face	ASME B16.5	ASTM B564 (UNS N06625)				
	Welding Neck (WN)	F-300-KL						2" - 3"			
		F-300-KB						4" - 30"			
		F-300-LL						1/2" - 3"			
	Blind	F-300-LB						4" - 30"			
		F-300-LB						4" - 30"			
Gasket	Spiral-Wound	J-300-EM	-	Class 300	Raised Face	ASME B16.20	Inconel/graphite				
Stud & Nuts	Stud and Nuts	P-300-07	1/2" - 1 3/8"	-	-	ASME B1.1	A194 Gr 2H, Zn-Ni				
							A193 B7, Zn-Ni				
Bolt	2 x Hex Bolt	H-300-01	1/2" - 1 3/8"	According to pipe	-	ASME B1.1	ASTM A193 Gr B7				
		Figure-8 Blank	R8-300-RI	1/2" - 10"							
Paddles	Paddle Blank	RA-300-RI	12" - 30"	According to pipe	300	Raised Face ASME B16.5	ASME B16.48	Carbon Steel ASTM A516 GR60 with Inconel 625 layer			
		Paddle Spacer	RE-300-RI	12" - 30"							





		OFFSHORE PRODUCTION FACILITIES ENGINEERING GUIDELINES	Doc: I-ET-3010.2Q-1200-200-P4X-001	Revision: Rev 0	Sheet 1 of 2
		OFFSHORE PRODUCTION FACILITIES ENGINEERING GUIDELINES			Issued by: SRGE/ESUP



Services (see notes): <b>AM</b> - Amine; <b>CNI</b> - Corrosive Chemical Injection (Except Sodium Hypochlorite and DBNPA); <b>FG</b> - Fuel Gas; <b>G</b> - Glycol; <b>H</b> - Hydraulic Fluid; <b>P</b> - Process (non-corrosive hydrocarbon); <b>PC</b> - Process (Corrosive Hydrocarbon);	Material: <b>SS 316/316L</b>	Class: <b>600</b>	Standard: <b>E3</b>
--	---------------------------------	----------------------	------------------------

Pressure Rating (see notes)										
Temperature (°C)	-100	38	50	100	150	200				
Max Pressure (barg)	99.3	99.3	96.2	84.4	77.0	71.3				

**Pipes and Fittings (see notes)**

Items	Code	Size	Wall	Class	Ends	Standard	Material					
Pipes	T-322	½" - 1 ½"	S-40S	-	PE	ASME B36.19	ASTM A312 TP 316/316L SML					
		2" - 8"			BE	ASME B36.10/B36.19	ASTM A358 Type 316/316L Cl 1 or 3 WLD					
		10" - 12"						S-80S				
	14"	0.562"										
	16"	0.625"										
	18"	0.688"										
	20"	0.750"										
	24"	0.875"										
	26"	0.938"										
	28"	1.000"										
30"	1.062"											
32"	1.188"											
Fittings	90 Elbow	C01-43	-	3000	SW	ASME B16.11	ASTM A182 Gr F316/316L					
	45 Elbow	C02-43										
	Tee	C03-43										
	Cross	C05-43										
	Coupling	C06-43										
	Cap	C11-43										
	Socketlet	C55-43										
	Red Tee	C04-43										
	Red Coupling	C08-43										
	Weldolet	C12-43										
	90 LR Elbow	C15-44						According to pipe	-	BE	ASME B16.9	ASTM A403 Gr WP316/316L
	45 LR Elbow	C16-44										
	90 SR Elbow	C17-44										
	Tee	C20-44										
	Cap	C22-44										
	Cross	C24-44										
	Conc. Red	C18-44						3" - 32"	-	-	-	-
	Ecc. Red	C19-44										
Red Tee	C21-44											
Nipple	Straight Nipple	N-S145	According to pipe	-	PBE	ASTM A733	ASTM A312 TP316/316L					
	Swage Conc Nipple	N-C144			¾" - 1 ½"	BLE x PSE	MSS SP-95	ASTM A403 Gr WP316/316L				
		N-C444			2" - 4"	PBE						
	Swage Ecc Nipple	N-E144			¾" - 1 ½"	BLE x PSE						
Flanges	Socket Weld (SW)	F-600-JX	According to pipe	Class 600	Raised Face	ASME B16.5	ASTM A182 Gr F316/316L					
	Welding Neck (WN)	F-600-KX			max 350 bar	-		ISO 6162-1				
	Blind	F-350-4X			½" - 3"	Class 600		Raised Face	-			
		F-600-LX			½" - 32"	max 350 bar		-	ISO 6162-1			
	Hyd One-Piece Flange	F-350-3X			½" - 3"	Class 600		Raised Face	ASME B16.20	AISI 316/graphite		
Gasket	Spiral-Wound	J-600-EH	-	-	-	-	A194 7L, Zn-Ni A320 L7, Zn-Ni					
Stud & Nuts	Stud and Nuts	P-600-08	-	-	-	ASME B1.1						
Paddles	Figure-8 Blank	R8-600-RS	According to pipe	600	Raised Face ASME B16.5	ASME B16.48	Stainless Steel ASTM A240 316					
	Paddle Blank	RA-600-RS										
	Paddle Spacer	RE-600-RS										



		OFFSHORE PRODUCTION FACILITIES ENGINEERING GUIDELINES	Doc: I-ET-3010.2Q-1200-200-P4X-001	Revision: Rev 0	Sheet 1 of 2
		OFFSHORE PRODUCTION FACILITIES ENGINEERING GUIDELINES			Issued by: SRGE/ESUP



Services (see notes): FG- Fuel Gas; G- Glycol; GL- Refrigerated Liquefied Petroleum Gases in Low Temperature; P- Process (non-corrosive hydrocarbon);	Material: Low Temp CS	Class: 600	Standard: E6
--	-----------------------------	---------------	-----------------

Pressure Rating (see notes)										
Temperature (°C)	-46	0	38	50	100	150	180			
Max Pressure (barg)	102.1	102.1	102.1	100.2	93.2	90.2	88.6			

**Pipes and Fittings (see notes)**

Items	Code	Size	Wall	Class	Ends	Standard	Material		
Pipes	T-105	1/2" - 1 1/2"	S-160	-	PE	ASME B36.10	ASTM A333 Gr 6 SML		
		2"	XS						
		3"	STD						
		4"	0.281"						
		6"	0.375"						
		8"	0.438"						
		10"	0.562"						
		12"	0.625"						
	T-106	16" - 24"	S-60	-	BE	ASME B36.10	ASTM A671 Gr CC60 Class 22 WLD		
		26"	1.062"						
Fittings	90 Elbow	C01-04	-	6000	SW	ASME B16.11	ASTM A350 Gr LF2 Cl 1		
	45 Elbow	C02-04							
	Tee	C03-04							
	Cross	C05-04							
	Coupling	C06-04							
	Cap	C11-04							
	Socket	C55-04							
	Red Tee	C04-04							
	Red Coupling	C08-04							
	Weldolet	C12-04			According to pipe	-	BE	ASME B16.9	ASTM A420 Gr WPL6
	90 LR Elbow	C15-05							
	45 LR Elbow	C16-05							
	90 SR Elbow	C17-05							
	Tee	C20-05							
	Cap	C22-05							
	Cross	C24-05							
Conc. Red	C18-05								
Ecc. Red	C19-05								
Red Tee	C21-05								
Nipple	Straight Nipple	N-S137	According to pipe	-	PBE	ASTM A733	ASTM A333 Gr 6		
	Swage Conc Nipple	N-C105			3/4" - 1 1/2"	BLE x PSE	MSS SP-95	ASTM A420 Gr WPL6	
		N-C405			2" - 3"				
	Swage Ecc Nipple	N-E105			3/4" - 1 1/2"	2" - 3"	BLE x PSE	MSS SP-95	ASTM A420 Gr WPL6
		N-E405			2" - 3"				
Flanges	Socket Weld (SW)	F-600-J3	According to pipe	Class 600	Raised Face	ASME B16.5	ASTM A350 Gr LF2 Class 1		
	Welding Neck (WN)	F-600-K3			-				
	Blind	F-600-L3			-				
Gasket	Spiral-Wound	J-600-EH	-	Class 600	Raised Face	ASME B16.20	AISI 316/graphite		
Stud & Nuts	Stud and Nuts	P-600-08	-	-	-	ASME B1.1	A194 7L, Zn-Ni		
						ASME B1.1	A320 L7, Zn-Ni		
Paddles	Figure-8 Blank	R8-600-RL	According to pipe	600	Raised Face ASME B16.5	ASME B16.48	Low Temp. Carbon Steel ASTM A516 70 + S5		
	Paddle Blank	RA-600-RL							
	Paddle Spacer	RE-600-RL							



		OFFSHORE PRODUCTION FACILITIES ENGINEERING GUIDELINES	Doc: I-ET-3010.2Q-1200-200-P4X-001	Revision: Rev 0	Sheet 1 of 2
		OFFSHORE PRODUCTION FACILITIES ENGINEERING GUIDELINES			Issued by: SRGE/ESUP



Services (see notes): DO- Carbon Dioxide (DRY);	Material: Galv. CS	Class: 600	Standard: E8
--	-----------------------	---------------	-----------------

Pressure Rating (see notes)										
Temperature (°C)	-18	0	38	54						
Max Pressure (barg)	102.1	102.1	102.1	99.6						

**Pipes and Fittings (see notes)**

Items		Code	Size	Wall	Class	Ends	Standard	Material		
Pipes	Pipe	T-102	1/2" - 1 1/2"	XS	-	PE	ASME B36.10	API 5L Gr B PSL 1 SML		
			2" - 4"	STD		BE		API 5L Gr B PSL 1 (SML or WLD HFV or WLD SAW)		
			6"	0.312"						
			8"	S-60						
Fittings	90 Elbow	C01-02	1/2" - 1 1/2"	-	3000	SW	ASME B16.11	ASTM A105		
	45 Elbow	C02-02								
	Tee	C03-02								
	Cross	C05-02								
	Coupling	C06-02								
	Union	C10-02								
	Cap	C11-02								
	Socket	C55-02	3/4" - 1 1/2"	-	-	-	ASME B16.11	ASTM A234 Gr WPB		
	Red Tee	C04-02								
	Red Coupling	C08-02								
	Weldolet	C12-02	1" - 3"	According to pipe	-	BE	MSS SP-97	ASTM A234 Gr WPB		
	90 LR Elbow	C15-03	2" - 8"				-		-	ASME B16.9
	45 LR Elbow	C16-03								
	90 SR Elbow	C17-03								
	Tee	C20-03								
	Cap	C22-03								
	Cross	C24-03								
	Conc. Red	C18-03								
Ecc. Red	C19-03	3" - 8"	-				-		-	
Red Tee	C21-03									
Nipple	Straight Nipple	N-S120	1/2" - 1 1/2"	According to pipe	-	PBE	ASTM A733	API 5L Gr B PSL 1 seamless		
	Swage Conc Nipple	N-C103	3/4" - 1 1/2"			BLE x PSE	MSS SP-95	ASTM A234 Gr WPB		
		N-C403	2" - 4"							
	Swage Ecc Nipple	N-E103	3/4" - 1 1/2"			2" - 4"	PBE	-	-	
N-E403		2" - 4"								
Flanges	Welding Neck (WN)	F-600-K2	1/2" - 8"	According to pipe	Class 600	Raised Face	-	ASTM A105		
	Blind	F-600-L2								
Gasket	Spiral-Wound	J-600-EH	1/2" - 8"	-	Class 600	Raised Face	ASME B16.20	AISI 316/graphite		
Stud & Nuts	Stud and Nuts	P-600-07	1/2" - 1 1/8"	-	-	-	ASME B1.1	A194 Gr 2H, Zn-Ni		
								A193 B7, Zn-Ni		
Paddles	Figure-8 Blank	R8-600-RC	1/2" - 8"	According to pipe	600	Raised Face ASME B16.5	ASME B16.48	Carbon Steel ASTM A516 GR60		



 <b>PETROBRAS</b>		<b>OFFSHORE PRODUCTION FACILITIES ENGINEERING GUIDELINES</b>				Doc: I-ET-3010.2Q-1200-200-P4X-001	Revision: Rev 0	Sheet 1 of 2
		<b>OFFSHORE PRODUCTION FACILITIES ENGINEERING GUIDELINES</b>					Issued by: SRGE/ESUP	Code: ASME B31.3

Services (see notes): <b>AM</b> - Amine; <b>PC</b> - Process (Corrosive Hydrocarbon);	Material: <b>Duplex</b>	Class: <b>600</b>	Standard: <b>E16</b>
--	----------------------------	----------------------	-------------------------



Pressure Rating (see notes)										
Temperature (°C)	-46	0	38	50	100	130				
Max Pressure (barg)	103.4	103.4	103.4	103.4	101.3	95.6				

**Pipes and Fittings (see notes)**

Items	Code	Size	Wall	Class	Ends	Standard	Material	
<b>Pipes</b>	T-301	1/2" - 1 1/2"	S-40S	-	PE	ASME B36.10/B36.19	ASTM A790 (UNS S31803) SML	
		2" - 8"			BE		ASTM A928 (UNS S31803 Cl 1 or 3) WLD	
	T-302	10" - 12"	S-80S					
	14" - 16"	0.562"						
<b>Fittings</b>	90 Elbow	C01-27	1/2" - 1 1/2"	-	3000	SW	ASME B16.11	ASTM A182 Gr F51 (UNS S31803)
	45 Elbow	C02-27						
	Tee	C03-27						
	Cross	C05-27						
	Coupling	C06-27						
	Cap	C11-27						
	Socket	C55-27						
	Red Tee	C04-27	3/4" - 1 1/2"	-	-	-	ASME B16.11	-
	Red Coupling	C08-27						
	Weldolet	C12-27	2" - 8"	According to pipe	-	BE	ASME B16.9	ASTM A815 (UNS S31803)
	90 LR Elbow	C15-29	2" - 18"					
	45 LR Elbow	C16-29						
	90 SR Elbow	C17-29						
	Tee	C20-29						
	Cap	C22-29						
	Cross	C24-29	3" - 18"					
	Conc. Red	C18-29						
	Ecc. Red	C19-29						
Red Tee	C21-29							
<b>Nipple</b>	Straight Nipple	N-S128	1/2" - 1 1/2"	According to pipe	-	PBE	ASTM A733	ASTM A790 (UNS S31803)
	Swage Conc Nipple	N-C129	3/4" - 1 1/2"			BLE x PSE	MSS SP-95	ASTM A815 (UNS S31803)
		N-C429	2" - 4"					
	Swage Ecc Nipple	N-E129	3/4" - 1 1/2"			2" - 4"	PBE	
N-E429		2" - 4"	BLE x PSE					
<b>Flanges</b>	Socket Weld (SW)	F-600-JG	1/2" - 1 1/2"	According to pipe	Class 600	Raised Face	ASME B16.5	ASTM A182 Gr F51
	Welding Neck (WN)	F-600-KG	2" - 18"			-		
	Blind	F-600-LG	1/2" - 18"					
<b>Gasket</b>	Spiral-Wound	J-600-EL	1/2" - 18"	-	Class 600	Raised Face	ASME B16.20	Duplex/graphite
<b>Stud &amp; Nuts</b>	Stud and Nuts	P-600-08	1/2" - 1 1/2"	-	-	-	ASME B1.1	A194 7L, Zn-Ni A320 L7, Zn-Ni
	Figure-8 Blank	R8-600-RD	1/2" - 8"	According to pipe	600	Raised Face ASME B16.5	ASME B16.48	Duplex Stainless Steel ASTM A240 UNS31803
Paddle Blank	RA-600-RD	10" - 18"						
Paddle Spacer	RE-600-RD							





 <b>PETROBRAS</b>		<b>OFFSHORE PRODUCTION FACILITIES ENGINEERING GUIDELINES</b>				Doc: I-ET-3010.2Q-1200-200-P4X-001	Revision: Rev 0	Sheet 1 of 2
		<b>OFFSHORE PRODUCTION FACILITIES ENGINEERING GUIDELINES</b>					Issued by: SRGE/ESUP	Code: ASME B31.3



Services (see notes): <p style="text-align: center;"><b>FC</b> - Process (Corrosive Hydrocarbon);</p>	Material: <b>Low Temp CS</b>	Class: <b>600</b>	Standard: <b>E19</b>
--	---------------------------------	----------------------	-------------------------

<b>Pressure Rating (see notes)</b>											
<b>Temperature (°C)</b>	-46	0	38	50	100	150	200	250	300	325	
<b>Max Pressure (barg)</b>	102.1	102.1	102.1	100.2	93.2	90.2	87.6	83.9	79.6	77.4	

**Pipes and Fittings (see notes)**

Items	Code	Size	Wall	Class	Ends	Standard	Material			
<b>Pipes</b>	T-105	1/2" - 1 1/2"	S-160	-	PE	ASME B36.10	ASTM A333 Gr 6 SML			
		2"	0.250"		BE					
		3" - 8"	XS							
		10" - 14"	S-80							
	T-106	16"	0.750"		-			BE	ASME B36.10	ASTM A671 Gr CC60 Class 22 WLD
		18"	0.812"							
		20"	0.875"							
24"	1.000"									
<b>Fittings</b>	90 Elbow	C01-04	1/2" - 1 1/2"	-	6000	SW	ASME B16.11	ASTM A350 Gr LF2 Cl 1		
	45 Elbow	C02-04								
	Tee	C03-04								
	Cross	C05-04								
	Coupling	C06-04								
	Cap	C11-04								
	Socket	C55-04								
	Red Tee	C04-04	3/4" - 1 1/2"	-	6000	SW	ASME B16.11	ASTM A350 Gr LF2 Cl 1		
	Red Coupling	C08-04								
	Weldolet	C12-04								
	90 LR Elbow	C15-05	2" - 24"	-	-	BE	ASME B16.9	ASTM A420 Gr WPL6		
	45 LR Elbow	C16-05								
	90 SR Elbow	C17-05								
	Tee	C20-05								
	Cap	C22-05								
	Cross	C24-05								
	Conc. Red	C18-05								
Ecc. Red	C19-05	3" - 24"	-	-	BE	ASME B16.9	ASTM A420 Gr WPL6			
Red Tee	C21-05									
<b>Nipple</b>	Straight Nipple	N-S137	1/2" - 1 1/2"	According to pipe	-	PBE	ASTM A733	ASTM A333 Gr 6		
	Swage Conc Nipple	N-C105	3/4" - 1 1/2"			BLE x PSE	MSS SP-95	ASTM A420 Gr WPL6		
	Swage Ecc Nipple	N-E105	3/4" - 1 1/2"			PBE				
		N-E405	2" - 4"			BLE x PSE				
<b>Flanges</b>	Socket Weld (SW)	F-600-J3	1/2" - 1 1/2"	According to pipe	Class 600	Raised Face	ASME B16.5	ASTM A350 Gr LF2 Class 1		
	Welding Neck (WN)	F-600-K3	2" - 24"			-				
	Blind	F-600-L3	1/2" - 24"			-				
<b>Gasket</b>	Spiral-Wound	J-600-EH	1/2" - 24"	-	Class 600	Raised Face	ASME B16.20	AISI 316/graphite		
<b>Stud &amp; Nuts</b>	Stud and Nuts	P-600-02	1/2" - 1 7/8"	-	-	-	ASME B1.1	A194 7L		
								A320 L7		
<b>Paddles</b>	Figure-8 Blank	R8-600-RL	1/2" - 8"	According to pipe	600	Raised Face ASME B16.5	ASME B16.48	Low Temp. Carbon Steel ASTM A516 70 + S5		
	Paddle Blank	RA-600-RL	10" - 24"							
	Paddle Spacer	RE-600-RL	1/2" - 24"							



 <b>PETROBRAS</b>		OFFSHORE PRODUCTION FACILITIES ENGINEERING GUIDELINES				Doc: I-ET-3010.2Q-1200-200-P4X-001	Revision: Rev 0	Sheet 1 of 2
		OFFSHORE PRODUCTION FACILITIES ENGINEERING GUIDELINES					Issued by: SRGE/ESUP	Code: ASME B31.3



Services (see notes): <b>FC</b> - Process (Corrosive Hydrocarbon);	Material: <b>CS Inconel Clad.</b>	Class: <b>600</b>	Standard: <b>E30</b>
---	--------------------------------------	----------------------	-------------------------

Pressure Rating (see notes)										
Temperature (°C)	-20	0	38	100	150	200				
Max Pressure (barg)	102.1	102.1	102.1	93.2	90.2	87.6				

**Pipes and Fittings (see notes)**

Items	Code	Size	Wall	Class	Ends	Standard	Material	
Pipes	T-203	1/2" - 1 1/2"	S-40S	-	PE	ASME B36.10/B36.19	ASTM B444 Gr 1 (UNS N06625) SML	
		2" - 3"			BE			
		4" - 10"						ASME B36.10
	T-107	12" - 14"	API 5L Gr X65 PSL 2 (SML or WLD SAW)					
		16"			API 5L Gr X65 PSL 2 WLD SAW			
		18"						
		20"						
24"								
Fittings	C01-33	1/2" - 1 1/2"	-	3000	SW	ASME B16.11	ASTM B366 (UNS N06625)	
	C02-33							
	C03-33							
	C05-33							
	C06-33							
	C11-33							
	C55-33							
	C04-33	3/4" - 1 1/2"	-	3000	SW	ASME B16.11	ASTM B366 (UNS N06625)	
	C08-33							
	C15-33	2" - 3"	-	3000	SW	ASME B16.9	ASTM B366 (UNS N06625)	
	C16-33							
	C17-33							
	C20-33							
	C22-33							
	C24-33							
	C12-33							2" - 4"
	C12-22							
	C18-33	2" - 10"	-	3000	SW	ASME B16.9	ASTM A694 Gr F65	
	C19-33							
	C21-33	3" - 4"	According to pipe	-	3000	BE	ASME B16.9	ASTM B366 (UNS N06625)
	C15-22							
	C16-22							
	C17-22							
	C20-22							
	C22-22							
	C24-22							
	C18-22	4" - 24"	-	3000	BE	MSS SP-75	ASTM A860 WPHY65	
	C19-22							
C21-22								
Nipple	N-S139	1/2" - 1 1/2"	According to pipe	-	-	PBE	ASTM A733	
	N-C133	3/4" - 1 1/2"						
	N-E133	2" - 3"						
	N-E433	3/4" - 1 1/2"						
	N-E433	2" - 3"						
Flanges	F-600-JL	1/2" - 1 1/2"	According to pipe	Class 600	-	Raised Face	ASME B16.5	
	F-600-KL	2" - 3"						
	F-600-KC	4" - 24"						
	F-600-LL	1/2" - 3"						
	F-600-LC	4" - 24"						
Gasket	J-600-EM	1/2" - 24"	-	Class 600	-	Raised Face	ASME B16.20	
	Stud & Nuts	P-600-08	1/2" - 1 1/8"	-	-	-	ASME B1.1	
Inconel/graphite								
Paddles	R8-600-RI	1/2" - 8"	According to pipe	600	-	Raised Face ASME B16.5	ASME B16.48	
	RA-600-RI	10" - 24"						Carbon Steel ASTM A516 GR60 with Inconel 625 layer
	RE-600-RI							



 <b>PETROBRAS</b>		OFFSHORE PRODUCTION FACILITIES ENGINEERING GUIDELINES				Doc: I-ET-3010.2Q-1200-200-P4X-001	Revision: Rev 0	Sheet 1 of 2
		OFFSHORE PRODUCTION FACILITIES ENGINEERING GUIDELINES						Issued by: SRGE/ESUP



Services (see notes): <b>S- Steam;</b>	Material: <b>P22 Alloy Steel</b>	Class: <b>600</b>	Standard: <b>E34</b>
---	-------------------------------------	----------------------	-------------------------

Pressure Rating (see notes)										
Temperature (°C)	-20	0	38	50	100	150	200	210		
Max Pressure (barg)	102.1	102.1	102.1	100.2	93.2	90.2	87.6	86.8		

**Pipes and Fittings (see notes)**

Items	Code	Size	Wall	Class	Ends	Standard	Material			
Pipes	T-102	1/2" - 1 1/2"	S-160	-	PE	ASME B36.10	API 5L Gr B PSL 1 SML			
		2" - 4"	STD		BE		API 5L Gr X65 PSL 2 (SML or WLD SAW)			
	T-107	6"	0.312"							
		8"	0.375"							
		10"	0.438"							
		12"	XS							
		14"	0.562"							
		16"	0.625"							
		18"	0.688"							
		20"	0.750"							
24"	0.875"	API 5L Gr X65 PSL 2 WLD SAW								
Fittings	90 Elbow	C01-02	-	6000	SW	ASME B16.11	ASTM A105			
	45 Elbow	C02-02								
	Tee	C03-02								
	Cross	C05-02								
	Coupling	C06-02								
	Cap	C11-02								
	Sockolet	C55-02								
	Red Tee	C04-02								
	Red Coupling	C08-02								
	2" - 24"	Weldolet			C12-22	According to pipe	-	BE	MSS SP-97	ASTM A694 Gr F65
		90 LR Elbow			C15-22					
		45 LR Elbow			C16-22					
		90 SR Elbow			C17-22					
		Tee			C20-22					
		Cap			C22-22					
		Cross			C24-22					
Conc. Red		C18-22								
Ecc. Red	C19-22									
Red Tee	C21-22									
Nipple	Straight Nipple	N-S120	According to pipe	-	PBE	ASTM A733	API 5L Gr B PSL 1 seamless			
	Swage Conc Nipple	N-C103			3/4" - 1 1/2"	BLE x PSE	MSS SP-95	ASTM A234 Gr WPB		
		N-C422			2" - 4"			ASTM A860 WPHY65		
	Swage Ecc Nipple	N-E103			3/4" - 1 1/2"	2" - 4"	PBE	ASTM A234 Gr WPB	ASTM A860 WPHY65	
		N-E422			2" - 4"		BLE x PSE		ASTM A860 WPHY65	
Flanges	Socket Weld (SW)	F-600-J2	According to pipe	Class 600	Raised Face	ASME B16.5	ASTM A105			
	Welding Neck (WN)	F-600-KC				-	ASTM A694 Gr F65			
	Blind	F-600-L2					1/2" - 1 1/2"	ASTM A105		
		F-600-LC				2" - 24"	ASTM A694 Gr F65			
Gasket	Spiral-Wound	J-600-EH	-	Class 600	Raised Face	ASME B16.20	AISI 316/graphite			
Stud & Nuts	Stud and Nuts	P-600-08	-	-	-	ASME B1.1	A194 7L, Zn-Ni			
							A320 L7, Zn-Ni			
Paddles	Figure-8 Blank	R8-600-RC	According to pipe	600	Raised Face ASME B16.5	ASME B16.48	Carbon Steel ASTM A516 GR60			
	Paddle Blank	RA-600-RC								
	Paddle Spacer	RE-600-RC								



		OFFSHORE PRODUCTION FACILITIES ENGINEERING GUIDELINES	Doc: I-ET-3010.2Q-1200-200-P4X-001	Revision: Rev 0	Sheet 1 of 2
		OFFSHORE PRODUCTION FACILITIES ENGINEERING GUIDELINES			Issued by: SRGE/ESUP

Services (see notes): <b>CL</b> - Refrigerated Liquefied Petroleum Gases in Low Temperature; <b>P</b> - Process (non-corrosive hydrocarbon);	Material: <b>Low Temp CS</b>	Class: <b>900</b>	Standard: <b>F6</b>
---	---------------------------------	----------------------	------------------------



Pressure Rating (see notes)											
Temperature (°C)	-46	0	38	50	100	200	250	300	320		
Max Pressure (barg)	153.2	153.2	153.2	150.4	139.8	131.4	125.8	119.5	116.7		

**Pipes and Fittings (see notes)**

Items	Code	Size	Wall	Class	Ends	Standard	Material					
Pipes	T-105	1/2" - 1 1/2"	S-160	-	PE	ASME B36.10	ASTM A333 Gr 6 SML					
		2" - 3"	XS		BE							
		4"	S-120									
		6"	0.500"									
		8"	0.625"									
		10"	0.812"									
		12"	0.875"									
	T-106	14"	S-100									
		16"	0.938"		ASTM A671 Gr CC60 Class 22 WLD							
		18"	1.062"									
20"	1.188"											
Fittings	90 Elbow	C01-04	-	6000	SW	ASME B16.11	ASTM A350 Gr LF2 Cl 1					
	45 Elbow	C02-04										
	Tee	C03-04										
	Cross	C05-04										
	Coupling	C06-04										
	Cap	C11-04										
	Sockolet	C55-04										
	Red Tee	C04-04										
	Red Coupling	C08-04										
	Weldolet	C12-04										
	90 LR Elbow	C15-05						According to pipe	-	BE	ASME B16.9	ASTM A420 Gr WPL6
	45 LR Elbow	C16-05										
	90 SR Elbow	C17-05										
	Tee	C20-05										
	Cap	C22-05										
	Cross	C24-05										
Conc. Red	C18-05											
Ecc. Red	C19-05											
Red Tee	C21-05											
Nipple	Straight Nipple	N-S137	1/2" - 1 1/2"	-	PBE	ASTM A733	ASTM A333 Gr 6					
	Swage Conc Nipple	N-C105	3/4" - 1 1/2"									
		N-C405	2" - 4"									
	Swage Ecc Nipple	N-E105	3/4" - 1 1/2"									
		N-E405	2" - 4"									
Flanges	Socket Weld (SW)	F-1500-Q3	1/2" - 1 1/2"	According to pipe	Class 1500	ASME B16.5	ASTM A350 Gr LF2 Class 1					
	Welding Neck (WN)	F-1500-R3	2"									
		F-900-R3	3" - 20"									
	Blind	F-1500-S3	1/2" - 2"									
		F-900-S3	3" - 20"									
Gasket	Ring-Joint	J-1500-AT	1/2" - 2"	-	Class 1500	ASME B16.20	Stainless Steel AISI 316					
		J-900-AT	3" - 20"					Class 900				
Stud & Nuts	Stud and Nuts	P-900-02	3/4" - 2"	-	-	ASME B1.1	A194 7L A320 L7					
	Paddles	Figure-8 Blank	R8-900-JL	1/2" - 6"	According to pipe	900	Ring Type Joint ASME B16.5	ASME B16.48				
Paddle Blank		RA-900-JL	8" - 20"	Low Temp. Carbon Steel ASTM A516 70 + S5								
Paddle Spacer		RE-900-JL										





 <b>PETROBRAS</b>		OFFSHORE PRODUCTION FACILITIES ENGINEERING GUIDELINES				Doc: I-ET-3010.2Q-1200-200-P4X-001	Revision: Rev 0	Sheet 1 of 2
		OFFSHORE PRODUCTION FACILITIES ENGINEERING GUIDELINES						Issued by: SRGE/ESUP

Services (see notes): <b>CNI</b> - Corrosive Chemical Injection (Except Sodium Hypochlorite and DBNPA); <b>FG</b> - Fuel Gas; <b>G</b> - Glycol; <b>H</b> - Hydraulic Fluid; <b>IA</b> - Instrumentation Air; <b>P</b> - Process (non-corrosive hydrocarbon); <b>PC</b> - Process (Corrosive Hydrocarbon);	Material: <b>SS 316/316L</b>	Class: <b>1500</b>	Standard: <b>G3</b>
---	---------------------------------	-----------------------	------------------------

Pressure Rating (see notes)										
Temperature (°C)	-100	38	50	100	150	210				
Max Pressure (barg)	248.2	248.2	240.6	211	192.5	176.0				

**Pipes and Fittings (see notes)**

Items	Code	Size	Wall	Class	Ends	Standard	Material						
Pipes	T-322	1/2" - 1 1/2"	S-80S	-	PE	ASME B36.19	ASTM A312 TP 316/316L SML						
		2"			BE	ASME B36.10/B36.19	ASTM A358 Type 316/316L Cl 1 or 3 WLD						
		3" - 4"						0.438"					
	6"	0.719"											
	8"	0.875"											
	10"	1.125"											
	12"	1.250"											
	T-323	14"	1.406"										
		16"	1.594"										
18"		1.781"											
20"		1.969"											
Fittings		90 Elbow	C01-43	-	3000	SW	ASME B16.11	ASTM A182 Gr F316/316L					
		45 Elbow	C02-43										
		Tee	C03-43										
	Cross	C05-43											
	Coupling	C06-43											
	Cap	C11-43											
	Sockolet	C55-43											
	Red Tee	C04-43											
	Red Coupling	C08-43											
	Weldolet	C12-43	1" - 8"						According to pipe	-	ASME B16.9	ASTM A403 Gr WP316/316L	
	90 LR Elbow	C15-44	2" - 20"										
	45 LR Elbow	C16-44											
	90 SR Elbow	C17-44											
	Tee	C20-44											
	Cap	C22-44											
Cross	C24-44												
Conc. Red	C18-44	3" - 20"											
Ecc. Red	C19-44												
Red Tee	C21-44												
Nipple	Straight Nipple	N-S145	1/2" - 1 1/2"	-	PBE	ASTM A733	ASTM A312 TP316/316L						
	Swage Conc Nipple	N-C144	3/4" - 1 1/2"			According to pipe	-	MSS SP-95					ASTM A403 Gr WP316/316L
		N-C444	2" - 4"										
	Swage Ecc Nipple	N-E144	3/4" - 1 1/2"										
		N-E444	2" - 4"										
Flanges	Socket Weld (SW)	F-1500-QX	1/2" - 1 1/2"	-	Class 1500				Ring Type Joint	ASME B16.5			
	Welding Neck (WN)	F-1500-RX	2" - 20"			-	ISO 6162-1	ASTM A182 Gr F316/316L					
	Blind	F-350-4X	1/2" - 3"			-	-						
		F-1500-SX	1/2" - 20"			-	-		ISO 6162-1				
Hyd One-Piece Flange	F-350-3X	1/2" - 3"	-	-	-	-							
Gasket	Ring-Joint	J-1500-AT	1/2" - 20"	-	Class 1500	Ring Type Joint	ASME B16.20	Stainless Steel AISI 316					
Stud & Nuts	Stud and Nuts	P-1500-08	3/4" - 3"	-	-	-	ASME B1.1	A194 7L, Zn-Ni					
							A320 L7, Zn-Ni						
Paddles	Figure-8 Blank	R8-1500-JS	1/2" - 6"	-	1500	Ring Type Joint ASME B16.5	ASME B16.48	Stainless Steel ASTM A240 316					
	Paddle Blank	RA-1500-JS	8" - 20"										
	Paddle Spacer	RE-1500-JS											

### Valves (see notes)

Type	Size	CODE	Temp	Type	Size	CODE	Temp	Type	Size	CODE	Temp	Type	Size	CODE	Temp				
Check	½" - 1 ½"	VRE-1500-1-S202	-100C to 400C	Ball	2" - 20"	VES-1500-1-S270	-100C to 200C	Ball	2" - 20"	VES-1500-3-S228	0C to 150C	Double Ball	½" - 2"	VDE-1500-2-S206	-100C to 200C				
		VRE-1500-2-S202				VES-1500-2-S214	-30C to 150C			VES-1500-3-S229				VDE-1500-2-S2F1	-30C to 150C				
		VRE-1500-2-S212				VES-1500-2-S218				VES-1500-3-S238				VDE-1500-2-S2F2	-46C to 150C				
	VRE-1500-2-S215	VES-1500-2-S21F				-46C to 150C	VES-1500-3-S239			VDE-1500-2-S2F3				-46C to 150C					
	VRE-1500-2-S235	VES-1500-2-S21G					VES-1500-3-S23G			VDE-1500-2-S2F4				-46C to 150C					
Needle	½" - 1 ½"	VAG-5000-1-S201	-100C to 200C			VES-1500-2-S224	0C to 150C			VES-1500-3-S252	-30C to 150C			VDE-1500-2-S2F5	-100C to 200C				
		VAG-5000-1-S202	-100C to 400C			VES-1500-2-S228				VES-1500-3-S253				VDE-1500-2-S2F6	-100C to 200C				
		VAG-5000-1-S2F1	-100C to 200C			VES-1500-2-S234				-46C to 150C				VES-1500-3-S25G	0C to 210C	VGA-1501-1-S201	-46C to 400C		
		VAG-5000-1-S2F2	-100C to 400C			VES-1500-2-S238								VES-1500-3-S262		VGA-1500-1-S231	-29C to 400C		
		Axial On-off	12" - 20"			VAX-1500-3-S2F1				-100C to 150C				VES-1500-2-S23F	-46C to 150C	VES-1500-3-S263	0C to 210C	VGA-1500-2-S231	-46C to 400C
Ball	½" - 1 ½"					VES-1502-1-S206	-30C to 150C			VES-1500-2-S23G	-100C to 200C			Double Ball		3" - 8"		VDE-1500-2-S214	-30C to 150C
						VES-1502-1-S207	-46C to 200C			VES-1500-2-S250								VDE-1500-2-S215	-30C to 150C
						VES-1502-2-S206	-30C to 150C			VES-1500-2-S252								VDE-1500-2-S21F	-30C to 150C
						VES-1502-2-S207	-100C to 200C			VES-1500-2-S25F								VDE-1500-2-S234	-46C to 150C
		VES-1502-2-S2F6	-30C to 150C			VES-1500-2-S25G	VDE-1500-2-S235			-46C to 150C									
		VES-1502-2-S2F7	-100C to 200C	VES-1500-2-S260	VDE-1500-2-S23F	-100C to 200C													
		VES-1502-2-S2FB	-46C to 150C	VES-1500-2-S262	VDE-1500-2-S270	-100C to 200C													
		VES-1502-3-S207	-46C to 200C	VES-1500-2-S270	VDE-1500-2-S27F	-100C to 200C													
		VES-1502-3-S2F7	-46C to 200C	VES-1500-2-S272	VDE-1500-2-S201	-30C to 150C													
		VES-1500-1-S214	-30C to 150C	VES-1500-2-S27F	VDE-1500-2-S202	-30C to 150C													
Ball	2" - 20"	VES-1500-1-S224	0C to 150C	VES-1500-2-S27G	-100C to 200C	Double Ball	½" - 2"	VDE-1500-2-S203	-46C to 150C										
		VES-1500-1-S234	-46C to 150C	VES-1500-2-S27G				VDE-1500-2-S204	-46C to 150C										
		VES-1500-1-S250	-30C to 150C	VES-1500-3-S218				VDE-1500-2-S205	-100C to 200C										
		VES-1500-1-S250	-30C to 150C	VES-1500-3-S219															
		VES-1500-1-S260	0C to 210C	VES-1500-3-S21G															

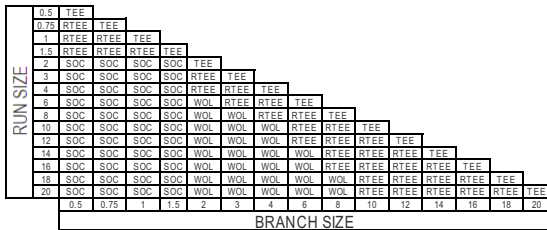

### Branch (see notes)



WOL - Weldolet  
 Tee - Tee  
 RTEE - Red Tee  
 HC - Half Coupling  
 SOC - Socket

### Notes

1	On the spec valve list, it may have valves codes which contain values of process data lower than spec limits. It shall be verified all valve process data (e.g.: pressure, temperature) in order to specify it according the design premisses.
2	See Annex A for valves requirements and general selection criteria.
3	Bolts, nuts and gaskets (only RTJ gaskets) must be Zn-Ni coated according to Annex B.
4	See Annex C for instruments, drains and vents typical piping arrangement.
5	Flanges ≤ 1 1/2" may be used, if strictly necessary.
6	See Annex E for Isolation gasket specifications.
7	Welding and Welding Inspection activities shall follow the requirements of these documents: I-ET-3010.00-1200-955-P4X-001-Welding.
8	All valves, pipes and components specified for hydrogen sulfide service shall be in accordance with ISO 15156 requirements. ASTM A 193 B7 / ASTM A 320 L7 studs with ASME B 16.5, ASME B 16.47 or API 6A flanges are acceptable for sour service fluids.
51	Stainless Steel external coating shall be applied for the temperature limits according to I-ET-3010.00-1200-956-P4X-002 - General Painting.
59	In case of use this spec below -30 °C, the material shall be furnished with solution heat treatment.
120	Wafer valves shall not be used with flammable or combustible services, according to NFPA definition.
125	Materials listed in this spec shall meet the requirements described in the notes and annexes of this document and also the requirements of the specific data sheet in IOGP S-563 as applicable. In case of conflict of criteria Petrobras shall be consulted. It shall be highlighted that the IOGP requirements is not applicable for: inconel 625 coating, which shall follow I-ET-3010.00-1200-955-P4X-001; supplementary NACE requirement for carbon steel which shall follow Annex D; and coating for bolts and nuts shall follow spec note number 3.
127	ISO 6162-1/2 flanges may be used only for H - Hydraulic Fluid.
146	Seamless pipe is acceptable in place of welded pipe. The thickness need to be updated by designer.
156	cancelled

		OFFSHORE PRODUCTION FACILITIES ENGINEERING GUIDELINES	Doc: I-ET-3010.2Q-1200-200-P4X-001	Revision: Rev 0	Sheet 1 of 2
		OFFSHORE PRODUCTION FACILITIES ENGINEERING GUIDELINES			Issued by: SRGE/ESUP



Services (see notes): BG- Inert Gas; CI- Chemical Injection (non-corrosive); G- Glycol; IW- De-Aerated Sea Water Injection; P- Process (non-corrosive hydrocarbon); W- Industrial water;	Material: Carbon Steel	Class: 1500	Standard: G10
---	---------------------------	----------------	------------------

Pressure Rating (see notes)										
Temperature (°C)	-20	0	38	50	100	150	200			
Max Pressure (barg)	255.3	255.3	255.3	250.6	233.0	225.4	219			

**Pipes and Fittings (see notes)**

Items	Code	Size	Wall	Class	Ends	Standard	Material		
Pipes	T-102	1/2" - 1 1/2"	S-160	-	PE	ASME B36.10	API 5L Gr B PSL 1 SML		
		2" - 3"					API 5L Gr X65 PSL 2 (SML or WLD SAW)		
	T-107	4"	BE						
		6"							
		8"							
		10"							
		12"							
		14"							
16" - 24"	S-140	API 5L Gr X65 PSL 2 WLD SAW							
Fittings	90 Elbow	1/2" - 1 1/2"	-	6000	SW	ASME B16.11	ASTM A105		
	45 Elbow								
	Tee								
	Cross								
	Coupling								
	Cap								
	Socket								
	Red Tee	3/4" - 1 1/2"	-	-	-	-	-		
	Red Coupling								
	Weldolet								
	90 LR Elbow	2" - 24"	According to pipe	-	BE	MSS SP-97	ASTM A694 Gr F65		
	45 LR Elbow								
	90 SR Elbow								
	Tee								
	Cap								
	Cross								
	Conc. Red								
	Ecc. Red	3" - 24"	-	-	-	-	-		
Red Tee									
Nipple	Straight Nipple	N-S120	1/2" - 1 1/2"	According to pipe	-	PBE	ASTM A733	API 5L Gr B PSL 1 seamless	
	Swage Conc Nipple	N-C103	3/4" - 1 1/2"			BLE x PSE	MSS SP-95	ASTM A234 Gr WPB	
		N-C422	2" - 4"					ASTM A860 WPHY65	
	Swage Ecc Nipple	N-E103	3/4" - 1 1/2"			PBE	-	-	ASTM A234 Gr WPB
		N-E422	2" - 4"						ASTM A860 WPHY65
Flanges	Socket Weld (SW)	F-1500-Q2	1/2" - 1 1/2"	According to pipe	Class 1500	Ring Type Joint	ASME B16.5	ASTM A105	
	Welding Neck (WN)	F-1500-RC	2" - 24"					ASTM A694 Gr F65	
	Blind	F-1500-S2	1" - 1 1/2"					ASTM A105	
		F-1500-SC	4" - 24"					ASTM A694 Gr F65	
Gasket	Ring-Joint	J-1500-AN	1/2" - 24"	-	Class 1500	Ring Type Joint	ASME B16.20	Carbon Steel	
Stud & Nuts	Stud and Nuts	P-1500-08	3/4" - 3 1/2"	-	-	-	ASME B1.1	A194 7L, Zn-Ni	
								A320 L7, Zn-Ni	
Paddles	Figure-8 Blank	R8-1500-JC	1/2" - 6"	According to pipe	1500	Ring Type Joint ASME B16.5	ASME B16.48	Carbon Steel ASTM A516 GR60	
	Paddle Blank	RA-1500-JC	8" - 24"						
	Paddle Spacer	RE-1500-JC							



 <b>PETROBRAS</b>		<b>OFFSHORE PRODUCTION FACILITIES ENGINEERING GUIDELINES</b>				Doc: I-ET-3010.2Q-1200-200-P4X-001	Revision: Rev 0	Sheet 1 of 2
		<b>OFFSHORE PRODUCTION FACILITIES ENGINEERING GUIDELINES</b>					Issued by: SRGE/ESUP	Code: ASME B31.3



Services (see notes): <p style="text-align: center;"><b>FC</b> - Process (Corrosive Hydrocarbon);</p>	Material: <b>Duplex</b>	Class: <b>1500</b>	Standard: <b>G16</b>
--	----------------------------	-----------------------	-------------------------

Pressure Rating (see notes)										
Temperature (°C)	-46	0	38	50	100	130				
Max Pressure (barg)	258.6	258.6	258.6	258.6	253.3	239				

**Pipes and Fittings (see notes)**

Items	Code	Size	Wall	Class	Ends	Standard	Material				
Pipes	T-301	1/2" - 1 1/2"	S-40S	-	PE	ASME B36.10/B36.19	ASTM A790 (UNS S31803) SML				
		2" - 4"	S-80S								
		6"	0.500"								
		8"	0.594"								
	T-302	10"	0.719"		-		BE	ASME B36.10/B36.19	ASTM A928 (UNS S31803 Cl 1 or 3) WLD		
		12"	0.812"								
		14"	0.875"								
		16"	1.000"								
		18"	1.125"								
		20"	1.250"								
24"	1.500"										
Fittings	90 Elbow	C01-27	-	3000	SW	ASME B16.11	ASTM A182 Gr F51 (UNS S31803)				
	45 Elbow	C02-27									
	Tee	C03-27									
	Cross	C05-27									
	Coupling	C06-27									
	Cap	C11-27									
	Socket	C55-27									
	Red Tee	C04-27									
	Red Coupling	C08-27					3/4" - 1 1/2"	According to pipe	BE	ASME B16.11	ASTM A815 (UNS S31803)
	Weldolet	C12-27					1" - 10"				
	90 LR Elbow	C15-29									
	45 LR Elbow	C16-29									
	90 SR Elbow	C17-29									
	Tee	C20-29									
	Cap	C22-29									
	Cross	C24-29									
Conc. Red	C18-29	3" - 24"	-	BE	ASME B16.9	ASTM A815 (UNS S31803)					
Ecc. Red	C19-29										
Red Tee	C21-29										
Nipple	Straight Nipple	N-S128	1/2" - 1 1/2"	-	PBE	ASTM A733	ASTM A790 (UNS S31803)				
	Swage Conc Nipple	N-C129	3/4" - 1 1/2"								
		N-C429	2" - 4"								
	Swage Ecc Nipple	N-E129	3/4" - 1 1/2"					According to pipe	-	MSS SP-95	ASTM A815 (UNS S31803)
		N-E429	2" - 4"								
Flanges	Socket Weld (SW)	F-1500-QG	1/2" - 1 1/2"	Class 1500	Ring Type Joint	ASME B16.5	ASTM A182 Gr F51				
	Welding Neck (WN)	F-1500-RG	2" - 24"								
	Blind	F-1500-SG	1/2" - 24"								
Gasket	Ring-Joint	J-1500-AT	1/2" - 24"	Class 1500	Ring Type Joint	ASME B16.20	Stainless Steel AISI 316				
Stud & Nuts	Stud and Nuts	P-1500-09	3/4" - 3 1/2"	-	-	ASME B1.1	A194 7L, Zn-Ni				
							A320 L43, Zn-Ni				
Paddles	Figure-8 Blank	R8-1500-JD	1/2" - 6"	According to pipe	1500	Ring Type Joint ASME B16.5	Duplex Stainless Steel ASTM A240 UNS31803				
	Paddle Blank	RA-1500-JD	8" - 24"								
	Paddle Spacer	RE-1500-JD									



		OFFSHORE PRODUCTION FACILITIES ENGINEERING GUIDELINES				Doc: I-ET-3010.2Q-1200-200-P4X-001	Revision: Rev 0	Sheet 1 of 2
		OFFSHORE PRODUCTION FACILITIES ENGINEERING GUIDELINES					Issued by: SRGE/ESUP	Code: ASME B31.3



Services (see notes): <b>FC</b> - Process (Corrosive Hydrocarbon);	Material: <b>Duplex</b>	Class: <b>1500</b>	Standard: <b>G16P</b>
---	----------------------------	-----------------------	--------------------------

Pressure Rating (see notes)										
Temperature (°C)	-46	0	38	50	100	130				
Max Pressure (barg)	258.6	258.6	258.6	258.6	253.3	239.1				

**Pipes and Fittings (see notes)**

Items	Code	Size	Wall	Class	Ends	Standard	Material									
Pipes	T-301	1" - 1 1/2"	S-40S	-	PE	ASME B36.10/B36.19	ASTM A790 (UNS S31803) SML									
		2" - 4"	S-80S		BE											
		6"	0.500"													
		8"	0.594"													
	T-302	10"	0.719"					ASTM A928 (UNS S31803 CI 1 or 3) WLD								
		12"	0.812"													
T-302	14"	0.875"														
	90 Elbow	C01-27	1/2" - 1 1/2"	-	3000	SW	ASTM A182 Gr F51 (UNS S31803)									
45 Elbow	C02-27															
Tee	C03-27															
Cross	C05-27															
Coupling	C06-27															
Cap	C11-27															
Socketlet	C55-27															
Red Tee	C04-27	3/4" - 1 1/2"														
Red Coupling	C08-27															
Weldolet	C12-27	1" - 6"						According to pipe	-	BE	ASTM A815 (UNS S31803)					
90 LR Elbow	C15-29	2" - 3"														
45 LR Elbow	C16-29															
90 SR Elbow	C17-29															
Tee	C20-29		2" - 14"													
Conc. Red	C18-29	3"														
Ecc. Red	C19-29															
Red Tee	C21-29	3" - 14"														
3D 45 Bend	C33-28	4" - 8"	-	-	BE	ASTM A790 (UNS S31803)										
5D 45 Bend	C34-28															
3D 90 Bend	C35-28															
5D 90 Bend	C36-28															
3D 45 Bend	C33-42	10" - 14"					-	-	BE	ASTM A928 (UNS S31803 CI 1 or 3)						
5D 45 Bend	C34-42															
3D 90 Bend	C35-42															
5D 90 Bend	C36-42															
Nipple	Straight Nipple	N-S128									1" - 1 1/2"	According to pipe	-	PBE	ASTM A733	ASTM A790 (UNS S31803)
	Socket Weld (SW)	F-1500-QG									1" - 1 1/2"					
Flanges	Welding Neck (WN)	F-1500-RG	2" - 14"	According to pipe	Class 1500	Ring Type Joint					ASME B16.5	ASTM A182 Gr F51				
	Blind	F-1500-SG	1" - 14"								-					
Gasket	Ring-Joint	J-1500-AT	1" - 14"	-	Class 1500	Ring Type Joint					ASME B16.20	Stainless Steel AISI 316				
Stud & Nuts	Stud and Nuts	P-1500-08	3/4" - 2 1/4"	-	-	-					ASME B1.1	A194 7L, Zn-Ni A320 L7, Zn-Ni				
	Figure-8 Blank	R8-1500-JD	1" - 6"													
Paddles	Paddle Blank	RA-1500-JD	8" - 14"	According to pipe	1500	Ring Type Joint ASME B16.5	ASME B16.48	Duplex Stainless Steel ASTM A240 UNS31803								
	Paddle Spacer	RE-1500-JD														



		OFFSHORE PRODUCTION FACILITIES ENGINEERING GUIDELINES	Doc: I-ET-3010.2Q-1200-200-P4X-001	Revision: Rev 0	Sheet: 2 of 2
		OFFSHORE PRODUCTION FACILITIES ENGINEERING GUIDELINES			Material: Duplex

### Valves (see notes)

Type	Size	CODE	Temp	Type	Size	CODE	Temp	Type	Size	CODE	Temp	Type	Size	CODE	Temp			
Check	1" - 1 1/2"	VRE-1500-1-D202	-46C to 150C	Ball	2" - 14"	VES-1501-3-D2F7	-46C to 150C	Ball	2" - 14"	VES-1500-3-D272	0C to 210C	Double Ball	1" - 2"	VDE-1500-2-D2F3	-46C to 150C			
		VRE-1500-2-D212				VES-1500-2-D214	VES-1500-3-D273			VDE-1500-2-D2F4								
	VRE-1500-2-D215	VES-1500-2-D218	VES-1500-3-D27G			VGA-1501-2-D201	-50C to 150C											
Needle	1" - 1 1/2"	VAG-5000-1-D202	-46C to 150C			VES-1500-2-D21F	-30C to 150C			6" - 14"		VES-1500-4-D264	0C to 150C	Gate	2" - 14"	VGA-1500-1-D231	-50C to 150C	
		VAG-5000-1-D2F2				VES-1500-2-D21G	VES-1500-4-D274					0C to 210C						
Ball	1" - 1 1/2"	VES-1501-1-D206	-30C to 150C			VES-1500-2-D234	0C to 150C			2" - 14"		VES-1500-4-D27U	0C to 210C	Double Ball	1" - 2"	VDE-1500-2-D201	-30C to 150C	Double Ball
		VES-1501-1-D207	-46C to 150C			VES-1500-2-D238		VDE-1500-2-D202	-30C to 150C		VDE-1500-2-D21F	-30C to 150C						
		VES-1501-2-D206	-30C to 150C			VES-1500-2-D23F		VDE-1500-2-D203	-46C to 150C		VDE-1500-2-D234	-46C to 150C						
		VES-1501-2-D207	-46C to 150C			VES-1500-2-D23G		VDE-1500-2-D204	-46C to 150C		VDE-1500-2-D235	-46C to 150C						
		VES-1501-2-D2F6	-30C to 150C			VES-1500-3-D21G	-30C to 150C	VDE-1500-2-D2F1	-30C to 150C	VDE-1500-2-D23F	-46C to 150C							
		VES-1501-2-D2F7	-46C to 150C			VES-1500-3-D252	0C to 150C	VDE-1500-2-D2F2	-30C to 150C	VGL-1500-2-D201	-46C to 150C							
		VES-1501-3-D207	-46C to 150C			VES-1500-3-D253	0C to 150C			VGL-1500-2-D2F1	-46C to 150C							

### Branch (see notes)

RUN SIZE	0.5	TEE																
	0.75	RTEE	TEE															
	1	RTEE	RTEE	TEE														
	1.5	RTEE	RTEE	RTEE	TEE													
	2	SOC	SOC	SOC	SOC	TEE												
	3	SOC	SOC	SOC	SOC	RTEE	TEE											
	4	SOC	SOC	SOC	SOC	RTEE	RTEE	TEE										
	6	SOC	SOC	SOC	SOC	WOL	RTEE	RTEE	TEE									
	8	SOC	SOC	SOC	SOC	WOL	WOL	RTEE	RTEE	TEE								
	10	SOC	SOC	SOC	SOC	WOL	WOL	WOL	RTEE	RTEE	TEE							
	12	SOC	SOC	SOC	SOC	WOL	WOL	WOL	RTEE	RTEE	RTEE	TEE						
	14	SOC	SOC	SOC	SOC	WOL	WOL	WOL	WOL	RTEE	RTEE	RTEE	TEE					
	0.5	0.75	1	1.5	2	3	4	6	8	10	12	14						
	BRANCH SIZE																	

WOL - Weldolet

TEE - Tee



RTEE - Red Tee

HC - Half Coupling

SOC - Sockolet

### Notes

1	On the spec valve list, it may have valves codes which contain values of process data lower than spec limits. It shall be verified all valve process data (e.g.: pressure, temperature) in order to specify it according the design premisses.
2	See Annex A for valves requirements and general selection criteria.
3	Bolts, nuts and gaskets (only RTJ gaskets) must be Zn-Ni coated according to Annex B.
4	See Annex C for instruments, drains and vents typical piping arrangement.
5	Flanges ≤ 1 1/2" may be used, if strictly necessary.
6	See Annex E for Isolation gasket specifications.
7	Welding and Welding Inspection activities shall follow the requirements of these documents: I-ET-3010.00-1200-955-P4X-001-Welding.
26	See Annex A for valve casting qualification requirements.
27	See Annex D to check the piping spec range application for H2S and CO2 service.
29	Duplex stainless steel external coating shall be applied for the temperature limits according to I-ET-3010.00-1200-956-P4X-002 - General Painting.
44	For any variation between the inside diameter of valve, pipe and any fittings, the sharp edges shall be beveled with maximum slope of 1:4 (30° with the piping wall).
67	Branches with diameter greater than or equal to half the nominal diameter of the pipe shall be fitted with guide bars according to I-ET-3010.00-1200-295-P4X-001 -Requirements for Pig Launcher and Receiver Design.
77	The maximum allowable reduction of wall thickness shall be taken into consideration for 3D and 5D bends.
120	Wafer valves shall not be used with flammable or combustible services, according to NFPA definition.
122	Inspection of pipe and piping components shall follow ASTM A923 requirements.
125	Materials listed in this spec shall meet the requirements described in the notes and annexes of this document and also the requirements of the specific data sheet in IOGP S-563 as applicable. In case of conflict of criteria Petrobras shall be consulted. It shall be highlighted that the IOGP requirements is not applicable for: inconel 625 coating, which shall follow I-ET-3010.00-1200-955-P4X-001; supplementary NACE requirement for carbon steel which shall follow Annex D; and coating for bolts and nuts shall follow spec note number 3.



		OFFSHORE PRODUCTION FACILITIES ENGINEERING GUIDELINES	Doc: I-ET-3010.2Q-1200-200-P4X-001	Revision: Rev 0	Sheet 1 of 2
		OFFSHORE PRODUCTION FACILITIES ENGINEERING GUIDELINES			Issued by: SRGE/ESUP

Services (see notes): <b>CN</b> - Corrosive Chemical Injection (Except Sodium Hypochlorite and DBNPA); <b>F</b> - Safety System and Flare; <b>H</b> - Hydraulic Fluid; <b>P</b> - Process (non-corrosive hydrocarbon); <b>PC</b> - Process (Corrosive Hydrocarbon);	Material: <b>SS 316/316L</b>	Class: <b>2500</b>	Standard: <b>H3</b>
--	---------------------------------	-----------------------	------------------------

Pressure Rating (see notes)											
Temperature (°C)	-100	100	150								
Max Pressure (barg)	351	351	320.8								

Pipes and Fittings (see notes)													
Items		Code	Size	Wall	Class	Ends	Standard	Material					
Pipes	Pipe	T-322	1"	S-80S	-	PE	ASME B36.19	ASTM A312 TP 316/316L SML					
			1 1/2"	0.281"									
			2"	0.344"									
		T-323	3"	0.438"		BE	ASME B36.10/B36.19	ASTM A358 Type 316/316L Cl 1 or 3 WLD					
			4"	0.531"									
			6"	0.864"									
			8"	1.250"									
			10" - 12"	1.500"									
	14"	1.750"											
	16"	2.000"											
Fittings	Weldolet	C12-43	1" - 6"	According to pipe	-	BE	MSS SP-97	ASTM A182 Gr F316/316L					
	90 LR Elbow	C15-44	1" - 16"				ASME B16.9	ASTM A403 Gr WP316/316L					
	45 LR Elbow	C16-44											
	90 SR Elbow	C17-44											
	Cap	C22-44											
	Cross	C24-44											
	Red Tee	C21-44										1 1/2" - 16"	
	Conc. Red	C18-44										2" - 16"	
	Ecc. Red	C19-44											
Tee	C20-44												
Flanges	Blind	F-420-4X	1" - 3"	According to pipe	-	-	ISO 6162-2	ASTM A182 Gr F316/316L					
	Compact WN	F-2500-UX	1" - 16"				Class 2500					IX seal ring	ISO 27509
	Compact Blind	F-2500-VX	1" - 3"				max 420 bar					-	ISO 6162-2
	Hyd One-Piece Flange	F-420-3X	1" - 16"										
Gasket	Ring-Joint	J-2500-BV	1" - 16"	-	-	-	ISO 27509	Inconel					
Stud & Nuts	Stud and Nuts	P-2500-11	1/2" - 2 3/4"	-	-	-	ASME B1.1	A194 7LM, Zn-Ni					
		P-2500-13						A320 L7M, Zn-Ni					
								UNS N07718 API6ACRA					
Paddles	Figure-8 Blank	R8-2500-CS	1" - 4"	According to pipe	2500	IX Ring Compact flange ISO 27509	ASME B16.48	Stainless Steel ASTM A240 316					
	Paddle Blank	RA-2500-CS	6" - 16"				ISO 27509						
	Paddle Spacer	RE-2500-CS											





		OFFSHORE PRODUCTION FACILITIES ENGINEERING GUIDELINES	Doc: I-ET-3010.2Q-1200-200-P4X-001	Revision: Rev 0	Sheet 1 of 2
		OFFSHORE PRODUCTION FACILITIES ENGINEERING GUIDELINES			Issued by: SRGE/ESUP

Services (see notes): <b>CNI</b> - Corrosive Chemical Injection (Except Sodium Hypochlorite and DBNPA); <b>D</b> - Diesel; <b>F</b> - Safety System and Flare; <b>IW</b> - De-Aerated Sea Water Injection; <b>P</b> - Process (non-corrosive hydrocarbon); <b>PC</b> - Process (Corrosive Hydrocarbon);	Material: <b>Super Duplex</b>	Class: <b>2500</b>	Standard: <b>H12</b>
--	----------------------------------	-----------------------	-------------------------

Pressure Rating (see notes)											
Temperature (°C)	-50	115	120	190							
Max Pressure (barg)	410	410	406	360							

Pipes and Fittings (see notes)											
Items	Code	Size	Wall	Class	Ends	Standard	Material				
Pipes	T-303	1" - 1 1/2"	S-80S	-	PE	ASME B36.10/B36.19	ASTM A790 (UNS S32760) SML				
		2"			BE		ASTM A790 (UNS S32760) WLD				
		3" - 4"					ASTM A928 (UNS S32760 CI 1 or 3) WLD				
		6"									
		8"									
	T-304	10"	1.000"								
		12"	1.250"								
		14"	1.406"								
		16"	1.594"								
		18"	1.781"								
Fittings	Weldolet	C 12-30	1" - 10"	According to pipe	BE	MSS SP-97	ASTM A182 Gr F55 (UNS S32760)				
	90 LR Elbow	C 15-32	1" - 24"			ASME B16.9	ASTM A815 (UNS S32760)				
	45 LR Elbow	C 16-32									
	90 SR Elbow	C 17-32									
	Tee	C 20-32									
	Cap	C 22-32									
	Cross	C 24-32									
	Conc. Red	C 18-32	1 1/2" - 24"								
	Ecc. Red	C 19-32									
Red Tee	C 21-32										
Nipple	Straight Nipple	N-S231	1" - 1 1/2"	According to pipe	BBE	ASTM A733	ASTM A790 (UNS S32760)				
	Swage Conc Nipple	N-C232	1 1/2" - 4"			MSS SP-95	ASTM A815 (UNS S32760)				
	Swage Ecc Nipple	N-E232									
Flanges	Compact WN	F-2500-UH	1" - 24"	According to pipe	Class 2500	IX seal ring	ISO 27509	ASTM A182 Gr F55			
	Compact Blind	F-2500-VH									
Gasket	Ring-Joint	J-2500-BU	1" - 24"	-	Class 2500	Metallic Seal Joint	ISO 27509	Duplex , ASTM A182 F51			
Stud & Nuts	Stud and Nuts	P-2500-11	1/2" - 3 1/4"	-	-	-	ASME B1.1	A194 7LM, Zn-Ni			
		P-2500-13						A320 L7M, Zn-Ni			
								UNS N07718 API6ACRA			
Paddles	Figure-8 Blank	R8-2500-CX	1" - 4"	According to pipe	2500	IX Ring Compact flange ISO 27509	ASME B16.48	Superduplex ASTM A240 UNS32760			
	Paddle Blank	RA-2500-CX	6" - 24"				ISO 27509				
	Paddle Spacer	RE-2500-CX									





		OFFSHORE PRODUCTION FACILITIES ENGINEERING GUIDELINES	Doc: I-ET-3010.2Q-1200-200-P4X-001	Revision: Rev 0	Sheet 1 of 2
		OFFSHORE PRODUCTION FACILITIES ENGINEERING GUIDELINES			Issued by: SRGE/ESUP

Services (see notes): P - Process (non-corrosive hydrocarbon); FC - Process (Corrosive Hydrocarbon);	Material: Super Duplex	Class: 2500	Standard: H12P
---	---------------------------	----------------	-------------------

Pressure Rating (see notes)											
Temperature (°C)	-50	38	115								
Max Pressure (barg)	410	410	410								

**Pipes and Fittings (see notes)**

Items	Code	Size	Wall	Class	Ends	Standard	Material		
Pipes	T-303	1" - 1 1/2"	S-80S	-	PE	ASME B36.10/B36.19	ASTM A790 (UNS S32760) SML		
		2"			BE			ASTM A790 (UNS S32760) WLD	
		3" - 4"							0.438"
		6"							0.625"
	8"	0.812"							
	T-304	10"	1.000"				ASTM A928 (UNS S32760 Cl 1 or 3) WLD		
		12"	1.250"						
		14"	1.406"						
		16"	1.594"						
		18"	1.781"						
Fittings	90 LR Elbow	C15-32	According to pipe	-	BE	ASME B16.9	ASTM A815 (UNS S32760)		
	45 LR Elbow	C16-32				1" - 3"	MSS SP-97	ASTM A182 Gr F55 (UNS S32760)	
	90 SR Elbow	C17-32				1" - 8"	ASME B16.9	ASTM A815 (UNS S32760)	
	Weldolet	C12-30							
	Tee	C20-32				1 1/2" - 3"	NORSOK M-630 NBE2	ASTM A790 (UNS S32760)	
	Cap	C22-32							
	Cross	C24-32							
	Conc. Red	C18-32							
	Ecc. Red	C19-32				1 1/2" - 18"	ASTM A928 (UNS S32760 Cl 1 or 3)		
	Red Tee	C21-32							
	3D 45 Bend	C33-31				6" - 8"	ASTM A790 (UNS S32760)		
	5D 45 Bend	C34-31							
	3D 90 Bend	C35-31							
	5D 90 Bend	C36-31							
	3D 45 Bend	C33-41						12" - 18"	ASTM A928 (UNS S32760 Cl 1 or 3)
	5D 45 Bend	C34-41							
3D 90 Bend	C35-41								
5D 90 Bend	C36-41								
Nipple	Straight Nipple	N-S231	1" - 1 1/2"	According to pipe	-	BBE	ASTM A733	ASTM A790 (UNS S32760)	
Flanges	Compact WN	F-2500-UH	1" - 18"	According to pipe	Class 2500	IX seal ring	ISO 27509	ASTM A182 Gr F55	
	Compact Blind	F-2500-VH							
Gasket	Ring-Joint	J-2500-BU	1" - 18"	-	Class 2500	Metallic Seal Joint	ISO 27509	Duplex , ASTM A182 F51	
Stud & Nuts	Stud and Nuts	P-2500-11	1/2" - 2 3/4"	-	-	-	ASME B1.1	A194 7LM, Zn-Ni	
		P-2500-13						A320 L7M, Zn-Ni	
								UNS N07718 API6ACRA	
Paddles	Figure-8 Blank	R8-2500-CX	1" - 4"	According to pipe	2500	IX Ring Compact flange ISO 27509	ASME B16.48	Superduplex ASTM A240 UNS32760	
	Paddle Blank	RA-2500-CX	6" - 18"						
	Paddle Spacer	RE-2500-CX							

		OFFSHORE PRODUCTION FACILITIES ENGINEERING GUIDELINES	Doc: I-ET-3010.2Q-1200-200-P4X-001	Revision: Rev 0	Sheet: 2 of 2
		OFFSHORE PRODUCTION FACILITIES ENGINEERING GUIDELINES			Material: Super Duplex

### Valves (see notes)

Type	Size	CODE	Temp	Type	Size	CODE	Temp	Type	Size	CODE	Temp	Type	Size	CODE	Temp
Ball	1" - 1 1/2"	VES-2502-2-D308	-30C to 150C	Ball	2" - 18"	VES-2510-2-D33F	-46C to 150C	Ball	2" - 18"	VES-2510-3-D35G	-30C to 150C	Double Ball	1" - 2"	VDE-2510-2-D305	-50C to 150C
		VES-2502-2-D309	-50C to 200C			VES-2510-2-D33G				VES-2510-3-D372	-50C to 200C			VDE-2510-2-D3F1	-30C to 150C
		VES-2502-2-D3F9				VES-2510-2-D350				VES-2510-3-D373	-50C to 200C			VDE-2510-2-D3F3	-46C to 150C
		VES-2502-2-D3G8	-30C to 150C			VES-2510-2-D352	-30C to 150C			VES-2510-3-D37G				VDE-2510-2-D3F4	
		VES-2502-3-D309	-50C to 200C			VES-2510-2-D35F				VES-2510-4-D354	-30C to 150C			VDE-2510-2-D3F5	-50C to 150C
		VES-2502-3-D3F9				VES-2510-2-D35G				VES-2510-4-D35U				VGA-2501-2-D301	-50C to 150C
	2" - 18"	VES-2510-2-D314			VES-2510-2-D370		VES-2510-4-D374		Double Ball	3" - 8"	VDE-2510-2-D315	-30C to 150C			
		VES-2510-2-D318	-30C to 150C		VES-2510-2-D372	-50C to 200C	VES-2510-4-D37E	-50C to 200C			VDE-2510-2-D31F				
		VES-2510-2-D31F			VES-2510-2-D37F		VES-2510-4-D37U				VDE-2510-2-D33F	-46C to 150C			
		VES-2510-2-D31G			VES-2510-2-D37G		VDE-2510-2-D301	-30C to 150C			VDE-2510-2-D370				
		VES-2510-2-D334	-46C to 150C		VES-2510-3-D352	-30C to 150C	VDE-2510-2-D303	-46C to 150C			VDE-2510-2-D37F	-50C to 200C			
		VES-2510-2-D338			VES-2510-3-D353		VDE-2510-2-D304				VDE-2510-3-D37G				

### Branch (see notes)

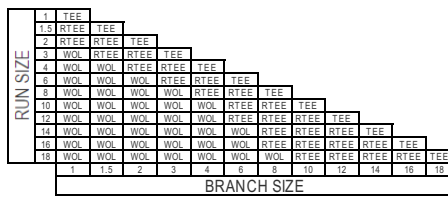

WOL - Weldolet

TEE - Tee



RTEE - Red Tee

HC - Half Coupling

SOC - Sockolet

### Notes

1	On the spec valve list, it may have valves codes which contain values of process data lower than spec limits. It shall be verified all valve process data (e.g.: pressure, temperature) in order to specify it according the design premisses.
2	See Annex A for valves requirements and general selection criteria.
3	Bolts, nuts and gaskets (only RTJ gaskets) must be Zn-Ni coated according to Annex B.
4	See Annex C for instruments, drains and vents typical piping arrangement.
5	Flanges ≤ 1 1/2" may be used, if strictly necessary.
6	See Annex E for Isolation gasket specifications.
7	Welding and Welding Inspection activities shall follow the requirements of these documents: I-ET-3010.00-1200-955-P4X-001-Welding.
8	All valves, pipes and components specified for hydrogen sulfide service shall be in accordance with ISO 15156 requirements. ASTM A 193 B7 / ASTM A 320 L7 studs with ASME B 16.5, ASME B 16.47 or API 6A flanges are acceptable for sour service fluids.
26	See Annex A for valve casting qualification requirements.
27	See Annex D to check the piping spec range application for H2S and CO2 service.
44	For any variation between the inside diameter of valve, pipe and any fittings, the sharp edges shall be beveled with maximum slope of 1:4 (30° with the piping wall).
48	Superduplex external coating shall be applied for the temperature limits according to I-ET-3010.00-1200-956-P4X-002 - General Painting.
67	Branches with diameter greater than or equal to half the nominal diameter of the pipe shall be fitted with guide bars according to I-ET-3010.00-1200-295-P4X-001 -Requirements for Pig Launcher and Receiver Design.
77	The maximum allowable reduction of wall thickness shall be taken into consideration for 3D and 5D bends.
120	Wafer valves shall not be used with flammable or combustible services, according to NFPA definition.
122	Inspection of pipe and piping components shall follow ASTM A923 requirements.
125	Materials listed in this spec shall meet the requirements described in the notes and annexes of this document and also the requirements of the specific data sheet in IOGP S-563 as applicable. In case of conflict of criteria Petrobras shall be consulted. It shall be highlighted that the IOGP requirements is not applicable for: inconel 625 coating, which shall follow I-ET-3010.00-1200-955-P4X-001; supplementary NACE requirement for carbon steel which shall follow Annex D; and coating for bolts and nuts shall follow spec note number 3.
131	ASME flanges until NPS 12 may be used only for PSV assembly.
139	The TOPSIDE flange connection with Riser shall be Swivel type according to API SPEC 17D type 17SV. It shall be evaluated by FEM and customized to fit the hub flange with the piping thickness.
155	Studs ASTM A 320 L7M are recommended for temperatures down to -73 °C. For temperature below -73 °C (e.g. depressurization) studs UNS N07718 shall be used.

		OFFSHORE PRODUCTION FACILITIES ENGINEERING GUIDELINES	Doc: I-ET-3010.2Q-1200-200-P4X-001	Revision: Rev 0	Sheet 1 of 2
		OFFSHORE PRODUCTION FACILITIES ENGINEERING GUIDELINES			Issued by: SRGE/ESUP



Services (see notes): <b>CNI</b> - Corrosive Chemical Injection (Except Sodium Hypochlorite and DBNPA); <b>PC</b> - Process (Corrosive Hydrocarbon);	Material: <b>Duplex</b>	Class: <b>2500</b>	Standard: <b>H16</b>
---	----------------------------	-----------------------	-------------------------

Pressure Rating (see notes)											
Temperature (°C)	-50	130									
Max Pressure (barg)	365	365									

Pipes and Fittings (see notes)											
Items	Code	Size	Wall	Class	Ends	Standard	Material				
Pipes	T-301	1" - 1 1/2"	S-80S	-	PE	ASME B36.10/B36.19	ASTM A790 (UNS S31803) SML				
		2"	0.250"		BE						
		3" - 4"	0.438"								
		6"	0.719"								
	T-302	8"	0.875"				-	BE	ASME B36.10/B36.19	ASTM A928 (UNS S31803 Cl 1 or 3) WLD	
		10"	1.125"								
		12"	1.250"								
		14"	1.406"								
		16"	1.594"								
		18"	1.781"								
		20"	1.969"								
		24"	2.344"								
Fittings	Weldolet	C 12-27	1" - 10"	According to pipe	BE	MSS SP-97	ASTM A182 Gr F51 (UNS S31803)				
	90 LR Elbow	C 15-29	1" - 24"			ASME B16.9	ASTM A815 (UNS S31803)				
	45 LR Elbow	C 16-29									
	90 SR Elbow	C 17-29									
	Tee	C 20-29									
	Cap	C 22-29	1 1/2" - 24"								
	Cross	C 24-29									
	Conc. Red	C 18-29									
	Ecc. Red	C 19-29	2" - 24"								
Red Tee	C 21-29										
Nipple	Straight Nipple	N-S228	1" - 1 1/2"	According to pipe	BBE	ASTM A733	ASTM A790 (UNS S31803)				
	Swage Conc Nipple	N-C229	1 1/2" - 4"			MSS SP-95	ASTM A815 (UNS S31803)				
	Swage Ecc Nipple	N-E229									
Flanges	Compact WN	F-2500-UG	1" - 24"	According to pipe	Class 2500	IX seal ring	ISO 27509	ASTM A182 Gr F51			
	Compact Blind	F-2500-VG									
Gasket	Ring-Joint	J-2500-BU	1" - 24"	-	Class 2500	Metallic Seal Joint	ISO 27509	Duplex, ASTM A182 F51			
Stud & Nuts	Stud and Nuts	P-2500-11	1/2" - 3 1/4"	-	-	-	ASME B1.1	A194 7LM, Zn-Ni A320 L7M, Zn-Ni			
Paddles	Figure-8 Blank	R8-2500-CD	1" - 4"	According to pipe	2500	IX Ring Compact flange ISO 27509	ASME B16.48	Duplex Stainless Steel ASTM A240 UNS31803			
	Paddle Blank	RA-2500-CD	6" - 24"				ISO 27509				
	Paddle Spacer	RE-2500-CD									





		OFFSHORE PRODUCTION FACILITIES ENGINEERING GUIDELINES	Doc: I-ET-3010.2Q-1200-200-P4X-001	Revision: Rev 0	Sheet 1 of 2
		OFFSHORE PRODUCTION FACILITIES ENGINEERING GUIDELINES			Issued by: SRGE/ESUP

Services (see notes): <b>W</b> - De-Aerated Sea Water Injection; <b>PC</b> - Process (Corrosive Hydrocarbon);	Material: <b>CS Inconel Clad.</b>	Class: <b>2500</b>	Standard: <b>H30</b>
--	--------------------------------------	-----------------------	-------------------------

Pressure Rating (see notes)										
Temperature (°C)	-20	120								
Max Pressure (barg)	351	351								

**Pipes and Fittings (see notes)**

Items	Code	Size	Wall	Class	Ends	Standard	Material	
<b>Pipes</b>	T-203	1" - 1 1/2"	S-80S	-	PE	ASME B36.10/B36.19	ASTM B444 Gr 1 (UNS N06625) SML	
		2" - 3"			BE			
	T-107	4" - 12"	S-160			ASME B36.10	API 5L Gr X65 PSL 2 (SML or WLD SAW)	
		14"			2.000"			
		16" - 24"	S-160			API 5L Gr X65 PSL 2 WLD SAW		
<b>Fittings</b>	Weldolet	C12-33	1" - 3"	According to pipe	-	ASME B16.9	ASTM B366 (UNS N06625)	
	90 LR Elbow	C15-33						
	45 LR Elbow	C16-33						
	90 SR Elbow	C17-33						
	Tee	C20-33						
	Cap	C22-33						
	Cross	C24-33						
	Weldolet	C12-22	1" - 10"			MSS SP-97	ASTM A694 Gr F65	
	Conc. Red	C18-33						
	Ecc. Red	C19-33						
	Red Tee	C21-33	1 1/2" - 3"			ASME B16.9	ASTM B366 (UNS N06625)	
	90 LR Elbow	C15-22						
	45 LR Elbow	C16-22						
	90 SR Elbow	C17-22	4" - 24"			MSS SP-75	ASTM A860 WPHY65	
	Conc. Red	C18-22						
	Ecc. Red	C19-22						
	Tee	C20-22						
	Red Tee	C21-22						
Cap	C22-22							
Cross	C24-22							
<b>Nipple</b>	Straight Nipple	N-S239	1" - 1 1/2"	According to pipe	-	BBE	ASTM A733	ASTM B444 Gr 1 (UNS N06625)
	Swage Conc Nipple	N-C233	1 1/2" - 4"				MSS SP-95	ASTM B366 (UNS N06625)
	Swage Ecc Nipple	N-E233						
<b>Flanges</b>	Compact WN	F-2500-UL	1" - 3"	According to pipe	Class 2500	IX seal ring	ISO 27509	ASTM B564 (UNS N06625)
		F-2500-UD	4" - 24"					ASTM A694 Gr F65 Cladded
	Compact Blind	F-2500-VL	1" - 3"					ASTM B564 (UNS N06625)
		F-2500-VD	4" - 24"					ASTM A694 Gr F65 Cladded
<b>Gasket</b>	Ring-Joint	J-2500-BV	4" - 24"	-	Class 2500	Metallic Seal Joint	ISO 27509	Inconel
<b>Stud &amp; Nuts</b>	Stud and Nuts	P-2500-11	1/2" - 3 1/4"	-	-	-	ASME B1.1	A194 7LM, Zn-Ni
								A320 L7M, Zn-Ni
<b>Paddles</b>	Figure-8 Blank	R8-2500-CI	1" - 4"	According to pipe	2500	IX Ring Compact flange ISO 27509	ASME B16.48	Carbon Steel ASTM A516 GR60 with Inconel 625 layer
	Paddle Blank	RA-2500-CI	6" - 24"					
	Paddle Spacer	RE-2500-CI						

**Valves** (see notes)

Type	Size	CODE	Temp	Type	Size	CODE	Temp	Type	Size	CODE	Temp	Type	Size	CODE	Temp				
Check	1" - 1 1/2"	VRE-2500-1-N102	-100C to 400C	Ball	1" - 1 1/2"	VES-2502-2-N109	-100C to 200C	Ball	2" - 24"	VES-2510-2-C572	-29C to 200C	Double Ball	1" - 2"	VDE-2510-2-N103	-46C to 150C				
		VRE-2510-2-C512	-29C to 150C				VES-2502-2-N1F8			-30C to 120C						VES-2510-2-C57F		VDE-2510-2-N104	
		VRE-2510-2-C515	-29C to 200C				VES-2502-2-N1F9			-100C to 200C						VES-2510-2-C57G		VDE-2510-2-N1F3	
	VRE-2510-2-C535	-29C to 200C				VES-2502-3-N109	-100C to 200C							VES-2510-3-C572			VDE-2510-2-N1F4		
	VAG-6000-1-N102	-100C to 400C				VES-2502-3-N1F9	-100C to 200C							VES-2510-3-C573			VDE-2510-2-C515		
Needle	1" - 1 1/2"	VAG-6000-1-N1F2	-100C to 400C			VES-2510R-2-C534	-29C to 150C			VES-2510-3-C57G			VDE-2510-2-C51F	-29C to 150C		Axial On-off	6" - 24"	VAX-2510-3-D301	-50C to 150C
		VAX-2510-4-D301	-50C to 150C			VES-2510-2-C514	-29C to 150C			VES-2510-4-C574			VAX-2510-4-D301	-50C to 150C					
Axial On-off	6" - 24"	VAX-2510-4-D302	-50C to 150C			VES-2510-2-C534	-29C to 150C			VES-2510-4-C575			VAX-2510-4-D302	-50C to 150C		Globe	2" - 16"	VGL-2510-2-C501	-29C to 400C
		VES-2502-1-N108	-30C to 120C			VES-2510-2-C538	-29C to 150C			VES-2510-4-C57E			VGL-2510-2-C501	-29C to 400C					
Ball	1" - 1 1/2"	VES-2502-1-N108	-30C to 120C			VES-2510-2-C53F	-29C to 150C			VES-2510-4-C57U			VGL-2510-2-C501	-29C to 400C					
		VES-2502-1-N109	-100C to 200C		VES-2510-2-C53G	-29C to 150C		VDE-2510-2-N101	-30C to 150C										
		VES-2502-2-N108	-30C to 120C		VES-2510-2-C570	-29C to 200C													



**Branch** (see notes)

RUN SIZE	1	TEE																		
	1.5	RTEE	TEE																	
	2	RTEE	RTEE	TEE																
	3	WOL	RTEE	RTEE	TEE															
	4	WOL	WOL	RTEE	RTEE	TEE														
	6	WOL	WOL	WOL	RTEE	RTEE	TEE													
	8	WOL	WOL	WOL	WOL	RTEE	RTEE	TEE												
	10	WOL	WOL	WOL	WOL	WOL	RTEE	RTEE	TEE											
	12	WOL	WOL	WOL	WOL	WOL	RTEE	RTEE	RTEE	TEE										
	14	WOL	WOL	WOL	WOL	WOL	WOL	RTEE	RTEE	RTEE	TEE									
16	WOL	WOL	WOL	WOL	WOL	WOL	RTEE	RTEE	RTEE	RTEE	TEE									
18	WOL	WOL	WOL	WOL	WOL	WOL	RTEE	RTEE	RTEE	RTEE	TEE									
20	WOL	WOL	WOL	WOL	WOL	WOL	RTEE	RTEE	RTEE	RTEE	RTEE	TEE								
24	WOL	WOL	WOL	WOL	WOL	WOL	RTEE	RTEE	RTEE	RTEE	RTEE	RTEE	TEE							
BRANCH SIZE																				
	1	1.5	2	3	4	6	8	10	12	14	16	18	20	24						

WOL - Weldolet  
 TEE - Tee  
 RTEE - Red Tee  
 HC - Half Coupling  
 SOC - Sockolet

**Notes**

1	On the spec valve list, it may have valves codes which contain values of process data lower than spec limits. It shall be verified all valve process data (e.g.: pressure, temperature) in order to specify it according the design premisses.
2	See Annex A for valves requirements and general selection criteria.
3	Bolts,nuts and gaskets (only RTJ gaskets) must be Zn-Ni coated according to Annex B.
4	See Annex C for instruments, drains and vents typical piping arrangement.
6	See Annex E for Isolation gasket specifications.
7	Welding and Welding Inspection activities shall follow the requeriments of these documents: I-ET-3010.00-1200-955-P4X-001-Welding.
8	All valves, pipes and components specified for hydrogen sulfide service shall be in accordance with ISO 15156 requirements. ASTM A 193 B7 / ASTM A 320 L7 studs with ASME B 16.5, ASME B 16.47 or API 6A flanges are acceptable for sour service fluids.
9	Charpy impact test is required at the minimum temperature of this spec, according to ASME B31.3 and API 5L requirements. Applicable to both base material and WPS qualification.
11	For API 5L pipe the maximum carbon equivalent is CE iiw = 0,43% or CE pcm = 0,25%.
27	See Annex D to check the piping spec range application for H2S and CO2 service.
42	Piping, fittings and accessories shall have internal Inconel® 625 cladding according to I-ET-3010.00-1200-955-P4X-001 - Welding.
70	Use this Spec only up to SDV.
120	Wafer valves shall not be used with flammable or combustible services, according to NFPA definition.
125	Materials listed in this spec shall meet the requirements described in the notes and annexes of this document and also the requirements of the specific data sheet in IOGP S-563 as applicable. In case of conflict of criteria Petrobras shall be consulted. It shall be highlighted that the IOGP requirements is not applicable for: inconel 625 coating, which shall follow I-ET-3010.00-1200-955-P4X-001; supplementary NACE requirement for carbon steel which shall follow Annex D; and coating for bolts and nuts shall follow spec note number 3.
131	ASME flanges until NPS 12 may be used only for PSV assembly.
138	Welded pipe to API 5L: 100 % RT of weld seam.
159	Weld overlay shall fully extend on flange face up to groove outer diameter or raised face outer diameter. The minimum thickness for inconel layer to be mesured after machining. This note is valid for piping and valve flanges.

		OFFSHORE PRODUCTION FACILITIES ENGINEERING GUIDELINES				Doc: I-ET-3010.2Q-1200-200-P4X-001	Revision: Rev 0	Sheet 1 of 2
		OFFSHORE PRODUCTION FACILITIES ENGINEERING GUIDELINES				Issued by: SRGE/ESUP	Code: ASME B31.3	Corr. Allow.: -

Services (see notes): <b>CI</b> - Chemical Injection (non-corrosive); <b>CNI</b> - Corrosive Chemical Injection (Except Sodium Hypochlorite and DBNPA); <b>F</b> - Safety System and Flare;					Material: Tubing 6Mo	Class: -	Standard: T60A
--	--	--	--	--	-------------------------	-------------	-------------------

**Pressure Rating** (see notes)

Temperature (°C)	0	60								
Max Pressure (barg)	150	150								

**Pipes and Fittings** (see notes)

Items	Code	Size	Wall	Class	Ends	Standard	Material	
<b>Pipes</b>	Pipe	T-325	1/4"	0.049"	-	PE	-	
			3/8" - 1/2"					
			5/8"					
			3/4"					
		1"	0.083"					
<b>Fittings</b>	Compression Fitting	C60-40	1/4" - 1"	-	6000	OD x THD	according to manufacturer	Compression fitting with double ferrule, body AISI 316, ferrules and nuts in AISI 316.
						OD x SW		
						OD x OD		

**Valves (see notes)**

Type	Size	CODE	Temp	Type	Size	CODE	Temp	Type	Size	CODE	Temp	Type	Size	CODE	Temp
Instrumentation Needle	1/4" - 1"	VAGI-6000-1-S201	0C to 200C	Instrumentation Double Ball	1/4" - 1"	VDEI-6000-1-S201	0C to 200C	Instrumentation Ball	1/4" - 1"	VESI-6000-1-S202	0C to 200C	Instrumentation Check	1/4" - 1"	VREI-6000-1-S202	0C to 90C
		VAGI-6000-1-S202				VESI-6000-1-S201				VREI-6000-1-S201					

**Branch (see notes)**

RUN SIZE	0.25	TEE
	0.375	RTEE
	0.5	RTEE
	0.625	RTEE
	0.75	RTEE
1	RTEE	
BRANCH SIZE		

- WOL - Weldolet
- TEE - Tee
- RTEE - Red Tee
- HC - Half Coupling
- SOC - Sockolet

**Notes**

2	See Annex A for valves requirements and general selection criteria.
8	All valves, pipes and components specified for hydrogen sulfide service shall be in accordance with ISO 15156 requirements. ASTM A 193 B7 / ASTM A 320 L7 studs with ASME B 16.5, ASME B 16.47 or API 6A flanges are acceptable for sour service fluids.
81	The tubing shall be prepared (cut, burred, and bent) only with the tools recommended by the OD fittings manufacturer.
89	The maximum work pressure for fittings shall be above the maximum work pressure of the tubing for all operation conditions.
93	Seal or fillet welds are not allowed in OD fittings and valves assembly.
95	Proper tools shall be used to assemble the OD fittings (feeler gauge, wrenches, etc.) in accordance with the fittings manufacturer instructions. Special attention shall be given for assemblies with OD 1" and larger, where preswage must be done.
125	Materials listed in this spec shall meet the requirements described in the notes and annexes of this document and also the requirements of the specific data sheet in IOGP S-563 as applicable. In case of conflict of criteria Petrobras shall be consulted. It shall be highlighted that the IOGP requirements is not applicable for: inconel 625 coating, which shall follow I-ET-3010.00-1200-955-P4X-001; supplementary NACE requirement for carbon steel which shall follow Annex D; and coating for bolts and nuts shall follow spec note number 3.
140	Shall be followed the criteria for purchase, design, construction, assembly and inspection of tubing system established in the technical specification I-ET-3010.00-1200-800-P4X-015.
141	Hydrotest according to ASME 31.3 and limited to maximum working pressure qualified by manufacturer.

# **ANNEX A – VALVES (Mandatory)**

## INDEX

<b>A.1.SCOPE .....</b>	<b>5</b>
<b>A.2.NORMATIVE REFERENCES .....</b>	<b>5</b>
<b>A.3.TERMS AND DEFINITIONS .....</b>	<b>8</b>
<b>A.4.SYMBOLS AND ABBREVIATED TERMS .....</b>	<b>9</b>
<b>A.5.VALVE SELECTION GUIDE .....</b>	<b>11</b>
A.5.1. INTRODUCTION .....	11
A.5.2. VALVE SPECIFICATION LEVEL (VSL) - CLASSIFICATION .....	11
A.5.3. VALVE SPECIFICATION LEVEL (VSL) - REQUIREMENTS .....	12
A.5.4. VALVE FEATURES AND TYPICAL APPLICATIONS .....	13
<b>A.6.GENERAL DESIGN REQUIREMENTS .....</b>	<b>15</b>
A.6.1. VALVE .....	15
A.6.2. ACTUATOR .....	22
<b>A.7.SPECIFIC DESIGN REQUIREMENTS .....</b>	<b>23</b>
A.7.1. BALL VALVE .....	23
A.7.2. GATE VALVE .....	41
A.7.3. CHECK VALVE .....	45
A.7.4. GLOBE VALVE .....	48
A.7.5. BUTTERFLY VALVE .....	49
A.7.6. NON-METALLIC VALVE .....	53
<b>A.8.MATERIALS &amp; FABRICATION .....</b>	<b>54</b>
A.8.1. REQUIREMENTS FOR CASTING OF DUPLEX & SUPERDUPLEX .....	54
A.8.2. COATINGS .....	60
A.8.3. ALTERNATIVE MATERIALS .....	63
A.8.4. DRAIN, VENTS AND INJECTION CONNECTIONS .....	64
<b>A.9.INSPECTION &amp; TESTING .....</b>	<b>64</b>
A.9.1. INSPECTION REQUIREMENTS .....	64
A.9.2. DESIGN VALIDATION .....	66
A.9.3. FACTORY ACCEPTANCE TEST (FAT) REQUIREMENTS .....	67
<b>A.10. HANDLING, STORING &amp; SHIPPING .....</b>	<b>72</b>
<b>A.11. DOCUMENTATION .....</b>	<b>73</b>
A.11.1. DOCUMENTATION FORMATS & QUALITY .....	73
A.11.2. DATA BOOK .....	73
A.11.3. USER MANUAL .....	74
A.11.4. DOCUMENTATION OF PRESERVATION, PROTECTION AND PACKING .....	74
A.11.5. VALVE CODE .....	75
<b>A.12. VALVE DATASHEET - VDS .....</b>	<b>83</b>

## FIGURES

FIGURE A.1 – EXAMPLE OF USE OF DRAIN AND VENT PLUG .....	15
FIGURE A.2 – EXAMPLE OF NAMEPLATES WITH INDICATION OF SEAT CONFIGURATION .....	22
FIGURE A.3 – BALL TYPE .....	24
FIGURE A.4 – SPE/SR SEAT ASSEMBLY MECHANISM (ILLUSTRATION ON A SOFT BALL VALVE) .....	26
FIGURE A.5 – DPE SEAT ASSEMBLY MECHANISM (ILLUSTRATION ON A SOFT BALL VALVE) .....	26
FIGURE A.6 – DBB FEATURE (REF.: DOUBLE BLOCK AND BLEED - TYPE B OF API 6D) .....	27
FIGURE A.7 – DIB-1 FEATURE (REF.: DOUBLE ISOLATION AND BLEED - TYPE B OF API 6D) .....	27
FIGURE A.8 – DIB-2 FEATURE (REF.: DOUBLE ISOLATION AND BLEED - TYPE B OF API 6D) .....	27
FIGURE A.9 – ILLUSTRATION OF TYPICAL CATEGORY B (TRIPLE OFFSET) SEAT CONFIGURATIONS .....	51

## TABLES

TABLE A.1 – CLASSIFICATION OF ACCUMULATED ENERGY AND HIGH DEMAND VALVES .....	12
TABLE A.2 – VALVE SPECIFICATION LEVEL (VSL) CLASSIFICATION .....	12
TABLE A.3 – VALVE SPECIFICATION LEVEL (VSL) REQUIREMENTS .....	13
TABLE A.4 - VALVE FEATURES AND TYPICAL APPLICATIONS .....	14
TABLE A.5 – MATERIAL CLASSES .....	16
TABLE A.6 – BODY MATERIAL, ACCORDING TO MATERIAL CLASS .....	16
TABLE A.7 – PROCESS FABRICATION FOR BODY MATERIALS ACCORDING TO VSL .....	17
TABLE A.8 – TIGHTNESS CLASS FOR STEM SEALS - FUGITIVE EMISSIONS (REF.: ISO 15848 PART 1) .....	18
TABLE A.9 – TIGHTNESS CLASS FOR BODY SEALS - FUGITIVE EMISSIONS (REF.: ISO 15848 PART 1) .....	19
TABLE A.10 – TIGHTNESS CLASS FOR STEM (OR SHAFT) SEALS WITH METHANE - FUGITIVE EMISSIONS (REF.: ISO 15848 PART 1) .....	19
TABLE A.11 – LEAKAGE FROM BODY SEALS WITH METHANE - FUGITIVE EMISSIONS (REF.: ISO 15848 PART 1) .....	19
TABLE A.12 – ENDURANCE CLASS ACCORDING VSL CLASSIFICATION .....	19
TABLE A.13 – TEMPERATURE CLASS OF FUGITIVE EMISSIONS (REF.: ISO 15848 PART 1) .....	19
TABLE A.14 – SIL LEVELS .....	20
TABLE A.15 - STUDS, BOLTS AND NUTS MATERIAL SPECIFICATION .....	20
TABLE A.16 – ACTUATORS TYPE .....	23
TABLE A.17 – DESIGN STANDARDS FOR BALL VALVES .....	25
TABLE A.18 – MOUNTING TYPE FOR BALL VALVES .....	25
TABLE A.19 – ISOLATION VALVE CONFIGURATION FOR BALL VALVES .....	28
TABLE A.20 – NON-METALLIC MATERIALS FOR SEAT INSERT SEAL DESIGN .....	28
TABLE A.21 – SEAL GROUPS MATERIALS .....	29
TABLE A.22 – INDICATION OF GROUPS OF SEALS ACCORDING TO FLUID CLASS AND TEMPERATURE RANGE .....	30
TABLE A.23 – SEALS GROUP CLASSIFICATION INTO VALVE CODE .....	31
TABLE A.24 – NIPPLE CLASSIFICATION INTO VALVE CODE .....	31
TABLE A.25 – TYPICAL CONFIGURATIONS FOR BALL METALLIC VALVES UP TO NPS 1 1/2 (“FORGED” VALVES) .....	32
TABLE A.26 – TYPICAL CONFIGURATIONS FOR METALLIC BALL VALVES NPS 2 AND ABOVE AND DOUBLE BALL VALVE NPS 3 AND ABOVE .....	34
TABLE A.27 – TYPICAL CONFIGURATIONS FOR RISING STEM BALL VALVES .....	34
TABLE A.28 – TYPICAL CONFIGURATIONS FOR METALLIC DOUBLE BALL VALVES UP TO NPS 2 .....	35
TABLE A.29 – STEM MATERIALS ACCORDING TO MATERIAL CLASS & PRESSURE CLASS OF THE VALVE .....	36
TABLE A.30 – SPRING MATERIAL .....	37
TABLE A.31 – SPECIFICATION OF METALLIC COATING (PARTIAL CLAD) FOR BALL VALVES .....	37
TABLE A.32 – SPECIFICATION OF HARD COATING ON SEATS / BALL ON SOFT BALL VALVES .....	38
TABLE A.33 – SPECIFICATION OF HARD COATING ON SEATS / BALL ON METAL-TO-METAL BALL VALVES .....	38
TABLE A.34 – TYPICAL CONFIGURATIONS FOR SOFT SEATED BALL VALVES ACCORDING TO MATERIAL CLASS .....	38



TABLE A.35 – TYPICAL CONFIGURATIONS FOR METAL-TO-METAL SEATED BALL VALVES ACCORDING TO MATERIAL CLASS .....	40
TABLE A.36 – DESIGN STANDARDS FOR GATE VALVES .....	42
TABLE A.37 – TRIM MATERIAL CONFIGURATION FOR SOLID WEDGE GATE VALVES .....	43
TABLE A.38 – OBTURATOR TYPE FOR GATE VALVES .....	44
TABLE A.39 – TRIM SELECTION.....	44
TABLE A.40 – DESIGN STANDARDS FOR CHECK VALVES.....	45
TABLE A.41 – SEAL GROUP MATERIALS FOR SOFT SEATED DUAL PLATE CHECK VALVE.....	46
TABLE A.42 – TRIM MATERIAL ACCORDING TO MATERIAL CLASS.....	46
TABLE A.43 – OBTURATOR TYPE FOR CHECK VALVES.....	47
TABLE A.44 – TRIM SELECTION.....	47
TABLE A.45 – DESIGN STANDARDS FOR GLOBE VALVES.....	48
TABLE A.46 – TRIM DESIGN CODE FOR GLOBE VALVES.....	49
TABLE A.47 – OBTURATOR TYPE FOR GLOBE VALVES.....	49
TABLE A.48 – DESIGN STANDARDS FOR BUTTERFLY VALVES .....	50
TABLE A.49 – NON-METALLIC MATERIALS FOR SEATS / STEM SEAL DESIGN.....	50
TABLE A.50 – MATERIAL CLASS CONFIGURATION FOR BUTTERFLY VALVES .....	51
TABLE A.51 – DISC & SEAT CONFIGURATION FOR BUTTERFLY VALVES .....	52
TABLE A.52 – END CONNECTION CONFIGURATION FOR BUTTERFLY VALVES .....	53
TABLE A.53 – MATERIAL CONFIGURATION FOR NON-METALLIC VALVES.....	53
TABLE A.54 – MINIMUM PRESSURE (PSIG) – TEMPERATURE RATING FOR NON-METALLIC BALL VALVES.....	53
TABLE A.55 – MINIMUM PRESSURE (PSIG) – TEMPERATURE RATING FOR NON-METALLIC CHECK VALVES .....	54
TABLE A.56 – MINIMUM PRESSURE (PSIG) – TEMPERATURE RATING FOR NON-METALLIC BUTTERFLY VALVES.....	54
TABLE A.57 – MINIMUM VALUES FOR TENSION TESTS .....	57
TABLE A.58 - MAXIMUM LEVELS OF SEVERITY BY DEFECT BY THICKNESS .....	58
TABLE A.59 – CHEMICAL COMPOSITION FOR ASTM A522 – TYPE I.....	65
TABLE A.60 – DESIGN VALIDATION REQUIREMENTS ACCORDING VSL CLASSIFICATION.....	66
TABLE A.61 – QSL / PSL REQUIREMENT ACCORDING VSL CLASSIFICATION.....	69
TABLE A.62 – TIGHTNESS CLASS FOR STEM SEALS - FUGITIVE EMISSIONS (REF.: ISO 15848 PART 1).....	71
TABLE A.63 – TIGHTNESS CLASS FOR BODY SEALS - FUGITIVE EMISSIONS (REF.: ISO 15848 PART 1).....	71
TABLE A.64 – IDENTIFICATION OF BODY MATERIAL CODE, ACCORDING TO RESPECTIVE MATERIAL CLASS .....	79
TABLE A.65 – IDENTIFICATION OF OBTURATOR TYPE, ACCORDING TO VALVE TYPE .....	80
TABLE A.66 – IDENTIFICATION OF TRIM DESIGN, ACCORDING TO VALVE TYPE.....	81

## A.1. SCOPE

The scope of this document is related to axial, ball, butterfly, check, diaphragm, gate, globe, needle and plug valves, either manually actuated or operated by actuators, for use in Exploration and Production (E&P) business area, onshore and offshore, especially in oil and gas production and their process facilities (topsides and hull).

This document specifies requirements for valves concerning the following topics: design, performance, materials, manufacturing, testing, inspection, marking, handling, storing, shipment and documentation.

This document is not applicable to control valves. DR-ENGP-I-1.5 addresses main requirements for control valves and also establishes supplementary requirements for emergency Shut Down Valves (SDV) and BlowDown Valves (BDV).

The valves considered in this document may be acquired directly by PETROBRAS or through a Contract, as example EPC (Engineering, Procurement and Construction), in both cases to be used for existing facilities or new projects.

## A.2. NORMATIVE REFERENCES

Note: The Standards referred herein shall be considered in their latest edition/revision.

API 594, *Check valves: Flanged, Lug, Wafer and Butt-welding*

API 598, *Valve Inspection and Testing*

API 599, *Metal Plug Valves-Flanged, Threaded and Welding Ends*

API 600, *Steel Gate Valves-Flanged and Butt-Welding Ends, Bolted Bonnets*

API 602, *Steel Gate, Globe and Check Valves for Sizes DN 100 and Smaller for the Petroleum and Natural Gas Industries*

API 603, *Corrosion-resistant, Bolted Bonnet Gate Valves—Flanged and Butt-welding Ends*

API 607, *Fire Test for Quarter-turn Valves and Valves Equipped with Nonmetallic Seats*

API 609, *Butterfly Valves: Double-flanged, Lug – and Wafer-type*

API 6A, *Specification for Wellhead and Christmas Tree Equipment*

API 6D, *Specification for Pipeline and Piping Valves*

ASME B 1.1, *Unified Inch Screw Threads, UN and UNR Thread Form*

ASME B 18.2.1, *Square, Hex, Heavy Hex, and Askew Head Bolts and Hex, Heavy Hex, Hex Flange, Lobed Head, and Lag Screws (Inch Series)*

ASME B 18.2.2, *Nuts for General Applications: Machine Screw Nuts, Hex, Square, Hex Flange, and Coupling Nuts (Inch Series)*

ASME B 31.3, *Process piping*

ASME B1.20.1, *Pipe Threads, General Purpose (Inch)*

ASME B16.1, *Gray Iron Pipe Flanges and Flanged Fittings: Classes 25, 125, and 250*

ASME B16.10, *Face-to-face and end-to-end dimensions of valves*

ASME B16.11, *Forged fittings, socket-welding and threaded*

ASME B16.20, *Metallic Gaskets for Pipe Flanges: Ring-Joint, Spiral-Wound, and Jacketed*

ASME B16.25, *Buttwelding ends*

ASME B16.34, *Valves – Flanged, threaded and welding end*

ASME B16.47, *Large Diameter Steel Flanges: NPS 26 through NPS 60 Metric/Inch Standard*

ASME B16.5, *Pipe Flanges and Flanged Fittings: NPS 1/2 through NPS 24 Metric/Inch Standard*

ASME B31.4, *Pipeline Transportation Systems for Liquid Hydrocarbons and Other Liquids*

ASME B31.8, *Gas Transmission and Distribution Piping Systems*

ASME SA–995–04, *Specification for Castings, Austenitic-Ferritic (Duplex) Stainless Steel, for Pressure-Containing Parts*

ASME SEC VIII DIV 1 APPENDIX 7, *Examination of Steel Castings*

ASME SEC VIII DIV 1 SUB A PT UG, *General Requirements for All Methods of Construction and All Materials*

ASME Section II, Part D, *Boiler and Pressure Vessel Code (BPVC), Section II: Materials – Part D: Properties (Metric)*

ASME Section VIII, Division 1, *Boiler and Pressure Vessel Code (BPVC), Section VIII, Division 1: Rules for Construction of Pressure Vessels*

ASME Section VIII, Division 2, 2004 Edition, *Boiler and Pressure Vessel Code, Section VIII, Division 2: Alternative Rules*

ASTM A370–05, *Test Methods and Definitions for Mechanical Testing of Steel Products*

ASTM A488 / A488M–04, *Steel Castings, Welding, Qualifications of Procedures and Personnel*

ASTM A703 / A703M–04A, *Steel Castings, General Requirements, for Pressure-Containing Parts*

ASTM A781 / A781M–05, *Castings, Steel and Alloy, Common Requirements, for General Industrial Use*

ASTM A802 / A802M–95, *Steel Castings, Surface Acceptance Standards, Visual Examination*

ASTM A903 / A903M–99, *Steel Castings, Surface Acceptance Standards, Magnetic Particle and Liquid Penetrant Inspection*

ASTM A995 / A995M–98, *Specification for Castings, Austenitic-Ferritic (Duplex) Stainless Steel, for Pressure-Containing Parts*

ASTM B584, *Specification for copper alloy sand castings for general applications*

ASTM B849, *Specification for pre-treatments of iron or steel for reducing risk of hydrogen embrittlement*

ASTM B850, *Standard Guide for post-coating treatments of steel for reducing the risk of hydrogen embrittlement*

ASTM E1030–00, *Radiograph Examination of Metallic Castings*

ASTM E165–02, *Test method for Liquid Penetrant Examination*

ASTM E186–98, *Heavy-Walled (2 to 4 ½-in. [51 to 114-mm]) Steel Castings*

ASTM E280–98, *Heavy-Walled (4 ½ to 12-in. [114 to 305-mm]) Steel Castings*

ASTM E446–98, *Steel castings Up to 2 in. [51 mm] in Thickness*

ASTM E562–02, *Test Method for Determining Volume Fraction by Systematic Manual Point Count*

ASTM E94–04, *Radiograph Examination*

ASTM G48–03, *Standard Test Method for Pitting and Crevice Corrosion Resistance of Stainless Steel and Related Alloys by Use of Ferric Chloride Solution*

BS 1868, *Specification for steel check valves (flanged and butt-welding ends) for the petroleum, petrochemical and allied industries*

BS 1873, *Specification for steel globe and globe stop and check valves (flanged and butt-welding ends) for the petroleum, petrochemical and allied industries*

BS EN 1226 6-1, *Industrial valves – Testing of metallic valves Part 1: Pressure tests, test procedures and acceptance criteria – Mandatory requirements*

BS EN 12266-2, *Industrial valves – Testing of metallic valves Part 2: Tests, test procedures and acceptance criteria – Supplementary requirements*

BS ISO 7121, *Steel Ball Valves for general purpose Industrial Applications*

EN 10204, *Metallic products Types of inspection documents*

ET-3000.00-1200-956-PCI-001, *Código de Cores – Pintura*

I-ET-3010.00-1200-955-P4X-001, *Welding*

I-ET-3010.00-1200-956-P4X-002, *General Painting*

I-ET-3010.00-1200-955-P4X-002, *Requirements for Welding Inspection*

IOGP S-562, *Supplementary Requirements to API Specification 6D Ball Valves*

IOGP S-611, *Supplementary Requirements to API 600 Steel Gate Valves and to API 603 CRA Gate Valves*

ISO 10434, *Bolted bonnet steel gate valves for the petroleum, petrochemical and allied industries*

ISO 10497, *Testing of valves – Fire type-testing requirements*

ISO 12944-9, *Paints and varnishes — Corrosion protection of steel structures by protective paint systems*

ISO 14313, *Petroleum and natural gas industries – Pipeline transportation systems – Pipeline valves*

ISO 15156 (all parts), *Petroleum and natural gas industries - Materials for use in H<sub>2</sub>S-containing environments in oil and gas production*

ISO 15761, *Steel gate, globe and check valves for sizes DN 100 and smaller, for the petroleum and natural gas industries*

ISO 15848-1, *Industrial valves - Measurement, test and qualification procedures for fugitive emissions – Part 1: Classification system and qualification procedures for type testing of valves*

ISO 15848-2, *Industrial valves - Measurement, test and qualification procedures for fugitive emissions – Part 2: Production acceptance test of valves*

ISO 17292, *Metal ball valves for petroleum, petrochemical and allied industries*

ISO 5208, *Industrial valves – Pressure testing of metallic valves*

MSS SP-25, *Standard Marking System for Valves, Fittings, Flanges and Unions*

MSS SP-45, *Bypass and drain connections*

MSS SP-55, *Quality Standard for Steel Castings for Valves, Flanges, Fittings, and Other Piping Components - Visual Method for Evaluation of Surface Irregularities*

MSS SP-9, *Spot facing for bronze, iron and steel flanges*

MSS SP-91, *Guidelines for manual operation of valves*

NBR 15827, *Industrial Valves for Installations of Exploration, Production, Refining and Transport of Petroleum Products - Requirements for Design and Prototype Test*

NORSOK 630 Rev. 3/2004, *Material Datasheet for Piping*

### **A.3. TERMS AND DEFINITIONS**

For the purposes of this document, the following terms and definitions apply:

#### **A.3.1. BI-DIRECTIONAL VALVE:**

Valve designed for blocking the fluid in both downstream and upstream directions.

#### **A.3.2. CASTING CRITICAL AREAS:**

The regions of castings determined by manufacturer engineering, based on valve parts highly stressed by manufacturing process and as determined by finite elements under the maximum process/operating conditions.

#### **A.3.3. DOUBLE-BLOCK-AND-BLEED VALVE – DBB:**

Single valve with two seating surfaces that, in the closed position, provides a seal against pressure from both ends of the valve with a means of venting/bleeding the cavity between the seating surfaces.

#### **A.3.4. DOUBLE-ISOLATION-AND-BLEED VALVE - DIB:**

Single valve with two seating surfaces, each of which, in the closed position, provides a seal against pressure from a single source, with a means of venting/bleeding the cavity between the seating surfaces.

DIB-1 valves have both seats bidirectional. Vent or relief of valve cavity shall be obtained by use of an external relief valve.

DIB-2 valves have one seat unidirectional and one seat bidirectional. Further details are listed in A.7.1.4.

#### **A.3.5. THROUGH-CONDUIT VALVE:**

Valve with an uninterrupted and continuous cylindrical opening. Consequently, there are no cavities or large gaps in the bore between seats and body closures or between seats and obturator.

#### **A.3.6. FULL-BORE VALVE:**

Valve with an unobstructed opening, not smaller than the internal bore of the end connections.

#### **A.3.7. SEATING SURFACES:**

Contact surfaces of the obturator and seat which ensure valve sealing.

#### **A.3.8. PRESSURE CLASS:**

Numerical pressure design class, expressed in accordance with either the nominal pressure (PN) class or the ASME rating class.

#### **A.3.9. PITTING RESISTANCE EQUIVALENT NUMBER (PREN):**

Empiric Mathematical Formula that correlates pitting corrosion resistance with the amounts alloying elements in the steel that contribute to increase this resistance. For duplex steels it shall be calculated as follows:

$$\text{PREN} = \%Cr + 3,3 \times (\%Mo + 0,5 \times \%W) + 16 \times \%N.$$

#### **A.3.10. PILOT CASTING:**

For the customer purpose, any casting that is the first of its model or of a new or modified project, using the same casting procedure (same casting) as the ones it represents.

#### **A.3.11. CASTING:**

Any component of a valve, made by casting.

#### **A.3.12. NOMINAL TORQUE OF OPERATION – TNO:**

It is the actual value of torque needed to operate the valve, under any operation condition. This value shall be presented in the marking (plate) of the valve.

#### **A.3.13. MAXIMUM TORQUE OF OPERATION – TMO:**

It is the maximum value of torque that may be applied on the valve, without damaging the override mechanism (i.e.: no plastic deformation on the drive train). This value of torque shall present the safety margin of the actuator, to be applied only under special situation such as a contingency (e.g.: when the valve is not opening / closing with TNO value). Typically, TMO is 150% TNO.

#### **A.3.14. MAXIMUM ALLOWABLE TORQUE – TMA:**

It is the value of torque that may be applied on the valve, after that it shall start damaging the override mechanism (i.e.: plastic deformation on the drive train).

### **A.4. SYMBOLS AND ABBREVIATED TERMS**

For the purposes of this document, the following symbols and abbreviated terms apply:

ADV	anti-columning deluge valve
CRA	corrosion resistance alloy
DBB	double block and bleed
DIB-1	double isolation and bleed. Both seats bidirectional (DPE)
DIB-2	double isolation and bleed. One seat uni-directional (SPE or SR) and one seat bidirectional (DPE)
DN	nominal size
DPE	double piston effect
EPC	engineering, procurement and construction
FAT	factory acceptance test
HIPPS	high integrity pressure protection system
HP	high pressure
HVOF	high velocity oxygen fuel
ID	internal diameter
ITP	inspection and testing plan
LCF	contractual list of supply
LP	low pressure
LPI	liquid penetrant inspection
LTD	designation for limited class valves per ASME B16.34
MWP	maximum working pressure

NDT	nondestructive testing
NPS	nominal pipe size
PFDF	probability of failure on demand
PST	partial stroke testing
PVT	performance verification test
QSL	quality specification level
RGD	rapid gas decompression
SDV	shut down valve
SIF	safety instrumented function
SIL	safety integrity level
SIP	shut in pressure
SPE	single piston effect
SR	self-relief
TMA	maximum allowable torque
TMO	maximum torque of operation
TNO	nominal torque of operation
UNS	unified numbering system
VAC	axial control valve
VAG	needle valve
VAX	axial valve
VBO	butterfly valve
VCI	volatile corrosion inhibitor
VDE	double ball valve
VDI	diaphragm valve
VDS	valve datasheet
VES	ball valve
VGA	gate valve
VGL	globe valve
VMA	plug valve
VRE	check valve
VSL	valve specification level
WPS	welding procedure specifications
WPQR	welding performance qualification record

## A.5. VALVE SELECTION GUIDE

### A.5.1. INTRODUCTION

- A.5.1.1. In this item is presented general information, such as a guide of how shall be conducted the engineering process to select a valve for use in the Project and/or specific application.
- A.5.1.2. The indication of all valves shall be driven by the definition of Valve Specification Level (VSL), which regulates the specification of an adequate valve for a certain application, taking into account the criticality foreseen in the application/use of the valve.
- A.5.1.3. The VSL classification will provide specific requirements for four valve specification levels (VSLs): VSL-1, VSL-2, VSL-3, VSL-4. These four VSL designations define different levels of technical / quality requirements.
- A.5.1.4. The determination of the VSL is obtained by the classification rules stated on item A.5.2.
- A.5.1.5. All VDS presented herein are formulated according its specific VSL indication. Design premises, such as materials (metallic / non-metallic), configurations, tests and design validation are based on the criticality foreseen in the application/use of the valve and defined by the specific VSL.
- A.5.1.6. For any given VSL, there is a set of requirements associated with it (item A.5.3).
- A.5.1.7. The manufacturer of the valve shall attend all requirements listed in the VDS, including the specific requirements of VSL.
- A.5.1.8. It is possible to have more than one type of valve (e.g.: ball, gate, etc.) with the same VSL number, and possibly both types would be able to attend a certain application. In this case, it shall be conducted by the Project and/or user an evaluation of the valve features associated with the foreseen application, and so define the type of valve that shall be specified in the Project and/or specific application.
- A.5.1.9. The valve's features are presented in item A.5.4, and allows an adequate understanding about which type of valve is more suitable for the intended application.

### A.5.2. VALVE SPECIFICATION LEVEL (VSL) - CLASSIFICATION

The VSL classification shall be taken according to premises indicated in this item. It shall be evaluated the following parameters by the Project and/or user:

Table A.2 describes this evaluation.

- a) Table A.2 describes this evaluation.
- b) Accumulated energy: it shall be verified the classification of accumulated energy associated with the use of the valve, as described in Table A.1.
- c) Demand: the expected number of cycles during the lifetime of the valve shall be taken into account when considering the VSL. The higher the number, the higher the VSL, as described in Table A.1.



Table A.1 – Classification of accumulated energy and high demand valves

<b>Accumulated Energy</b>	<b>High</b>	Valves of Pressure Class 600 and 900, NPS ≥ 6 Valves of Pressure Class 1500, 2500 and 10.000psi
	<b>Low</b>	Valves of Pressure Class 125, 150 and 300 Valves of Pressure Class 600 and 900, NPS ≤ 4
<b>High Demand</b>	Actuated Filter valves, Actuated XVs, Actuated molecular sieve valve. In general, actuated valves that operate more than once a month.	

Table A.2 – Valve Specification Level (VSL) classification

<b>Safety Valves</b>	<b>Application</b>		<b>Level</b>	
		HIPPS, SDV Platform limits		VSL-4
	SDV, BDV, L/R PIG (Note 1)		VSL-3	
	ADV, ADV Block		VSL-2	
<b>Other valves</b>	<b>Service (Note 2)</b>	<b>Accumulated Energy</b>	<b>High Demand</b>	
			<b>Yes</b>	<b>No</b>
	Hydrocarbon Hot water Flammable Steam Toxic	High	VSL-3	VSL-2
		Low		
	Other services	High	VSL-2	VSL-2
		Low		VSL-1
Note 1 – This table is not applicable for valves in tubing specifications. Note 2 – See below the fluids belonging to each service: <ul style="list-style-type: none"> <li>- Hydrocarbon / Flammable / Toxic: AM, CI, CI2, CN, CNI, D, DF, DFC, DOH, F, FG, G, GL, H, HBG, IGN, JF, OL, P, PC, PCG, PLD, TR;</li> <li>- Hot water: HWP;</li> <li>- Steam: S;</li> <li>- Other services: ADW, AO, BG, BR, BWG, BWH, CHW, CV, DA, DO, DTH, DW, EG, FL, FLC, FP, FW, GW, HF, HBG, HWU, IA, IG, IN, IW, IWC, PCW, PW, PWH, SA, SC, SFW, SN, SP, STA, SW, TC, TL, W, WW.</li> </ul>				

### A.5.3. VALVE SPECIFICATION LEVEL (VSL) - REQUIREMENTS

A.5.3.1. Each VSL classification inputs to the valve design a basic information about which API 6D - Quality Specification Level (QSL) shall be fulfilled, plus a sort of specific requirements (mandatory).

A.5.3.2. The QSL classification and requirements are according to API 6D: QSL-1, QSL-2, QSL-3 or QSL-4. All requirements listed in API 6D Annex I shall be attended according the respective QSL related to the VSL.

A.5.3.3. The QSL refers to specific requirements for NDT, pressure testing and documentation of the valve.

A.5.3.4. The VSL requirements shall be as described in Table A.3:

Table A.3 – Valve Specification Level (VSL) requirements

VSL Requirements	VSL-1	VSL-2 (not for hydrocarbon)	VSL-2 (with hydrocarbon)	VSL-3	VSL-4
<b>QSL</b> (According API 6D)	QSL-2	QSL-2	QSL-3	QSL-3	QSL-4
<b>PSL</b> (According API 6A)	NA	PSL-3 or PSL-3G as applicable	PSL-3 or PSL-3G as applicable	PSL-4	PSL-4
<b>Fugitive Emissions Design</b> (According item A.6.1.6)	No	No (Note 2)	Yes / No (Note 1)	Yes / No (Note 1)	Yes / No (Note 1)
<b>Fire Resistant</b> (According item A.6.1.3.3)	No (Note 2)	Yes / No (Note 3)	Yes / No (Note 3)	Yes / No (Note 4)	Yes
<b>Design Validation</b> (According item A.9.2)	No	Design analytical approval		Design validation test approval (PVT)	
<b>SIL Capable</b> (According item A.6.1.7)	No	No	No	No	Yes / No (Note 5)

Note 1 – The valve design shall be fugitive emissions approved if the valve will be specified for use in a process pipe that fluid contains volatile organic compounds (e.g.: benzene), and its emissions to environment are limited by a reglementary law.

Note 2 – If fire resistant requirement is requested by the Project, it shall be considered the use of a VSL-2 valve.

Note 3 – Indication of fire-resistant valve shall be taken according design premises.

Note 4 – SDV, BDV, ADV valves and valves certified for fugitive emissions shall be fire tested. For other valves, indication of fire-tested valve shall be taken according to design premises.

Note 5 – SIL capable applies only for HIPPS valve.

#### A.5.4. VALVE FEATURES AND TYPICAL APLICATIONS

A.5.4.1. For each type of valve, Table A.4 presents a summary of valve features and typical applications.

Table A.4 - Valve features and typical applications

Features	Ball			Gate			Check			Globe			Butterfly			Axial	Plug	Needle	Diaphragm
	Soft	Metal to Metal	Rising Stem (Metal to Metal)	Solid Wedge	Expanding	Slab	Piston	Dual Plate	Swing	Axial (Non-slam)	Chamber Disc	Category A (concentric)	Category B (bi-offset)	Category B (tri-offset)					
Manual operator design (eg.: wrench, handwheel gearbox)	A	A	A	A	A	A	N/A	N/A	N/A	A	A	A	A	A	A	A	A	N/A	
Actuated design (e.g.: hydraulic, electric, pneumatic)	A	A	A	A	A	A	N/A	N/A	N/A	A	A	A	A	A	A	A	N/A	A	
Soft seated design	Yes	No	N/A	No	A	No	No	A	No	No	No	Yes	No	No	Yes	Yes	No	Yes	
Metal to Metal seat design	No	Yes	Yes	Yes	A	Yes	Yes	A	Yes	A	Yes	No	No	Yes	No	No	Yes	No	
Piggable	Yes	Yes	No	No	Yes	Yes	No	N/A	N/A	No	No	No	No	No	No	No	No	No	
Bidirectional	Yes	Yes	No	Yes	Yes	Yes	No	No	No	No	No	No	No	No	Yes	Yes	No	No	
Double block and bleed (i.e.: DBB)	A	A	No	No	A	No	No	No	No	No	No	No	No	No	No	A	No	No	
Double Isolation and bleed (i.e.: DIB-1, DIB-2)	A	A	No	No	No	No	No	No	No	No	No	No	No	No	No	No	No	No	
Fire tested design	A	A	Yes	N/A	A	N/A	N/A	N/A	N/A	N/A	N/A	No	A	A	A	A	N/A	No	
Fire safe design	N/A	N/A	N/A	A	N/A	A	A	A	A	A	A	No	N/A	N/A	N/A	N/A	A	No	
Fugitive emissions design	Yes	Yes	Yes	Yes	Yes	Yes	N/A	N/A	N/A	N/A	N/A	Yes	Yes	Yes	Yes	Yes	Yes	Yes	
Fit to control application	N/A	N/A	N/A	N/A	N/A	N/A	N/A	N/A	N/A	N/A	N/A	N/A	N/A	N/A	N/A	N/A	P	N/A	
Fit to abrasive service (solids in suspension)	N/A	P	ALT	N/A	N/A	ALT	N/A	N/A	N/A	N/A	N/A	N/A	N/A	ALT	N/A	N/A	N/A	N/A	
Fit to Safety Instrumented System (SIS) (eg.: HIPPS application)	N/R	P	N/R	N/R	N/R	N/R	N/R	N/R	N/R	N/R	N/R	N/R	N/R	N/R	N/R	N/R	N/R	N/R	
SIL capable design	N/A	A	N/A	N/A	N/A	N/A	N/A	N/A	N/A	N/A	N/A	N/A	N/A	N/A	N/A	N/A	N/A	N/A	
Fit to SDV Platform Limits	N/R	P	N/R	N/R	N/R	N/R	N/R	N/R	N/R	N/R	N/R	N/R	N/R	N/R	N/R	N/R	N/R	N/R	
Fit to SDV, BDV application (Hydrocarbon service)	N/R	A	N/R	N/R	N/R	A	N/R	N/R	N/R	N/R	N/R	N/R	N/R	A	N/R	N/R	N/R	N/R	
Fit to SDV, BDV application (Non-hydrocarbon service)	A	A	N/R	N/R	N/R	A	N/R	N/R	N/R	N/R	N/R	N/R	N/R	A	N/R	N/R	N/R	N/R	
Fit to L/R PIG application	N/R	A	N/R	N/R	N/R	N/R	N/R	N/R	N/R	N/R	N/R	N/R	N/R	N/R	N/R	N/R	N/R	N/R	
Fit to molecular sieve application	N/R	N/R	P	N/R	N/R	N/R	N/R	N/R	N/R	N/R	N/R	N/R	N/R	ALT	N/R	N/R	N/R	N/R	
Fit to ADV application	N/R	N/R	N/R	N/R	N/R	N/R	N/R	N/R	N/R	N/R	N/R	N/R	N/R	N/R	N/R	N/R	N/R	A	

Legend: A – Available; ALT – Alternative solution; P – Preferential solution; N/R – Not Recommended; N/A – Not Available

## A.6. GENERAL DESIGN REQUIREMENTS

### A.6.1. VALVE

#### A.6.1.1. GENERAL

A.6.1.1.1. Regarding documentation hierarchy, valve design shall be according to the Standard referenced in the VDS. In case of conflict between the requirements herein established and that Standard, the attendance of this document shall be considered as mandatory.

A.6.1.1.2. The valve design shall attend all quality, functional, materials, testing, and configuration requirements specified in the VDS.

A.6.1.1.3. The assembly of the valve / actuator shall meet all operating conditions, in any position of installation, without performance reduction. Unless clearly specified, it shall be able to operate under full rated condition, such as opening and closing at full differential pressure, according to the design pressure indicated in the VDS.

A.6.1.1.4. For a heavy weighted valve (Weight > 25 kg) or a valve with larger dimensions (L+W+H > 1500 mm), the corresponding design shall consider the use at least of four (4) lifting handles. The vertical line of the lifting points shall be left free to avoid interference with the drive system or actuator.

A.6.1.1.5. The manufacturer shall present all dimensional drawings of the valve and actuator, with a list of all parts and materials specifications.

A.6.1.1.6. The manufacturer shall present a list of required torques on the valve shaft, containing the following values of torque: Nominal Torque of Operation (TNO), Maximum Torque of Operation (TMO) and Maximum Allowable Torque (TMA), taking into account the pressure class of the valve and temperature limits.

Note: for gate and globe valves with manual actuation, TNO shall be according MSS SP-91; for ball valves, the TNO shall comply with API 6D; and for butterfly valves, the TNO shall be according to API 609.

A.6.1.1.7. The manufacturer shall inform in the documentation all design and/or operation constraints (e.g.: installation position, flow direction, flow rate, limits of pressure, temperature and metallic / non-metallic materials, etc.).

A.6.1.1.8. Valve ID (bore) shall be compatible with the ID of the pipes and accessories in which the valve is installed.

A.6.1.1.9. All metallic materials shall have a mill certification, with registers of chemical composition, mechanical properties and other standards requirements, besides the manufacturer batch identification.

A.6.1.1.10. For valve designs which allows retained pressure in body cavity (when valve is fully closed or fully open), plugs capable to mitigate risk of an accident under an eventual remotion shall be used. In this case, those ports shall be closed with plugs having a constructive configuration that allows pressure relieving to atmosphere (relief hole) during the beginning of plug remotion, serving as an alert to the operator about the remaining pressure inside the valve body. An example of this kind of configuration is showed as follows:

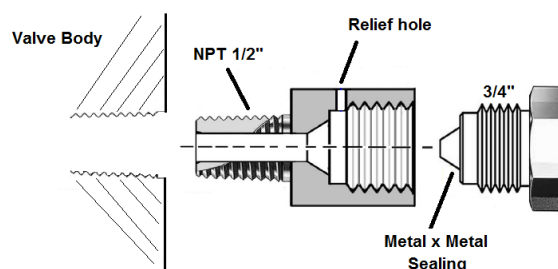

Figure A.1 – Example of use of drain and vent plug

A.6.1.1.11. For chlorinated seawater service, the maximum operating temperature for NAB valves shall be 75 °C according to ISO21457.

### A.6.1.2. MATERIAL CLASSES

A.6.1.2.1. The design of the valves shall attend one of the following classifications of material classes:

Table A.5 – Material classes

#	Material Class
C	Carbon Steel
A	Alloy Steel
S	Stainless Steel
D	Duplex Steel
N	Nickel Alloy
U	Uncommon materials

### A.6.1.3. BODY MATERIAL

A.6.1.3.1. The referred letter of the material class of the valve, shown on the first column of Table A.5, associated with the number indicated in the lines of Table A.6, gives the body material considered in the valve design. The combination of the letter and number shall be considered as a part of the valve code, according to description of valve code presented on item A.11.5.

Table A.6 – Body material, according to material class

Body Material	Material Class					
	C	A	S	D	N	U
	Carbon steel	Alloy steel	Stainless steel	Duplex steel	Nickel alloys	Uncommon materials
<b>1</b>	ASTM A105 or ASTM A216 WCB	ASTM A350 LF3 or ASTM 352 LC3	-	ASTM A995 Gr. 1B	Alloy 625 (UNS N06625)	Bronze
<b>2</b>	A350 LF2 CL1 or ASTM A352 LCC	ASTM A182 F5	ASTM A182 Gr. F316 or ASTM A351 Gr. CF8M	ASTM A182 Gr. F51 or ASTM A995 Gr. 4A	-	Ductile iron ASTM A536-65-45-12
<b>3</b>	ASTM A105 or ASTM A216 WCB + Organic Coating (Onshore use only)	ASTM A182 F11 CL2	ASTM A182 Gr. F317 or ASTM A351 Gr. CG8M	ASTM A182 Gr. F55 or ASTM A995 Gr 6A	-	ASTM B148 (UNS C95800)
<b>4</b>	ASTM A105 or ASTM A216 WCB + Organic Coating (Offshore)	ASTM A522 Type I	ASTM A182 Gr. F347 or ASTM A351 Gr. CF8C	-	-	Plastics
<b>5</b>	ASTM A105 or	ASTM A350 LF3 or	-	-	-	Gray Iron

Body Material	Material Class					
	C	A	S	D	N	U
	Carbon steel	Alloy steel	Stainless steel	Duplex steel	Nickel alloys	Uncommon materials
	ASTM A216 WCB + Full Clad Alloy 625 overlay (UNS N06625)	ASTM A352 LC3 + Full Clad Alloy 625 overlay (UNS N06625)				
<b>6</b>	ASTM A350 LF2 CL1 or ASTM A352 LCC + Full Clad Alloy 625 overlay (UNS N06625)	ASTM A522 Type I + Full Clad Alloy 625 overlay (UNS N06625)	-	-	-	Ductile iron + PFA liner ASTM A395 60-40-18
<b>7</b>	ASTM A694 F65 <sup>a</sup>	-	-	-	-	-
<b>8</b>	ASTM A216 WCB + PTFE / PFA					

<sup>a</sup> See A.6.1.3.3.

A.6.1.3.2. The use of forgings or castings for the body material shall follow the following classification according to the VSL of the valve, and indicated in the VDS:

Table A.7 – Process fabrication for body materials according to VSL

VSL	Pressure Class						
	150	300	600	900	1500	2500	10000
VSL-1	Forging or Casting				Forging (Note 1)		
VSL-2	Forging or Casting				Forging (Note 1)		
VSL-3	Forging (Note 1)						
VSL-4	Forging (Note 1)						

Note 1 - Except for axial valves (VAX, VAC) and Triple Offset Butterfly valves made of NIAIBr (UNS C95800), for which casting is acceptable.

A.6.1.3.3. ASTM A694 forgings shall comply with MDS IX-124 of IOGP S-563 and following modifications:

- A.6.1.3.3.1. Acceptance criteria for impact testing on full-size specimens shall be 40 J (average of three specimens) and 34 J minimum;
- A.6.1.3.3.2. Mechanical test specimens shall be taken from mid-thickness and mid-length of the test forging;
- A.6.1.3.3.3. Test forging shall be at least the same thickness of production forging;
- A.6.1.3.3.4. For clad valves ultrasonic testing shall be applied after cladding to all forgings. The testing shall be carried out using both compression and shear wave (normal and angle beam) techniques as per ASTM A388 and dedicated procedure with scanning plan. Supplementary requirements S1 shall apply. Acceptance criteria shall be as follows:
  - A.6.1.3.3.5. No single indication equal to or exceeding reference distance amplitude curve is allowed.
  - A.6.1.3.3.6. All indication with an echo greater than 25% of the reference will be deemed relevant and shall be investigated.
  - A.6.1.3.3.7. No multiple indications exceeding 50% of reference distance amplitude curve is allowed. Multiple

indications are defined as two or more indications (each exceeding 50% of the reference distance amplitude curve) within 13 mm of each other in any direction.

#### **A.6.1.4. FIRE TESTED VALVES**

A.6.1.4.1. In order to obtain indication that the valve design shall be fire tested type, it shall be fulfilled all requirements listed in DR-ENGP-I-1.3, such as the execution of the “Risk Assessment and Safety Studies” (item 5 of DR-ENGP-I-1.3) and the “Consequence Analysis - (fire propagation, gas dispersion, explosion, etc.)”.

A.6.1.4.2. Whenever specified in the VDS that the valve shall be fire tested, its design shall be submitted to a certification by testing a prototype according to ISO 10497, API 6FA or API 607 (except 4<sup>th</sup> edition).

A.6.1.4.3. The manufacturer shall present to PETROBRAS the correspondent certificate and the valve shall be marked as described on item A.6.1.10.

A.6.1.4.4. The design of the seals on seats/body and stem areas shall consider mandatory the use of a metallic element or an element made by graphite, to guarantee the attendance of the fire testing requirement. This element shall be installed on each leakage path of the valve.

#### **A.6.1.5. FIRE SAFE VALVES**

A.6.1.5.1. In order to obtain indication that a valve design shall be fire safe type, it shall be fulfilled all requirements listed in DR-ENGP-I-1.3, such as the execution of the “Risk Assessment and Safety Studies” (item 5 of DR-ENGP-I-1.3) and the “Consequence Analysis - (fire propagation, gas dispersion, explosion, etc.)”.

A.6.1.5.2. Whenever specified in the VDS that the valve shall be fire safe, its design shall contain material specification applying materials that are capable of withstanding exposure to fire without failure.

A.6.1.5.3. The fire safe design does not require valve certification, but it shall guarantee that the valve design is resistant to a fire scenario.

A.6.1.5.4. The design of the seals on seats/body and stem areas shall consider mandatory the use only of a metallic element or an element made by graphite, to guarantee the attendance of the fire safe requirement.

#### **A.6.1.6. FUGITIVE EMISSIONS**

A.6.1.6.1. In order to prevent a failure on a valve (e.g.: leaking toxic fluid to external environment), that could contribute to the minimize safety to personnel, installation and/or environment, some valves shall be designed to be fugitive emissions approved. This is applicable to all valves with one of the following services: DO, DOH, FG, GL, P or PC.

A.6.1.6.2. Whenever specified in the VDS that the valve shall be fugitive emission approved, its design shall be certified according to ISO 15848 Part 1, by prototype approval to confirm that an adequate design of seals (on body joints and stem) is provided.

A.6.1.6.3. The manufacturer shall prepare specific Performance Verification Test (PVT) procedure, according to ISO 15848 Part 1, and submit for PETROBRAS approval.

A.6.1.6.4. The manufacturer shall provide the certificate of approval containing information about the design “Performance Class” according to ISO 15848 Part 1. Information about “Tightness Class”, “Endurance Class”, and “Temperature Class” shall be presented in detail.

A.6.1.6.5. The “Tightness Class” shall be according BH.

Table A.8 – Tightness class for stem seals - fugitive emissions (ref.: ISO 15848 Part 1)

Class	Measured leak rate (mass flow)	Measured leak rate (mass flow)	Measured leak rate (volumetric flow)	Remarks
	mg.s <sup>-1</sup> .m <sup>-1</sup> stem perimeter (for information)	mg.s <sup>-1</sup> .m <sup>-1</sup> stem diameter through stem seal system	mbar.l.s <sup>-1</sup> per mm stem diameter through stem seal system	
AH <sup>1</sup>	≤ 10 <sup>-5</sup>	≤ 3,14.10 <sup>-8</sup>	≤ 1,78.10 <sup>-7</sup>	Typically achieved with bellow seals or equivalent stem (shaft) sealing system for quarter turn valves
BH <sup>2</sup>	≤ 10 <sup>-4</sup>	≤ 3,14.10 <sup>-7</sup>	≤ 1,78.10 <sup>-6</sup>	Typically achieved with PTFE based packings or elastomeric seals
CH <sup>2</sup>	≤ 10 <sup>-2</sup>	≤ 3,14.10 <sup>-5</sup>	≤ 1,78.10 <sup>-4</sup>	Typically achieved with flexible graphite based packings

<sup>1</sup> Expressed by the vacuum method as defined in ISO 15848 Part 1 - Annex A.  
<sup>2</sup> Measured by the total leak rate measurement method (vacuum or bagging) as defined in ISO 15848 Part 1 - Annex A.

Table A.9 – Tightness class for body seals - fugitive emissions (ref.: ISO 15848 Part 1)

Measured leakage (Body seals)	≤ 50 <sup>1</sup>
<sup>1</sup> Expressed in ppmv measured with the sniffing method as defined in ISO 15848 Part 1 - Annex B	

Table A.10 – Tightness class for stem (or shaft) seals with methane - fugitive emissions (ref.: ISO 15848 Part 1)

Class	Measured leakage ppmv (sniffing method according to ISO 15848 Part 1 - Annex B)
AM	≤ 50
BM	≤ 100
CM	≤ 500

<sup>1</sup> Expressed in ppmv measured with the sniffing method as defined in ISO 15848 Part 1 - Annex B

Table A.11 – Leakage from body seals with methane - fugitive emissions (ref.: ISO 15848 Part 1)

Measured leakage ppmv (sniffing method according to ISO 15848 Part 1 - Annex B)
≤ 50

A.6.1.6.6. The mechanical cycles shall be performed according to ISO 15848 Part 1, considering the following “Endurance Class” x VSL:

Table A.12 – Endurance class according VSL classification

Endurance Class (as defined in ISO 15848 Part 1 - Annex B)	VSL-1	VSL-2	VSL-3	VSL-4
	CC1 / CO1			

A.6.1.6.7. The “Temperature Class” shall be tRT. Nevertheless, seal materials shall be suitable for the entire temperature range informed in the valve data sheet.

Table A.13 – Temperature class of fugitive emissions (ref.: ISO 15848 Part 1)



(t-196 °C)	(t-46 °C)'	(tRT)	(t200 °C)	(t400 °C)
-196 °C	-46 °C	Room temperature, °C	200 °C	400 °C

#### A.6.1.7. SAFETY INTEGRITY LEVEL

A.6.1.7.1. The concept of Safety Integrity Level (SIL) shall be applied for valves dedicated to a HIPPS system.

A.6.1.7.2. The SIL is a representation of the required safety unavailability (average probability of failure on demand - PFD) of a safety instrumented function (SIF).

A.6.1.7.3. The SIL classification shall be as listed in Table A.14, where SIL 4 has the highest level of safety integrity, and SIL 1 has the lowest.

Table A.14 – SIL levels

SIL	PFD	Availability	Risk Reduction Factor
SIL 1	0,1 to 0,01	0,90 to 0,99	10 to 100
SIL 2	0,01 to 0,001	0,99 to 0,999	100 to 1000
SIL 3	0,001 to 0,0001	0,999 to 0,9999	1000 to 10.000
SIL 4	0,0001 to 0,00001	0,9999 to 0,99999	10.000 to 100.000

A.6.1.7.4. Whenever requested in the VDS, such as for HIPPS valve, the SIL to be considered in the design of the valve shall be SIL-3. The manufacturer shall present all documentation in order to certify that SIL 3 requirements were achieved for the valve design.

#### A.6.1.8. BOLTING

A.6.1.8.1. The Studs, bolts and nuts used in the body-closure and body-bonnet shall be according:

Table A.15 - studs, bolts and nuts material specification

Body Material	Studs / Bolts Material	Nuts	Coating
ASTM A105 ASTM A216 Gr. WCB	ASTM A193 Gr. B7	ASTM A194 Gr. 2H	According to item A.6.1.8.2
ASTM A350 Gr. LF2 CL1 ASTM A352 Gr. LCC	ASTM A320 Gr. L7	ASTM A194 Gr. 4L or 7L	
ASTM A350 Gr. LF3 CL1 ASTM A352 Gr. LC3	ASTM A193 Gr. B8M or ASTM A193 Gr. B8M CL2	ASTM A194 Gr. 8M	N/A
ASTM A182 Gr. F11 CL2 ASTM A217 Gr. WC6 ASTM A182 Gr. F5 ASTM A217 Gr. C5	ASTM A193 Gr. B16	ASTM A194 Gr. 7	According to item A.6.1.8.2

Body Material	Studs / Bolts Material	Nuts	Coating
ASTM A182 Gr. F316 ASTM A351 Gr. CF8M ASTM A182 Gr. F317 ASTM A351 Gr. CG8M ASTM A182 Gr. F347 ASTM A351 Gr. CF8C	ASTM A193 Gr. B8M or ASTM A193 Gr. B8M CL2	ASTM A194 Gr. 8M	N/A

A.6.1.8.2. Zn-Ni coating shall be applied to studs, bolts and nuts in lines with temperature up to 260°C. The studs, bolts and nuts shall be coated with zinc-nickel (Zn-Ni) according to ASTM B841, Class 1, Type B / E, Grade 5-8, with post-coating hydrogen embrittlement relief, according to ASTM B 849 and ASTM B 850; the maximum hardness for studs and bolts shall be according to standard material specification.

A.6.1.8.3. For studs and bolts according to ASTM A320 Gr L7, and the valve body material is ASTM A350 Gr LF2 CL 1 or ASTM A352 Gr LCC, it will be acceptable charpy impact testing at -45°C. If the valve body material is ASTM A350 Gr LF3 or ASTM A352 Gr LC3, it will be acceptable charpy impact testing at -60°C;

A.6.1.8.4. The studs used in the body-closure (ball, check and plug) and body-bonnet (gate and globe) shall be according to ASME B1.1, UNC-2A up to 25,40mm (1") and 8UN-2A, from 28,57mm (1 1/8") up, with standard hex nuts according to ASME B18.2.2, with a minimum of four. The length of the studs shall have minimum of one and maximum of three screw threads beyond the nut. For valves with DN 40 (1 1/2") and smaller, is allowed the use of bolts according to ASME B18.2.1. Alternatively, studs, bolts and nuts may be according metric units;

A.6.1.8.5. Valves subjected to fire type-testing shall be assembled with studs, bolts and nuts according Table A.15. For the cases not covered in Table A.15, the manufacturer shall properly specify bolting materials. In this case, this set shall be used for fire type-testing. As an alternative of ASTM A193 Gr B7, studs made of ASTM A193 Gr B16 may be used, considering coating requirements indicated in item A.6.1.8.2.

A.6.1.8.6. Studs, bolts and nuts made of austenitic stainless steel (e.g.: Type 316) shall not be used when exposed to wet marine atmosphere with maximum operating temperature above 60°C if. As an alternative, ASTM A193 Gr. B7 may be used.

**A.6.1.9. PAINTING**

A.6.1.9.1. If painting of the valve is contractual required, the manufacturer shall present for PETROBRAS approval the Painting Inspection Plan, according PETROBRAS's specification and approved by a Painting Inspector Level II;

A.6.1.9.2. It shall be documented all painting inspection registers, and submitted for PETROBRAS;

A.6.1.9.3. The color to be applied on the valves shall according to DR-ENGP-M-I-1.15.

A.6.1.9.4. Coating systems specified for offshore and coastal applications shall be selected in accordance with ISO 12944-9 corrosion category CX high durability and I-ET 3010.00-1200-956-P4X-002.

**A.6.1.10. MARKING AND NAMEPLATE**

A.6.1.10.1. All valves shall be marked in accordance with the requirements stated on the design Standard referenced in the VDS.

A.6.1.10.2. Each valve shall be provided with an austenitic stainless-steel nameplate securely affixed and so located that it is easily accessible. Rivet holes shall be drilled prior to hydrostatic shell test.

A.6.1.10.3. The nameplate shall present information in accordance with the requirements stated on the design Standard referenced in the respectively VDS, plus the additional data:

A.6.1.10.3.1. Indication about the VSL of the valve, such as: VSL-1, VSL-2, VSL3 or VSL-4.

A.6.1.10.3.2. Indication about fire tested design (when applicable).

A.6.1.10.3.3. Indication about fugitive emissions design (when applicable).

A.6.1.10.4. For trunnion mounted ball valves, despite of the separate identification plate requested by API 6D to indicate the direction of seats valves with one unidirectional seat and one bidirectional seat, each valve shall present a separate identification plate indicating the seat configuration, such as illustrated in Figure A.2.

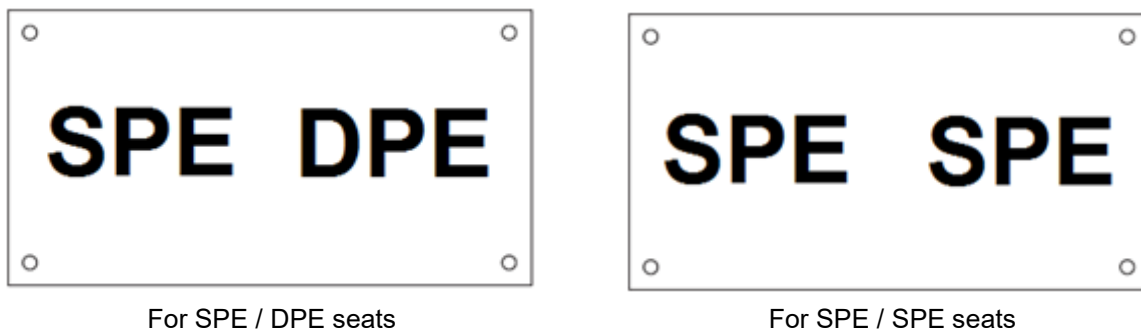

Figure A.2 – Example of nameplates with indication of seat configuration

A.6.1.10.5. Valves designed with unidirectional flow capability, i.e., flow occurs only in one direction, shall be marked with a flow direction arrow or with a separate identification plate fixed to the body, indicating the direction for which flow is permitted.

## A.6.2. ACTUATOR

### A.6.2.1. GENERAL

A.6.2.1.1. In general, all VDS contain technical specification considering manual actuated valves. The actuation for manual valves may be as a wrench, hand wheel or gearbox operator.

A.6.2.1.2. Other types of actuators, such as hydraulic, pneumatic or electric, may be considered by PETROBRAS to be used. In this case, the manufacturer shall design the valve and actuator considering also the specific datasheet.

A.6.2.1.3. When applicable (i.e.: control valve, SDV and BDV), the design of actuators shall consider the requirements stated in DR-ENGP-M-I-1.5.

A.6.2.1.4. When applicable, the actuator shall be equipped with a positioning indicator, in order to show correct and clearly the position of the valve (open or close). The position of a wrench or indicator shall be in the direction of the line/bore when the valve is open and be perpendicular to the line/bore when the valve is closed.

A.6.2.1.5. For gearbox operator, the connection between the valve body and the gearbox shall be vented so that any leakage from the stem cannot penetrate into the gearbox housing.

A.6.2.1.6. In case hydraulic actuator is considered, the manufacturer shall design it in order to have a maximum operating pressure (e.g.: opening under full differential pressure) of 90% of the nominal operating pressure.

A.6.2.1.7. The actuator shall be designed with a safety factor of 2 times the nominal torque during normal operation

condition (maximum available torque = 2 x nominal torque).

A.6.2.1.8. For hand wheel actuated valves, the hand wheel shall be designed to allow operation of the valve under full differential pressure. It shall also attend the requirements listed in MSS SP-91.

A.6.2.1.9. Levers and handwheels shall be in grade 316 stainless steel material.

### A.6.2.2. ACTUATOR TYPE

A.6.2.2.1. Unless otherwise specified, the actuator type shall be according:

Table A.16 – Actuators type

Type	Pressure Class	Use of Gearbox x DN(NPS) ≥
Gate	150	300 (12)
	300	250 (10)
	600	150 (6)
	900	100 (4)
	1500, 2500	80 (3)
Globe	150, 300	200 (8)
	600, 900	100 (4)
	1500, 2500	80 (3)
Ball	150, 300	150 (6)
	600, 900	100 (4)
	1500, 2500	50 (2)
Butterfly Category A (concentric)	CWP and 150	250 (10)
Butterfly Category B (bi-eccentric / triple-eccentric)	150 and 300	200 (8)
	600	160 (6)
Plug	150, 300	150 (6)
	600, 900	100 (4)

## A.7. SPECIFIC DESIGN REQUIREMENTS

### A.7.1. BALL VALVE

#### A.7.1.1. DESIGN REQUIREMENTS

A.7.1.1.1. The valve shall be designed to operate and seal, according to design premises, under the following conditions:

- a) high pressure, equivalent to MWP, being able to operate and seal with high and low differential pressure.

b) low pressure, equivalent to LP of specific QSL requirement, being able to operate and seal with a low differential pressure.

A.7.1.1.2. The type of the seats, regarding SPE or DPE, shall be used in the assembly of the valve in order to guarantee the isolation valve configuration specified in the VDS (i.e.: DBB, DIB-1 or DIB-2). Any deviation shall be submitted for PETROBRAS approval.

A.7.1.1.3. All sealings specified for the body construction shall be bi-directional, and no visible leakage shall be considered to external environment.

A.7.1.1.4. The sealing type of the valve, regarding metal-to-metal or soft sealing, shall be according to the indication in the VDS. Any deviation shall be submitted for PETROBRAS approval.

A.7.1.1.5. A metal-to-metal seated ball valve consists exclusively in use of a metal-to-metal sealing between seats and ball, without the use of a non-metallic insert.

A.7.1.1.6. A soft seated ball valve consists in use of a non-metallic insert to guarantee its sealing performance. In this case, the seat insert design and its groove shall be designed in order to prevent extrusion under all operation conditions.

A.7.1.1.7. Whenever specified in the VDS, the manufacturer shall attend to the metallic coating specified for the sealing surfaces, such as in the body, bonnet, ball, seats, etc. In this case, the manufacturer shall attend the applicable requirements listed on items A.7.1.7.3 and A.8.

A.7.1.1.8. Whenever specified in the VDS, the manufacturer shall attend to the hard coating specified for the sealing surfaces, such as in the ball and seats. In this case, the manufacturer shall attend the applicable requirements listed on items A.7.1.7.4 and A.8.2.2.

A.7.1.1.9. Whenever specified in the VDS, the manufacturer shall attend to the organic coating specified. In this case, the manufacturer shall attend the applicable requirements listed on item A.8.2.2.4.

A.7.1.1.10. Cancelled.

A.7.1.1.11. For trunnion ball valves type DIB-1, or when requested in the VDS, it shall be provided with an automatic cavity-pressure relief. In this case, it shall be considered the use of a block valve before the cavity-relief valve.

A.7.1.1.12. Cancelled.

A.7.1.1.13. The ball shall be full bore type, cylindrical and solid as shown in Figure A.3. Reduced bore may be used only if approved by Petrobras.

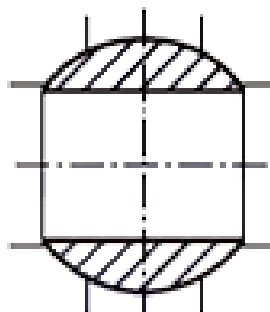

Figure A.3 – Ball type

#### A.7.1.2. DESIGN STANDARD

A.7.1.2.1. The following standards shall apply to the design of ball valves:

Table A.17 – Design Standards for ball valves

Description	Body / Closure Material							
	Casting or Forging				Forging			
	Flanged <sup>b</sup>				Socket weld <sup>c</sup>		Butt weld <sup>c</sup>	Flanged
<b>DN <sup>a</sup> (NPS)</b>	50 up to 900 (2 up to 36)	50 up to 600 (2 up to 24)	50 up to 400 (2 up to 16)	50 up to 300 (2 up to 12)	15 up to 40 (1/2 up to 1 1/2)			
<b>Class</b>	150, 300 600	900	1500	2500	800	1500	2500	150, 300, 600 900, 1500, 2500
<b>Standard</b>	API 6D / IOGP S-562 <sup>d</sup>				ISO 17292	ASME B 16.34 LTD		API 6D

<sup>a</sup> DN = Nominal diameter, in millimeters (mm).

<sup>b</sup> For DN > standard diameter, face to face shall be by agreement between manufacturer and PETROBRAS. The design shall be according to ASME B16.34.

<sup>c</sup> The design of the valve shall consider the use of a nipple with extension of 100,00 millimeters.

<sup>d</sup> As applicable. See also A.7.1.8.

### A.7.1.3. MOUNTING TYPE

A.7.1.3.1. The design of metallic ball valves (metal-to-metal or soft seated) shall attend the following characteristic regarding mounting:

Table A.18 – Mounting type for ball valves

DN (NPS)	150   300	600   800   900	1500   2500
15 (1/2) up to 40 (1 1/2)	Floating		Trunnion
50 (2) up to 100 (4)	Floating <sup>a, b</sup>	Trunnion <sup>c</sup>	
150 (6) and above	Trunnion		

<sup>a</sup> Single ball valves used for LIT / LG block shall be trunnion-mounted, DIB-2 configuration.  
<sup>b</sup> Double ball valves NPS 3 and 4, classes 150 and 300, shall be trunnion-mounted.  
<sup>c</sup> Double ball valves NPS 2, classes 600 and 900, shall be floating.

### A.7.1.4. ISOLATION VALVE CONFIGURATION

A.7.1.4.1. SINGLE PISTON EFFECT (SPE) OR SELF-RELIEF (SR) SEAT:

A.7.1.4.1.1. A SPE/SR assembly seat provides sealing only when differential pressure is higher from outside of the valve. When the SPE assembly seat faces higher differential pressure from inside of the valve (cavity), it occurs self-relieving.

A.7.1.4.1.2. A SPE/SR assembly seat may be provided on a metal-to-metal seat design or on a soft seated design.



A.7.1.4.1.3. Left side of Figure A.4 illustrates the sealing mechanism when pressure (or higher differential pressure) is applied from outside of the valve. The difference in the area (“D”) times the line pressure creates a piston effect force which pushes the seat against the ball surface resulting in a sealing between ball and seat.

A.7.1.4.1.4. Right side of Figure A.4 illustrates the relief mechanism when a higher differential pressure is applied from the cavity of the valve. When the pressure in the valve cavity reaches certain pressure (so that the total force from cavity pressure that act on the seat is higher than the force causing by the upstream pressure), the trapped pressure will have enough force to push the seat and relief the valve cavity pressure.

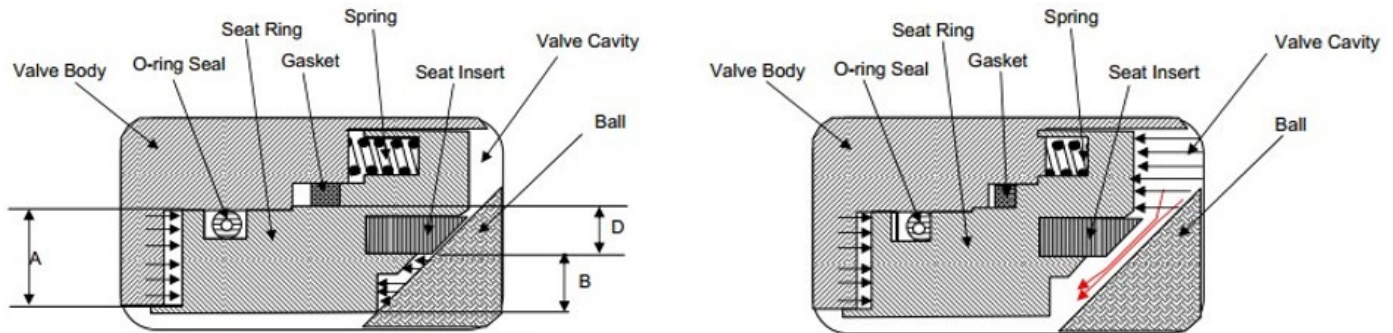

Figure A.4 – SPE/SR seat assembly mechanism (illustration on a soft ball valve)

A.7.1.4.2. DOUBLE PISTON EFFECT (DPE) SEAT:

A.7.1.4.2.1. A DPE assembly seat provides sealing on both directions, when differential pressure is higher from outside/inside of the valve.

A.7.1.4.2.2. A DPE assembly seat may be provided on a metal-to-metal seat design or on a soft seated design.

A.7.1.4.2.3. Left side of Figure A.5 illustrates the sealing mechanism when pressure (or higher differential pressure) is applied from outside of the valve. The difference in the area (“D”) times the line pressure creates a piston effect force which pushes the seat against the ball surface resulting in a sealing between ball and seat.

A.7.1.4.2.4. Right side of Figure A.5 illustrates the sealing mechanism when pressure (or differential pressure) is applied from the cavity of the valve. The difference in the area (“D”) times the cavity pressure creates a piston effect force which pushes the seat against the ball surface resulting in a sealing between ball and seat.

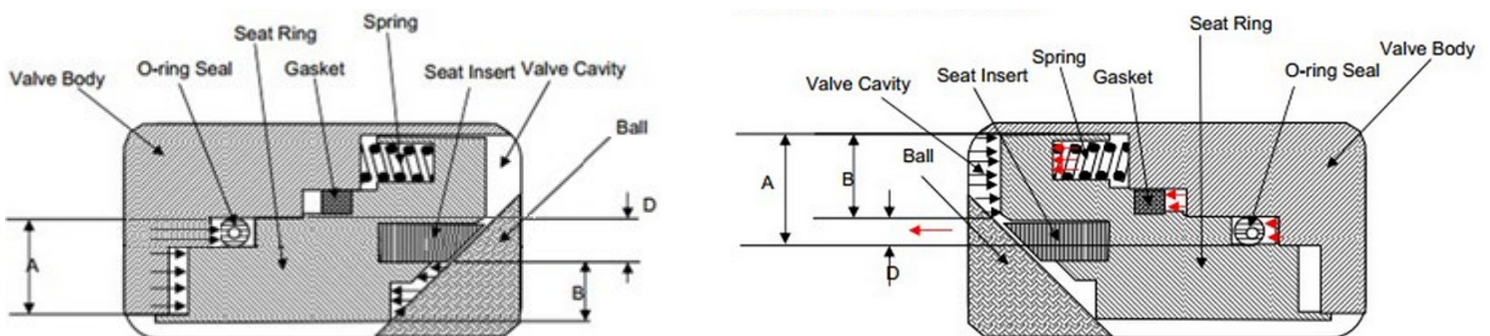

Figure A.5 – DPE seat assembly mechanism (illustration on a soft ball valve)

A.7.1.4.3. Whenever not specified in the VDS, the valve design shall consider as a standard isolation valve configuration the use of two unidirectional sealing seats, giving a characteristic of single piston effect (SPE) or self-relief (SR) on both seats.

A.7.1.4.4. In order to ensure adequate operational requirements, whenever specified in the VDS, the design of trunnion

ball valves (metal-to-metal or soft seated) may fulfill one or more of the following functions/features:

a) DOUBLE BLOCK AND BLEED (DBB):

The DBB feature of the valve is the ability to segregate two pressure sources and to bleed/vent pressure in the valve body between the two seats when the valve has the DBB feature. The DBB feature may be obtained by using SPE/SR or DPE seats.

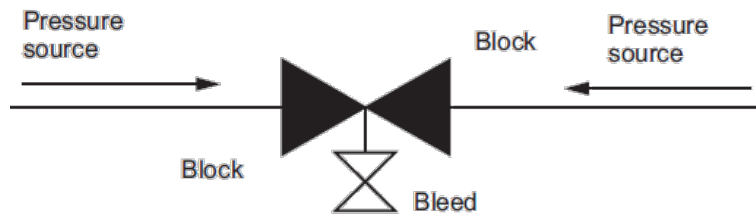

Figure A.6 – DBB feature (ref.: Double Block and Bleed - Type B of API 6D)

b) DOUBLE ISOLATION AND BLEED 1 (DIB-1):

The DIB-1 feature of the valve is the ability to provide two sealing elements to a single pressure source, and to bleed/vent between the two sealing elements. It shall be considered Upstream and Downstream as bidirectional sealing seat (DPE seats).

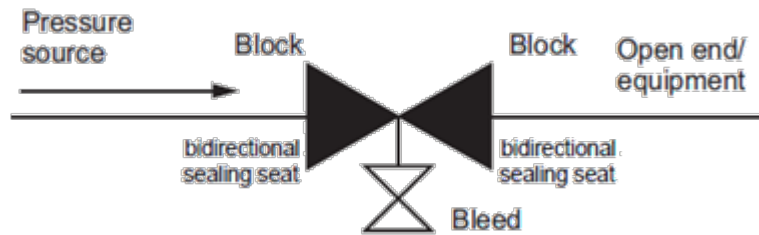

Figure A.7 – DIB-1 feature (ref.: Double Isolation and Bleed - Type B of API 6D)

Valves designed with a DIB-1 feature shall be provided with automatic cavity-pressure relief, unless otherwise agreed. In this case, it shall be attended all requirements described on API 6D (ref. item 5.5 of API6D).

c) DOUBLE ISOLATION AND BLEED 2 (DIB-2):

The DIB-2 feature of the valve is the ability to provide two sealing elements to a single pressure source, and to bleed/vent between the two sealing elements. It shall be considered the Upstream as unidirectional sealing seat (SPE seat) and downstream as bidirectional sealing seat (DPE seat).

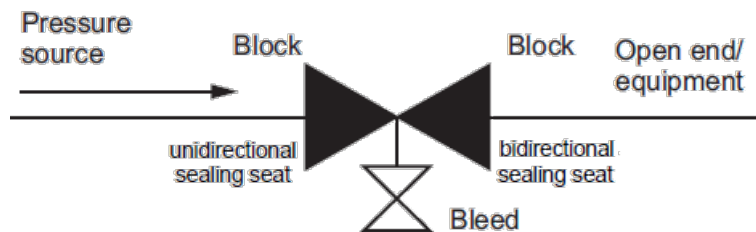

Figure A.8 – DIB-2 feature (ref.: Double Isolation and Bleed - Type B of API 6D)



All DIB-2 valves shall have a clear identification about seat sealing direction, by marking on a separate identification plate affixed to valve body both seats type of sealing (SPE or DPE).

The assembly of a DIB-2 valve on the line shall attend its preferred direction.

A.7.1.4.5. Depending on detailed design, indicated in the VDS, the valve may have an isolation valve configuration as follows:

Table A.19 – Isolation Valve Configuration for Ball Valves

Isolation valve configuration	Single Piston Effect (SPE) on both seats	Double Block and Bleed (DBB) Feature	Double Isolation and Bleed (DIB-2) Feature
1	Yes	No	No
2	Yes	Yes	No
3	No	Yes <sup>1</sup>	Yes
4	No	Yes <sup>2</sup>	Yes

<sup>1</sup> DBB feature applied in the closed position (only).  
<sup>2</sup> DBB feature applied in the opened and closed position (both).  
 Note: The use of DIB-1 feature has not been foreseen. Particular analyses of use may be conducted by Project team and/or an Operational Unit (UO).

#### A.7.1.5. NON-METALLIC SEALS

A.7.1.5.1. All non-metallic seals shall be suitable for the pressure, temperature and service conditions considered in this item.

A.7.1.5.2. The manufacturer of the valve shall guarantee together with your seals supplier(s) the attendance of the essential material requirements for the non-metallic seals, in order to ensure that the designed seal system works properly during the whole design life of the valve.

A.7.1.5.3. The VDS of soft seated ball valves indicates the material of the seat insert.

A.7.1.5.4. The use of certain seat insert material shall be based on the following classification:

Table A.20 – Non-metallic materials for seat insert seal design

Material	Pressure Class	Design Temp. (°C)	
		Minimum	Maximum
PTFE reinforced with 25% of Carbon	150, 300	-46	+150
Devlon V-API <sup>1</sup>	600, 900	-46	+120
PEEK Based <sup>2</sup>	600, 900, 1500, 2500	-46	+150

<sup>1</sup> The use of Devlon V-API is not allowed on valves applied on AM (amine) systems.  
<sup>2</sup> The use of PEEK is acceptable for pressure class 2500 only up to 120°C.

Note: The values listed in Table A.20 presents the limits of temperature that shall be applied in the valve design considering operational conditions of it.

A.7.1.5.5. For the design of th'e seats / stem seals, in metal-to-metal or soft seated ball valves, the VDS contains

indication about the non-metallic group material that shall be considered in the valve design.

A.7.1.5.6. The materials of each group are indicated in Table A.21, according to the following classification:

- Group A – Terpolymer of VF2, HFP e TFE with fluor content of ~ 67 - 70% or HNBR with %ACN between 36 and 40%. E.g.: Viton B (DuPont), Technoflon TN (Solvay Solexis);
- Group B – Ter- or Tetrapolymer of TFE, VF2 and PMVE with fluor content of ~ 62-68% or HNBR LT (%ACN between 36 and 40%) both with TR10 ≤ -30°C according to ASTM D1329. E.g.: Viton GLT (DuPont), Technoflon 855 (Solvay Solexis);
- Group C – Terpolymer of PP, TFE and VDF with higher resistance to bases or perfluoro elastomer (FFKM). e.g.: FKM Type 4- Aflas (Asashi Glass), BRE 7132 (Dyneon), FFKM- Kalrez, Chemraz, Technoflon PFR (Solvay Solexis);
- Group D – Terpolymer of PP, TFE and VDF with higher resistance to aromatic hydrocarbons or perfluoro elastomer (FFKM). e.g.: BRE 7132 (Dyneon), FFKM- Kalrez, Chemraz, Technoflon PFR (Solvay Solexis);
- Group E – Polytetrafluoroethylene (PTFE) based Chevron Packing or Polytetrafluoroethylene (PTFE) energized with a Co-Cr-Ni alloy UNS R30003 (Elgiloy) spring;
- Group F – Graphite 98% pure, Graphoil or a metallic seal.

Table A.21 – Seal groups materials

Seals Group	Application	Design Temp. <sup>1</sup>		Transient Temp. <sup>2</sup>		Seals Materials	Seals Design	RGD	Suitable for	Group Restrictions
		Min. (°C)	Max. (°C)	Min. (°C)	Max. (°C)					
Group A	Normal Temperature	0	+150	0	+170	HNBR FKM Type 2	O-ring Polypak Gasket	No	Water, Utility, Sweet hydrocarbon and Chemicals	Amines Steam Aromatic hydrocarbons <sup>4</sup>
Group B	Low Temperature	-30	+150	-46	+170	HNBR LT FKM Type 3	O-ring Polypak Gasket	Yes <sup>3</sup>	Sweet hydrocarbon (Gas)	Amines, Steam, Aromatic hydrocarbons <sup>4</sup>
Group C	Medium High Temperature	0	+210	0	+240	FKM Type 4 FKM Type 5 FFKM	O-ring Polypak Gasket	No	Amines, Amine based scavengers and Inhibitors, Steam	Aromatic hydrocarbons <sup>4</sup> , Xylene
Group D	Medium High Temperature + Aromatics	0	+210	0	+240	FKM Type 5 FFKM	O-ring Polypak Gasket	No	All	-
Group E <sup>5</sup>	Wide Range Service	-100	+200	-100	+240	PTFE based PTFE based + UNS R30003 (Elgiloy)	Chevron Seal <sup>6</sup> Lip Seal	N/A	All	-
Group F	High Temperature	-100	+500	-100	+500	Graphite 98% Pure Graphoil Metallic Seal	Gasket C-Ring	N/A	All	-

<sup>1</sup> Temperature range for use of non-metallic material (i.e.: seats / stem seals) in the valve design. It shall be considered for continuous service without reducing the seals' economic life or its sealing capability.

<sup>2</sup> Temperature range considered whether the seals may be exposed for a short period of time (transient temperature spike), under a static condition (without operation), with a possible leakage but without permanently damaging the sealing system.

<sup>3</sup> RGD according to ISO 23936-2 for valves of pressure class 300 or above.

<sup>4</sup> Hydrocarbons streams containing more than 25% aromatics.

<sup>5</sup> The use of Group E is acceptable in replacement of Groups A, B, C or D, as long as the design of the valve considers application of Alloy 625 overlay (partial clad) on all sealing areas.

<sup>6</sup> Use of Chevron packing shall be combined with anti-extrusion PEEK rings.

A.7.1.5.7. As a reference, the use of each group seal is based to the following fluid classes & temperature ranges:

Table A.22 – Indication of groups of seals according to fluid class and temperature range

Fluid Class	Temperature Range				
	Normal (0°C to +150°C)	Low (-30°C to +150°C)	Medium High (0°C to +210°C)	Wide Range (-100°C to +200°C)	High (-100°C to +500°C)
Utility	Group A	-	-	-	-
Water	Group A	-	-	-	-
Hot Water	-	-	Group C	-	-
Steam	Group C	-	Group C	-	-
Sweet Hydrocarbon <sup>1</sup>	Group A	Group B	Group C	-	-
Sour Hydrocarbon <sup>2</sup>	Group C	Group E	Group C	Group E	Group F
Aromatic Hydrocarbon <sup>3</sup>	Group D	Group E	Group D	Group E	Group F
Chemicals <sup>4</sup>	Group A	-	Group C	-	-
High CO <sub>2</sub> content <sup>5</sup>	-	-	-	Group E	-
Amine (MEA) <sup>6</sup>	Group C	-	Group C	-	-

<sup>1</sup> Hydrocarbon streams containing less than 1% H<sub>2</sub>S (10.000 ppm).

<sup>2</sup> Hydrocarbon streams containing more than 1% H<sub>2</sub>S (10.000 ppm). Qualification and production testing of elastomers and thermoplastics shall be performed in accordance with Norsok M-710 or ISO 23936 Parts 1 and 2, qualifying the materials for sour service for the temperature range specified valve datasheet.

<sup>3</sup> Hydrocarbons streams containing more than 25% aromatics.

<sup>4</sup> It shall be considered the use of Group A for all chemicals typically used in a production facility (e.g.: inhibitors, scavengers, etc.), and Group D for amine-based chemicals or xylene.

<sup>5</sup> Hydrocarbon streams containing CO<sub>2</sub> with more than 10 mol%.

<sup>6</sup> Monoethanolamine.

A.7.1.5.8. For the indication of a valve configuration, it shall be considered the following classification as a part of the valve code, according to description of valve code presented on item A.11.5:

Table A.23 – Seals group classification into valve code

Seals Group	Soft	Metal x Metal
<b>A or B</b>	1	5
<b>C</b>	2	6
<b>D or E</b>	3	7
<b>F</b>	N/A	8
<b>Fugitive Emissions</b>	4	9

A.7.1.5.9. The housing design of elastomeric O-rings shall prevent risk of extrusion by use of thermoplastic back-up rings on both sides (PEEK or reinforced PTFE) for valves in piping class 900 and above.

#### A.7.1.6. TYPICAL CONFIGURATIONS

A.7.1.6.1. This item presents typical configurations for ball valves, as a result of combinations of materials and features. The configurations herein listed are considered to create a specific VDS.

A.7.1.6.2. The referred number of the typical configuration of the valve, shown on the first column of Table A.25 and Table A.26, shall be considered as a part of the valve code, according item A.11.5.

##### A.7.1.6.3. BALL VALVES UP TO NPS 1 1/2 (“FORGED” VALVES)

A.7.1.6.3.1. The design of ball valves up to NPS 1 1/2 (“Forged” valves) shall consider the use of a nipple with extension of 100,00 millimeters.

A.7.1.6.3.2. For the indication of the nipple considered in the valve configuration, it shall be considered the following classification as a part of the valve code, according to description of valve code presented on item A.11.5.

Table A.24 – Nipple classification into valve code

SCH	Pressure Class		
	800 <sup>1</sup>	1500	2500
<b>40S</b>	801	1501	2501
<b>80</b>	802	1502	2502
<b>160</b>	803	1503	2503
<b>XXS</b>	804	1504	2504
<b>40S</b>	805	1505	2505
<b>80</b>	806	1506	2506
<b>160</b>	807	1507	2507
<b>XXS</b>	808	1508	2508

<sup>1</sup> Code 800 is used for screwed ended connections.

A.7.1.6.3.3. The following basic configurations shall be considered in the design of ball valves up to NPS 1 1/2 (“Forged” valves):

Table A.25 – Typical configurations for ball metallic valves up to NPS 1 1/2 (“Forged” Valves)

Config. #	Sealing Type	Pressure Class	Seat Insert Material	Stem Seal Material	Fire Tested	End Connection	Seats Configuration	DBB	VSL	Fugitive Emission		
00	Soft	150, 300	PTFE + 25%C	Group B	Yes	Flanged	N/A	No	1, 2	No		
		600, 900	PEEK				SPE x SPE					
		1500, 2500										
01	Soft	800	PTFE + 25%C	Group B	Yes	SW, SE	N/A	No	1, 2, 3		No	
02			PTFE + 25%C	Group C, E								
03			PEEK	Group B								
04			PEEK	Group C, E								
05			Metal to Metal	N/A								Group D, E
06	Soft	1500	PEEK	Group B	Yes	SW	SPE x SPE	No	1, 2, 3			No
07	Metal to Metal		N/A	Group D, E								
08	Soft	2500	PEEK	Group B	Yes	BW	SPE x SPE	No	1, 2, 3	No		
09	Metal to Metal		N/A	Group D, E								
0A	Metal to Metal	800	N/A	Group F	Yes	SW	N/A	No	1, 2, 3			

Config. #	Sealing Type	Pressure Class	Seat Insert Material	Stem Seal Material	Fire Tested	End Connection	Seats Configuration	DBB	VSL	Fugitive Emission
F0	Soft	150, 300	PTFE + 25%C	Group B	Yes	Flanged	N/A	No	1, 2	Yes
		600, 900	PEEK				SPE x SPE			
		1500, 2500								
F1	Soft	800	PTFE + 25%C	Group B		SW, SE	N/A	No	1, 2, 3	
F2			PTFE + 25%C	Group C, E						
F3			PEEK	Group B						
F4			PEEK	Group C, E						
F5			Metal to Metal	N/A						
F6	Soft	1500	PEEK	Group B		SW	SPE x SPE	No	1, 2, 3	
F7	Metal to Metal		N/A	Group D, E						
F8	Soft	2500	PEEK	Group B		BW	SPE x SPE	No	1, 2, 3	
F9	Metal to Metal		N/A	Group D, E						
FA	Metal to Metal	800	N/A	Group F	SW	N/A	No	1,2		
FB	Soft	1500	PEEK	Group E	SW	SPE x SPE	No	1, 2		

A.7.1.6.4. BALL VALVES NPS 2 AND ABOVE AND DOUBLE BALL VALVES NPS 3 AND ABOVE

A.7.1.6.4.1. The following basic configurations shall be considered in the design of small ball and double ball valves:

Table A.26 – Typical configurations for metallic ball valves NPS 2 and above and double ball valve NPS 3 and above

Config. #	Sealing type	Seat Insert	Fire Tested	Pressure Class	Seats Configuration	DBB	VSL	Fugitive emission	
0	Soft	PTFE+25%C	No	150, 300	SPE x SPE	No	1, 2	No	
1			Yes				2		
2		PEEK	No	600, 900	SPE x SPE	No	1, 2		
3			Yes				2		
4		PEEK	No	600, 900 1500, 2500	SPE x SPE	Yes	1, 2		
5			Yes				2		
6		PTFE+25%C	No	150, 300	DIB-2	Yes	2, 3 <sup>2</sup>		
7			Yes						
8		PEEK	No	600, 900 1500, 2500	DIB-2	Yes	2, 3 <sup>2</sup>		
9			Yes						
0		Metal to Metal	N/A	No	150, 300, 600 900, 1500, 2500	SPE x SPE	No		1, 2
1				Yes					2
2	No			150, 300, 600 900, 1500, 2500	DIB-2	Yes	2, 3		
3	Yes								
4	Yes			150, 300, 600 900, 1500, 2500	DIB-2	Yes <sup>1</sup>	4		
5 <sup>3</sup>	Yes			1500, 2500	DIB-2	Yes <sup>1</sup>	4		
F	Soft	PTFE+25%C	Yes	150, 300	SPE x SPE	No	2		
		PEEK		600, 900 1500, 2500	SPE x SPE	Yes	2		
G		PTFE+25%C		150, 300	DIB-2	Yes	2, 3 <sup>2</sup>		
		PEEK		600, 900 1500, 2500	DIB-2	Yes	2, 3 <sup>2</sup>		
F	Metal to Metal	N/A		150, 300, 600 900, 1500, 2500	SPE x SPE	No	2		
G				150, 300, 600 900, 1500, 2500	DIB-2	Yes	2, 3		
U				150, 300, 600 900, 1500, 2500	DIB-2	Yes <sup>1</sup>	4		
E <sup>3</sup>				1500, 2500	DIB-2	Yes <sup>1</sup>	4		

<sup>1</sup> DBB designed for fully opened and closed position. The valve shall be able to perform DBB test on both conditions.  
<sup>2</sup> Soft seated ball valves with VSL-3 shall not be considered for use in hydrocarbon service lines.  
<sup>3</sup> Valve configurations used for HIPPS application.

A.7.1.6.5. RISING STEM BALL VALVES

A.7.1.6.5.1. The following basic configuration shall be considered in the design of rising stem ball valves:

Table A.27 – Typical configurations for rising stem ball valves

Config. #	Sealing type	Seat Insert	Fire Tested	Pressure Class	VSL
9	Metal to Metal	N/A	Yes	600,900	2,3

A.7.1.6.6. DOUBLE BALL VALVES

Table A.28 – Typical configurations for metallic double ball valves up to NPS 2

Config. #	Sealing type	Seat Seat Insert	Pressure Class	Stem Seal Material	Fire Tested	End Connection	VSL	Fugitive emission
01	Soft	PTFE+25%C	150, 300	Group B	Yes	Flanged	2	No
		PEEK	600, 900, 1500, 2500					
02		PTFE+25%C	150, 300					
		PEEK	600, 900, 1500, 2500					
03		PTFE+25%C	150, 300	Group E		Flanged		
		PEEK	600, 900, 1500, 2500					
04		PTFE+25%C	150, 300			Flanged x NPT		
		PEEK	600, 900, 1500, 2500					
05	Metal to Metal	N/A	150, 300, 600 900, 1500, 2500	Group E	Flanged			
06					Flanged x NPT			
07				Group F	Flanged			
08					Flanged x NPT			
F1	Soft	PTFE+25%C	150, 300	Group B	Yes	Flanged	2	Yes
		PEEK	600, 900, 1500, 2500					
F2		PTFE+25%C	150, 300					
		PEEK	600, 900, 1500, 2500					
F3		PTFE+25%C	150, 300	Group E		Flanged		
		PEEK	600, 900, 1500, 2500					
F4		PTFE+25%C	150, 300			Flanged x NPT		
		PEEK	600, 900, 1500, 2500					
F5	Metal to Metal	N/A	150, 300, 600 900, 1500, 2500	Group E	Flanged			
F6					Flanged x NPT			
F7				Group F	Flanged			
F8					Flanged x NPT			

**A.7.1.7. MATERIALS CONFIGURATIONS**

**A.7.1.7.1. STEM MATERIALS**

A.7.1.7.1.1. Table A.29 presents the standardized materials for each combination of material and pressure class of



the valve. The stem materials listed herein are considered to create a specific VDS.

A.7.1.7.1.2. Alternative materials are presented when applicable. The use of it shall be approved by PETROBRAS.

Table A.29 – Stem materials according to material class & pressure class of the valve

Material Class	Pressure Class							Alternative Materials
	150	300	600	800	900	1500	2500	
Carbon Steel	ASTM A276 or A479 (UNS S41000)							ASTM A564 Type 630 (UNS S17400) ASTM A276 or A479 (UNS S31803) ASTM A276 (UNS S32760) ASTM B637 (UNS N07718)
Low Temperature Carbon Steel	ASTM A276 or A479 (UNS S31600)					ASTM A564 Type 630 H1150 (UNS S17400)		ASTM A564 Type 630 H1150 (UNS S17400) ASTM A276 or A479 (UNS S31803) ASTM A276 (UNS S32760) ASTM B637 (UNS N07718)
Carbon Steel with Organic Coating (Onshore / Offshore)	ASTM A276 or A479 (UNS S31803)							ASTM A276 or A479 (UNS S31803) ASTM A276 or A479 (UNS S32760) ASTM B637 (UNS N07718)
Carbon Steel with Alloy 625 overlay (UNS N06625)	ASTM B637 (UNS N07718)							N/A
Stainless Steel	ASTM A276 or A479 (UNS S31600)					ASTM A276 or A479 (UNS S31803) <sup>1</sup>		ASTM B637 (UNS N07718) <sup>1</sup> ASTM A182 FXM-19
Duplex Steel	ASTM A276 or A479 (UNS S31803)							ASTM A276 (UNS S32760) ASTM B637 (UNS N07718) Hastelloy C276 (UNS N10276)
Super Duplex Steel	ASTM A276 or A479 (UNS S32760)							ASTM B637 (UNS N07718) Hastelloy C276 (UNS N10276)
Alloy Steel (ASTM A333 Gr.3)	ASTM B637 (UNS N07718)							N/A
Alloy Steel (ASTM A333 Gr.8)	ASTM B637 (UNS N07718)							N/A

Material Class	Pressure Class							Alternative Materials
	150	300	600	800	900	1500	2500	
<sup>1</sup> Whenever Group E is considered as seats / stem seals material in metal-to-metal ball valves (due to low temperature requirements), it shall be used ASTM B637 (UNS N07718).								

#### A.7.1.7.2. SPRING MATERIAL

A.7.1.7.2.1. All valves in carbon steel body material shall consider the use of Alloy X750 (UNS N07750) as spring material, to be used on the seat assembly. Other body material as below:

Table A.30 – Spring Material

Body Material	PREN	Requirements	Spring Material	Alternative Material			
Super Duplex	PREN > 40	Resistant to chloride and sour service - H <sub>2</sub> S	UNS N06625	UNS N10276	UNS R30003		
Duplex	35 > PREN > 40	Resistant to chloride and sour service - H <sub>2</sub> S	UNS N06625	UNS N10276	UNS R30003		
SS (316, ...)	24 > PREN > 35	Resistant to chloride and sour service - H <sub>2</sub> S	UNS N07718	UNS S06625	UNS N10276	UNS R30003	
Carbon and Low Alloy	PREN < 24	Resistant to chloride and sour service - H <sub>2</sub> S	UNS N07750 (Inconel X-750)	UNS N07718	UNS S06625	UNS N10276	UNS R30003
Bronze		Resistant to chloride service.	UNS N05500 (Monel K500)				

Note: The table above may be use for spring of check valves.

#### A.7.1.7.3. METALLIC COATING

A.7.1.7.3.1. Whenever specified in the VDS use of partial clad, it shall be considered the application according:

Table A.31 – Specification of metallic coating (partial clad) for ball valves

Partial Clad	
Stainless Steel (AISI 316) Weld Overlay	Valves with VSL = 2 which Material Class is Carbon Steel or Low Temperature Carbon Steel
Nickel Alloy (Alloy 625) Weld Overlay	Valves with VSL ≥ 3 and all valves with seals (seats/stem) using Group E. Note: Only applicable for valves with Material Classes Carbon Steel, Low Temperature Carbon Steel or Stainless Steel

A.7.1.7.3.2. Whenever specified in the VDS partial clad, it shall be considered the application of CRA (according Table A.31) on all body sealing areas.

- A.7.1.7.3.3. Whenever specified in the VDS full clad, it shall be according to item A.8.2.1.
- A.7.1.7.3.4. All metallic coatings shall attend the specific requirements listed in item A.8.2.1.

A.7.1.7.4. HARD COATING

- A.7.1.7.4.1. All designs of soft ball valves shall consider the application of hard coating on seats / ball according:

Table A.32 – Specification of hard coating on seats / ball on soft ball valves

VSL	Pressure Class						
	150	300	600	900	1500	2500	10000
VSL-1	N/A						
VSL-2	N/A				Tungsten Carbide or Chrome Carbide		
VSL-3	N/A		Tungsten Carbide or Chrome Carbide				
VSL-4	N/A						

- A.7.1.7.4.2. All designs of metal-to-metal ball valves shall consider the use of hard coating on seats / ball according:

Table A.33 – Specification of hard coating on seats / ball on metal-to-metal ball valves

VSL	Pressure Class						
	150	300	600	900	1500	2500	10000
VSL-1	Chromium Electroplate <sup>1</sup>		Tungsten Carbide <sup>2</sup> or Chrome Carbide				
VSL-2							
VSL-3	Tungsten Carbide <sup>2</sup> , Chrome Carbide or Chrome-Nickel Spray and Fuse						
VSL-4							
<sup>1</sup> If requested by the manufacturer, it may be acceptable the use of tungsten carbide or chrome carbide coating. <sup>2</sup> For valves which maximum design temperature 210°C.							

- A.7.1.7.4.3. All hard coatings application shall attend the specific requirements listed in item A.8.2.2.

A.7.1.7.5. SOFT SEATED BALL VALVES

Table A.34 – Typical configurations for soft seated ball valves according to material class

Material Class	Pressure Class	Seat Insert Material	Body Material <sup>2</sup>	Ball / Seats Material <sup>3</sup>
Carbon Steel	150 300	PTFE + 25%C	ASTM A105 or ASTM A216 WCB + Partial Clad <sup>1</sup>	AISI 410
	600 800 900	PEEK		AISI 410 + Hard Coating <sup>3</sup>

	1500 2500	PEEK		AISI 410 + Hard Coating <sup>3</sup>
Low Temperature Carbon Steel	150 300	PTFE + 25%C	ASTM A350 LF2 Cl1 or ASTM A352 Gr.LCC + Partial Clad <sup>1</sup>	AISI 316
	600 800 900	PEEK		AISI 316 + Hard Coating <sup>3</sup>
	1500 2500	PEEK		AISI 316 + Hard Coating <sup>3</sup>
Carbon Steel with Organic Coating (Onshore)	150 300	PTFE + 25%C	ASTM A105 or ASTM A216 WCB	ASTM A995 Gr.1b
Carbon Steel with Organic Coating (Offshore)	150 300	PTFE + 25%C	ASTM A105 or ASTM A216 WCB	UNS S31803
	1500	PEEK		UNS S31803 + Hard Coating <sup>3</sup>
Stainless Steel	150 300	PTFE + 25%C	ASTM A182 Gr. F316 or ASTM A351 Gr. CF8M + Partial Clad <sup>1</sup>	AISI 316
	600 800 900	PEEK		AISI 316 + Hard Coating <sup>3</sup>
	1500 2500	PEEK		AISI 316 + Hard Coating <sup>3</sup>
Duplex Steel	150 300	PTFE + 25%C	ASTM A182 Gr. F51 or ASTM A995 Gr. 4a or ASTM A995 Gr. 1b (onshore only)	UNS S31803
	600 800 900	PEEK		UNS S31803 + Hard Coating <sup>3</sup>
	1500 2500	PEEK		UNS S31803 + Hard Coating <sup>3</sup>
Super Duplex Steel	150 300	PTFE + 25%C	ASTM A182 Gr. F55 or ASTM A995 Gr 6a	UNS S32760
	600 800 900	PEEK		UNS S32760 + Hard Coating <sup>3</sup>
	1500 2500	PEEK		UNS S32760 + Hard Coating <sup>3</sup>

Alloy Steel (ASTM A333 Gr.3)	600 800 900	PEEK	ASTM A350 Gr. LF3 or ASTM A352 Gr. LF3	UNS N06625 + Hard Coating <sup>3</sup>
Alloy Steel (ASTM A333 Gr.8)	2500	PEEK	ASTM A522 Type I	ASTM A522 Type I + Hard Coating <sup>3</sup>

<sup>1</sup> Partial clad may be requested in the VDS and shall be according Table A.31.

<sup>2</sup> The use of forging or casting shall be according VSL classification. For valves with NPS < 2, It shall be considered only the use of forging material.

<sup>3</sup> Hard Coatings may be requested in the VDS and shall be applied according Table A.32.

#### A.7.1.7.6. METAL SEATED BALL VALVES

Table A.35 – Typical configurations for metal-to-metal seated ball valves according to material class

Material Class	Pressure Class	Body Material <sup>1,2</sup>	Ball / Seats Material <sup>3</sup>
Carbon Steel	150 300 600 800 900 1500 2500 10000psi	ASTM A105 or ASTM A216 WCB + Partial Clad <sup>1</sup>	AISI 410 + Hard Coating <sup>3</sup>
Low Temperature Carbon Steel		ASTM A350 LF2 Cl1 or ASTM A352 Gr.LCC + Partial Clad <sup>1</sup>	AISI 316 + Hard Coating <sup>3</sup>
Stainless Steel		ASTM A182 Gr. F316L or ASTM A351 Gr. CF8M + Partial Clad <sup>1</sup>	AISI 316 + Hard Coating <sup>3</sup>
Duplex Steel		ASTM A182 Gr. F51 or ASTM A995 Gr 4A	UNS S31803 + Hard Coating <sup>3</sup>
Super Duplex Steel		ASTM A182 Gr. F55 or ASTM A995 Gr 6A	UNS S32760 + Hard Coating <sup>3</sup>
Alloy Steel (ASTM A333 Gr.3)		600 800 900	ASTM A350 Gr. LF3 or ASTM A352 Gr. LF3

Material Class	Pressure Class	Body Material <sup>1, 2</sup>	Ball / Seats Material <sup>3</sup>
Alloy Steel (ASTM A333 Gr.8)	2500 10000psi	ASTM A522 Type I	ASTM A522 Type I + Hard Coating <sup>3</sup>
<sup>1</sup> Partial clad may be requested in the VDS and shall be according Table A.31. <sup>2</sup> The use of forging or casting shall be according VSL classification. For valves with NPS < 2, It shall be considered only the use of forging material. <sup>3</sup> Hard Coatings may be requested in the VDS and shall be applied according Table A.32.			

### A.7.1.8. BALL VALVES ACCORDING TO IOGP S-562

A.7.1.8.1. Ball valves included in scope of S-562 shall comply with S-562, this Annex and following requirements/modifications.

A.7.1.8.2. Design validation shall be as required by Table A.3.

A.7.1.8.3. Process fabrication for body materials shall be according Table A.7.

A.7.1.8.4. Table J.3 of S-562, sequence 7, shall be read as: Low-pressure pneumatic seat test at 5 psi to 14.5 psi (0.34 bar to 1 bar) per H.3.2 Type I.

A.7.1.8.5. For fluid services such as aromatic hydrocarbons, steam, methanol, amines, strong alkalis and some Freons, Table A.21 and Table A.22 shall be used as reference to selection of suitable sealing material.

A.7.1.8.6. For classes 150 to 600, all sizes, and for classes 900 to 2500, sizes NPS 8 (DN 200), vents and drains shall have double seal (axial outboard and radial inboard) parallel threads with locking ring. During loosening of the fitting, the design configuration shall ensure pressure is relieved from the inboard seal without thread disengagement.

A.7.1.8.7. NDE, tests and documentation of each valve shall be according A.7.1.8.7.1 to A.7.1.8.7.4.

A.7.1.8.7.1. VSL-1 valves shall comply with S-562 QSL-1 requirements.

A.7.1.8.7.2. VSL-2 valves shall comply with S-562 QSL-2 or QSL-2G requirements as applicable.

A.7.1.8.7.3. VSL-3 valves shall comply with S-562 QSL-3 or QSL-3G requirements as applicable.

A.7.1.8.7.4. VSL-4 valves shall comply with S-562 QSL-4 requirements.

A.7.1.8.8. SDV, BDV, XV and ADV valves shall be fire tested. For other valves, fire type-tested certified design shall be required according to design premises.

### A.7.2. GATE VALVE

#### A.7.2.1. DESIGN REQUIREMENTS

A.7.2.1.1. It shall be considered a Metal-to-Metal seated design for all types of gate valve. Expanding gate valves may have an additional non-metallic insert.

A.7.2.1.2. Whenever specified in the VDS, the manufacturer shall attend to the requirement of coating, such as metallic coating, hard coating and/or organic coating specified for some parts and sealing surfaces, such as in the body, bonnet, gate, seats, etc. In this case, the manufacturer shall attend the applicable requirements listed on item A.8.2.

A.7.2.1.3. Gate valves, with flanged or butt weld ends, shall have face to face dimensions according to ASME B16.10.

A.7.2.1.4. End connections shall be according:

- a) Flanged ends: according to ASME B16.5 up to DN 600 (NPS 24) for ASME classes 150 to 1500, and up to DN 300 (NPS 12) for class 2500; according to ISO 27509 for DN 400 (NPS 14) to NPS 600 (NPS 24) in ASME class 2500; according to ASME B16.47 Series A from DN 650 (NPS 26) up to DN 1500 (NPS 60) for ASME Classes 150 to 600, and from DN 650 (NPS 26) up to DN 1200 (NPS 48) for ASME class 900.
- b) Screwed ends: according to ASME B1.20.1 NPT;
- c) Butt weld: according to ASME B16.25;
- d) Socket weld: according to ASME B16.11.

A.7.2.1.5. The design of gate and body guides shall be optimized with respect to chamfers, clearances and machining to ensure valves operate smoothly during operation without self-locking, seizure, internal wear or galling effects in the absence of any form of lubrication.

A.7.2.1.6. In case the design of a gate valve consider the use of drain and vent ports, the plugs shall be specified considering the alert given in item A.6.1.1.10.

A.7.2.1.7. Up to and including DN 40 (NPS 1 ½), the valve shall be furnished with a solid wedge.

### A.7.2.2. DESIGN STANDARD

A.7.2.2.1. The following standards shall be considered for the design of gate valves:

Table A.36 – Design Standards for gate valves

Description	Body / Closure Material					
	Forging			Forging or Casting		
	Socket weld	Butt weld	Flange	Flange		
DN (NPS)	15 up to 40 (1/2 up to 1 1/2)	25 up to 40 (1 up to 1 1/2)	46 up to 346 (1 13/16 up to 13 5/8)	50 up to 600 (2 up to 42)	50 up to 400 (2 up to 24)	50 up to 300 (2 up to 12)
Class	800 and 1500	2500	10.000 psi	150 and 300	600 to 1500	2 500
Standard	API 602	ASME B16.34 LTD	API 6A	API 600 or API 603 / IOGP S-611 <sup>a</sup>		

<sup>a</sup> As applicable. See also A.7.2.5

### A.7.2.3. NON-METALLIC SEALS

A.7.2.3.1. All non-metallic seals shall be suitable for the pressure, temperature and service conditions specified in the VDS.

A.7.2.3.2. The manufacturer of the valve shall guarantee together with your seals supplier(s) the necessary material requirements for the non-metallic seals, in order to ensure that the designed seal system works properly during the whole design life of the valve.

A.7.2.3.3. For solid wedge gate valves, the design shall consider the use of gaskets made of flexible graphite with inconel wire for the stem seal.

A.7.2.3.4. The design of a slab gate valve shall consider the use of non-metallic seals, mounted on seats and stem,

according to the materials specified in the VDS.

#### A.7.2.4. TYPICAL CONFIGURATIONS

A.7.2.4.1. This item presents typical configurations for gate valves, as a result of combinations of materials and features. The following configurations are considered to create a specific VDS.

A.7.2.4.2. The referred number of the typical configuration of a gate valve, shown on the first column of Table A.37, Table A.38 and Table A.39, shall be considered as a part of the valve code, according item A.11.5.

#### A.7.2.4.3. TRIM MATERIAL CONFIGURATION FOR SOLID WEDGE GATE VALVES

Table A.37 – TRIM material configuration for solid wedge gate valves

Material Class	Body Material	API 600 TRIM Number	Gate Material	Seat Material	Stem Material
Carbon Steel	ASTM A105 or ASTM A216 Gr. WCB	Trim Number 8 (API 600 / 602)	AISI 410	Stellite (Co-Cr Alloy)	ASTM A276 (UNS S41000)
	ASTM A105 or ASTM A216 Gr. WCB	Trim Number 5 (API 600 / 602)	Stellite (Co-Cr Alloy)	Stellite (Co-Cr Alloy)	ASTM A276 (UNS S41000)
	ASTM A350 LF2 Cl 1 or ASTM A352 Gr. LCC	Trim Number 16 (API 600 / 602)	AISI 316	Stellite (Co-Cr Alloy)	ASTM A276 (UNS S31803)
	ASTM A105 or ASTM A216 Gr. WCB + Organic Coating	-	ASTM A995 Gr. 1b  ASTM A995 Gr. 4a	ASTM A995 Gr. 1b  ASTM A995 Gr. 4a	ASTM A276 (UNS S32550)  ASTM A276 (UNS S31803)
Stainless Steel	ASTM A182 Gr. F316 or ASTM A351 Gr. CF8M	Trim Number 16 (API 600 / 602)	AISI 316	Stellite (Co-Cr Alloy)	A276 316 / 316L
Duplex Steel	ASTM A182 F51 or ASTM A995 Gr. 4a	-	UNS S31803	UNS S31803	ASTM A276 (UNS S31803)
	ASTM A182 F55 or ASTM A995 Gr. 6a	-	UNS S32760	UNS S32760	ASTM A276 (UNS S32760)
Nickel Alloy	ASTM B564 (UNS N06625)	-	ASTM B564 (UNS N06625)	ASTM B564 (UNS N06625)	ASTM B637 (UNS N07718)
Uncommon Materials	Bronze ASTM B61 (UNS C92200)	-	ASTM B61 (UNS C92200)	ASTM B61 (UNS C92200)	ASTM B61 (UNS C92200)
	Gray Iron ASTM A126 Cl. B	-	ASTM B62 (UNS C83600)	ASTM B62 (UNS C83600)	ASTM B62 (UNS C83600)
	Nickel Aluminum Bronze	-	ASTM B148 (UNS C95800)	ASTM B148 (UNS C95800)	ASTM B150 (UNS C63200)



Material Class	Body Material	API 600 TRIM Number	Gate Material	Seat Material	Stem Material
	ASTM B148 (UNS C95800)				

A.7.2.4.4. OBTURATOR TYPE

Table A.38 – Obturator type for gate valves

Obturator type	
0	Solid wedge
1	Slab gate
2	Expanding gate
3	Flexible wedge

A.7.2.4.5. TRIM DESIGN

Table A.39 – Trim selection

TRIM design	
1	Standard Trim
2	Alternative Trim
3	Special Trim
F	Standard Trim, with fugitive emission

**A.7.2.5. GATE VALVES ACCORDING TO IOGP S-611**

**A.7.2.6. GATE VALVES INCLUDED IN SCOPE OF S-611 SHALL COMPLY WITH S-611 AND FOLLOWING REQUIREMENTS/MODIFICATIONS.**

**A.7.2.7. DESIGN VALIDATION SHALL BE AS REQUIRED BY TABLE A.3.**

**A.7.2.8. PROCESS FABRICATION FOR BODY MATERIALS SHALL BE ACCORDING TO TABLE A.7.**

**A.7.2.9. FIRST PARAGRAPH OF S-611 ITEMH.3.5 SHALL BE READ AS: VALVES SHALL BE TESTED WITH FULL PRESSURE END THRUST EFFECT TO CHECK THE EFFECTIVENESS OF BODY JOINTS AND TIGHTNESS AS PER TABLE H.5. TEST SHALL BE CARRIED OUT WITH HORIZONTAL FLOW BORE AND STEM HORIZONTAL TO DEMONSTRATE COMPLIANCE WITH 5.6.3/5.6.5 (API 600/APII 603).**

**FOR THIS SELECTED VALVE FROM TABLE H.5, FUNCTIONAL TEST IN ACCORDANCE WITH H.3.6.2, EXCEPT STEP (A) (2), SHALL BE CARRIED OUT OVER FIVE CYCLES.**

**A.7.2.10. NDE, TESTS AND DOCUMENTATION OF EACH VALVE SHALL BE ACCORDING A.7.2.11 TO A.7.2.14.**

**A.7.2.11. VSL-1 VALVES SHALL COMPLY WITH S-611 QSL-1 REQUIREMENTS;**

**A.7.2.12. VSL-2 VALVES SHALL COMPLY WITH S-611 QSL-2 OR QSL-2G REQUIREMENTS AS APPLICABLE;**

**A.7.2.13. VSL-3 VALVES SHALL COMPLY WITH S-611 QSL-3 OR QSL-3G REQUIREMENTS AS APPLICABLE;**

**A.7.2.14. VSL-4 VALVES SHALL COMPLY WITH S-611 QSL-4 REQUIREMENTS.**

**A.7.3. CHECK VALVE**

**A.7.3.1. DESIGN REQUIREMENTS**

A.7.3.1.1. Check valves, with flanged or butt weld ends, shall have face to face dimensions according to ASME B16.10.

A.7.3.1.2. End connections shall be according:

- a) Flanged ends: according to ASME B16.5 up to DN 600 (NPS 24) for ASME classes 150 to 1500, and up to DN 300 (NPS 12) for class 2500; according to ASME B16.47 Series A from DN 650 (NPS 26) up to 1500 (NPS 60) for ASME Classes 150 to 600, and from DN 650 (NPS 26) up to DN 1200 (NPS 48) for ASME Class 900; according to ISO 27509 for DN 350 (NPS 14) up to DN 500 (NPS 24) for ASME Class 2500.
- b) Screwed ends: according to ASME B1.20.1 NPT;
- c) Butt weld: according to ASME B16.25;
- d) Socket weld: according to ASME B16.11.

A.7.3.1.3. For other materials not specified in the VDS, such as bolts, nuts, washers and lock pins, it shall be considered the use of materials with similar corrosion resistance than the materials indicated for the internals.

A.7.3.1.4. Whenever specified in the VDS, the manufacturer shall attend to the coating, such as metallic coating, hard coating and/or organic coating specified for some parts and sealing surfaces. In this case, the manufacturer shall attend the applicable requirements listed on item A.8.2.

A.7.3.1.5. In case the design of a check valve considers the use of drain and vent ports, the plugs shall be specified considering the alert given in item A.6.1.1.10.

**A.7.3.2. DESIGN STANDARD**

A.7.3.2.1. The following standards shall apply to the design of check valves:

Table A.40 – Design Standards for check valves

Description	Body / Closure Material							
	Casting	Forging	Forging	Forging or Casting				Forging
	Flanged or Screwed End	Flanged or Socket weld	Butt welding	Flanged, wafer and lug				Flanged
DN (NPS)	15 up to 40 (1/2 up to 1 1/2)	15 up to 40 (1/2 up to 1 1/2)	25 up to 40 (1 up to 1 1/2)	50 up to 1200 (2 up to 48)	50 up to 1050 (2 up to 42)	50 up to 600 (2 up to 24)	50 up to 300 (2 up to 12)	50 up to 254 (2 up to 10)
Class	150, 200	800 and 1500	2500	150 and 300	600	900 and 1500	2500	10.000 psi

Description	Body / Closure Material				
	Casting	Forging	Forging	Forging or Casting	Forging
	Flanged or Screwed End	Flanged or Socket weld	Butt welding	Flanged, wafer and lug	Flanged
Standard	MSS SP-80	API 602	ASME B16.34 LTD	API 594, API 6D	API 6A

### A.7.3.3. NON-METALLIC SEALS

A.7.3.3.1. For the design of soft seated dual plate check valve, the VDS contains indication about the non-metallic group material that shall be considered in the valve design, in this case:

- Group A – Terpolymer of VF2, HFP e TFE with fluor content of ~ 67 - 70% or HNBR with %ACN between 36 and 40%. E.g.: Viton B (DuPont), Technoflon TN (Solvay Solexis);

Table A.41 – Seal group materials for soft seated dual plate check valve

Seals Group	Application	Operating Temp. <sup>1</sup>		Design Temp. <sup>2</sup>		Seals Materials	Seals Design	RGD	Suitable for	Group Restrictions
		Min. (°C)	Max. (°C)	Min. (°C)	Max. (°C)					
Group A	Normal Temperature	0	+150	0	+170	HNBR FKM Type 2	O-ring Polypak Gasket	No	Water, Utility, Sweet hydrocarbon and Chemicals	Amines, Steam, Aromatic hydrocarbons <sup>3</sup>

<sup>1</sup> Temperature range considered for continuous service without reducing the seals' economic life or its sealing capability.  
<sup>2</sup> Temperature range considered whether the seals may be exposed for a short period of time (transient temperature spike), under a static condition (without operation), with a possible leakage but without permanently damaging the sealing system.  
<sup>3</sup> Hydrocarbons streams containing more than 25% aromatics.

### A.7.3.4. TYPICAL CONFIGURATIONS

A.7.3.4.1. This item presents typical configurations for check valves, as a result of combinations of materials and features. The following configurations are considered to create a specific VDS.

A.7.3.4.2. The referred number of the typical configuration of a check valve, shown on the first column of Table A.42, Table A.43 and Table A.44, shall be considered as a part of the valve code, according item A.11.5.

#### A.7.3.4.3. TRIM MATERIAL ACCORDING TO MATERIAL CLASS

Table A.42 – TRIM material according to material class

Material Class	Body Material	Soft Sealing	Metal-to-metal Sealing	
		Primary TRIM	Primary TRIM <sup>1</sup>	Secondary TRIM <sup>2</sup>
Carbon Steel	ASTM A105 or ASTM A216 WCB	Trim Number 1 (API 594)	Trim Number 8 (API 594)	Trim Number 5 (API 594)
Low Temperature Carbon Steel	ASTM A350 LF2 Cl.1 or ASTM A352 LCC	Trim Number 10 (API 594)	Trim Number 12 (API 594)	N/A
Stainless Steel	ASTM A182 F316	Trim Number 10	Trim Number 12	N/A

Material Class	Body Material	Soft Sealing	Metal-to-metal Sealing	
		Primary TRIM	Primary TRIM <sup>1</sup>	Secondary TRIM <sup>2</sup>
	or ASTM A351 CF8M	(API 594)	(API 594)	
Duplex Steel (Onshore)	ASTM A995 Gr. 1b	ASTM A995 Gr. 1b	N/A	N/A
Duplex Steel (Offshore)	ASTM A182 F51 or ASTM A995 Gr. 4a	ASTM A182 F51 or ASTM A995 Gr. 4a	ASTM A182 F51 or ASTM A995 Gr. 4a	N/A
Superduplex Steel	ASTM A182 F55 or ASTM A995 Gr. 6a	ASTM A182 F55 or ASTM A995 Gr. 6a	ASTM A182 F55 or ASTM A995 Gr. 6a	N/A
Alloy Steel (ASTM A333 Gr.3)	ASTM A350 LF3 or ASTM A352 LF3 + Alloy 625 (UNS N06625)	N/A	ASTM A350 LF3 + Alloy 625 (UNS N06625)	N/A
Alloy Steel (ASTM A333 Gr.8)	ASTM A522 Type I	N/A	ASTM A522 Type I	N/A
Alloy Steel (ASTM A333 Gr.8) with nickel-based alloy cladding	ASTM A522 Type I + Alloy 625 (UNS N06625)	N/A	ASTM A522 Type I + Alloy 625 (UNS N06625)	N/A
Nickel Aluminum Bronze	ASTM B148 (UNS C95800)	ASTM B148 (UNS C95800)	N/A	N/A
Gray Iron	ASTM A126 CI B	TRIM AA (API 594)	N/A	N/A

#### A.7.3.4.4. OBTURATOR TYPE

Table A.43 – Obturator type for check valves

Config. #	Type
0	Piston
1	Dual plate
2	Swing
3	Axial non-slam
4	Ball
5	Swing, spring loaded, non-slam
6	Manufacturer standard

#### A.7.3.4.5. TRIM SELECTION

Table A.44 – TRIM selection

Config. #	Type	Body Construction
1	Primary TRIM (Soft)	Wafer

2	Primary TRIM (Metal x Metal)	Wafer
3	Secondary TRIM (Metal x Metal)	Wafer
4	Alternative TRIM	Wafer
5	Primary TRIM (Metal x Metal)	Double Flanged Short Pattern or Studded End (API 6A)
6	Lined	Flanged

#### A.7.4. GLOBE VALVE

##### A.7.4.1. DESIGN REQUIREMENTS

A.7.4.1.1. It shall be considered a metal-to-metal seated design for all types of globe valve.

A.7.4.1.2. Whenever specified in the VDS, the manufacturer shall attend to the requirement of coating, such as metallic coating, hard coating and/or organic coating specified for some parts and sealing surfaces, such as in the body, etc. In this case, the manufacturer shall attend the applicable requirements listed on item A.8.2.

A.7.4.1.3. Globe valves, with flanged or butt weld ends, shall have face to face dimensions according to ASME B16.10.

A.7.4.1.4. End connections shall be according:

- a) Flanged ends: According ASME B16.5 up to DN 600 (NPS 24) for ASME classes 150, 300, 600 and 900, according to ASME B16.47 Series A from DN 650 up to DN 1500 (NPS 26-60) for and from DN 650 up to DN 1200 (NPS 26-48) for ASME class 900.
- b) Screwed ends: according to ASME B1.20.1 NPT;
- c) Butt weld: according to ASME B16.25;
- d) Socket weld: according to ASME B16.11.

##### A.7.4.2. DESIGN STANDARD

A.7.4.2.1. The following standards shall apply to the design of globe valves:

Table A.45 – Design Standards for globe valves

Description	Forging		Casting or Forging	
	Socket Weld	Butt Weld	Flange	
<b>DN<sup>a</sup> (NPS)</b>	15 up to 40 (1/2 up to 1 1/2)	25 up to 40 (1 up to 1 1/2)	50 up to 600 (2 up to 24)	50 up to 300 (2 up to 12)
<b>Class</b>	800 and 1500	2500	150 up to 1500	2500
<b>Standard</b>	API 602	ASME B16.34 LTD	API 623 <sup>b</sup>	

<sup>a</sup> DN = Nominal diameter, in millimeters (mm).  
<sup>b</sup> BS 1873 can be accepted as well.

##### A.7.4.3. TYPICAL CONFIGURATIONS

A.7.4.3.1. This item presents typical configurations for globe valves, as a result of combinations of materials and features. The following configurations are considered to create a specific VDS.

A.7.4.3.2. The referred number of the typical configuration of a globe valve, shown on the first column of Table A.46 and Table A.47, shall be considered as a part of the valve code, according item A.11.5.

##### A.7.4.3.3. TRIM MATERIAL CLASS CONFIGURATION

Table A.46 – TRIM design code for globe valves

Material Class	Body Material	Metal-to-metal Sealing		Metal-to-metal Sealing, alternative face type
		Primary TRIM <sup>1</sup>	Secondary TRIM	Primary TRIM <sup>1</sup>
		1	2	3
Carbon Steel	ASTM A105 or ASTM A216 WCB	CR13 and HF (BS 1873)	HF (BS 1873)	
Carbon Steel with organic coating	ASTM A105 or ASTM A216 WCB	ASTM A995 Gr. 4a	ASTM A995 Gr 1b	
Low Temperature Carbon Steel	ASTM A350 LF2 Cl.1 or ASTM A352 LCC	AISI 316 + Stellite	N/A	
Stainless Steel	ASTM A182 F316L or ASTM A351 CF8M	AISI 316 + Stellite	N/A	
Duplex Steel	ASTM A182 F51 or ASTM A995 Gr. 4a	ASTM A182 F51 or ASTM A995 Gr. 4a	N/A	
Super duplex Steel	ASTM A182 F55 or ASTM A995 Gr. 6a	ASTM A182 F55 or ASTM A995 Gr. 6a	N/A	ASTM A182 F55 or ASTM A995 Gr. 6a
Alloy Steel (ASTM A333 Gr.3)	ASTM A350 LF3 or ASTM A352 LF3	ASTM A350 LF3	N/A	
Alloy Steel (ASTM A333 Gr.8)	ASTM A522 Type I	ASTM A522 Type I	N/A	
Nickel Aluminum Bronze	ASTM B148 (UNS C95800)	NAB (BS 1873)	N/A	

A.7.4.3.4. OBTURATOR TYPE

Table A.47 – Obturator type for globe valves

Config. #	Type
0	Bevelled disc
1	Angular

A.7.5. BUTTERFLY VALVE

A.7.5.1. DESIGN REQUIREMENTS

A.7.5.1.1. It shall be considered the following types of butterfly valves: Category A (concentric), Category B (Double offset) and Category B (Triple Offset).

A.7.5.1.2. All butterfly valves category B with triple offset shall consider a metal-to-metal seated design.

A.7.5.1.3. Whenever specified in the VDS, the manufacturer shall attend to the requirement of coating, such as metallic coating and/or hard coating specified for some parts and sealing surfaces, such as in the body or disc. In this case, the manufacturer shall attend the applicable requirements listed on items A.7.5.4.3 and A.8.2.

A.7.5.1.4. Butterfly valves and its actuators shall be designed and tested considering the maximum differential pressure equal to the maximum pressure rating of the associated flange class.

### A.7.5.2. DESIGN STANDARD

A.7.5.2.1. The following standards shall apply to the design of butterfly valves:

Table A.48 – Design Standards for butterfly valves

Description	Category A	Category B		
	Concentric	Double offset and Triple offset		
	Lug	Lug <sup>b</sup>	Flanged <sup>c</sup> (Short Pattern)	
	Ductile Iron	Forging or Casting		
<b>DN<sup>a</sup> (NPS)</b>	50 to 1200 (2 to 48)	50 to 1500 (2 to 60)	75 to 1500 (3 to 60)	75 to 1500 (3 to 60)
<b>Class</b>	Maximum Working Pressure (MWP)	150 and 300	600	150 up to 600
<b>Standard</b>	API 609			
<sup>a</sup> DN = Nominal diameter, in millimeters (mm); <sup>b</sup> Usually up to NPS 20; <sup>c</sup> Usually NPS 24 and above.				

### A.7.5.3. NON-METALLIC SEALS

A.7.5.3.1. For the design of seats / stem seals, in butterfly valves Category A or B, the following materials shall be considered:

Table A.49 – Non-metallic materials for seats / stem seal design

Type	Material	Minimum Temp. (°C)	Maximum Temp. (°C)
Category A	NBR	-10	+80
	FKM	-10	+150
Category B (Double Offset)	RPTFE	-46	+260
Category B (Triple Offset)	Graphite	-240	+550

Note: Temperature values listed in Table A.49 represents the limits of use the non-metallic material on a butterfly valve design.

**A.7.5.4. MATERIAL CONFIGURATION**

A.7.5.4.1. CATEGORY B (TRIPLE OFFSET) CONFIGURATION

A.7.5.4.2. For the design of butterfly valves category B (triple offset), it may be considered one of the following configurations:

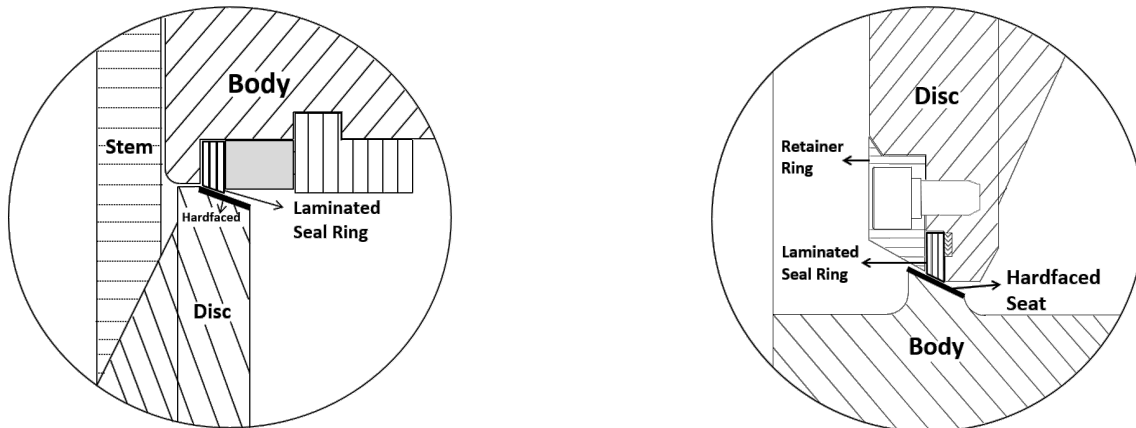

(a) Seal ring fixed to body & hard coating on disc

(b) Seal ring fixed to disc & hard coating on body

Figure A.9 – Illustration of typical category B (triple offset) seat configurations

A.7.5.4.3. METALLIC COATING

A.7.5.4.3.1. Whenever AISI 410 is considered as disc material for category B butterfly valves, it shall be applied ENP coating on disc sealing surface.

A.7.5.4.3.2. On triple offset butterfly valves (category B), it shall be applied metallic coating on sealing surface (disc or body, depending on configuration as described in Figure A.9). In this case, the use of Cobalt-Chromium (Co-Cr) weld overlay or ENP are acceptable.

A.7.5.4.3.3. All metallic coatings application shall attend the specific requirements listed in item A.8.2.1.

**A.7.5.5. TYPICAL CONFIGURATIONS**

A.7.5.5.1. MATERIAL CLASS CONFIGURATION

Table A.50 – Material class configuration for butterfly valves

Material Class	Body Material	Type	Disc Material	Seats <sup>1</sup>	Stem	Seal Ring
Carbon Steel	ASTM A105 or ASTM A216 Gr. WCB	Category B (Double Offset)	AISI 410 + ENP	RPTFE	ASTM A276 (UNS S41000)	N/A
		Category B (Triple Offset)	AISI 316	AISI 316 + Hard Coating	ASTM A564 Type 630 (UNS S17400)	Graphite Laminated with AISI 316
Ductile Iron	ASTM A536 Gr 65-45-12	Category A (Concentric)	ASTM B148 (UNS C95800)	NBR	ASTM B865 (UNS N05500)	N/A
			ASTM A536 Gr 65-45-12 +	NBR	ASTM A276 (UNS S41000)	N/A



Material Class	Body Material	Type	Disc Material	Seats <sup>1</sup>	Stem	Seal Ring
			PA Coating			
			ASTM A536 Gr 65-45-12 + PA Coating	NBR	ASTM A276 (UNS S31803)	N/A
Low Temperature Carbon Steel	ASTM A352 Gr. LCC	Category B (Triple Offset)	AISI 316	AISI 316 + Hard Coating	ASTM A564 Type 630 H1150 (UNS S17400)	Graphite Laminated with AISI 316
Stainless Steel	ASTM A351 CF8M	Category B (Double Offset)	AISI 316	RPTFE	ASTM A564 Type 630 H1150 (UNS S17400)	Graphite Laminated with AISI 316
Duplex Steel	ASTM A995 Gr. 4a	Category B (Double Offset)	Duplex (UNS S31803)	RPTFE	ASTM A276 (UNS S31803)	N/A
		Category B (Triple Offset)	Duplex (UNS S31803)	Duplex (UNS S31803) + Hard Coating	ASTM A276 (UNS S31803)	Graphite Laminated with Duplex (UNS S31803)
Super duplex Steel	ASTM A995 Gr. 6a	Category B (Double Offset)	Super duplex (UNS S32760)	RPTFE	ASTM A276 (UNS S32760)	N/A
		Category B (Triple Offset)	Super duplex (UNS S32760)	Super duplex (UNS S32760) + Hard Coating	ASTM A276 (UNS S32760)	Graphite Laminated with Super duplex (UNS S32760)
Nickel Aluminum Bronze	ASTM B148 (UNS C95800)	Category B (Double Offset)	ASTM B148 (UNS C95800)	RPTFE	ASTM B865 (UNS N05500)	N/A
		Category B (Triple Offset)	ASTM B148 (UNS C95800)	ASTM B148 (UNS C95800) + Hard Coating	ASTM B574 (UNS N10276)	Graphite Laminated with Hastelloy (UNS N10276)

<sup>1</sup> For all triple offset butterfly valves (category B), the VDS have taken into consideration typical configuration “(a) Seal ring fixed to body & hard coating on disc”, as described in Figure A.9. Adequate adjustments shall be made for use of configuration “(b) Seal ring fixed to disc & hard coating on body”.

#### A.7.5.5.2. DISC & SEAT CONFIGURATION

Table A.51 – Disc & Seat Configuration for butterfly valves

Config. #	Category (Ref. API 609)	Disc & Seat Configuration
0	Category A	Concentric, trim 1 (monel)
1	Category B	Double offset (bi-eccentric), soft-seated
2	Category B	Triple offset (tri-eccentric)
3	Category B	Double offset (bi-eccentric), metal-seated
4	Category A	Concentric, trim 2 (410)
5	Category B	Double offset (bi-eccentric), soft-seated, fire-tested
6	Category B	Triple offset (tri-eccentric), fire-tested

7	Category B	Double offset (bi-eccentric), metal-seated, fire-tested
8	Category A	Concentric, trim 3 (22 CR)
9	Category A	Concentric, trim 4 (NAB)
F	Category B	Double offset (bi-eccentric), soft-seated, fire-tested, fugitive emission
U	Category B	Triple offset (tri-eccentric), fire-tested, fugitive emission
G	Category B	Double offset (bi-eccentric), metal-seated, fire-tested, fugitive emission

A.7.5.5.3. END CONNECTION

Table A.52 – End connection configuration for butterfly valves

				Face type	Lug	Double Flanged (Short Pattern)
				RF	1	3
				FF	4	6
				RTJ	7	9

A.7.6. NON-METALLIC VALVE

A.7.6.1. TYPICAL CONFIGURATION

A.7.6.1.1. MATERIAL CONFIGURATION

Table A.53 – Material configuration for non-metallic valves

Config. #	Material
01	PVC
02	CPVC
03	FRP

A.7.6.2. DESIGN REQUIREMENTS FOR NON-METALLIC VALVE

A.7.6.2.1. The design of non-metallic ball valve shall consider the minimum pressure – temperature rating as follows:

Table A.54 – Minimum pressure (psig) – temperature rating for non-metallic ball valves

Material	PVC		CPVC		FRP		
	DN (NPS)		DN (NPS)		DN (NPS)		
	1/2 up to 1 1/2	≥ 2	1/2 up to 1 1/2	≥ 2	1/2 up to 1 1/2	2 up to 3	4 up to 10
23°C	250	150	250	150	275	250	150
30°C	235	150	250	150	275	250	150
35°C	212	150	245	150	275	250	150
40°C	192	144	232	146	250	225	140
45°C	N/A		211	137	250	225	140
50°C			188	128	250	225	140
55°C			179	119	250	225	140
60°C			170	101	250	225	140

65°C		161	92	250	225	140
70°C		140	83	232	210	130
80°C		134	74	232	210	130

A.7.6.2.2. The design of non-metallic check valve shall consider the minimum pressure – temperature rating as follows:

Table A.55 – Minimum pressure (psig) – temperature rating for non-metallic check valves

Material	PVC	CPVC
Temp.		
23°C	150	150
30°C	150	150
35°C	150	150
40°C	144	146
45°C	N/A	137
50°C		128
55°C		119
60°C		110
65°C		101
70°C		92
75°C		83
80°C		74

A.7.6.2.3. The design of non-metallic butterfly valve shall consider the minimum pressure – temperature rating as follows:

Table A.56 – Minimum pressure (psig) – temperature rating for non-metallic butterfly valves

Material	PVC	CPVC
Temp.		
23°C	150	150
30°C	132	140
35°C	115	129
40°C	97	119
45°C	N/A	108
50°C		98
55°C		87
60°C		77
65°C		66
70°C		56
75°C		45
80°C		35

## A.8. MATERIALS & FABRICATION

### A.8.1. REQUIREMENTS FOR CASTING OF DUPLEX & SUPERDUPLEX

#### A.8.1.1. SCOPE

A.8.1.1.1. All valves made from stainless steel duplex and/or super duplex casting (UNS J92205, UNS J93404 and UNS J93380), without using bake sand foundry process, shall attend the minimum requirements listed herein for design, production, inspection and acceptance.

A.8.1.1.2. The requirements listed herein are applicable for axial, ball, gate, globe and check type flanged valves, for all pressure classes, with NPS  $\geq 2$ .

#### A.8.1.2. DOCUMENTATION

A.8.1.2.1. The Data Book of the valve shall contain all certificates related to all parts, according:

- chemical requirements;
- mechanical tests (tension, hardness and impact);
- metallurgic tests (resistance to localized corrosion and metallography for phase treatment counting and thermal treatment of the pilot casting);
- inspection reports (visual, using penetrant liquid and radiography);
- all thermal treatments;
- all WPS for defect repairing, approved by PETROBRAS or by a Classification Society indicated by PETROBRAS.
- welders qualification certificates, for repairs execution;
- cavity mapping, for bigger repairs of each part of the valve;
- welding report, for repairs of each part of the valve.

#### A.8.1.3. CHEMICAL REQUIREMENTS

A.8.1.3.1. The duplex steel used for manufacturing casting valves, for use in piping specifications B16, C16, E16, G16 or G16P, shall be in accordance with ASME SA-995 or ASTM A 995 Grade 4A (UNS J92205 or ACI CD3MN).

A.8.1.3.2. The super duplex steel used for manufacturing casting valves, for use in piping specifications B12, C12, H12, G12, G12P or J12, shall be in accordance with ASME SA-995 or ASTM A 995 Grade 5A (UNS J93404 or ACI CE3MN).

A.8.1.3.3. The super duplex steel used for manufacturing casting valves, for use in piping specifications B13 or C13, shall be in accordance with ASME SA-995 or ASTM A 995 Grade 6A (UNS J93380 or CD3MWCuN).

A.8.1.3.4. The representative sample of the chemical requirements of the valve shall be collected from the pouring ladle.

A.8.1.3.5. A representative sample for carbon, sulfur and nitrogen contents shall be collected from the furnace before pouring into the ladle.

A.8.1.3.6. The addition of Niobium to the cast shall be avoided. The maximum allowable content of Niobium shall be 0,060% at the chemical requirements of the cast.

A.8.1.3.7. Adding Aluminum to the run shall be avoided. The maximum allowable content of Aluminum to the final chemical requirements shall 0,030%.

A.8.1.3.8. The levels of Nitrogen shall preferably be in the range of 0,20% up to 0,25%.

A.8.1.3.9. All consumables for the welding process shall have certification of their chemical requirements guaranteeing maximum levels of Niobium of 0,060%.

A.8.1.3.10. The chemical analysis of the elements shall be made in calibrated equipment according certified standards.

A.8.1.3.11. Whenever more than one ladle is used for one mold, the metal founded in each ladle shall be in accordance with the chemical specifications for the required level.

#### A.8.1.4. HEAT TREATMENT

A.8.1.4.1. The procedure for solubilization heat treatment used to the super duplex steel casting valves shall be in accordance with ASME SA-995 or ASTM A 995 Grade 5A (UNS J93404 or ACI CE3MN) and Grade 6A (UNS J93380 or ACI CD3MWCuN).

A.8.1.4.2. Solubilization heat treatment is the only acceptable treatment for production of the super duplex steel casting valves.

A.8.1.4.3. The maximum number of solubilization heat treatments allowed for a single valve is limited to three (03) at foundry and one (01) at machining shop. If more heat treatments are needed, the manufacturer shall submit it for PETROBRAS approval.

A.8.1.4.4. All heat treatments shall be monitored through thermocouples in the heat charge and in the furnace, and its register shall be inserted into the Data Book.

A.8.1.4.5. Welding repair is not allowed before heat treatment.

A.8.1.4.6. Whenever solubilization heat treatment is necessary after casting, it shall be performed in order to avoid distortions of the piece. It may be executed only one time.

A.8.1.4.7. The soaking time depends on the prior experience of the manufacturer, and shall guarantee full solubilization of the inter-metallic phases and the precipitates through the thickest dimension of the piece without causing dimensional distortions.

A.8.1.4.8. The pilot casting shall have possibility of extracting a test specimen for metallographic tests, which can be in any direction (longitudinal or transversal), representing a central session of the thickest part of the piece, according supplementary requirement S26.2 of ASTM A703, in order to verify the effectiveness and adjustment of the soaking time of the solubilization heat treatment. The results of this metallographic shall be part of the Data Book.

A.8.1.4.9. The result of the metallographic test shall indicate absence of inter-metallic phases and undesired precipitates – notably, the sigma phase, carbides and nitrates – in a 200X magnification, as well as indicate a level of ferrite in the range of 35 to 55%, according ASTM E 562.

A.8.1.4.10. For each casting with weight  $\geq 300$  kg, specimens for mechanical and metallurgical tests shall be attached, according ASTM A703. These test specimens shall remain attached to the casting until the last thermal treatment. For pieces with weight  $< 300$  kg, a test specimen per run is accepted.

#### A.8.1.5. MECHANICAL AND METALLURGICAL TESTS

A.8.1.5.1. The mechanical and metallurgical tests shall be done after the last the solubilization heat treatment, and before machining the casting.

A.8.1.5.2. The mechanical tests to be performed are tension, hardness and impact (Charpy-V) testing, according ASTM A370.

A.8.1.5.3. The test specimens shall be obtained from cast test blocks, according to ASTM A703. These blocks shall go through all the solubilization heat treatments before collecting the specimens for analysis.

A.8.1.5.4. One (01) test specimen shall be extracted for the tension test. The minimum acceptable values are according Table A.57 (ref. ASME SA-995 or ASTM A995).

Table A.57 – minimum values for tension tests

Grade	4A	5A	6A
UNS	J92205	J93404	J93380
Tensile Strength, ksi [Mpa] {kg/mm <sup>2</sup> }	90 [620] {63}	100 [690] {70}	100 [690] {70}
Yield Strength, ksi [Mpa] {kg/mm <sup>2</sup> }	60 [414] {42}	75 [515] {53}	65 [450] {46}
Elongation in 2" [50 mm], %	25	18	25

A.8.1.5.5. Three (03) test specimens shall be collected for the impact tests (Charpy-V). The tests shall be performed at a temperature of -46°C. The minimum values of absorbed energy shall be of 45J for an average of the three test specimens and 35J for each one of the test specimens.

A.8.1.5.6. The hardness tests shall be run on a test specimen collected from a test block, in a point representative of the central part of the thickest part of the casting, according to the supplementary requirement S26.2 of ASTM A703. The maximum hardness shall not be above 32 HRC (or 310 HB or 330 HV10), considering the average of three measurements. Castings with weight < 300 kg shall be tested individually and shall render specific hardness values less or equal to the pilot casting on the surface.

A.8.1.5.7. A test specimen shall be collected from the pilot casting, in order to perform the corrosion tests according ASTM G48 Method A. The test shall be run for 24 hours at a temperature of 50°C. The acceptance criteria shall be according to Grade 5A (UNS J93404 or CE3MN) and Grade 6A (UNS J93380 or CD3MWCuN):

- no pites located at 20 X magnification;
- loss of mass less than 4,0 g/m<sup>2</sup>.

A.8.1.5.8. The test to define the levels of ferrite shall be performed according to ASTM E562. The test specimen shall be collected from a cast test block connected to a casting that would represent a certain run. The acceptable range is 35 up to 55% of ferrite.

#### A.8.1.6. CASTING INSPECTION

##### A.8.1.6.1. VISUAL

A.8.1.6.1.1. visual inspection shall be made on all castings before and after each solubilization heat treatment, after pre-machining (whenever applicable) and the final machining.

A.8.1.6.1.2. all accessible surfaces, internal and/or external, shall be visually examined, comparing acceptable discontinuities and superficial finishing according MSS SP-55 or comparison rules of Steel Casting Research and Trading Association (SCRATA) adopted in ASTM A802, or other standard considered equivalent by a set deal between the manufacturer and PETROBRAS.

A.8.1.6.1.3. the levels of acceptance for visual inspections are set in ASTM A802, and are:

- level II, for non-machined surfaces;
- level III, for surfaces to be machined, as long as the machining completely eliminates the discontinuities.

A.8.1.6.1.4. all castings that presents, in one or more surfaces, independent of how serious or how extensive the defects are, or whether it allows repairs using welding or not, the following defects shall be considered UNACCEPTABLE:

- chaplet - discontinuity due to the incomplete fusion of the supports of chills and cores;

- shrinkage - cavity resulting from contraction while solidifying;
- shift - discontinuity due to displacement of contact edges of the molding boxes;
- misrun - insufficient founded metal in the casting;
- shut metal - discontinuity due to the encounter of two currents of metal that have not been well mixed;
- veins - discontinuity due to movement or cracking of the sand mold;
- rat tail - depression on the surface of the piece caused by waves or failure in the mold surface;
- internal chills - discontinuity caused by incomplete fusion of devices used to increase the cooling rate in determined places.

#### A.8.1.7. LIQUID PENETRANT INSPECTION (LPI)

A.8.1.7.1. LPI shall be performed by Level 2 inspectors qualified by the “Sistema de Nacional de Qualificação e Certificação” (National System of Qualification and Certification) in Non Destructive Testing (SNQC/END), or by another bureau according to ISO 9712 or EN 473.

A.8.1.7.2. LPI shall be performed on every produced casting, on all accessible surfaces (internally and/or externally), after the final machining. All castings that make up the valves of the same order shall undergo inspection using Liquid penetrant.

A.8.1.7.3. LPI shall be performed according to ASTM E165.

A.8.1.7.4. indications shall be classified according to APPENDIX 8 (8-3) of ASME SEC VIII Div. 1.

A.8.1.7.5. The acceptance criteria shall be according to ASME SEC VIII DIV 1 APPENDIX 7.

#### A.8.1.8. RADIOGRAPHY OF VALVE PARTS AND PILOT CASTING

A.8.1.8.1. radiographic inspection shall be executed by Level 2 inspectors qualified by the “Sistema de Nacional de Qualificação e Certificação” (National System of Qualification and Certification) in Non Destructive Testing (SNQC/END), or by certification according to ISO 9712 or EN 473.

A.8.1.8.2. radiographic inspection shall be performed on the pilot casting (body, cap and shutter), after conclusion of heat treatment. For parts which pressure classes are 900 and above, it is mandatory to perform radiographic inspection on 100% of the final pieces, in the critical regions defined in ASME B16.34.

A.8.1.8.3. radiographic inspection shall be performed according to ASTM E94 and ASTM E1030.

A.8.1.8.4. The list of parts to be radiographed and the acceptance criteria shall be according to ASME B16.34.

A.8.1.8.5. If all indications are classified as ACCEPTABLE, no other piece than the pilot casting shall be radiographed.

A.8.1.8.6. If one or more conditions were classified UNACCEPTABLE, the pilot casting shall be fixed or scrapped, a report shall be issued with causes analyses and solutions, and another piece shall be radiographed. If the second piece is approved, no more piece needs to be radiographed. If the second piece also presents UNACCEPTABLE indications, all pieces equal to the pilot casting of the order shall be radiographed in the areas rejected for the pilot casting and for the second casting. The second casting and the subsequent piece of the order shall be repaired whenever identified an unacceptable indication, otherwise it shall be rejected.

Table A.58 - maximum levels of severity by defect by thickness

Defects by Thickness	Thickness < 2”	2 ≤ Thickness < 4 1/2”	4 1/2” ≤ Thickness < 12”
----------------------	----------------	------------------------	--------------------------

Standards	ASTM E446	ASTM E186	ASTM E280
Porosity (A)	A2	A3	A3
Sand or Slag (B)	B3	B3	B3
Shrinkage Porosity (CA)	CA2	CA3	CA3
Shrinkage Porosity (CB)	CB3	CB3	CB3
Shrinkage Porosity (CC)	CC3	CC3	CC3
Shrinkage Porosity (CD)	CD3	-	-
Cracks (D)	None	None	None
Shrinkage Cracks (E)	None	None	None
Inserts (F)	None	None	None

#### A.8.1.9. ULTRASONIC INSPECTION

A.8.1.9.1. Ultrasonic inspection shall be executed by Level 2 inspectors qualified by the “Sistema de Nacional de Qualificação e Certificação” (National System of Qualification and Certification) in Non Destructive Testing (SNQC/END), or by certification according to ISO 9712 or EN 473.

A.8.1.9.2. Ultrasonic inspection shall be performed according to ASTM A388 (forgings) and ASTM A609 (castings).

A.8.1.9.3. Acceptance criteria shall be according to ASME B16.34.

#### A.8.1.10. REPAIRS

A.8.1.10.1. All kind of repairs shall be made by welding.

A.8.1.10.2. All repairs shall have a specific WPS approved by welding inspector level 2, according to type of equipment, and by a Classification Society indicated by PETROBRAS. This WPS shall be based on ASTM A488.

A.8.1.10.3. The WPS and the qualification of the welder shall be according to acceptance criteria established in I-ET-3010.00-1200-955-P4X-001.

A.8.1.10.4. The repair shall be witnessed by a Level I welding inspector.

A.8.1.10.5. Before any repair, the surface shall be inspected by visual and preferably magnetic particle and liquid penetrant inspection.

A.8.1.10.6. Twenty-four hours (for hydrogen diffusion) after the last welding repair, it shall be repeated the same NDT used to identify the defect. For extensions over 50 mm length and over 20% thickness depth a ultrasonic test or radiography shall be executed. Acceptance criteria shall be according to ASME B16.34.

A.8.1.10.7. It is mandatory to perform post weld heat treatment for carbon steel or solubilization on stainless steel when:

A.8.1.10.7.1. The repair is demanded after leaking in the hydrostatic test;

A.8.1.10.7.2. The cavity after the repair preparation is over 20% of thickness depth or 25 mm, whichever is smaller;

A.8.1.10.7.3. The extension (area) of the cavity is bigger than 65 cm<sup>2</sup>.



A.8.1.10.8. Test Specimens for Counter-Sample - Chemical Analysis and Mechanical Testing: the minimum period established for storage, by the foundry, of test specimens for sample are twelve (12) months.

#### A.8.1.11. MACHINING

A.8.1.11.1. The machining of the casting shall only be executed after heat treatment.

A.8.1.11.2. No kind of machining may be done after hydrostatic test.

A.8.1.11.3. Machined surfaces shall be according to valve design as tolerance and rugosity.

A.8.1.11.4. No kind of metallurgical changing may occur caused by heating during machining. If necessary, shall be a metallographic replica exam.

A.8.1.11.5. Liquid penetrant on seal surface shall be ZERO defect.

### A.8.2. COATINGS

#### A.8.2.1. METALLIC COATING

##### A.8.2.1.1. ELECTROLESS NICKEL PLATING (ENP)

A.8.2.1.1.1. Whenever specified in the VDS, it shall be applied on the indicated parts an ENP coating obtained by chemical reactions leading to a plating composed of 90% Nickel and 10% Phosphorus. This coating shall be in accordance with ASTM B 733 attending classification SC4, Type V, heat treatment Class 2.

A.8.2.1.1.2. The minimum thickness of the ENP coating shall be 0,003 inch (75 µm).

A.8.2.1.1.3. All components shall be traceable for the details of the coating procedure, coating conditions and date of application.

A.8.2.1.1.4. The manufacturer shall issue inspection certificates of the ENP coating, and each certificate shall identify the plant where the treatment is performed and the history of the process. Also, it shall list all serial numbers of the parts coated together with the material grades and the overall geometry of those parts.

##### A.8.2.1.2. COBALT-CHROMIUM (CO-CR) WELD OVERLAY

A.8.2.1.2.1. Whenever specified in the VDS the term Stellite, it shall be applied a weld overlay of cobalt-chromium (Co-Cr) alloy on indicated parts.

A.8.2.1.2.2. The specification of the cobalt-chromium (Co-Cr) alloy shall fulfil the requirements of the design standard indicated in the VDS.

A.8.2.1.2.3. For valves with  $DN < 2$ , which is not possible to apply cobalt-chromium (Co-Cr) weld overlay, the manufacturer shall consider to use integral parts of cobalt-chromium (Co-Cr) alloy.

A.8.2.1.2.4. For the parts which materials are made of solid cobalt-chromium (Co-Cr) alloy there is no need to apply an overlay.

##### A.8.2.1.3. STAINLESS STEEL (AISI 316) WELD OVERLAY

A.8.2.1.3.1. Whenever specified in the VDS, it shall be applied a minimum of 3,0 mm thick weld overlay in stainless steel grade 316L on seat pockets and stem seal contact faces on the body.

A.8.2.1.3.2. For floating ball valves, this requirement is not applicable to the seat pockets as soon as the seat ring is made of an integral, solid thermoplastic material (i.e.: valves having a fixed seat), but it applies to stem sealing areas in all cases (for floating ball valves having also a floating seat design, the seat-to-body sealing area shall consequently

be overlaid).

A.8.2.1.3.3. For valves with DN < 2, which is not possible to apply stainless steel weld overlay, the manufacturer shall consider using integral parts of stainless steel or CRA alloy.

A.8.2.1.3.4. For the parts which materials are made of stainless steel, duplex, super duplex or solid Alloy 625 there is no need to apply an overlay.

A.8.2.1.3.5. Dilution on welded surface shall not exceed 10% of base metal.

#### A.8.2.1.4. NICKEL ALLOY (INCONEL 625) WELD OVERLAY

A.8.2.1.4.1. Whenever specified in the VDS the term Alloy 625, it shall be applied a weld overlay of a nickel alloy UNS N06625 on indicated parts.

A.8.2.1.4.2. Whenever specified in the VDS full clad, it shall be applied a weld overlay of Nickel Alloy (Alloy 625) Weld Overlay on all wetted parts, including flange facings up to the outside diameter of all valve flanges.

A.8.2.1.4.3. The areas of such parts that shall be welded are indicated in the VDS. The manufacturer shall attend to the requirement of partial or full cladding.

A.8.2.1.4.4. The weld overlay thickness shall be sufficient in order to obtain a minimum of 3,0 mm thick protective layer in the final machined condition.

A.8.2.1.4.5. For valves with DN < 2, which is not possible to apply Alloy 625 weld overlay, the manufacturer shall consider to use integral parts of Alloy 625.

A.8.2.1.4.6. For the parts which materials are made of solid Alloy 625 there is no need to apply an overlay.

A.8.2.1.4.7. Dilution on welded surface shall not exceed 10% of base metal.

### A.8.2.2. HARD COATING

#### A.8.2.2.1. CHROMIUM ELECTROPLATE

A.8.2.2.1.1. Whenever specified hard coating in the VDS, a hard coating of chromium electroplate may be applied on the indicated parts of a metal-to-metal ball valve, as described in Table A.33.

#### A.8.2.2.2. CHROME CARBIDE

A.8.2.2.2.1. Whenever specified hard coating in the VDS, a hard coating of chrome carbide may be applied on the indicated parts.

A.8.2.2.2.2. When applicable, hard coating of chrome carbide shall be applied by High Velocity Oxy-Fuel (HVOF) process.

A.8.2.2.2.3. The hard coating of chrome carbide shall achieve a minimum thickness of 200 µm after grinding and lapping.

A.8.2.2.2.4. The hard coating shall be carefully applied and inspected to ensure that the finish is smooth, fine grained, adherent, and free from blisters, pits, nodules, indication of burning, edge buildup, and other defects.

A.8.2.2.2.5. The hard Coating thickness shall be measured to confirm the results of it against the specified thickness.

#### A.8.2.2.3. TUNGSTEN CARBIDE

A.8.2.2.3.1. Whenever specified hard coating in the VDS, a hard coating of tungsten carbide may be applied on the indicated parts.

A.8.2.2.3.2. When applicable, hard coating of tungsten carbide shall be applied by High Velocity Oxy-Fuel (HVOF)

process.

A.8.2.2.3.3. The hard coating of tungsten carbide shall achieve a minimum thickness of 200 µm after grinding and lapping.

A.8.2.2.3.4. The hard coating shall be carefully applied and inspected to ensure that the finish is smooth, fine grained, adherent, and free from blisters, pits, nodules, indication of burning, edge buildup, and other defects.

A.8.2.2.3.5. The hard coating thickness shall be measured to confirm the results of it against the specified thickness.

#### A.8.2.2.4. CHROME-NICKEL SPRAY AND FUSE

A.8.2.2.4.1. Whenever specified hard coating in the VDS, a hard coating of chrome-nickel basis with metallurgical bonding may be applied on the indicated parts.

A.8.2.2.4.2. When applicable, hard coating of chrome-nickel basis with metallurgical bonding shall be applied by Flame Spray and Fuse process.

A.8.2.2.4.3. The hard coating of chrome-nickel spray and fuse shall achieve a minimum thickness of 500 µm after grinding and lapping.

A.8.2.2.4.4. The hard coating shall be carefully applied and inspected to ensure that the finish is smooth, fine grained, adherent, and free from blisters, pits, nodules, indication of burning, edge buildup, and other defects.

A.8.2.2.4.5. The hard Coating thickness shall be measured to confirm the results of it against the specified thickness.

### A.8.2.3. NON-METALLIC COATING

#### A.8.2.3.1. ORGANIC COATING

A.8.2.3.1.1. The use of valves with organic coating may be considered as option for specific service applications, such as with seawater service.

A.8.2.3.1.2. Whenever applicable, the pipe specification (*spec*) may present an organic coated valve code as an option.

A.8.2.3.1.3. Only ball, gate and globe valve types classified as VSL-1 and VSL-2 may consider the use of organic coating.

A.8.2.3.1.4. The VDS of organic coated valve shall indicate/allow, as principle, the application of organic coating only in the body/closure material of the valve.

A.8.2.3.1.5. For small size valves (e.g.: NPS < 3), when organic coating is not applicable, the body may be made of a material with the same corrosion resistance of the materials specified for the internals.

A.8.2.3.1.6. The specification of the organic coating shall be according to Annex F of this document.

A.8.2.3.1.7. RTJ flanges may be organic coated, except the ring groove which shall attend the orientation indicated in the pipe specification (*spec*).

#### A.8.2.3.2. POLYAMIDE (PA) COATING

A.8.2.3.2.1. The use of valves with polyamide (PA) coating is no longer considered as option for specific service applications, such as with seawater service.

A.8.2.3.2.2. Superduplex is now used instead of polyamide coating.

A.8.2.3.2.3. Only concentric butterfly valves (Category A) classified as VSL-1 were considered to use of polyamide (PA) coating, but the damage of the coating is the reason for the substitution of polyamide coating to superduplex.

A.8.2.3.2.4. The stem shall be in superduplex for butterfly valves category A with disc in superduplex.

### A.8.3. ALTERNATIVE MATERIALS

A.8.3.1. All materials listed in the VDS shall be considered as standardized materials for valve parts, but are not exclusive solutions. Therefore, the valve manufacturer may propose alternative materials (equivalent or better), conditioned to PETROBRAS approval.

A.8.3.2. For a material to be accepted as equivalent or better, it shall have the same or better mechanical (i.e. yield strength, hardness, etc.) and anti-corrosive properties (measured by PREN), be suitable for temperature range presented in the VDS whilst not being susceptible to phenomenon such as brittle fracture or stress corrosion cracking.

A.8.3.3. Charpy impact testing is required for all materials, considering minimum temperature listed in ASME B31.3, section 323 or as listed in the VDS, whichever is lower. All metallic materials shall be suitable for minimum temperature service of  $-29^{\circ}\text{C}$ .

A.8.3.4. Some examples of alternative materials are:

A.8.3.4.1. For pressure-containing parts, forging materials are acceptable in place of casting materials, but not vice-versa.

A.8.3.4.2. For remaining internal parts (i.e.: non pressure-containing), forgings and castings are interchangeable as long as they have the same desired properties (i.e.: mechanical properties, corrosion resistance, maximum or minimum hardness, and other properties as applicable).

A.8.3.4.3. Superduplex (UNS S32760) may be used as replacement for duplex (UNS S31803), but not vice-versa.

A.8.3.4.4. Superduplex and duplex steels shall not be used for chlorinated seawater services (SW).

A.8.3.4.5. Nickel Aluminum Bronze (UNS C95800) may be used as replacement for bronze B62 (UNS C83600), but not vice-versa.

A.8.3.4.6. Higher mechanical strength alloys such as ASTM A694 F60 or ASTM A694 F65 (see A.6.1.3.3.) are acceptable instead of ASTM A105 or ASTM A216 Gr WCB. For Nickel-based alloy clad valves used for sour service, the base material shall be NACE compliant.

A.8.3.4.7. Superduplex and duplex steels may be replaced by carbon steel with 3 mm of Alloy 625 overlay, and vice-versa if low temperature requirements are satisfied. Additionally, the pressure-temperature rating shall be validated.

A.8.3.4.8. Austenitic steels with PREN number less than that of 316/316L shall not be used on offshore facilities (e.g.: AISI 304 and AISI 304L stainless steel materials shall not be used).

A.8.3.4.9. Internal parts made of martensitic stainless steels (e.g.: AISI 410) may be replaced by higher chromium alloys such as ASTM A564 Gr 630 H1150 (17-4PH), superduplex or duplex steels.

A.8.3.4.10. ASTM A350 LF3 may be replaced with ASTM A350 LF2 CL1, in case minimum temperature is above  $-46^{\circ}\text{C}$ .

A.8.3.4.11. Internal parts made of austenitic stainless steels may be replaced with higher chromium alloys, if low temperature requirements are satisfied:

- Down to  $-46^{\circ}\text{C}$ : ASTM A350 LF2 CL1 with 3 mm of Alloy 625 overlay or ASTM A564 Gr 630 H1150 (17-4PH);
- Down to  $-51^{\circ}\text{C}$ : Duplex (UNS S31803) or Superduplex (UNS S32760);
- Down to  $-100^{\circ}\text{C}$ : ASTM A350 LF3 with 3 mm of Alloy 625 overlay, ASTM A522 type I with 3 mm of alloy 625 overlay or full inconel parts.

A.8.3.4.12. Low temperature carbon steel parts (i.e.: ASTM A350 LF2, ASTM A350 LF3) may be used in lieu of regular carbon steel parts (e.g.: ASTM A105, ASTM A216 WCB).

#### **A.8.4. DRAIN, VENTS AND INJECTION CONNECTIONS**

A.8.4.1.1. For welded plugs the material shall be the same grade as the body.

A.8.4.1.2. For non welded removable plugs the material shall be the same material as the trim, minimum SS316L.

A.8.4.1.3. To prevent galling, threads shall be coated with silver plate.

A.8.4.1.4. Drains, vents and injection connections shall comply with IOGP S 562.

### **A.9. INSPECTION & TESTING**

#### **A.9.1. INSPECTION REQUIREMENTS**

##### **A.9.2.1. INSPECTION AND TESTING PLAN (ITP)**

A.9.1.1.1. The ITP shall be issued by the supplier and submitted to PETROBRAS or EPC contractor approval.

A.9.1.1.2. The ITP shall allow the identification of stages, through the valve production cycle, where it shall be done checks or inspections, including those carried out by material or service suppliers.

A.9.1.1.3. The ITP shall indicate the types of examinations, tests or checks to be made, as well as procedures and/or applicable instructions, acceptance criteria and issued records.

A.9.1.1.4. The ITP shall contain register of critical quotas as defined by the manufacturer, including, at least, standardized quotas in the construction and design standards of valves.

A.9.1.1.5. The ITP shall contain the procedures and instructions for inspection of all expected activities.

A.9.1.1.6. The inspection shall be performed by PETROBRAS or EPC contractor.

##### **A.9.2.2. RECEIVING INSPECTION**

A.9.1.2.1. The receiving inspection shall be performed without causing damages to the package and without compromising the preservation of the valves.

A.9.1.2.2. It shall be checked the valve and its components as the Data Book, identification (e.g. valve serial number, actuator serial number, pressure class, etc.) and manufacturer manual for handling, storage and preservation.

A.9.1.2.3. After verifying the documentation and attesting its conformity, the packed shall be stored according to item A.10.

##### **A.9.2.3. NON DESTRUCTIVE TESTING (NDT)**

The execution of NDT shall follow specific requirements, according to type of material:

###### **A.9.1.3.1. CAST IRON AND BRASS VALVES:**

- 100% visual inspection;
- for body and bonnet made of cast iron or forgings, pressure class 150 and 300, magnetic particle testing is required at least in 20% of each batch material.

###### **A.9.1.3.2. CARBON STEEL VALVES:**

- 100% visual inspection;
- for body and bonnet made of forgings, pressure class 600, 900, 1500, 2500 and 10.000psi, magnetic particle testing is required in 100% of each batch material;
- for body and bonnet made of casting, pressure class 600, 900, 1500, 2500 and 10.000psi, radiographic examination in critical areas is required in 100% of each batch material.

A.9.1.3.3. CARBON ALLOY STEEL VALVES:

a) ASTM A522 Type I (forging):

- 100% visual inspection;
- for body and bonnet made of forgings, pressure class 150 and 300, liquid penetrant inspection is required at least in 20% of each batch material;
- for body and bonnet made of forging, pressure class 900, 1500, 2500 and 10.000psi, liquid penetrant inspection is required in 100% of each batch material;
- for body and bonnet made of castings, pressure class 900, 1500, 2500 and 10.000psi, radiographic examination is required in 100% in critical areas.

Table A.59 – Chemical composition for ASTM A522 – Type I

Chemical Composition	Carbon (max.)	Manganese	Phosphorus	Sulfur	Silicon	Nickel
ASTM A522 Type I	0,06	0,59	< 0,005	< 0,001	0,28	9,08

A.9.1.3.4. STAINLESS STEEL VALVES:

- 100% visual inspection;
- for body and bonnet made of forgings, pressure class 150 and 300, liquid penetrant inspection is required at least in 20% of each batch material;
- for body and bonnet made of forgings, pressure class 900, 1500, 2500 and 10.000psi, liquid penetrant inspection is required in 100% of each batch material;
- for body and bonnet made of casting, pressure class 900, 1500, 2500 and 10.000psi, radiographic examination is required in 100% in critical areas.

A.9.1.3.5. STAINLESS STEEL DUPLEX AND SUPER DUPLEX VALVES:

- 100% visual inspection;
- for body and bonnet made of forgings, pressure class 150 and 300, liquid penetrant inspection is required at least in 20% of each batch material;
- for body and bonnet made of forgings, pressure class 900, 1500, 2500 and above, liquid penetrant inspection is required in 100% of each batch material;
- for body and bonnet made of casting, pressure class 900, 1500, 2500 and above, radiographic examination is required in 100% in critical areas.

A.9.1.3.6. Additional Requirements:

- all valves specified for hydrogen sulfide service shall be in strict accordance with the requirements of the ISO 15156;
- visual inspection shall be according to ASME BPV section V. The acceptance criteria shall be according to MSS SP-55 specification;
- liquid penetrant and magnetic particles testing shall be according to ASME BPV section V. The acceptance criteria shall be according to ASME B16.34 specification for class pressure up to 600#. For higher class pressures the acceptance criteria shall be according to ASME B16.4, with the exception that no linear indication shall be accepted;
- visual inspection shall be according to ASME BPV section V. The acceptance criteria shall be according to ASME B16.34 specification;
- radiographic examination shall be according to ASME BPV section V and ASTM E94. The acceptance criteria shall be according to ASME B16.34 specification;
- for castings valves NDT examinations shall focus on critical areas.

### A.9.2. DESIGN VALIDATION

A.9.2.1. The design validation of a valve is requested according its VSL classification, as presented as follows:

Table A.60 – Design validation requirements according VSL classification

VSL Classification	VSL-1	VSL-2	VSL-3	VSL-4
Design Validation	No	Design analytical approval	Design validation test approval (PVT)	

A.9.2.2. For VSL-1 valves, no design validation is required. In this case, the manufacturer shall perform the design and manufacture the valve attending all requirements listed in the applicable standards (e.g.: API 6D, API 6A, etc.).

A.9.2.3. For VSL-2 valves, design validation is required at documentation level. In this case, the manufacturer shall have an analytical approval of the valve design. To attend this kind of design validation, the manufacturer shall submit for PETROBRAS approval:

- Certificate of approval, issued by a 3<sup>rd</sup> party, referred to an analytical approval of the valve design, according normative requirements (e.g.: NBR 15827, API 6D, API 6A, API 600, API 609, etc.); or
- A valid API monogram of the valve design, complying to all normative requirements of quality and design.

NOTE: In case the manufacturer has already performed a PVT test in the past on a representative prototype of the valve design or on a valve which scaling may be considered valid, the requirement of design analytical approval may be demonstrated by the certificate of approval. This certificate, referred to the execution to this PVT test, shall be issued by a 3<sup>rd</sup> party.

A.9.2.4. For VSL-3 and VSL-4 valves, design validation is required at PVT test execution level. In this case, the manufacturer shall perform all PVT tests on a representative prototype of the valve that will be supplied.



NOTE: The manufacturer is free of charge on performing the PVT test, in case it is presented a certificate of approval, issued by 3<sup>rd</sup> party, referred on a PVT test performed in the past, on a representative prototype of the valve that will be supplied or on a valve which scaling may be considered valid.

A.9.2.5. In the case of PVT test execution, the following Standards may be considered to the test:

- NBR 15827; or
- API 6A, considering PSL 3G, PR2 (Appendix F); or
- API 6AV1.

NOTE: In case of missing technical requirements, including acceptance criteria (e.g.: ball valve on API 6A), the PVT test procedure shall be elaborated from better suited standards such as NBR 15827, and submitted to PETROBRAS approval.

A.9.2.6. For a supply of a fire tested valve, the manufacturer shall also present a certificate of approval, issued by 3<sup>rd</sup> party, complying to ISO 10497.

A.9.2.7. For a supply of a fugitive emissions valve, the manufacturer shall also present a certificate of approval, issued by 3<sup>rd</sup> party, complying to ISO 15848.

### **A.9.3. FACTORY ACCEPTANCE TEST (FAT) REQUIREMENTS**

#### **A.9.4.1. TEST MEDIUM**

A.9.3.1.1. The manufacturer shall consider the use of the following test medium:

A.9.3.1.1.1. For all tests with liquid: It shall be used fresh water with an addition of corrosion inhibitor.

NOTE: The chloride content of test water in contact with austenitic and duplex stainless steel wetted components of valves shall not exceed 30 µg/g (30 ppm by mass) and the water temperature shall not be greater than 38°C (100°F) during the testing period.

A.9.3.1.1.2. For high pressure gas tests: It shall be used dry nitrogen (N<sub>2</sub>).

A.9.3.1.1.3. For low pressure gas tests: It may be used dry air or nitrogen (N<sub>2</sub>).

#### **A.9.4.2. TEST BENCH**

A.9.3.2.1. The manufacturer shall attend all requirements herein stated for the design and assembly of the test bench dedicated to perform the FAT tests of the valve / actuator.

A.9.3.2.2. It shall be considered, as minimum, the use of the following equipment:

- a) Test Panel with devices for manual and automatic operation, provided of pressure transmitters, digital indicators or controllers, pressure meters, solenoid valves, relays, end-of-stroke indicators, cycles counter, etc., as well as hydraulic systems (hydraulic units, etc.) compatible with the flows and test pressure levels for the valve / actuator which will be tested.
- b) Fittings and tubing of stainless steel.
- c) High pressure hoses.
- d) Torque tool.



- e) Data acquisition system, with capacity to adequately record the values of pressure and / or torque during test execution.

A.9.3.2.3. The manufacturer shall take attention to the adequacy of protection for personnel carrying out the testing, in the event of failure of a valve, connection or equipment during the test. Additional caution shall be taken whenever high pressure gas tests are required.

#### **A.9.4.3. MONITORING PORTS FOR ACTUATED VALVES**

A.9.3.3.1. During execution of any valve cycle, the following pressure ports shall be monitored / registered:

- a) Valve upstream pressure
- b) Valve downstream pressure
- c) Valve body pressure
- d) Actuator input (e.g.: hydraulic or pneumatic pressure, electric current)
- e) Valve stroke

#### **A.9.4.4. LEAKAGE IDENTIFICATION**

A.9.3.4.1. The test bench shall have the capacity to monitor eventual leakages and allow to measure the volume in order to allow verification of the acceptance criteria.

A.9.3.4.2. Hydraulic lines must be, whenever technically possible, built with short stainless steel tubing, to increase the sensitivity to leakage detection. With the same purpose a procedure for purging the air of the valve body, the actuator and the test panel must be foreseen. This procedure shall be approved by PETROBRAS.

A.9.3.4.3. During sealing tests with liquid, whenever visual observation of leakage in a direct way is not possible, leakages can be monitored by pressure variation.

A.9.3.4.4. In case of leakage identification by pressure variation, one example of a method of quantifying sensitivity of the test bench would be the creation of a "leakage", small and controlled, where the leaked volume variation would be co-related with the pressure drop generated by this "leakage", for each test condition (pressure value, upstream lines, downstream, ambient temperature, etc.).

A.9.3.4.5. Detection of a leakage shall be associated with the identification of a continuous pressure variation, without occurring its stabilization along the time and since the effects of temperature variation can be disregarded (or compensated). Thus, the pressure drop in an upstream line or pressure rise in a downstream line, without stabilization of these pressure variations shall be considered as leakage.

A.9.3.4.6. In case of leakage identification by using level variation in a capillary, its diameter shall be compatible with the capacity of identifying small leakages / volumes.

A.9.3.4.7. Pneumatic shell test shall be performed using inert gas, such as mixture of 99 % nitrogen with a 1 % helium, tracer measured using a mass spectrometer, in order to guarantee leakage detection. Alternatively, if nitrogen (100%) is used as test medium, the valve shall be submerged.

A.9.3.4.8. In case of monitoring gas leakage at the pressure ports, for higher and constant leakages it shall be considered the use of flowmeters operating inside 20% to 80% of the nominal capacity of it.

A.9.3.4.9. For monitoring gas leakage on pressure ports for smaller or inconstant leakages it shall be performed by

using scale burette where a flexible hose is inserted totally on a burette (or at least above the meniscus) and the set is submerged on a transparent aquarium filled with clean water. Monitoring of leakage shall be done by registering the displacement of the meniscus line inside the burette, which can be seen through the aquarium.

A.9.3.4.10. Before each type of test, the manufacturer shall present the test bench set-up in order to demonstrate that it is assembled on a correct way to perform the tests and monitor eventual leakages. The following items shall be concerned during this presentation:

- a) It shall be verified that the pressure source is connected to the correct pressure port.
- b) It shall be verified that all test devices are properly assembled, such as if flanges and fittings are tightened, check of instrumentation valves position (fully opened or fully closed), identification of hoses (which shall be in a good shape, without creases, holes or tears), etc.;
- c) Before gas tests, if the valve is completely purged.
- d) Check of safety rules appliance, prior to beginning the tests.

**A.9.4.5. FAT SEQUENCE**

A.9.3.5.1. All manual and actuated valves shall be subjected to a Factory Acceptance Test (FAT) prior to delivery and/or shipping the valve.

A.9.3.5.2. It shall be considered the execution of FAT for the valve and its actuator.

A.9.3.5.3. Otherwise agreed, the FAT shall be performed with the actuator assembled onto the valve.

A.9.3.5.4. A functional test of valve + actuator shall be considered in order to guarantee adequate performance of the set.

A.9.3.5.5. Valves wich design contains fugitive emissions requirement shall also perform additional FAT tests according to item A.9.4.6.

A.9.3.5.6. HIPPS valves shall also perform additional FAT tests according to item A.9.4.7.

A.9.3.5.7. Any conflict between contract requirements and this document shall be presented for PETROBRAS evaluation.

A.9.3.5.8. The FAT of bronze globe valves shall follow MS SP-80. The FAT of other globe valves shall follow BS 1873 / BS 12266 or API 623 requirements, as applicable, and applicable tests listed in these Standards shall be performed.

A.9.3.5.9. The FAT of butterfly valves (except to the triple offset design) shall follow API 609 / API 598 requirements, and applicable tests listed in these Standards shall be performed, including the optional high-pressure closure test.

A.9.3.5.10. The FAT of ball, gate, check, plug, axial and triple offset butterfly valves shall be as bellow. The FAT of ball and gate valves complying with IOGP S-562 and S-611 shall be according to A.7.1.8 and A.7.2.5, repectively.

A.9.3.5.10.1. Pressure tests according the respective QSL requirement for each VSL classification:

Table A.61 – QSL / PSL requirement according VSL classification

VSL Requirements	VSL-1	VSL-2 (not for hydrocarbon)	VSL-2 (with hydrocarbon)	VSL-3	VSL-4
<b>QSL</b> (According API 6D)	QSL-2	QSL-2	QSL-3	QSL-3	QSL-4

<b>PSL</b> (According API 6A)	NA	PSL-3 or PSL-3G as applicable	PSL-3 or PSL-3G as applicable	PSL-4	PSL-4
----------------------------------	----	----------------------------------	----------------------------------	-------	-------

- a) For VSL-1 valves, it shall be performed pressure tests according to API 6D QSL-2 requirements.
- b) For VSL-2 valves, it shall be performed pressure tests according to API 6D QSL-3 requirements. For liquid service application, it shall be performed pressure tests according to API 6D QSL-2 requirements.
- c) For VSL-3 valves, it shall be performed pressure tests according to API 6D QSL-3 requirements.
- d) For VSL-4 valves, it shall be performed pressure tests according to API 6D QSL-4 requirements.

A.9.3.5.10.2. In addition to the pressure tests required by Table A.61, the FAT of ball valves shall consider the execution of the following supplementary tests listed in Annex H of API 6D: H.5, H.6, H.7, H.8, H.9, H.11.

NOTE: Otherwise agreed, the supplementary tests H.9 and H.11 shall be performed using gas as test medium.

A.9.3.5.10.3. The acceptable leakage rate for the tests shall be according to API 6D, except to:

- a) Hydrostatic seat test and low-pressure gas seat test of metal seated valves: the acceptable leakage shall be ISO 5208 Rate B. For DBB tests the acceptable leakage is 2 X B.
- b) High-pressure gas seat test of metal seated valves: the acceptable leakage rate shall be 2 X C (two times ISO 5208 Rate C). For DBB tests the acceptable leakage is 4 X C.

NOTE: Whenever DBB feature is required for the valve design at closed or closed & opened position, it shall be considered the execution of DBB test on both conditions.

- c) Triple offset butterfly valves: The acceptable leakage rate for all HP/LP sealing (i.e.: seat) tests shall be ISO 5208 Rate A.

A.9.3.5.10.4. Prior to perform the drive train strength test, listed in item H.7 of API 6D, the manufacturer shall provide the following information:

- a) Drive train engineering data (i.e.: stem calculation), demonstrating that the design thrust or torque for all drive train calculations is at least two times the breakaway thrust or torque of the valve (i.e.: maximum thrust or torque required to operate a valve at maximum pressure differential).
- b) Actuator engineering data (e.g.: gearbox, hydraulic, etc.), demonstrating that proper safety factor has been taken into account.
- c) Test fixture design data, in order to guarantee that the test fixture used to block the obturator is able to withstand the loads of the test and it would not damage the surface of the parts in contact (i.e.: ball / seats edges, sealing region).
- d) The selected torque value (acc. item H.7 of API 6D) that will be applied on the drive train strength test. If the valve actuator (e.g.: gearbox, hydraulic, etc.) is used to generate the torque test, it shall be checked the values of maximum output torque of the actuator and the selected torque value for the test, in order to confirm its compatibility.

NOTE: The drive train strength test shall be performed prior to the sealing tests (i.e.: seat test) and it may be done in only one valve of the lot, per nominal, per actuator type (e.g.: gearbox, hydraulic, etc.), and per pressure class, conditioned to:

- Agreement by test inspector of all documentation listed in this item.
- No failures on the drive train strength tests. If one valve of the lot failures on the drive train strength, the others valves with same design premise shall perform the test.

**A.9.4.6. FUGITIVE EMISSIONS FAT**

A.9.3.6.1. Whenever specified in the VDS that the valve shall be fugitive emissions approved, a minimum of one valve of the lot shall be selected at random from each production lot of valves per valve type, pressure class and nominal size, and tested according to ISO 15848 Part 2.

A.9.3.6.2. The manufacturer shall prepare specific Factory Acceptance Test (FAT) procedure, according to ISO 15848 Part 2, and submit for PETROBRAS approval.

A.9.3.6.3. The “Tightness Class” shall be according:

Table A.62 – Tightness class for stem seals - fugitive emissions (ref.: ISO 15848 Part 1)

<b>Tightness Class (Stem seals)</b>	<b>Measured Leak Rate <sup>1</sup></b>
A	≤ 50
B	≤ 100
C	≤ 1000
<sup>1</sup> Expressed in ppmv measured with the sniffing method as defined in ISO 15848 Part 1 - Annex B (1 ppmv = 1 ml/m <sup>3</sup> = 1 cm <sup>3</sup> /m <sup>3</sup> )	

Table A.63 – Tightness class for body seals - fugitive emissions (ref.: ISO 15848 Part 1)

<b>Measured concentration (Body seals)</b>	≤ 50 <sup>1</sup>
<sup>1</sup> Expressed in ppmv measured with the sniffing method as defined in ISO 15848 Part 1 - Annex B (1 ppmv = 1 ml/m <sup>3</sup> = 1 cm <sup>3</sup> /m <sup>3</sup> )	

A.9.3.6.4. The FAT report shall be according to item 7 of ISO 15848 Part 1.

A.9.3.6.5. Valves shall comply with stem tightness class BH.

**A.9.4.7. HIPPS VALVE IN PLACE TEST**

A.9.3.7.1. All HIPPS valves shall be able to pass through a regular testing to demonstrate correct function and monitoring operating status. The test interval shall be consistent with the basis of the SIL analysis.

A.9.3.7.2. Following are the minimum considerations that shall be verified during in place test of a HIPPS valve:

- a) Regular Pressure/Leak Integrity Testing: The HIPPS shall be capable of demonstrating that the system has sufficient integrity to contain SIP with leakage less than the maximum leak rate. Testing interval will be determined by SIL rating or regulatory requirement.

- b) **Maximum Leak Rate Testing:** The HIPPS design shall include appropriate methods to measure or infer the leak rate of the HIPPS for comparison to the predetermined maximum leak rate. Maximum leak rate determination shall consider both short-term shutdown events and long-term shutdown events such as a storm shut-in and shall either be set by the operator or by regulatory requirement.
- c) **Partial Stroke Testing (PST):** Each valve shall be supplied with a dedicated Partial Stroke Test (PST) system installed inside the local control valve cabinet. Required Partial Stroke Test shall be implemented using devices specifically designed and certified for that purpose. PST shall be considered as a functional test which covers only a fraction of the possible failures, and not as self-test with diagnostic coverage. The fraction detected shall be properly documented. As minimum, the following tests shall be scope of the PST:
  - 4 actuations of HIPPS valves under operational condition, with nominal line pressure in upstream, downstream and body cavity;
  - 4 actuations of HIPPS valves under DBB condition, direction open to close. In this case the valve should be at opened position, with nominal line pressure in the bore and without pressure in the cavity;
  - 4 actuations of HIPPS valves under DBB condition, direction close to open. In this case the valve should be at closed position, with nominal line pressure in upstream and downstream, and without pressure in the cavity;
  - For the FAT tests of the valve HIPPS, the sequence described herein shall be done considering the line pressure of 0% PMT, 50% PMT and 100% PMT.

NOTE: The results of the PST shall be registered using a statistical analysis (i.e.: average, standard deviation), in order to serve as a reference for the commissioning test and periodical test. Also, a failure mode effects and criticality analysis (e.g.: FMECA) shall be considered to be used.

## **A.10. HANDLING, STORING & SHIPPING**

A.10.1. The manufacturer shall present a tested/validated procedure by laboratory performance for the preservation system and a procedure with handling, storing, packaging and shipping the valve (including actuator and positioner - electric/electronic parts).

A.10.2. After hydrostatic test, all valves shall be purged with dry compressed air, in the fully open position, until they are completely dry.

A.10.3. After purge, the valve shall be kept closed or opened, according to manufacturer instruction, inner protected with VCI for all the parts and no corrosion protector that will need any solvent to be removed may be used.

A.10.4. Valves with corrosion resistant materials needs the corrosion inhibitor for liquid and vapor phase added on the water, but do not need the use of VCI. Corrosion protector that will need any solvent to be removed shall not be used.

A.10.5. Valves made of brass, stainless steel and other non-oxidizable metal alloys shall receive protection against dust and moisture.

A.10.6. Small sized valves may be shipped inside a collective package. Even that, each valve shall be individually package prior to assembly the collective package.

A.10.7. Medium valves shall have an individual package.

A.10.8. Large valves shall be packed limited to their nozzles considering that they are protected by the painting.

A.10.9. The valves may be packed on upright or horizontal position, on open or closed position, according to manufacturer recommendation.

## A.11. DOCUMENTATION

### A.11.1. DOCUMENTATION FORMATS & QUALITY

- A.11.1.1. Whenever is possible (e.g.: a supply from a Brazilian manufacturer) all documentation shall be delivered in Portuguese (pt-BR). An alternative language to be considered for the documentation shall be English (e.g.: supply from an international manufacturer). Any deviation shall be requested and approved by PETROBRAS in advance of the delivery.
- A.11.1.2. Typically, the format for the documents shall be Adobe Acrobat PDF (\*.PDF). Other formats shall be agreed with PETROBRAS.
- A.11.1.3. All documentation shall be of good quality with maximum legibility. Scanned images shall be checked before submittal for proper image quality, skewness and completeness.

### A.11.2. DATA BOOK

- A.11.2.1. The Data Book shall be filled in a manner which will facilitate rapid retrieval of information. They shall be made available to PETROBRAS, if required, for at least 5 years following the commencement of the guarantee period of last batch commercialized.
- A.11.2.2. The Data Book shall represent the manufacturer's compilation of calculations together with the necessary drawings, manufacturing, testing and inspection procedures, certificates, personnel qualifications, non-conformance reports, records and reports required to demonstrate that the valve and actuator is in compliance with PETROBRAS's requirements.
- A.11.2.3. It shall include, as minimum:
- a) Material certificates of compliance;
  - b) ITP copy approved by PETROBRAS or EPC purchaser;
  - c) Copy of all reports issued by the company responsible for inspection;
  - d) WPS and WPQR for structural welding;
  - e) Repair weld maps;
  - f) NDT reports with lists of welder and NDT operator qualifications and procedures, and drawings of critical areas for NDT;
  - g) Relevant fabrication drawings;
  - h) Reports of non-compliance and corrective actions taken;
  - i) FAT procedure and test results.
  - j) Actuator certificate;
  - k) Positioner certificate;
  - l) Fire-test certificate, when applicable;
  - m) Fugitive emission certificate, when applicable;

n) Inspection final report for shipment.

A.11.2.4. The issue of certificates shall be according EN 10204 type 2.2 for parts with no risk for environment as: hard welding deposit, closures, seal, springs and so on.

A.11.2.5. The issue of certificates shall be according EN 10204 type 3.1 for parts with risk for environment as: body, bonnet, cover, stem, studs/bolts, etc.

A.11.2.6. The Data Book shall be issued one per valve or one per purchase order (with traceability for valves groups). One hard copy of the Data Book shall be sent with the valve to final destination and an electronic copy shall be sent to the PURCHASER.

A.11.2.7. All material certificates shall be identified with: valve serial number, project name (when applicable), purchase order number, order item number, VDS number or project number.

### **A.11.3. USER MANUAL**

A.11.3.1. The User Manual shall in an organized manner, give sufficient information in order to enable operation and maintenance of the valve in a safe, economical and functionally correct manner during all phases after installation.

A.11.3.2. The User Manual shall cover valve and actuator.

A.11.3.3. All documents shall be updated to "as-built".

### **A.11.4. DOCUMENTATION OF PRESERVATION, PROTECTION AND PACKING**

A.11.4.1. The manufacturer shall prepare and submit procedure(s) for PETROBRAS approval, showing the following:

- a) description of the initial preservation/protection/packing carried out by the manufacturer prior to shipment:
  - The procedure shall also specify type of preservatives/ lubricants used, with technical data, handling and safety instructions, especially giving details of any chemical substances used that may be hazardous to personnel or environment.
- b) description of re-preservation after incoming inspection at end destination:
  - Preservation maintenance is to be carried out by the user during storage, installation and in the period prior to start-up for the intended use.
- c) unpacking and removal of protective devices and preservatives prior to operation:
  - The procedure shall indicate the proposed lifting methods for the valve and actuator, and all additional measures that shall be observed prior to and during installation.

A.11.4.2. The documentation of preservation, protection and packing shall fulfill all requirements stated on item A.10.

**A.11.5. VALVE CODE**

**A.11.5.1. DESCRIPTION**

A.11.5.1.1. All valves specified for application in Exploration and Production (E&P) oil production and process facilities have a unique code, in order to have uniformity and to systematize the coding of valves so that they can be handled in an organized manner and information can be easily retrieved.

A.11.5.1.2. The complete structure of all valve codes shall be as follows (some exemptions may occur):

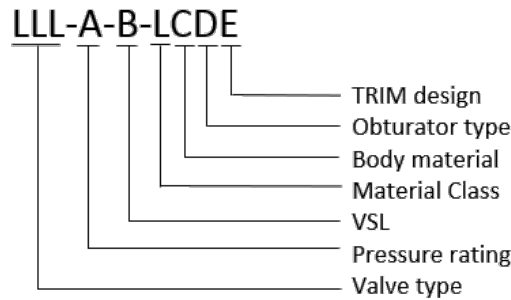

**A.11.5.2. BASIC STRUCTURE OF A VALVE CODE**

A.11.5.2.1. The valve code shall be made up of 3 basic groups ordered as follows:

<b>Group 0</b>	<b>Group 1</b>	<b>Group 2</b>
Valve Type	Pressure Rating	VSL
LLL	- A	- B

Where:

L is a letter;

A, B are numbers.

**A.11.5.3. CONCEPT OF BASIC GROUPS**

**A.11.5.3.1. IDENTIFICATION OF VALVE TYPE (GROUP 0)**

A.11.5.3.1.1. This is the basic group that identifies the type of the valve.

A.11.5.3.1.2. This group is comprised of three letters and its configuration is illustrated as follows:

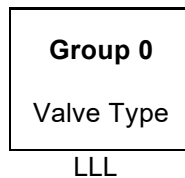

A.11.5.3.1.3. The following characters shall be used to distinguish the type of the valve:

- VAG – Needle valve
- VAX – Axial valve
- VBO – Butterfly valve
- VDE – Double Ball valve



VDI – Diaphragm valve

VES – Ball valve

VGA – Gate valve

VGL – Globe valve

VMA – Plug valve

VRE – Check valve

A.11.5.3.2. IDENTIFICATION OF PRESSURE RATING (GROUP 1)

A.11.5.3.2.1. This is the basic group that identifies the pressure rating of the valve.

A.11.5.3.2.2. This group is comprised at least of three and maximum of 5 numbers and its configuration is illustrated as follows:

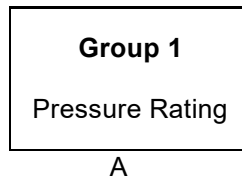

A.11.5.3.2.3. The following characters shall be used to distinguish the pressure rating of the valve:

125 – ASME Class 125

150 – ASME Class 150

250 – Maximum pressure 250 psi (for Category A butterfly valves only)

300 – ASME Class 300

600 – ASME Class 600

800 - ASME Class 800

801 – ASME Class 800 with SCH 40S (for ball valves)

801 – ASME Class 800 with SW ends ASME B16.11 (for gate valves)

802 – ASME Class 800 with SCH 80

803 – ASME Class 800 with SCH 160

804 – ASME Class 800 with SCH XXS

900 – ASME Class 900

1500 – ASME Class 1500

1501 – ASME Class 1500 with SCH 40S (for ball vales)

1501 – ASME Class 1500 with SW ends ASME B16.11 (for gate valves)

1502 – ASME Class 1500 with SCH 80

1503 – ASME Class 1500 with SCH 160

1504 – ASME Class 1500 with SCH XXS

2500 – ASME Class 2500, with ASME flanges

- 2501 – ASME Class 2500 with SCH 40S (for ball valves)
- 2501 – ASME Class 2500 with SW ends ASME B16.11 (for gate valves)
- 2502 – ASME Class 2500 with SCH 80
- 2503 – ASME Class 2500 with SCH 160
- 2504 – ASME Class 2500 with SCH XXS
- 2510 – ASME Class 2500, with compact flanges
- 2510R - ASME Class 2500, with compact flanges and reduced bore
- 3000 – Maximum Pressure 3.000 psi
- 5000 – Maximum Pressure 5.000 psi
- 6000 – Maximum Pressure 6.000 psi
- 10000 – Maximum Pressure 10.000 psi

**A.11.5.3.3. IDENTIFICATION OF VSL (GROUP 2)**

- A.11.5.3.3.1. This is the basic group that identifies the VSL of the valve.
- A.11.5.3.3.2. This group is comprised with one number and its configuration is illustrated as follows:

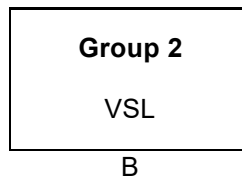

- A.11.5.3.3.3. The following characters shall be used to distinguish the VSL of the valve:

- 1 – VSL-1
- 2 – VSL-2
- 3 – VSL-3
- 4 – VSL-4

**A.11.5.4. SPECIFIC STRUCTURE OF A VALVE CODE**

- A.11.5.4.1. The valve code shall be made up of 4 specific groups ordered as follows:

<b>Group 3</b>	<b>Group 4</b>	<b>Group 5</b>	<b>Group 6</b>
Material Class	Body material	Obturator type	TRIM design
L	- C	- D	- E

Where:

L is a letter;

C, D, E may be either numbers or letters.

### A.11.5.5. CONCECPT OF SPECIFIC GROUPS

#### A.11.5.5.1. IDENTIFICATION OF MATERIAL CLASS (GROUP 3)

A.11.5.5.1.1. This is the basic group that identifies the material class of the valve.

A.11.5.5.1.2. This group is comprised of one letter and its configuration is illustrated as follows:

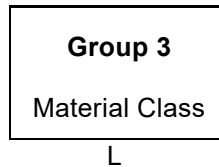

A.11.5.5.1.3. The following characters shall be used to distinguish the material class of the valve:

C – Carbon steel

A – Alloy Steel

S – Stainless steel

D – Duplex steel

N – Nickel alloy 625

U – Uncommon materials

H -

#### A.11.5.5.2. IDENTIFICATION OF BODY MATERIAL (GROUP 4)

A.11.5.5.2.1. This is the basic group that identifies the body material of the valve.

A.11.5.5.2.2. This group is comprised of one number and its configuration is illustrated as follows:

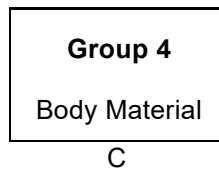

A.11.5.5.2.3. The following characters shall be used to distinguish the body material of the valve, related to the specific material class of the valve:

Table A.64 – Identification of body material code, according to respective material class

Body Material	Material Class					
	C	A	S	D	N	U
	Carbon steel	Alloy steel	Stainless steel	Duplex steel	Nickel alloys	Uncommon materials
<b>1</b>	ASTM A105 or ASTM A216 WCB	ASTM A350 LF3 or ASTM 352 LC3	-	ASTM A995 Gr. 1B	Alloy 625 (UNS N06625)	Bronze
<b>2</b>	A350 LF2 CL1 or ASTM A352 LCC	ASTM A182 F5	ASTM A182 Gr. F316 or ASTM A351 Gr. CF8M	ASTM A182 Gr. F51 or ASTM A995 Gr. 4A	Alloy C-276 (UNS N30002)	ASTM A536-65-45-12
<b>3</b>	ASTM A105 or ASTM A216 WCB + Organic Coating (Onshore use only)	ASTM A182 F11 CL2	ASTM A182 Gr. F317 or ASTM A351 Gr. CG8M	ASTM A182 Gr. F55 or ASTM A995 Gr 6A	Alloy C-276 (UNS N10276)	ASTM B148 (UNS C95800)
<b>4</b>	ASTM A105 or ASTM A216 WCB + Organic Coating (Offshore)	ASTM A522 Type I	ASTM A182 Gr. F347 or ASTM A351 Gr. CF8C	-	-	Plastics
<b>5</b>	ASTM A105 or ASTM A216 WCB + alloy 625 overlay (UNS N06625)	ASTM A350 LF3 or ASTM A352 LC3 + alloy 625 overlay (UNS N06625)	-	-	-	Gray Iron
<b>6</b>	ASTM A350 LF2 CL1 or ASTM A352 LCC + alloy 625 overlay (UNS N06625)	ASTM A522 Type I + alloy 625 overlay (UNS N06625)	-	-	-	-

A.11.5.5.3. IDENTIFICATION OF OBTURATOR TYPE (GROUP 5)

A.11.5.5.3.1. This is the basic group that identifies the obturator type of the valve.

A.11.5.5.3.2. This group is comprised of one number and its configuration is illustrated as follows:

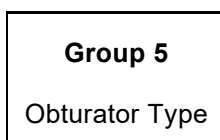

D

A.11.5.5.3.3. The following characters shall be used to distinguish the obturator type of the valve:

Table A.65 – Identification of obturator type, according to valve type

Obturator type	Valve Type			
	Gate valve	Globe valve	Check Valve	Butterfly valve
0	Solid wedge	Bevelled disc	Piston	See Table A.51
1	Slab gate	Angular	Dual Plate	
2	Expanding	-	Swing	
3	Flexible wedge	-	Axial non-slam	
4	-	-	Ball	
5	-	-	Swing, spring loaded, non-slam	
6	-	-	Manufacturer standard	
F	-	Bevelled disc, with fugitive emission	-	

NOTE: For ball and double ball valves, the last two digits “D” (GROUP 5) and “E” (GROUP 6) in the valve code presents the configuration number of the valve, where:

DE – presents the basic configuration, according Table A.25 – for metallic ball valves up to NPS 1 1/2 (“Forged” valves);

DE – presents the basic configuration, according Table A.28 – for metallic double ball valves up to NPS 2 (“Forged” valves);

DE – presents the basic configuration, according Table A.53 – for non-metallic valves;

D - presents the selected group seal, according Table A.23 – for ball valves with NPS 2 and above and for double ball valves with NPS 3 and above.

A.11.5.5.4. IDENTIFICATION OF TRIM DESIGN (GROUP 6)

A.11.5.5.4.1. This is the basic group that identifies the TRIM design of the valve.

A.11.5.5.4.2. This group is comprised of one number and its configuration is illustrated as follows:

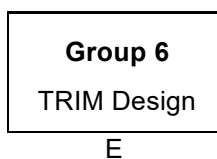

A.11.5.5.4.3. The following characters shall be used to distinguish the TRIM design of the valve:

Table A.66 – Identification of TRIM design, according to valve type

TRIM design	Valve Type	
	Gate Globe	Check
1	Standard TRIM	Soft TRIM
2	Alternative TRIM	Metal to Metal TRIM
3	N/A	Alternative Metal to Metal TRIM

Valve Type		
Butterfly (see Table A.52)		
Face type	Lug	Double Flanged (Short Pattern)
RF	1	3
FF	4	6
RTJ	7	9

NOTE: For ball valves, the last two digits “D” and “E” in the valve code presents the configuration number of the valve, where:

DE – presents the basic configuration, according Table A.25 – for metallic ball valves up to NPS 1 1/2 (“Forged” valves).

DE – presents the basic configuration, according Table A.28 – for metallic double ball valves up to NPS 2 (“Forged” valves);

DE – presents the basic configuration, according Table A.53 – for non-metallic valves;

E - presents the basic configuration, according Table A.26 – for ball valves with NPS 2 and above and for double ball valves with NPS 3 and above.

#### A.11.5.5.5. EXAMPLE OF VALVE CODE

##### A.11.5.5.5.1. Example 1

Gate valve, pressure rating class 900, VSL-2, material class of carbon steel, solid wedge, using standard TRIM:

#### **VGA-900-2-C101**

Valve Type: VGA – Gate valve

Pressure Rating: 900 – Class 900

VSL: 2 – VSL-2

Material Class: C – Carbon steel

Body Material: 1 – ASTM A105 or ASTM A216 WCB

Obturator type: 0 – Solid wedge

Trim design: 1 – Standard TRIM

##### A.11.5.5.5.2. Example 2

Ball valve, pressure rating 1500, VSL-2, material class of carbon steel, configuration 04 with nipple SCH XXS:

#### **VES-1504-2-C207**

Valve Type: VES – Ball valve

Pressure Rating: 1504 – ASME Class 1500 with SCH XXS

VSL: 2 – VSL-2

Material Class: C – Carbon steel

Body Material: 2 – A350 LF2 CL1 or ASTM A352 LCC

Configuration: 07 – Metal-to-metal ball valve with configuration according Table A.25

A.11.5.5.5.3. Example 3

Ball valve, pressure rating 2500, VSL-3, material class of super duplex, soft sealing, fire tested, DIB-2:

**VES-2500-3-D339**

Valve Type: VES – Ball valve

Pressure Rating: 2500 – ASME Class 2500

VSL: 3 – VSL-3

Material Class: D – Super duplex

Body Material: 3 – ASTM 182 Gr. F55

Seal Group: 3 – Groups D or E

Configuration: 9 – Soft sealing ball valve with configuration according Table A.26.

**VRE-800-1-C10D**

Valve Type: VRE – Check valve

Pressure Rating: 800 – ASME Class 800

VSL: 1 – VSL-1

Material Class: C – Carbon steel

Body Material: 1 – ASTM A105 or ASTM A216 WCB

Obturator type: 0 – Piston according Table A.43

A – Wafer; B – lug; C – Flange; D – Screwed; E – socket; F – OD; G – butt weld; H - studded

## **A.12. VALVE DATASHEET - VDS**

































































Valve Code	VES-150-2-S282
Specs	B3
1. Valve Type	Ball
2. Sealing Type	Metal to Metal
3. Valve Specification Level (VSL)	VSL-2
4. Ball Mouting	Trunnion
5. Standard	API 6D
6. Size Range (NPS)	2" - 36"
7. End Connection	RF
8. Pressure Class	150
9. Temperature	-100°C to 400°C
10. Material Class	Stainless Steel
11. Body Material	ASTM A182 Gr F316 or ASTM A351 Gr CF8M
12. Obturator Material	AISI 316 + Chrome-Nickel Spray and Fuse (acc. Item A.8.2.2.4)
13. Seat Material	AISI 316 + Chrome-Nickel Spray and Fuse (acc. Item A.8.2.2.4)
14. Seat Insert	N/A
15. Spring (Seat) Material	UNS N07718
16. Stem Material	ASTM A276 (UNS S31600)
17. Seat-Stem Seal	Group F (acc. item A.7.1.5.6)
18. Operator Type	2" - 4" Lever 6" - 36" Gearbox
19. Additional Requirement	N/A
20. Seat Type	(For trunnion-mounted) Side A: SPE / Side B: DPE; DIB-2 & DBB
21. Bore Type	Full Bore
22. Body Construction	split body, bolted
23. Cladding or Coating	N/A
24. Valve Testing	FAT according A.9.3
25. Notes	N/A

Valve Code	VES-150-2-S28G
Specs	B3
1. Valve Type	Ball
2. Sealing Type	Metal to Metal
3. Valve Specification Level (VSL)	VSL-2
4. Ball Mouting	2" - 4" Floating 6" - 36" Trunnion
5. Standard	API 6D
6. Size Range (NPS)	2" - 36"
7. End Connection	RF
8. Pressure Class	150
9. Temperature	-100°C to 400°C
10. Material Class	Stainless Steel
11. Body Material	ASTM A182 Gr F316 or ASTM A351 Gr CF8M
12. Obturator Material	AISI 316 + Chrome-Nickel Spray and Fuse (acc. Item A.8.2.2.4)
13. Seat Material	AISI 316 + Chrome-Nickel Spray and Fuse (acc. Item A.8.2.2.4)
14. Seat Insert	N/A
15. Spring (Seat) Material	UNS N07718
16. Stem Material	ASTM A276 (UNS S31600)
17. Seat-Stem Seal	Group F (acc. item A.7.1.5.6)
18. Operator Type	2" - 4" Lever 6" - 36" Gearbox
19. Additional Requirement	Fire Tested (acc. item A.6.1.4); Fugitive Emission (acc. item A.6.1.6)
20. Seat Type	(For trunnion-mounted) Side A: SPE / Side B: DPE; DIB-2 & DBB
21. Bore Type	Full Bore
22. Body Construction	split body, bolted
23. Cladding or Coating	N/A
24. Valve Testing	FAT according A.9.3
25. Notes	N/A

Valve Code	VES-150-2-U300
Specs	B7 B14 B23
1. Valve Type	Ball
2. Sealing Type	Soft
3. Valve Specification Level (VSL)	VSL-2
4. Ball Mouting	Floating
5. Standard	API 6D
6. Size Range (NPS)	1" - 1 1/2"
7. End Connection	Flange ASME B16.5, RF
8. Pressure Class	150
9. Temperature	0°C to 90°C
10. Material Class	Uncommon Materials
11. Body Material	ASTM B148 (UNS C95800)
12. Obturator Material	ASTM B148 (UNS C95800)
13. Seat Material	PTFE reinforced with 25% Carbon
14. Seat Insert	N/A
15. Spring (Seat) Material	N/A
16. Stem Material	Monel K500
17. Seat-Stem Seal	Group B (acc. item A.7.1.5.6)
18. Operator Type	Lever
19. Additional Requirement	Fire Tested (acc. item A.6.1.4)
20. Seat Type	N/A
21. Bore Type	Full Bore
22. Body Construction	split body, bolted
23. Cladding or Coating	N/A
24. Valve Testing	FAT according A.9.3
25. Notes	N/A

Valve Code	VES-150-2-U310
Specs	B14 B22 B23
1. Valve Type	Ball
2. Sealing Type	Soft
3. Valve Specification Level (VSL)	VSL-2
4. Ball Mouting	2" - 4" Floating 6" - 24" Trunnion
5. Standard	API 6D
6. Size Range (NPS)	2" - 24"
7. End Connection	RF
8. Pressure Class	150
9. Temperature	0°C to 90°C
10. Material Class	Uncommon Materials
11. Body Material	ASTM B148 (UNS C95800)
12. Obturator Material	ASTM B148 (UNS C95800)
13. Seat Material	ASTM B148 (UNS C95800)
14. Seat Insert	PTFE reinforced with 25% Carbon
15. Spring (Seat) Material	UNS N05500
16. Stem Material	Monel K500
17. Seat-Stem Seal	Group B (acc. item A.7.1.5.6)
18. Operator Type	2" - 4" Lever 6" - 24" Gearbox
19. Additional Requirement	N/A
20. Seat Type	N/A
21. Bore Type	Full Bore
22. Body Construction	split body, bolted
23. Cladding or Coating	N/A
24. Valve Testing	FAT according A.9.3
25. Notes	N/A

Valve Code	VES-150-2-U311
Specs	B7
1. Valve Type	Ball
2. Sealing Type	Soft
3. Valve Specification Level (VSL)	VSL-2
4. Ball Mouting	2" - 4" Floating 6" - 24" Trunnion
5. Standard	API 6D
6. Size Range (NPS)	2" - 24"
7. End Connection	RF
8. Pressure Class	150
9. Temperature	0°C to 90°C
10. Material Class	Uncommon Materials
11. Body Material	ASTM B148 (UNS C95800)
12. Obturator Material	ASTM B148 (UNS C95800)
13. Seat Material	ASTM B148 (UNS C95800)
14. Seat Insert	PTFE reinforced with 25% Carbon
15. Spring (Seat) Material	UNS N05500
16. Stem Material	Monel K500
17. Seat-Stem Seal	Group B (acc. item A.7.1.5.6)
18. Operator Type	2" - 4" Lever 6" - 24" Gearbox
19. Additional Requirement	Fire Tested (acc. item A.6.1.4)
20. Seat Type	N/A
21. Bore Type	Full Bore
22. Body Construction	split body, bolted
23. Cladding or Coating	N/A
24. Valve Testing	FAT according A.9.3
25. Notes	N/A

Valve Code	VES-150-2-U600
Specs	B14 B27
1. Valve Type	Ball
2. Sealing Type	Soft
3. Valve Specification Level (VSL)	VSL-2
4. Ball Mouting	Floating
5. Standard	Manufacturer standard
6. Size Range (NPS)	1" - 6"
7. End Connection	ASME B16.1, FF
8. Pressure Class	150
9. Temperature	0°C to 70°C
10. Material Class	Uncommon Materials
11. Body Material	ASTM A395 60-40-18 + PFA liner
12. Obturator Material	Stainless Steel + PFA liner
13. Seat Material	PTFE
14. Seat Insert	N/A
15. Spring (Seat) Material	N/A
16. Stem Material	According manufacturer standard, fitted to service conditions
17. Seat-Stem Seal	According to manufacturer standard, fitted to service conditions
18. Operator Type	Lever
19. Additional Requirement	N/A
20. Seat Type	N/A
21. Bore Type	Full Bore
22. Body Construction	split body, bolted
23. Cladding or Coating	N/A
24. Valve Testing	FAT according manufacturer standard
25. Notes	N/A

Valve Code	VES-1503-1-C106
Specs	G10
1. Valve Type	Ball
2. Sealing Type	Soft
3. Valve Specification Level (VSL)	VSL-1
4. Ball Mouting	Trunnion
5. Standard	ASME B16.34 LTD
6. Size Range (NPS)	1/2" - 1 1/2"
7. End Connection	socket weld ends ASME B16.11 with nipple SCH 160
8. Pressure Class	1500
9. Temperature	0°C to 150°C
10. Material Class	Carbon Steel
11. Body Material	ASTM A105
12. Obturator Material	AISI 410
13. Seat Material	AISI 410
14. Seat Insert	PEEK
15. Spring (Seat) Material	UNS N07750
16. Stem Material	ASTM A276 (UNS S41000)
17. Seat-Stem Seal	Group A (acc. item A.7.1.5.6)
18. Operator Type	Lever
19. Additional Requirement	Fire Tested (acc. item A.6.1.4)
20. Seat Type	(For trunnion-mounted) Side A: SPE / Side B: SPE
21. Bore Type	Full Bore
22. Body Construction	split body, bolted
23. Cladding or Coating	N/A
24. Valve Testing	FAT according A.9.3
25. Notes	N/A

Valve Code	VES-1503-1-C107
Specs	G10
1. Valve Type	Ball
2. Sealing Type	Metal to Metal
3. Valve Specification Level (VSL)	VSL-1
4. Ball Mouting	Trunnion
5. Standard	ASME B16.34 LTD
6. Size Range (NPS)	1/2" - 1 1/2"
7. End Connection	socket weld ends ASME B16.11 with nipple SCH 160
8. Pressure Class	1500
9. Temperature	-29°C to 210°C
10. Material Class	Carbon Steel
11. Body Material	ASTM A105
12. Obturator Material	AISI 410 + Hard Coating (acc. Item A.7.1.7.4)
13. Seat Material	AISI 410 + Hard Coating (acc. Item A.7.1.7.4)
14. Seat Insert	N/A
15. Spring (Seat) Material	UNS N07750
16. Stem Material	ASTM A276 (UNS S41000)
17. Seat-Stem Seal	Group D (acc. item A.7.1.5.6)
18. Operator Type	Lever
19. Additional Requirement	Fire Tested (acc. item A.6.1.4)
20. Seat Type	(For trunnion-mounted) Side A: SPE / Side B: SPE
21. Bore Type	Full Bore
22. Body Construction	split body, bolted
23. Cladding or Coating	N/A
24. Valve Testing	FAT according A.9.3
25. Notes	N/A

Valve Code	VES-1503-1-C206
Specs	F6
1. Valve Type	Ball
2. Sealing Type	Soft
3. Valve Specification Level (VSL)	VSL-1
4. Ball Mouting	Trunnion
5. Standard	ASME B16.34 LTD
6. Size Range (NPS)	1/2" - 1 1/2"
7. End Connection	socket weld ends ASME B16.11 with nipple SCH 160
8. Pressure Class	1500
9. Temperature	-30°C to 150°C
10. Material Class	Low-Temperature Carbon Steel
11. Body Material	ASTM A350 Gr LF2 CL1
12. Obturator Material	AISI 316
13. Seat Material	AISI 316
14. Seat Insert	PEEK
15. Spring (Seat) Material	UNS N07750
16. Stem Material	ASTM A276 (UNS S31803)
17. Seat-Stem Seal	Group B (acc. item A.7.1.5.6)
18. Operator Type	Lever
19. Additional Requirement	Fire Tested (acc. item A.6.1.4)
20. Seat Type	(For trunnion-mounted) Side A: SPE / Side B: SPE
21. Bore Type	Full Bore
22. Body Construction	split body, bolted
23. Cladding or Coating	N/A
24. Valve Testing	FAT according A.9.3
25. Notes	N/A

Valve Code	VES-1503-1-C207
Specs	F6
1. Valve Type	Ball
2. Sealing Type	Metal to Metal
3. Valve Specification Level (VSL)	VSL-1
4. Ball Mouting	Trunnion
5. Standard	ASME B16.34 LTD
6. Size Range (NPS)	1/2" - 1 1/2"
7. End Connection	socket weld ends ASME B16.11 with nipple SCH 160
8. Pressure Class	1500
9. Temperature	-46°C to 200°C
10. Material Class	Low-Temperature Carbon Steel
11. Body Material	ASTM A350 Gr LF2 CL1
12. Obturator Material	AISI 316 + Hard Coating (acc. Item A.7.1.7.4)
13. Seat Material	AISI 316 + Hard Coating (acc. Item A.7.1.7.4)
14. Seat Insert	N/A
15. Spring (Seat) Material	UNS N07750
16. Stem Material	ASTM A276 (UNS S31803)
17. Seat-Stem Seal	Group E (acc. item A.7.1.5.6)
18. Operator Type	Lever
19. Additional Requirement	Fire Tested (acc. item A.6.1.4)
20. Seat Type	(For trunnion-mounted) Side A: SPE / Side B: SPE
21. Bore Type	Full Bore
22. Body Construction	split body, bolted
23. Cladding or Coating	N/A
24. Valve Testing	FAT according A.9.3
25. Notes	N/A

Valve Code	VES-1503-2-C106
Specs	G10
1. Valve Type	Ball
2. Sealing Type	Soft
3. Valve Specification Level (VSL)	VSL-2
4. Ball Mouting	Trunnion
5. Standard	ASME B16.34 LTD
6. Size Range (NPS)	1/2" - 1 1/2"
7. End Connection	socket weld ends ASME B16.11 with nipple SCH 160
8. Pressure Class	1500
9. Temperature	0°C to 150°C
10. Material Class	Carbon Steel
11. Body Material	ASTM A105
12. Obturator Material	AISI 410
13. Seat Material	AISI 410
14. Seat Insert	PEEK
15. Spring (Seat) Material	UNS N07750
16. Stem Material	ASTM A276 (UNS S41000)
17. Seat-Stem Seal	Group A (acc. item A.7.1.5.6)
18. Operator Type	Lever
19. Additional Requirement	Fire Tested (acc. item A.6.1.4)
20. Seat Type	(For trunnion-mounted) Side A: SPE / Side B: SPE
21. Bore Type	Full Bore
22. Body Construction	split body, bolted
23. Cladding or Coating	N/A
24. Valve Testing	FAT according A.9.3
25. Notes	N/A

Valve Code	VES-1503-2-C107
Specs	G10
1. Valve Type	Ball
2. Sealing Type	Metal to Metal
3. Valve Specification Level (VSL)	VSL-2
4. Ball Mouting	Trunnion
5. Standard	ASME B16.34 LTD
6. Size Range (NPS)	1/2" - 1 1/2"
7. End Connection	socket weld ends ASME B16.11 with nipple SCH 160
8. Pressure Class	1500
9. Temperature	-29°C to 210°C
10. Material Class	Carbon Steel
11. Body Material	ASTM A105
12. Obturator Material	AISI 410 + Hard Coating (acc. Item A.7.1.7.4)
13. Seat Material	AISI 410 + Hard Coating (acc. Item A.7.1.7.4)
14. Seat Insert	N/A
15. Spring (Seat) Material	UNS N07750
16. Stem Material	ASTM A276 (UNS S41000)
17. Seat-Stem Seal	Group D (acc. item A.7.1.5.6)
18. Operator Type	Lever
19. Additional Requirement	Fire Tested (acc. item A.6.1.4)
20. Seat Type	(For trunnion-mounted) Side A: SPE / Side B: SPE
21. Bore Type	Full Bore
22. Body Construction	split body, bolted
23. Cladding or Coating	N/A
24. Valve Testing	FAT according A.9.3
25. Notes	N/A











Valve Code	VES-150-3-C252	
Specs	B6	
1. Valve Type	Ball	
2. Sealing Type	Metal to Metal	
3. Valve Specification Level (VSL)	VSL-3	
4. Ball Mouting	2" - 4" Floating	6" - 36" Trunnion
5. Standard	API 6D / IOGP S-562	
6. Size Range (NPS)	2" - 36"	
7. End Connection	RF	
8. Pressure Class	150	
9. Temperature	-30°C to 150°C	
10. Material Class	Low-Temperature Carbon Steel	
11. Body Material	ASTM A350 Gr LF2 CL1 + Inconel 625 weld overlay (acc. item A.7.1.7.3)	
12. Obturator Material	AISI 316 + Tungsten carbide coating	
13. Seat Material	AISI 316 + Tungsten carbide coating	
14. Seat Insert	N/A	
15. Spring (Seat) Material	UNS N07750	
16. Stem Material	ASTM A276 (UNS S31600)	
17. Seat-Stem Seal	Group B (acc. item A.7.1.5.6)	
18. Operator Type	2" - 4" Lever	6" - 36" Gearbox
19. Additional Requirement	N/A	
20. Seat Type	(For trunnion-mounted) Side A: SPE / Side B: DPE; DIB-2 & DBB	
21. Bore Type	Full Bore	
22. Body Construction	split body, bolted	
23. Cladding or Coating	Partial clad - Inconel 625 weld overlay on all body sealing areas	
24. Valve Testing	FAT according A.9.3	
25. Notes	Acceptance criteria for sealing tests see Annex A	

Valve Code	VES-150-3-C253	
Specs	B6	
1. Valve Type	Ball	
2. Sealing Type	Metal to Metal	
3. Valve Specification Level (VSL)	VSL-3	
4. Ball Mouting	2" - 4" Floating	6" - 36" Trunnion
5. Standard	API 6D / IOGP S-562	
6. Size Range (NPS)	2" - 36"	
7. End Connection	RF	
8. Pressure Class	150	
9. Temperature	-30°C to 150°C	
10. Material Class	Low-Temperature Carbon Steel	
11. Body Material	ASTM A350 Gr LF2 CL1 + Inconel 625 weld overlay (acc. item A.7.1.7.3)	
12. Obturator Material	AISI 316 + Tungsten carbide coating	
13. Seat Material	AISI 316 + Tungsten carbide coating	
14. Seat Insert	N/A	
15. Spring (Seat) Material	UNS N07750	
16. Stem Material	ASTM A276 (UNS S31600)	
17. Seat-Stem Seal	Group B (acc. item A.7.1.5.6)	
18. Operator Type	2" - 4" Lever	6" - 36" Gearbox
19. Additional Requirement	Fire Tested (acc. item A.6.1.4)	
20. Seat Type	(For trunnion-mounted) Side A: SPE / Side B: DPE; DIB-2 & DBB	
21. Bore Type	Full Bore	
22. Body Construction	split body, bolted	
23. Cladding or Coating	Partial clad - Inconel 625 weld overlay on all body sealing areas	
24. Valve Testing	FAT according A.9.3	
25. Notes	Acceptance criteria for sealing tests see Annex A	

Valve Code	VES-150-3-C256	
Specs	B6	
1. Valve Type	Ball	
2. Sealing Type	Metal to Metal	
3. Valve Specification Level (VSL)	VSL-3	
4. Ball Mouting	2" - 4" Floating	6" - 36" Trunnion
5. Standard	API 6D / IOGP S-562	
6. Size Range (NPS)	2" - 36"	
7. End Connection	RF	
8. Pressure Class	150	
9. Temperature	-29°C to 150°C	
10. Material Class	Low-Temperature Carbon Steel	
11. Body Material	ASTM A350 Gr LF2 CL1 + Inconel 625 weld overlay (acc. item A.7.1.7.3)	
12. Obturator Material	AISI 316 + Tungsten carbide coating	
13. Seat Material	AISI 316 + Tungsten carbide coating	
14. Seat Insert	N/A	
15. Spring (Seat) Material	UNS N07750	
16. Stem Material	ASTM A276 (UNS S31600)	
17. Seat-Stem Seal	Group B (acc. item A.7.1.5.6)	
18. Operator Type	2" - 4" Lever	6" - 36" Gearbox
19. Additional Requirement	Fire Tested (acc. item A.6.1.4); Fugitive Emission (acc. item A.6.1.6)	
20. Seat Type	(For trunnion-mounted) Side A: SPE / Side B: DPE; DIB-2 & DBB	
21. Bore Type	Full Bore	
22. Body Construction	split body, bolted	
23. Cladding or Coating	Partial clad - Inconel 625 weld overlay on all body sealing areas	
24. Valve Testing	FAT according A.9.3	
25. Notes	Acceptance criteria for sealing tests see Annex A	

Valve Code	VES-150-3-C272	
Specs	B6	
1. Valve Type	Ball	
2. Sealing Type	Metal to Metal	
3. Valve Specification Level (VSL)	VSL-3	
4. Ball Mouting	2" - 4" Floating	6" - 36" Trunnion
5. Standard	API 6D	
6. Size Range (NPS)	2" - 36"	
7. End Connection	RF	
8. Pressure Class	150	
9. Temperature	-46°C to 200°C	
10. Material Class	Low-Temperature Carbon Steel	
11. Body Material	ASTM A350 Gr LF2 CL1 + Inconel 625 weld overlay (acc. item A.7.1.7.3)	
12. Obturator Material	AISI 316 + Tungsten carbide coating	
13. Seat Material	AISI 316 + Tungsten carbide coating	
14. Seat Insert	N/A	
15. Spring (Seat) Material	UNS N07750	
16. Stem Material	ASTM A276 (UNS S31600)	
17. Seat-Stem Seal	Group E (acc. item A.7.1.5.6)	
18. Operator Type	2" - 4" Lever	6" - 36" Gearbox
19. Additional Requirement	N/A	
20. Seat Type	(For trunnion-mounted) Side A: SPE / Side B: DPE; DIB-2 & DBB	
21. Bore Type	Full Bore	
22. Body Construction	split body, bolted	
23. Cladding or Coating	Partial clad - Inconel 625 weld overlay on all body sealing areas	
24. Valve Testing	FAT according A.9.3	
25. Notes	Acceptance criteria for sealing tests see Annex A	

Valve Code	VES-150-3-C273	
Specs	B6	
1. Valve Type	Ball	
2. Sealing Type	Metal to Metal	
3. Valve Specification Level (VSL)	VSL-3	
4. Ball Mouting	2" - 4" Floating	6" - 36" Trunnion
5. Standard	API 6D	
6. Size Range (NPS)	2" - 36"	
7. End Connection	RF	
8. Pressure Class	150	
9. Temperature	-46°C to 200°C	
10. Material Class	Low-Temperature Carbon Steel	
11. Body Material	ASTM A350 Gr LF2 CL1 + Inconel 625 weld overlay (acc. item A.7.1.7.3)	
12. Obturator Material	AISI 316 + Tungsten carbide coating	
13. Seat Material	AISI 316 + Tungsten carbide coating	
14. Seat Insert	N/A	
15. Spring (Seat) Material	UNS N07750	
16. Stem Material	ASTM A276 (UNS S31600)	
17. Seat-Stem Seal	Group E (acc. item A.7.1.5.6)	
18. Operator Type	2" - 4" Lever	6" - 36" Gearbox
19. Additional Requirement	Fire Tested (acc. item A.6.1.4)	
20. Seat Type	(For trunnion-mounted) Side A: SPE / Side B: DPE; DIB-2 & DBB	
21. Bore Type	Full Bore	
22. Body Construction	split body, bolted	
23. Cladding or Coating	Partial clad - Inconel 625 weld overlay on all body sealing areas	
24. Valve Testing	FAT according A.9.3	
25. Notes	Acceptance criteria for sealing tests see Annex A	

Valve Code	VES-150-3-C276	
Specs	B6	
1. Valve Type	Ball	
2. Sealing Type	Metal to Metal	
3. Valve Specification Level (VSL)	VSL-3	
4. Ball Mouting	2" - 4" Floating	6" - 36" Trunnion
5. Standard	API 6D	
6. Size Range (NPS)	2" - 36"	
7. End Connection	RF	
8. Pressure Class	150	
9. Temperature	-46°C to 200°C	
10. Material Class	Low-Temperature Carbon Steel	
11. Body Material	ASTM A350 Gr LF2 CL1 + Inconel 625 weld overlay (acc. item A.7.1.7.3)	
12. Obturator Material	AISI 316 + Tungsten carbide coating	
13. Seat Material	AISI 316 + Tungsten carbide coating	
14. Seat Insert	N/A	
15. Spring (Seat) Material	UNS N07750	
16. Stem Material	ASTM A276 (UNS S31600)	
17. Seat-Stem Seal	Group E (acc. item A.7.1.5.6)	
18. Operator Type	2" - 4" Lever	6" - 36" Gearbox
19. Additional Requirement	Fire Tested (acc. item A.6.1.4); Fugitive Emission (acc. item A.6.1.6)	
20. Seat Type	(For trunnion-mounted) Side A: SPE / Side B: DPE; DIB-2 & DBB	
21. Bore Type	Full Bore	
22. Body Construction	split body, bolted	
23. Cladding or Coating	Partial clad - Inconel 625 weld overlay on all body sealing areas	
24. Valve Testing	FAT according A.9.3	
25. Notes	Acceptance criteria for sealing tests see Annex A	

Valve Code	VES-150-3-C282	
Specs	B6	
1. Valve Type	Ball	
2. Sealing Type	Metal to Metal	
3. Valve Specification Level (VSL)	VSL-3	
4. Ball Mouting	2" - 4" Floating	6" - 36" Trunnion
5. Standard	API 6D	
6. Size Range (NPS)	2" - 36"	
7. End Connection	RF	
8. Pressure Class	150	
9. Temperature	-46°C to 345°C	
10. Material Class	Low-Temperature Carbon Steel	
11. Body Material	ASTM A350 Gr LF2 CL1 + Inconel 625 weld overlay (acc. item A.7.1.7.3)	
12. Obturator Material	AISI 316 + Chrome-Nickel Spray and Fuse (acc. item A.8.2.2.4)	
13. Seat Material	AISI 316 + Chrome-Nickel Spray and Fuse (acc. item A.8.2.2.4)	
14. Seat Insert	N/A	
15. Spring (Seat) Material	UNS N07750	
16. Stem Material	ASTM A276 (UNS S31600)	
17. Seat-Stem Seal	Group F (acc. item A.7.1.5.6)	
18. Operator Type	2" - 4" Lever	6" - 36" Gearbox
19. Additional Requirement	N/A	
20. Seat Type	(For trunnion-mounted) Side A: SPE / Side B: DPE; DIB-2 & DBB	
21. Bore Type	Full Bore	
22. Body Construction	split body, bolted	
23. Cladding or Coating	Partial clad - Inconel 625 weld overlay on all body sealing areas	
24. Valve Testing	FAT according A.9.3	
25. Notes	Acceptance criteria for sealing tests see Annex A	

Valve Code	VES-150-3-C283	
Specs	B6	
1. Valve Type	Ball	
2. Sealing Type	Metal to Metal	
3. Valve Specification Level (VSL)	VSL-3	
4. Ball Mouting	2" - 4" Floating	6" - 36" Trunnion
5. Standard	API 6D	
6. Size Range (NPS)	2" - 36"	
7. End Connection	RF	
8. Pressure Class	150	
9. Temperature	-46°C to 345°C	
10. Material Class	Low-Temperature Carbon Steel	
11. Body Material	ASTM A350 Gr LF2 CL1 + Inconel 625 weld overlay (acc. item A.7.1.7.3)	
12. Obturator Material	AISI 316 + Chrome-Nickel Spray and Fuse (acc. item A.8.2.2.4)	
13. Seat Material	AISI 316 + Chrome-Nickel Spray and Fuse (acc. item A.8.2.2.4)	
14. Seat Insert	N/A	
15. Spring (Seat) Material	UNS N07750	
16. Stem Material	ASTM A276 (UNS S31600)	
17. Seat-Stem Seal	Group F (acc. item A.7.1.5.6)	
18. Operator Type	2" - 4" Lever	6" - 36" Gearbox
19. Additional Requirement	Fire Tested (acc. item A.6.1.4)	
20. Seat Type	(For trunnion-mounted) Side A: SPE / Side B: DPE; DIB-2 & DBB	
21. Bore Type	Full Bore	
22. Body Construction	split body, bolted	
23. Cladding or Coating	Partial clad - Inconel 625 weld overlay on all body sealing areas	
24. Valve Testing	FAT according A.9.3	
25. Notes	Acceptance criteria for sealing tests see Annex A	



Valve Code	VES-150-3-C28G	
Specs	B6	
1. Valve Type	Ball	
2. Sealing Type	Metal to Metal	
3. Valve Specification Level (VSL)	VSL-3	
4. Ball Mouting	2" - 4" Floating	6" - 36" Trunnion
5. Standard	API 6D	
6. Size Range (NPS)	2" - 36"	
7. End Connection	RF	
8. Pressure Class	150	
9. Temperature	-46°C to 345°C	
10. Material Class	Low-Temperature Carbon Steel	
11. Body Material	ASTM A350 Gr LF2 CL1 + Inconel 625 weld overlay (acc. item A.7.1.7.3)	
12. Obturator Material	AISI 316 + Chrome-Nickel Spray and Fuse (acc. item A.8.2.2.4)	
13. Seat Material	AISI 316 + Chrome-Nickel Spray and Fuse (acc. item A.8.2.2.4)	
14. Seat Insert	N/A	
15. Spring (Seat) Material	UNS N07750	
16. Stem Material	ASTM A276 (UNS S31600)	
17. Seat-Stem Seal	Group F (acc. item A.7.1.5.6)	
18. Operator Type	2" - 4" Lever	6" - 36" Gearbox
19. Additional Requirement	Fire Tested (acc. item A.6.1.4); Fugitive Emission (acc. item A.6.1.6)	
20. Seat Type	(For trunnion-mounted) Side A: SPE / Side B: DPE; DIB-2 & DBB	
21. Bore Type	Full Bore	
22. Body Construction	split body, bolted	
23. Cladding or Coating	Partial clad - Inconel 625 weld overlay on all body sealing areas	
24. Valve Testing	FAT according A.9.3	
25. Notes	Acceptance criteria for sealing tests see Annex A	

Valve Code	VES-150-3-C526	
Specs	B30	
1. Valve Type	Ball	
2. Sealing Type	Soft	
3. Valve Specification Level (VSL)	VSL-3	
4. Ball Mouting	2" - 4" Floating	6" - 30" Trunnion
5. Standard	API 6D / IOGP S-562	
6. Size Range (NPS)	2" - 30"	
7. End Connection	RF	
8. Pressure Class	150	
9. Temperature	0°C to 150°C	
10. Material Class	Carbon Steel with Cladding	
11. Body Material	ASTM A105 + Inconel 625 weld overlay (acc. item A.7.1.7.3)	
12. Obturator Material	ASTM A105 + Inconel 625 weld overlay (acc. item A.7.1.7.3)	
13. Seat Material	ASTM A105 + Inconel 625 weld overlay (acc. item A.7.1.7.3)	
14. Seat Insert	PTFE reinforced with 25% Carbon	
15. Spring (Seat) Material	UNS N07750	
16. Stem Material	ASTM B637 (UNS N07718)	
17. Seat-Stem Seal	Group C (acc. item A.7.1.5.6)	
18. Operator Type	2" - 4" Lever	6" - 30" Gearbox
19. Additional Requirement	N/A	
20. Seat Type	(For trunnion-mounted) Side A: SPE / Side B: DPE; DIB-2 & DBB	
21. Bore Type	Full Bore	
22. Body Construction	split body, bolted	
23. Cladding or Coating	Full clad - Inconel 625 weld overlay on all wetted parts	
24. Valve Testing	FAT according A.9.3	
25. Notes	N/A	

Valve Code	VES-150-3-C527	
Specs	B30	
1. Valve Type	Ball	
2. Sealing Type	Soft	
3. Valve Specification Level (VSL)	VSL-3	
4. Ball Mouting	2" - 4" Floating	6" - 30" Trunnion
5. Standard	API 6D / IOGP S-562	
6. Size Range (NPS)	2" - 30"	
7. End Connection	RF	
8. Pressure Class	150	
9. Temperature	0°C to 150°C	
10. Material Class	Carbon Steel with Cladding	
11. Body Material	ASTM A105 + Inconel 625 weld overlay (acc. item A.7.1.7.3)	
12. Obturator Material	ASTM A105 + Inconel 625 weld overlay (acc. item A.7.1.7.3)	
13. Seat Material	ASTM A105 + Inconel 625 weld overlay (acc. item A.7.1.7.3)	
14. Seat Insert	PTFE reinforced with 25% Carbon	
15. Spring (Seat) Material	UNS N07750	
16. Stem Material	ASTM B637 (UNS N07718)	
17. Seat-Stem Seal	Group C (acc. item A.7.1.5.6)	
18. Operator Type	2" - 4" Lever	6" - 30" Gearbox
19. Additional Requirement	Fire Tested (acc. item A.6.1.4)	
20. Seat Type	(For trunnion-mounted) Side A: SPE / Side B: DPE; DIB-2 & DBB	
21. Bore Type	Full Bore	
22. Body Construction	split body, bolted	
23. Cladding or Coating	Full clad - Inconel 625 weld overlay on all wetted parts	
24. Valve Testing	FAT according A.9.3	
25. Notes	N/A	

Valve Code	VES-150-3-C536	
Specs	B30	
1. Valve Type	Ball	
2. Sealing Type	Soft	
3. Valve Specification Level (VSL)	VSL-3	
4. Ball Mouting	2" - 4" Floating	6" - 30" Trunnion
5. Standard	API 6D / IOGP S-562	
6. Size Range (NPS)	2" - 30"	
7. End Connection	RF	
8. Pressure Class	150	
9. Temperature	0°C to 150°C	
10. Material Class	Carbon Steel with Cladding	
11. Body Material	ASTM A105 + Inconel 625 weld overlay (acc. item A.7.1.7.3)	
12. Obturator Material	ASTM A105 + Inconel 625 weld overlay (acc. item A.7.1.7.3)	
13. Seat Material	ASTM A105 + Inconel 625 weld overlay (acc. item A.7.1.7.3)	
14. Seat Insert	PTFE reinforced with 25% Carbon	
15. Spring (Seat) Material	UNS N07750	
16. Stem Material	ASTM B637 (UNS N07718)	
17. Seat-Stem Seal	Group D (acc. item A.7.1.5.6)	
18. Operator Type	2" - 4" Lever	6" - 30" Gearbox
19. Additional Requirement	N/A	
20. Seat Type	(For trunnion-mounted) Side A: SPE / Side B: DPE; DIB-2 & DBB	
21. Bore Type	Full Bore	
22. Body Construction	split body, bolted	
23. Cladding or Coating	Full clad - Inconel 625 weld overlay on all wetted parts	
24. Valve Testing	FAT according A.9.3	
25. Notes	N/A	

Valve Code	VES-150-3-C537	
Specs	B30	
1. Valve Type	Ball	
2. Sealing Type	Soft	
3. Valve Specification Level (VSL)	VSL-3	
4. Ball Mouting	2" - 4" Floating	6" - 30" Trunnion
5. Standard	API 6D / IOGP S-562	
6. Size Range (NPS)	2" - 30"	
7. End Connection	RF	
8. Pressure Class	150	
9. Temperature	0°C to 150°C	
10. Material Class	Carbon Steel with Cladding	
11. Body Material	ASTM A105 + Inconel 625 weld overlay (acc. item A.7.1.7.3)	
12. Obturator Material	ASTM A105 + Inconel 625 weld overlay (acc. item A.7.1.7.3)	
13. Seat Material	ASTM A105 + Inconel 625 weld overlay (acc. item A.7.1.7.3)	
14. Seat Insert	PTFE reinforced with 25% Carbon	
15. Spring (Seat) Material	UNS N07750	
16. Stem Material	ASTM B637 (UNS N07718)	
17. Seat-Stem Seal	Group D (acc. item A.7.1.5.6)	
18. Operator Type	2" - 4" Lever	6" - 30" Gearbox
19. Additional Requirement	Fire Tested (acc. item A.6.1.4)	
20. Seat Type	(For trunnion-mounted) Side A: SPE / Side B: DPE; DIB-2 & DBB	
21. Bore Type	Full Bore	
22. Body Construction	split body, bolted	
23. Cladding or Coating	Full clad - Inconel 625 weld overlay on all wetted parts	
24. Valve Testing	FAT according A.9.3	
25. Notes	N/A	

Valve Code	VES-150-3-C53G	
Specs	B30	
1. Valve Type	Ball	
2. Sealing Type	Soft	
3. Valve Specification Level (VSL)	VSL-3	
4. Ball Mouting	2" - 4" Floating	6" - 30" Trunnion
5. Standard	API 6D / IOGP S-562	
6. Size Range (NPS)	2" - 30"	
7. End Connection	RF	
8. Pressure Class	150	
9. Temperature	0°C to 150°C	
10. Material Class	Carbon Steel with Cladding	
11. Body Material	ASTM A105 + Inconel 625 weld overlay (acc. item A.7.1.7.3)	
12. Obturator Material	ASTM A105 + Inconel 625 weld overlay (acc. item A.7.1.7.3)	
13. Seat Material	ASTM A105 + Inconel 625 weld overlay (acc. item A.7.1.7.3)	
14. Seat Insert	PTFE reinforced with 25% Carbon	
15. Spring (Seat) Material	UNS N07750	
16. Stem Material	ASTM B637 (UNS N07718)	
17. Seat-Stem Seal	Group D (acc. item A.7.1.5.6)	
18. Operator Type	2" - 4" Lever	6" - 30" Gearbox
19. Additional Requirement	Fire Tested (acc. item A.6.1.4); Fugitive Emission (acc. item A.6.1.6)	
20. Seat Type	(For trunnion-mounted) Side A: SPE / Side B: DPE; DIB-2 & DBB	
21. Bore Type	Full Bore	
22. Body Construction	split body, bolted	
23. Cladding or Coating	Full clad - Inconel 625 weld overlay on all wetted parts	
24. Valve Testing	FAT according A.9.3	
25. Notes	N/A	

Valve Code	VES-150-3-C553	
Specs	B30	
1. Valve Type	Ball	
2. Sealing Type	Metal to Metal	
3. Valve Specification Level (VSL)	VSL-3	
4. Ball Mouting	2" - 4" Floating	6" - 30" Trunnion
5. Standard	API 6D / IOGP S-562	
6. Size Range (NPS)	2" - 30"	
7. End Connection	RF	
8. Pressure Class	150	
9. Temperature	-29°C to 150°C	
10. Material Class	Carbon Steel with Cladding	
11. Body Material	ASTM A105 + Inconel 625 weld overlay (acc. item A.7.1.7.3)	
12. Obturator Material	ASTM A105 + Inconel 625 weld overlay (acc. item A.7.1.7.3) + Tungsten carbide coating	
13. Seat Material	ASTM A105 + Inconel 625 weld overlay (acc. item A.7.1.7.3) + Tungsten carbide coating	
14. Seat Insert	N/A	
15. Spring (Seat) Material	UNS N07750	
16. Stem Material	ASTM B637 (UNS N07718)	
17. Seat-Stem Seal	Group B (acc. item A.7.1.5.6)	
18. Operator Type	2" - 4" Lever	6" - 30" Gearbox
19. Additional Requirement	Fire Tested (acc. item A.6.1.4)	
20. Seat Type	(For trunnion-mounted) Side A: SPE / Side B: DPE; DIB-2 & DBB	
21. Bore Type	Full Bore	
22. Body Construction	split body, bolted	
23. Cladding or Coating	Full clad - Inconel 625 weld overlay on all wetted parts	
24. Valve Testing	FAT according A.9.3	
25. Notes	Acceptance criteria for sealing tests see Annex A	

Valve Code	VES-150-3-C55G	
Specs	B30	
1. Valve Type	Ball	
2. Sealing Type	Metal to Metal	
3. Valve Specification Level (VSL)	VSL-3	
4. Ball Mouting	2" - 4" Floating	6" - 30" Trunnion
5. Standard	API 6D / IOGP S-562	
6. Size Range (NPS)	2" - 30"	
7. End Connection	RF	
8. Pressure Class	150	
9. Temperature	-29°C to 150°C	
10. Material Class	Carbon Steel with Cladding	
11. Body Material	ASTM A105 + Inconel 625 weld overlay (acc. item A.7.1.7.3)	
12. Obturator Material	ASTM A105 + Inconel 625 weld overlay (acc. item A.7.1.7.3) + Tungsten carbide coating	
13. Seat Material	ASTM A105 + Inconel 625 weld overlay (acc. item A.7.1.7.3) + Tungsten carbide coating	
14. Seat Insert	N/A	
15. Spring (Seat) Material	UNS N07750	
16. Stem Material	ASTM B637 (UNS N07718)	
17. Seat-Stem Seal	Group B (acc. item A.7.1.5.6)	
18. Operator Type	2" - 4" Lever	6" - 30" Gearbox
19. Additional Requirement	Fire Tested (acc. item A.6.1.4); Fugitive Emission (acc. item A.6.1.6)	
20. Seat Type	(For trunnion-mounted) Side A: SPE / Side B: DPE; DIB-2 & DBB	
21. Bore Type	Full Bore	
22. Body Construction	split body, bolted	
23. Cladding or Coating	Full clad - Inconel 625 weld overlay on all wetted parts	
24. Valve Testing	FAT according A.9.3	
25. Notes	Acceptance criteria for sealing tests see Annex A	















Valve Code	VES-150-3-S283	
Specs	B3	
1. Valve Type	Ball	
2. Sealing Type	Metal to Metal	
3. Valve Specification Level (VSL)	VSL-3	
4. Ball Mouting	2" - 4" Floating 6" - 36" Trunnion	
5. Standard	API 6D	
6. Size Range (NPS)	2" - 36"	
7. End Connection	RF	
8. Pressure Class	150	
9. Temperature	-100°C to 400°C	
10. Material Class	Stainless Steel	
11. Body Material	ASTM A182 Gr F316	
12. Obturator Material	AISI 316 + Chrome-Nickel Spray and Fuse (acc. Item A.8.2.2.4)	
13. Seat Material	AISI 316 + Chrome-Nickel Spray and Fuse (acc. Item A.8.2.2.4)	
14. Seat Insert	N/A	
15. Spring (Seat) Material	UNS N07718	
16. Stem Material	ASTM A276 (UNS S31600)	
17. Seat-Stem Seal	Group F (acc. item A.7.1.5.6)	
18. Operator Type	2" - 4" Lever 6" - 36" Gearbox	
19. Additional Requirement	Fire Tested (acc. item A.6.1.4)	
20. Seat Type	(For trunnion-mounted) Side A: SPE / Side B: DPE; DIB-2 & DBB	
21. Bore Type	Full Bore	
22. Body Construction	split body, bolted	
23. Cladding or Coating	N/A	
24. Valve Testing	FAT according A.9.3	
25. Notes	Acceptance criteria for sealing tests see Annex A	

Valve Code	VES-150-3-S28G	
Specs	B3	
1. Valve Type	Ball	
2. Sealing Type	Metal to Metal	
3. Valve Specification Level (VSL)	VSL-3	
4. Ball Mouting	2" - 4" Floating 6" - 36" Trunnion	
5. Standard	API 6D	
6. Size Range (NPS)	2" - 36"	
7. End Connection	RF	
8. Pressure Class	150	
9. Temperature	-100°C to 400°C	
10. Material Class	Stainless Steel	
11. Body Material	ASTM A182 Gr F316	
12. Obturator Material	AISI 316 + Chrome-Nickel Spray and Fuse (acc. Item A.8.2.2.4)	
13. Seat Material	AISI 316 + Chrome-Nickel Spray and Fuse (acc. Item A.8.2.2.4)	
14. Seat Insert	N/A	
15. Spring (Seat) Material	UNS N07718	
16. Stem Material	ASTM A276 (UNS S31600)	
17. Seat-Stem Seal	Group F (acc. item A.7.1.5.6)	
18. Operator Type	2" - 4" Lever 6" - 36" Gearbox	
19. Additional Requirement	Fire Tested (acc. item A.6.1.4); Fugitive Emission (acc. item A.6.1.6)	
20. Seat Type	(For trunnion-mounted) Side A: SPE / Side B: DPE; DIB-2 & DBB	
21. Bore Type	Full Bore	
22. Body Construction	split body, bolted	
23. Cladding or Coating	N/A	
24. Valve Testing	FAT according A.9.3	
25. Notes	Acceptance criteria for sealing tests see Annex A	

Valve Code	VES-150-4-C154	
Specs	B9	
1. Valve Type	Ball	
2. Sealing Type	Metal to Metal	
3. Valve Specification Level (VSL)	VSL-4	
4. Ball Mouting	2" - 4" Floating 6" - 36" Trunnion	
5. Standard	API 6D / IOGP S-562	
6. Size Range (NPS)	2" - 36"	
7. End Connection	RF	
8. Pressure Class	150	
9. Temperature	0°C to 150°C	
10. Material Class	Carbon Steel	
11. Body Material	ASTM A105 + SS316 weld overlay (acc. item A.7.1.7.3)	
12. Obturator Material	AISI 410 + Tungsten carbide coating	
13. Seat Material	AISI 410 + Tungsten carbide coating	
14. Seat Insert	N/A	
15. Spring (Seat) Material	UNS N07750	
16. Stem Material	ASTM A276 (UNS S41000)	
17. Seat-Stem Seal	Group A (acc. item A.7.1.5.6)	
18. Operator Type	Actuated	
19. Additional Requirement	Fire Tested (acc. item A.6.1.4)	
20. Seat Type	(For trunnion-mounted) Side A: SPE / Side B: DPE; DIB-2 & DBB (notes)	
21. Bore Type	Full Bore	
22. Body Construction	split body, bolted	
23. Cladding or Coating	Partial clad - SS316 weld overlay on all body sealing areas	
24. Valve Testing	FAT according A.9.3	
25. Notes	Acceptance criteria for sealing tests see Annex A, DBB tests to be performed at both conditions, fully opened and closed, Vent and drain connections according Annex A	

Valve Code	VES-150-4-C164	
Specs	B9	
1. Valve Type	Ball	
2. Sealing Type	Metal to Metal	
3. Valve Specification Level (VSL)	VSL-4	
4. Ball Mouting	Trunnion	
5. Standard	API 6D	
6. Size Range (NPS)	6" - 36"	
7. End Connection	RF	
8. Pressure Class	150	
9. Temperature	0°C to 210°C	
10. Material Class	Carbon Steel	
11. Body Material	ASTM A105 + SS316 weld overlay (acc. item A.7.1.7.3)	
12. Obturator Material	AISI 410 + Tungsten carbide coating	
13. Seat Material	AISI 410 + Tungsten carbide coating	
14. Seat Insert	N/A	
15. Spring (Seat) Material	UNS N07750	
16. Stem Material	ASTM A276 (UNS S41000)	
17. Seat-Stem Seal	Group C (acc. item A.7.1.5.6)	
18. Operator Type	Actuated	
19. Additional Requirement	Fire Tested (acc. item A.6.1.4)	
20. Seat Type	(For trunnion-mounted) Side A: SPE / Side B: DPE; DIB-2 & DBB (notes)	
21. Bore Type	Full Bore	
22. Body Construction	split body, bolted	
23. Cladding or Coating	Partial clad - SS316 weld overlay on all body sealing areas	
24. Valve Testing	FAT according A.9.3	
25. Notes	Acceptance criteria for sealing tests see Annex A, DBB tests to be performed at both conditions, fully opened and closed, Vent and drain connections according Annex A	

Valve Code	VES-150-4-C174	
Specs	B9	
1. Valve Type	Ball	
2. Sealing Type	Metal to Metal	
3. Valve Specification Level (VSL)	VSL-4	
4. Ball Mouting	2" - 4" Floating 6" - 36" Trunnion	
5. Standard	API 6D	
6. Size Range (NPS)	2" - 36"	
7. End Connection	RF	
8. Pressure Class	150	
9. Temperature	0°C to 210°C	
10. Material Class	Carbon Steel	
11. Body Material	ASTM A105 + SS316 weld overlay (acc. item A.7.1.7.3)	
12. Obturator Material	AISI 410 + Tungsten carbide coating	
13. Seat Material	AISI 410 + Tungsten carbide coating	
14. Seat Insert	N/A	
15. Spring (Seat) Material	UNS N07750	
16. Stem Material	ASTM A276 (UNS S41000)	
17. Seat-Stem Seal	Group D (acc. item A.7.1.5.6)	
18. Operator Type	Actuated	
19. Additional Requirement	Fire Tested (acc. item A.6.1.4)	
20. Seat Type	(For trunnion-mounted) Side A: SPE / Side B: DPE; DIB-2 & DBB (notes)	
21. Bore Type	Full Bore	
22. Body Construction	split body, bolted	
23. Cladding or Coating	Partial clad - SS316 weld overlay on all body sealing areas	
24. Valve Testing	FAT according A.9.3	
25. Notes	Acceptance criteria for sealing tests see Annex A, DBB tests to be performed at both conditions, fully opened and closed, Vent and drain connections according Annex A	

Valve Code	VES-150-4-C184	
Specs	B9	
1. Valve Type	Ball	
2. Sealing Type	Metal to Metal	
3. Valve Specification Level (VSL)	VSL-4	
4. Ball Mouting	Trunnion	
5. Standard	API 6D	
6. Size Range (NPS)	6" - 36"	
7. End Connection	RF	
8. Pressure Class	150	
9. Temperature	0°C to 400°C	
10. Material Class	Carbon Steel	
11. Body Material	ASTM A105 + SS316 weld overlay (acc. item A.7.1.7.3)	
12. Obturator Material	AISI 410 + Chrome-Nickel Spray and Fuse (acc. Item A.8.2.2.4)	
13. Seat Material	AISI 410 + Chrome-Nickel Spray and Fuse (acc. Item A.8.2.2.4)	
14. Seat Insert	N/A	
15. Spring (Seat) Material	UNS N07750	
16. Stem Material	ASTM A276 (UNS S41000)	
17. Seat-Stem Seal	Group F (acc. item A.7.1.5.6)	
18. Operator Type	Actuated	
19. Additional Requirement	Fire Tested (acc. item A.6.1.4)	
20. Seat Type	(For trunnion-mounted) Side A: SPE / Side B: DPE; DIB-2 & DBB (notes)	
21. Bore Type	Full Bore	
22. Body Construction	split body, bolted	
23. Cladding or Coating	Partial clad - SS316 weld overlay on all body sealing areas	
24. Valve Testing	FAT according A.9.3	
25. Notes	Acceptance criteria for sealing tests see Annex A, DBB tests to be performed at both conditions, fully opened and closed, Vent and drain connections according Annex A	

Valve Code	VES-2502-1-D208	
Specs	H16	
1. Valve Type	Ball	
2. Sealing Type	Soft	
3. Valve Specification Level (VSL)	VSL-1	
4. Ball Mouting	Trunnion	
5. Standard	ASME B16.34 LTD	
6. Size Range (NPS)	1" - 1 1/2"	
7. End Connection	butt weld ASME B16.25 with nipple SCH 80S	
8. Pressure Class	2500	
9. Temperature	-30°C to 120°C	
10. Material Class	Duplex Steel	
11. Body Material	ASTM A182 Gr F51	
12. Obturator Material	Duplex (UNS S31803)	
13. Seat Material	Duplex (UNS S31803)	
14. Seat Insert	PEEK	
15. Spring (Seat) Material	UNS N07750	
16. Stem Material	ASTM A276 (UNS S31803)	
17. Seat-Stem Seal	Group B (acc. item A.7.1.5.6)	
18. Operator Type	Lever	
19. Additional Requirement	Fire Tested (acc. item A.6.1.4)	
20. Seat Type	(For trunnion-mounted) Side A: SPE / Side B: SPE	
21. Bore Type	Full Bore	
22. Body Construction	split body, bolted	
23. Cladding or Coating	N/A	
24. Valve Testing	FAT according A.9.3	
25. Notes	N/A	

Valve Code	VES-2502-1-D209	
Specs	H16	
1. Valve Type	Ball	
2. Sealing Type	Metal to Metal	
3. Valve Specification Level (VSL)	VSL-1	
4. Ball Mouting	Trunnion	
5. Standard	ASME B16.34 LTD	
6. Size Range (NPS)	1" - 1 1/2"	
7. End Connection	butt weld ASME B16.25 with nipple SCH 80S	
8. Pressure Class	2500	
9. Temperature	-46°C to 150°C	
10. Material Class	Duplex Steel	
11. Body Material	ASTM A182 Gr F51	
12. Obturator Material	Duplex (UNS S31803) + Hard Coating (acc. Item A.7.1.7.4)	
13. Seat Material	Duplex (UNS S31803) + Hard Coating (acc. Item A.7.1.7.4)	
14. Seat Insert	N/A	
15. Spring (Seat) Material	UNS N07750	
16. Stem Material	ASTM A276 (UNS S31803)	
17. Seat-Stem Seal	Group E (acc. item A.7.1.5.6)	
18. Operator Type	Lever	
19. Additional Requirement	Fire Tested (acc. item A.6.1.4)	
20. Seat Type	(For trunnion-mounted) Side A: SPE / Side B: SPE	
21. Bore Type	Full Bore	
22. Body Construction	split body, bolted	
23. Cladding or Coating	N/A	
24. Valve Testing	FAT according A.9.3	
25. Notes	N/A	

Valve Code	VES-2502-1-N108	
Specs	H30	
1. Valve Type	Ball	
2. Sealing Type	Soft	
3. Valve Specification Level (VSL)	VSL-1	
4. Ball Mouting	Trunnion	
5. Standard	ASME B16.34 LTD	
6. Size Range (NPS)	1" - 1 1/2"	
7. End Connection	butt weld ASME B16.25 with nipple SCH 80S	
8. Pressure Class	2500	
9. Temperature	-30°C to 120°C	
10. Material Class	Nickel Alloys	
11. Body Material	ASTM B564 (UNS N06625)	
12. Obturator Material	ASTM B564 (UNS N06625)	
13. Seat Material	ASTM B564 (UNS N06625)	
14. Seat Insert	PEEK	
15. Spring (Seat) Material	UNS N07750	
16. Stem Material	ASTM B637 (UNS N07718)	
17. Seat-Stem Seal	Group B (acc. item A.7.1.5.6)	
18. Operator Type	Lever	
19. Additional Requirement	Fire Tested (acc. item A.6.1.4)	
20. Seat Type	(For trunnion-mounted) Side A: SPE / Side B: SPE	
21. Bore Type	Full Bore	
22. Body Construction	split body, bolted	
23. Cladding or Coating	N/A	
24. Valve Testing	FAT according A.9.3	
25. Notes	N/A	

Valve Code	VES-2502-1-N109	
Specs	H30	
1. Valve Type	Ball	
2. Sealing Type	Metal to Metal	
3. Valve Specification Level (VSL)	VSL-1	
4. Ball Mouting	Trunnion	
5. Standard	ASME B16.34 LTD	
6. Size Range (NPS)	1" - 1 1/2"	
7. End Connection	butt weld ASME B16.25 with nipple SCH 80S	
8. Pressure Class	2500	
9. Temperature	-100°C to 200°C	
10. Material Class	Nickel Alloys	
11. Body Material	ASTM B564 (UNS N06625)	
12. Obturator Material	ASTM B564 (UNS N06625) + Hard Coating (acc. Item A.7.1.7.4)	
13. Seat Material	ASTM B564 (UNS N06625) + Hard Coating (acc. Item A.7.1.7.4)	
14. Seat Insert	N/A	
15. Spring (Seat) Material	UNS N07750	
16. Stem Material	ASTM B637 (UNS N07718)	
17. Seat-Stem Seal	Group E (acc. item A.7.1.5.6)	
18. Operator Type	Lever	
19. Additional Requirement	Fire Tested (acc. item A.6.1.4)	
20. Seat Type	(For trunnion-mounted) Side A: SPE / Side B: SPE	
21. Bore Type	Full Bore	
22. Body Construction	split body, bolted	
23. Cladding or Coating	N/A	
24. Valve Testing	FAT according A.9.3	
25. Notes	N/A	

Valve Code	VES-2502-2-D208	
Specs	H16	
1. Valve Type	Ball	
2. Sealing Type	Soft	
3. Valve Specification Level (VSL)	VSL-2	
4. Ball Mouting	Trunnion	
5. Standard	ASME B16.34 LTD	
6. Size Range (NPS)	1" - 1 1/2"	
7. End Connection	butt weld ASME B16.25 with nipple SCH 80S	
8. Pressure Class	2500	
9. Temperature	-30°C to 120°C	
10. Material Class	Duplex Steel	
11. Body Material	ASTM A182 Gr F51	
12. Obturator Material	Duplex (UNS S31803)	
13. Seat Material	Duplex (UNS S31803)	
14. Seat Insert	PEEK	
15. Spring (Seat) Material	UNS N07750	
16. Stem Material	ASTM A276 (UNS S31803)	
17. Seat-Stem Seal	Group B (acc. item A.7.1.5.6)	
18. Operator Type	Lever	
19. Additional Requirement	Fire Tested (acc. item A.6.1.4)	
20. Seat Type	(For trunnion-mounted) Side A: SPE / Side B: SPE	
21. Bore Type	Full Bore	
22. Body Construction	split body, bolted	
23. Cladding or Coating	N/A	
24. Valve Testing	FAT according A.9.3	
25. Notes	N/A	

Valve Code	VES-2502-2-D209	
Specs	H16	
1. Valve Type	Ball	
2. Sealing Type	Metal to Metal	
3. Valve Specification Level (VSL)	VSL-2	
4. Ball Mouting	Trunnion	
5. Standard	ASME B16.34 LTD	
6. Size Range (NPS)	1" - 1 1/2"	
7. End Connection	butt weld ASME B16.25 with nipple SCH 80S	
8. Pressure Class	2500	
9. Temperature	-46°C to 150°C	
10. Material Class	Duplex Steel	
11. Body Material	ASTM A182 Gr F51	
12. Obturator Material	Duplex (UNS S31803) + Hard Coating (acc. Item A.7.1.7.4)	
13. Seat Material	Duplex (UNS S31803) + Hard Coating (acc. Item A.7.1.7.4)	
14. Seat Insert	N/A	
15. Spring (Seat) Material	UNS N07750	
16. Stem Material	ASTM A276 (UNS S31803)	
17. Seat-Stem Seal	Group E (acc. item A.7.1.5.6)	
18. Operator Type	Lever	
19. Additional Requirement	Fire Tested (acc. item A.6.1.4)	
20. Seat Type	(For trunnion-mounted) Side A: SPE / Side B: SPE	
21. Bore Type	Full Bore	
22. Body Construction	split body, bolted	
23. Cladding or Coating	N/A	
24. Valve Testing	FAT according A.9.3	
25. Notes	N/A	



























Valve Code	VES-2510-3-S262
Specs	H3
1. Valve Type	Ball
2. Sealing Type	Metal to Metal
3. Valve Specification Level (VSL)	VSL-3
4. Ball Mouting	Trunnion
5. Standard	API 6D
6. Size Range (NPS)	2" - 16"
7. End Connection	ISO 27509, IX
8. Pressure Class	2500
9. Temperature	0°C to 210°C
10. Material Class	Stainless Steel
11. Body Material	ASTM A182 Gr F316
12. Obturator Material	AISI 316 + Tungsten carbide coating
13. Seat Material	AISI 316 + Tungsten carbide coating
14. Seat Insert	N/A
15. Spring (Seat) Material	UNS N07750
16. Stem Material	ASTM A276 (UNS S31803)
17. Seat-Stem Seal	Group C (acc. item A.7.1.5.6)
18. Operator Type	Gearbox
19. Additional Requirement	N/A
20. Seat Type	(For trunnion-mounted) Side A: SPE / Side B: DPE; DIB-2 & DBB
21. Bore Type	Full Bore
22. Body Construction	split body, bolted
23. Cladding or Coating	N/A
24. Valve Testing	FAT according A.9.3
25. Notes	Acceptance criteria for sealing tests see Annex A

Valve Code	VES-2510-3-S263
Specs	H3
1. Valve Type	Ball
2. Sealing Type	Metal to Metal
3. Valve Specification Level (VSL)	VSL-3
4. Ball Mouting	Trunnion
5. Standard	API 6D
6. Size Range (NPS)	2" - 16"
7. End Connection	ISO 27509, IX
8. Pressure Class	2500
9. Temperature	0°C to 210°C
10. Material Class	Stainless Steel
11. Body Material	ASTM A182 Gr F316
12. Obturator Material	AISI 316 + Tungsten carbide coating
13. Seat Material	AISI 316 + Tungsten carbide coating
14. Seat Insert	N/A
15. Spring (Seat) Material	UNS N07750
16. Stem Material	ASTM B637 (UNS N07718)
17. Seat-Stem Seal	Group C (acc. item A.7.1.5.6)
18. Operator Type	Gearbox
19. Additional Requirement	Fire Tested (acc. item A.6.1.4)
20. Seat Type	(For trunnion-mounted) Side A: SPE / Side B: DPE; DIB-2 & DBB
21. Bore Type	Full Bore
22. Body Construction	split body, bolted
23. Cladding or Coating	N/A
24. Valve Testing	FAT according A.9.3
25. Notes	Acceptance criteria for sealing tests see Annex A

Valve Code	VES-2510-3-S272
Specs	H3
1. Valve Type	Ball
2. Sealing Type	Metal to Metal
3. Valve Specification Level (VSL)	VSL-3
4. Ball Mouting	Trunnion
5. Standard	API 6D
6. Size Range (NPS)	2" - 16"
7. End Connection	ISO 27509, IX
8. Pressure Class	2500
9. Temperature	-100°C to 200°C
10. Material Class	Stainless Steel
11. Body Material	ASTM A182 Gr F316
12. Obturator Material	AISI 316 + Tungsten carbide coating
13. Seat Material	AISI 316 + Tungsten carbide coating
14. Seat Insert	N/A
15. Spring (Seat) Material	UNS N07750
16. Stem Material	ASTM B637 (UNS N07718)
17. Seat-Stem Seal	Group E (acc. item A.7.1.5.6)
18. Operator Type	Gearbox
19. Additional Requirement	N/A
20. Seat Type	(For trunnion-mounted) Side A: SPE / Side B: DPE; DIB-2 & DBB
21. Bore Type	Full Bore
22. Body Construction	split body, bolted
23. Cladding or Coating	N/A
24. Valve Testing	FAT according A.9.3
25. Notes	Acceptance criteria for sealing tests see Annex A

Valve Code	VES-2510-3-S273
Specs	H3
1. Valve Type	Ball
2. Sealing Type	Metal to Metal
3. Valve Specification Level (VSL)	VSL-3
4. Ball Mouting	Trunnion
5. Standard	API 6D
6. Size Range (NPS)	2" - 16"
7. End Connection	ISO 27509, IX
8. Pressure Class	2500
9. Temperature	-100°C to 200°C
10. Material Class	Stainless Steel
11. Body Material	ASTM A182 Gr F316
12. Obturator Material	AISI 316 + Tungsten carbide coating
13. Seat Material	AISI 316 + Tungsten carbide coating
14. Seat Insert	N/A
15. Spring (Seat) Material	UNS N07750
16. Stem Material	ASTM B637 (UNS N07718)
17. Seat-Stem Seal	Group E (acc. item A.7.1.5.6)
18. Operator Type	Gearbox
19. Additional Requirement	Fire Tested (acc. item A.6.1.4)
20. Seat Type	(For trunnion-mounted) Side A: SPE / Side B: DPE; DIB-2 & DBB
21. Bore Type	Full Bore
22. Body Construction	split body, bolted
23. Cladding or Coating	N/A
24. Valve Testing	FAT according A.9.3
25. Notes	Acceptance criteria for sealing tests see Annex A

Valve Code	VES-2510-3-S27G
Specs	H3
1. Valve Type	Ball
2. Sealing Type	Metal to Metal
3. Valve Specification Level (VSL)	VSL-3
4. Ball Mouting	Trunnion
5. Standard	API 6D
6. Size Range (NPS)	2" - 16"
7. End Connection	ISO 27509, IX
8. Pressure Class	2500
9. Temperature	-100°C to 200°C
10. Material Class	Stainless Steel
11. Body Material	ASTM A182 Gr F316
12. Obturator Material	AISI 316 + Tungsten carbide coating
13. Seat Material	AISI 316 + Tungsten carbide coating
14. Seat Insert	N/A
15. Spring (Seat) Material	UNS N07750
16. Stem Material	ASTM B637 (UNS N07718)
17. Seat-Stem Seal	Group E (acc. item A.7.1.5.6)
18. Operator Type	Gearbox
19. Additional Requirement	Fire Tested (acc. item A.6.1.4); Fugitive Emission (acc. item A.6.1.6)
20. Seat Type	(For trunnion-mounted) Side A: SPE / Side B: DPE; DIB-2 & DBB
21. Bore Type	Full Bore
22. Body Construction	split body, bolted
23. Cladding or Coating	N/A
24. Valve Testing	FAT according A.9.3
25. Notes	Acceptance criteria for sealing tests see Annex A

Valve Code	VES-2510-4-C574
Specs	H30
1. Valve Type	Ball
2. Sealing Type	Metal to Metal
3. Valve Specification Level (VSL)	VSL-4
4. Ball Mouting	Trunnion
5. Standard	API 6D
6. Size Range (NPS)	2" - 24"
7. End Connection	ISO 27509, IX
8. Pressure Class	2500
9. Temperature	-29°C to 200°C
10. Material Class	Carbon Steel with cladding
11. Body Material	ASTM A105 + Inconel 625 weld overlay (acc. item A.7.1.7.3)
12. Obturator Material	ASTM A105 + Inconel 625 weld overlay (acc. item A.7.1.7.3) + Tungsten carbide coating
13. Seat Material	ASTM A105 + Inconel 625 weld overlay (acc. item A.7.1.7.3) + Tungsten carbide coating
14. Seat Insert	N/A
15. Spring (Seat) Material	UNS N07750
16. Stem Material	ASTM B637 (UNS N07718)
17. Seat-Stem Seal	Group E (acc. item A.7.1.5.6)
18. Operator Type	Actuated
19. Additional Requirement	Fire Tested (acc. item A.6.1.4)
20. Seat Type	(For trunnion-mounted) Side A: SPE / Side B: DPE; DIB-2 & DBB (notes)
21. Bore Type	Full Bore
22. Body Construction	split body, bolted
23. Cladding or Coating	Full clad - Inconel 625 weld overlay on all wetted parts
24. Valve Testing	FAT according A.9.3
25. Notes	Acceptance criteria for sealing tests see Annex A, DBB tests to be performed at both conditions, fully opened and closed, Vent and drain connections according Annex A

Valve Code	VES-2510-4-C575
Specs	H30
1. Valve Type	Ball
2. Sealing Type	Metal to Metal
3. Valve Specification Level (VSL)	VSL-4
4. Ball Mouting	Trunnion
5. Standard	API 6D
6. Size Range (NPS)	4" - 24"
7. End Connection	ISO 27509, IX
8. Pressure Class	2500
9. Temperature	-29°C to 200°C
10. Material Class	Carbon Steel with cladding
11. Body Material	ASTM A105 + Inconel 625 weld overlay (acc. item A.7.1.7.3)
12. Obturator Material	ASTM A105 + Inconel 625 weld overlay (acc. item A.7.1.7.3) + Tungsten carbide coating
13. Seat Material	ASTM A105 + Inconel 625 weld overlay (acc. item A.7.1.7.3) + Tungsten carbide coating
14. Seat Insert	N/A
15. Spring (Seat) Material	UNS N07750
16. Stem Material	ASTM B637 (UNS N07718)
17. Seat-Stem Seal	Group E (acc. item A.7.1.5.6)
18. Operator Type	Actuated
19. Additional Requirement	Fire Tested (acc. item A.6.1.4), Fire Tested (acc. item A.6.1.4); SIL-3 (see notes)
20. Seat Type	(For trunnion-mounted) Side A: SPE / Side B: DPE; DIB-2 & DBB (notes)
21. Bore Type	Full Bore
22. Body Construction	split body, bolted
23. Cladding or Coating	Full clad - Inconel 625 weld overlay on all wetted parts
24. Valve Testing	FAT according A.9.3 and HIPPS in place test according A.9.3.7
25. Notes	Acceptance criteria for sealing tests see Annex A, DBB tests to be performed at both conditions, fully opened and closed, The manufacturer shall present all documentation in order to certify that SIL 3 requirements were achieved for the valve design, Vent and drain connections according Annex A

Valve Code	VES-2510-4-C57E
Specs	H30
1. Valve Type	Ball
2. Sealing Type	Metal to Metal
3. Valve Specification Level (VSL)	VSL-4
4. Ball Mouting	Trunnion
5. Standard	API 6D
6. Size Range (NPS)	2" - 24"
7. End Connection	ISO 27509, IX
8. Pressure Class	2500
9. Temperature	-29°C to 200°C
10. Material Class	Carbon Steel with cladding
11. Body Material	ASTM A105 + Inconel 625 weld overlay (acc. item A.7.1.7.3)
12. Obturator Material	ASTM A105 + Inconel 625 weld overlay (acc. item A.7.1.7.3) + Tungsten carbide coating
13. Seat Material	ASTM A105 + Inconel 625 weld overlay (acc. item A.7.1.7.3) + Tungsten carbide coating
14. Seat Insert	N/A
15. Spring (Seat) Material	UNS N07750
16. Stem Material	ASTM B637 (UNS N07718)
17. Seat-Stem Seal	Group E (acc. item A.7.1.5.6)
18. Operator Type	Actuated
19. Additional Requirement	Fire Tested (acc. item A.6.1.4); Fugitive Emission (acc. item A.6.1.6); SIL-3 (see notes)
20. Seat Type	(For trunnion-mounted) Side A: SPE / Side B: DPE; DIB-2 & DBB (notes)
21. Bore Type	Full Bore
22. Body Construction	split body, bolted
23. Cladding or Coating	Full clad - Inconel 625 weld overlay on all wetted parts
24. Valve Testing	FAT according A.9.3 and HIPPS in place test according A.9.3.7
25. Notes	Acceptance criteria for sealing tests see Annex A, DBB tests to be performed at both conditions, fully opened and closed, The manufacturer shall present all documentation in order to certify that SIL 3 requirements were achieved for the valve design, Vent and drain connections according Annex A

Valve Code	VES-2510-4-C57U
Specs	H30
1. Valve Type	Ball
2. Sealing Type	Metal to Metal
3. Valve Specification Level (VSL)	VSL-4
4. Ball Mouting	Trunnion
5. Standard	API 6D
6. Size Range (NPS)	2" - 24"
7. End Connection	ISO 27509, IX
8. Pressure Class	2500
9. Temperature	-29°C to 200°C
10. Material Class	Carbon Steel with Cladding
11. Body Material	ASTM A105 + Inconel 625 weld overlay (acc. item A.7.1.7.3)
12. Obturator Material	ASTM A105 + Inconel 625 weld overlay (acc. item A.7.1.7.3) + Tungsten carbide coating
13. Seat Material	ASTM A105 + Inconel 625 weld overlay (acc. item A.7.1.7.3) + Tungsten carbide coating
14. Seat Insert	N/A
15. Spring (Seat) Material	UNS N07750
16. Stem Material	ASTM B637 (UNS N07718)
17. Seat-Stem Seal	Group E (acc. item A.7.1.5.6)
18. Operator Type	Actuated
19. Additional Requirement	Fire Tested (acc. item A.6.1.4); Fugitive Emission (acc. item A.6.1.6)
20. Seat Type	(For trunnion-mounted) Side A: SPE / Side B: DPE; DIB-2 & DBB (notes)
21. Bore Type	Full Bore
22. Body Construction	split body, bolted
23. Cladding or Coating	Full clad - Inconel 625 weld overlay on all wetted parts
24. Valve Testing	FAT according A.9.3
25. Notes	Acceptance criteria for sealing tests see Annex A, DBB tests to be performed at both conditions, fully opened and closed, Vent and drain connections according Annex A

Valve Code	VES-2510-4-D354
Specs	H12P H12
1. Valve Type	Ball
2. Sealing Type	Metal to Metal
3. Valve Specification Level (VSL)	VSL-4
4. Ball Mouting	Trunnion
5. Standard	API 6D / IOGP S-562
6. Size Range (NPS)	4" - 24"
7. End Connection	ISO 27509, IX
8. Pressure Class	2500
9. Temperature	-30°C to 150°C
10. Material Class	Super Duplex Steel
11. Body Material	ASTM A182 Gr F55
12. Obturator Material	Super Duplex (UNS S32760) + Tungsten carbide coating
13. Seat Material	Super Duplex (UNS S32760) + Tungsten carbide coating
14. Seat Insert	N/A
15. Spring (Seat) Material	UNS N06625
16. Stem Material	ASTM A276 (UNS S32760)
17. Seat-Stem Seal	Group B (acc. item A.7.1.5.6)
18. Operator Type	Actuated
19. Additional Requirement	Fire Tested (acc. item A.6.1.4)
20. Seat Type	(For trunnion-mounted) Side A: SPE / Side B: DPE; DIB-2 & DBB (notes)
21. Bore Type	Full Bore
22. Body Construction	split body, bolted
23. Cladding or Coating	N/A
24. Valve Testing	FAT according A.9.3
25. Notes	Acceptance criteria for sealing tests see Annex A, DBB tests to be performed at both conditions, fully opened and closed, Vent and drain connections according Annex A

Valve Code	VES-2510-4-D35U
Specs	H12P H12
1. Valve Type	Ball
2. Sealing Type	Metal to Metal
3. Valve Specification Level (VSL)	VSL-4
4. Ball Mouting	Trunnion
5. Standard	API 6D / IOGP S-562
6. Size Range (NPS)	4" - 24"
7. End Connection	ISO 27509, IX
8. Pressure Class	2500
9. Temperature	-30°C to 150°C
10. Material Class	Super Duplex Steel
11. Body Material	ASTM A182 Gr F55
12. Obturator Material	Super Duplex (UNS S32760) + Tungsten carbide coating
13. Seat Material	Super Duplex (UNS S32760) + Tungsten carbide coating
14. Seat Insert	N/A
15. Spring (Seat) Material	UNS N06625
16. Stem Material	ASTM A276 (UNS S32760)
17. Seat-Stem Seal	Group B (acc. item A.7.1.5.6)
18. Operator Type	Actuated
19. Additional Requirement	Fire Tested (acc. item A.6.1.4); Fugitive Emission (acc. item A.6.1.6)
20. Seat Type	(For trunnion-mounted) Side A: SPE / Side B: DPE; DIB-2 & DBB (notes)
21. Bore Type	Full Bore
22. Body Construction	split body, bolted
23. Cladding or Coating	N/A
24. Valve Testing	FAT according A.9.3
25. Notes	Acceptance criteria for sealing tests see Annex A, DBB tests to be performed at both conditions, fully opened and closed, Vent and drain connections according Annex A

Valve Code	VES-2510-4-D374
Specs	H12P H12
1. Valve Type	Ball
2. Sealing Type	Metal to Metal
3. Valve Specification Level (VSL)	VSL-4
4. Ball Mouting	Trunnion
5. Standard	API 6D
6. Size Range (NPS)	4" - 24"
7. End Connection	ISO 27509, IX
8. Pressure Class	2500
9. Temperature	-50°C to 200°C
10. Material Class	Super Duplex Steel
11. Body Material	ASTM A182 Gr F55
12. Obturator Material	Super Duplex (UNS S32760) + Tungsten carbide coating
13. Seat Material	Super Duplex (UNS S32760) + Tungsten carbide coating
14. Seat Insert	N/A
15. Spring (Seat) Material	UNS N06625
16. Stem Material	ASTM A276 (UNS S32760)
17. Seat-Stem Seal	Group E (acc. item A.7.1.5.6)
18. Operator Type	Actuated
19. Additional Requirement	Fire Tested (acc. item A.6.1.4)
20. Seat Type	(For trunnion-mounted) Side A: SPE / Side B: DPE; DIB-2 & DBB (notes)
21. Bore Type	Full Bore
22. Body Construction	split body, bolted
23. Cladding or Coating	N/A
24. Valve Testing	FAT according A.9.3
25. Notes	Acceptance criteria for sealing tests see Annex A, DBB tests to be performed at both conditions, fully opened and closed, Vent and drain connections according Annex A

Valve Code	VES-2510-4-D375
Specs	H12
1. Valve Type	Ball
2. Sealing Type	Metal to Metal
3. Valve Specification Level (VSL)	VSL-4
4. Ball Mouting	Trunnion
5. Standard	API 6D
6. Size Range (NPS)	6" - 24"
7. End Connection	ISO 27509, IX
8. Pressure Class	2500
9. Temperature	-50°C to 200°C
10. Material Class	Super Duplex Steel
11. Body Material	ASTM A182 Gr F55
12. Obturator Material	Super Duplex (UNS S32760) + Tungsten carbide coating
13. Seat Material	Super Duplex (UNS S32760) + Tungsten carbide coating
14. Seat Insert	N/A
15. Spring (Seat) Material	UNS N06625
16. Stem Material	ASTM A276 (UNS S32760)
17. Seat-Stem Seal	Group E (acc. item A.7.1.5.6)
18. Operator Type	Actuated
19. Additional Requirement	Fire Tested (acc. item A.6.1.4), Fire Tested (acc. item A.6.1.4); SIL-3 (see notes)
20. Seat Type	(For trunnion-mounted) Side A: SPE / Side B: DPE; DIB-2 & DBB (notes)
21. Bore Type	Full Bore
22. Body Construction	split body, bolted
23. Cladding or Coating	N/A
24. Valve Testing	FAT according A.9.3 and HIPPS in place test according A.9.3.7
25. Notes	Acceptance criteria for sealing tests see Annex A, DBB tests to be performed at both conditions, fully opened and closed, The manufacturer shall present all documentation in order to certify that SIL 3 requirements were achieved for the valve design, Vent and drain connections according Annex A

Valve Code	VES-2510-4-D37E
Specs	H12P H12
1. Valve Type	Ball
2. Sealing Type	Metal to Metal
3. Valve Specification Level (VSL)	VSL-4
4. Ball Mouting	Trunnion
5. Standard	API 6D
6. Size Range (NPS)	4" - 24"
7. End Connection	ISO 27509, IX
8. Pressure Class	2500
9. Temperature	-50°C to 200°C
10. Material Class	Super Duplex Steel
11. Body Material	ASTM A182 Gr F55
12. Obturator Material	Super Duplex (UNS S32760) + Tungsten carbide coating
13. Seat Material	Super Duplex (UNS S32760) + Tungsten carbide coating
14. Seat Insert	N/A
15. Spring (Seat) Material	UNS N06625
16. Stem Material	ASTM A276 (UNS S32760)
17. Seat-Stem Seal	Group E (acc. item A.7.1.5.6)
18. Operator Type	Actuated
19. Additional Requirement	Fire Tested (acc. item A.6.1.4); Fugitive Emission (acc. item A.6.1.6); SIL-3 (see notes)
20. Seat Type	(For trunnion-mounted) Side A: SPE / Side B: DPE; DIB-2 & DBB (notes)
21. Bore Type	Full Bore
22. Body Construction	split body, bolted
23. Cladding or Coating	N/A
24. Valve Testing	FAT according A.9.3 and HIPPS in place test according A.9.3.7
25. Notes	Acceptance criteria for sealing tests see Annex A, DBB tests to be performed at both conditions, fully opened and closed, The manufacturer shall present all documentation in order to certify that SIL 3 requirements were achieved for the valve design, vent and drain connections according Annex A

Valve Code	VES-2510-4-D37U
Specs	H12P H12
1. Valve Type	Ball
2. Sealing Type	Metal to Metal
3. Valve Specification Level (VSL)	VSL-4
4. Ball Mouting	Trunnion
5. Standard	API 6D
6. Size Range (NPS)	4" - 18"
7. End Connection	ISO 27509, IX
8. Pressure Class	2500
9. Temperature	-50°C to 200°C
10. Material Class	Super Duplex Steel
11. Body Material	ASTM A182 Gr F55
12. Obturator Material	Super Duplex (UNS S32760) + Tungsten carbide coating
13. Seat Material	Super Duplex (UNS S32760) + Tungsten carbide coating
14. Seat Insert	N/A
15. Spring (Seat) Material	UNS N06625
16. Stem Material	ASTM A276 (UNS S32760)
17. Seat-Stem Seal	Group E (acc. item A.7.1.5.6)
18. Operator Type	Actuated
19. Additional Requirement	Fire Tested (acc. item A.6.1.4); Fugitive Emission (acc. item A.6.1.6)
20. Seat Type	(For trunnion-mounted) Side A: SPE / Side B: DPE; DIB-2 & DBB (notes)
21. Bore Type	Full Bore
22. Body Construction	split body, bolted
23. Cladding or Coating	N/A
24. Valve Testing	FAT according A.9.3
25. Notes	Acceptance criteria for sealing tests see Annex A, DBB tests to be performed at both conditions, fully opened and closed, Vent and drain connections according Annex A

Valve Code	VES-2510R-2-c534
Specs	H30
1. Valve Type	Ball
2. Sealing Type	Metal to Metal
3. Valve Specification Level (VSL)	VSL-4
4. Ball Mouting	Trunnion
5. Standard	API 6D
6. Size Range (NPS)	4" - 24"
7. End Connection	ISO 27509, IX
8. Pressure Class	2500
9. Temperature	-50°C to 200°C
10. Material Class	Super Duplex Steel
11. Body Material	ASTM A182 Gr F55
12. Obturator Material	Super Duplex (UNS S32760) + Tungsten carbide coating
13. Seat Material	Super Duplex (UNS S32760) + Tungsten carbide coating
14. Seat Insert	N/A
15. Spring (Seat) Material	UNS N06625
16. Stem Material	ASTM A276 (UNS S32760)
17. Seat-Stem Seal	Group E (acc. item A.7.1.5.6)
18. Operator Type	Actuated
19. Additional Requirement	Fire Tested (acc. item A.6.1.4); Fugitive Emission (acc. item A.6.1.6)
20. Seat Type	(For trunnion-mounted) Side A: SPE / Side B: DPE; DIB-2 & DBB (notes)
21. Bore Type	Full Bore
22. Body Construction	split body, bolted
23. Cladding or Coating	N/A
24. Valve Testing	FAT according A.9.3
25. Notes	Acceptance criteria for sealing tests see Annex A, DBB tests to be performed at both conditions, fully opened and closed, Vent and drain connections according Annex A



































Valve Code	VES-300-3-C536	
Specs	C30	
1. Valve Type	Ball	
2. Sealing Type	Soft	
3. Valve Specification Level (VSL)	VSL-3	
4. Ball Mouting	2" - 4" Floating	6" - 30" Trunnion
5. Standard	API 6D / IOGP S-562	
6. Size Range (NPS)	2" - 30"	
7. End Connection	RF	
8. Pressure Class	300	
9. Temperature	0°C to 150°C	
10. Material Class	Carbon Steel with Cladding	
11. Body Material	ASTM A105 + Inconel 625 weld overlay (acc. item A.7.1.7.3)	
12. Obturator Material	ASTM A105 + Inconel 625 weld overlay (acc. item A.7.1.7.3)	
13. Seat Material	ASTM A105 + Inconel 625 weld overlay (acc. item A.7.1.7.3)	
14. Seat Insert	PTFE reinforced with 25% Carbon	
15. Spring (Seat) Material	UNS N07750	
16. Stem Material	ASTM B637 (UNS N07718)	
17. Seat-Stem Seal	Group D (acc. item A.7.1.5.6)	
18. Operator Type	2" - 4" Lever	6" - 30" Gearbox
19. Additional Requirement	N/A	
20. Seat Type	(For trunnion-mounted) Side A: SPE / Side B: DPE; DIB-2 & DBB	
21. Bore Type	Full Bore	
22. Body Construction	split body, bolted	
23. Cladding or Coating	Full clad - Inconel 625 weld overlay on all wetted parts	
24. Valve Testing	FAT according A.9.3	
25. Notes	N/A	

Valve Code	VES-300-3-C537	
Specs	C30	
1. Valve Type	Ball	
2. Sealing Type	Soft	
3. Valve Specification Level (VSL)	VSL-3	
4. Ball Mouting	2" - 4" Floating	6" - 30" Trunnion
5. Standard	API 6D / IOGP S-562	
6. Size Range (NPS)	2" - 30"	
7. End Connection	RF	
8. Pressure Class	300	
9. Temperature	0°C to 150°C	
10. Material Class	Carbon Steel with Cladding	
11. Body Material	ASTM A105 + Inconel 625 weld overlay (acc. item A.7.1.7.3)	
12. Obturator Material	ASTM A105 + Inconel 625 weld overlay (acc. item A.7.1.7.3)	
13. Seat Material	ASTM A105 + Inconel 625 weld overlay (acc. item A.7.1.7.3)	
14. Seat Insert	PTFE reinforced with 25% Carbon	
15. Spring (Seat) Material	UNS N07750	
16. Stem Material	ASTM B637 (UNS N07718)	
17. Seat-Stem Seal	Group D (acc. item A.7.1.5.6)	
18. Operator Type	2" - 4" Lever	6" - 30" Gearbox
19. Additional Requirement	Fire Tested (acc. item A.6.1.4)	
20. Seat Type	(For trunnion-mounted) Side A: SPE / Side B: DPE; DIB-2 & DBB	
21. Bore Type	Full Bore	
22. Body Construction	split body, bolted	
23. Cladding or Coating	Full clad - Inconel 625 weld overlay on all wetted parts	
24. Valve Testing	FAT according A.9.3	
25. Notes	N/A	

Valve Code	VES-300-3-C53G	
Specs	C30	
1. Valve Type	Ball	
2. Sealing Type	Soft	
3. Valve Specification Level (VSL)	VSL-3	
4. Ball Mouting	2" - 4" Floating	6" - 30" Trunnion
5. Standard	API 6D / IOGP S-562	
6. Size Range (NPS)	2" - 30"	
7. End Connection	RF	
8. Pressure Class	300	
9. Temperature	0°C to 150°C	
10. Material Class	Carbon Steel with Cladding	
11. Body Material	ASTM A105 + Inconel 625 weld overlay (acc. item A.7.1.7.3)	
12. Obturator Material	ASTM A105 + Inconel 625 weld overlay (acc. item A.7.1.7.3)	
13. Seat Material	ASTM A105 + Inconel 625 weld overlay (acc. item A.7.1.7.3)	
14. Seat Insert	PTFE reinforced with 25% Carbon	
15. Spring (Seat) Material	UNS N07750	
16. Stem Material	ASTM B637 (UNS N07718)	
17. Seat-Stem Seal	Group D (acc. item A.7.1.5.6)	
18. Operator Type	2" - 4" Lever	6" - 30" Gearbox
19. Additional Requirement	Fire Tested (acc. item A.6.1.4); Fugitive Emission (acc. item A.6.1.6)	
20. Seat Type	(For trunnion-mounted) Side A: SPE / Side B: DPE; DIB-2 & DBB	
21. Bore Type	Full Bore	
22. Body Construction	split body, bolted	
23. Cladding or Coating	Full clad - Inconel 625 weld overlay on all wetted parts	
24. Valve Testing	FAT according A.9.3	
25. Notes	N/A	

Valve Code	VES-300-3-C553	
Specs	C30	
1. Valve Type	Ball	
2. Sealing Type	Metal to Metal	
3. Valve Specification Level (VSL)	VSL-3	
4. Ball Mouting	2" - 4" Floating	6" - 30" Trunnion
5. Standard	API 6D / IOGP S-562	
6. Size Range (NPS)	2" - 30"	
7. End Connection	RF	
8. Pressure Class	300	
9. Temperature	-29°C to 150°C	
10. Material Class	Carbon Steel with Cladding	
11. Body Material	ASTM A105 + Inconel 625 weld overlay (acc. item A.7.1.7.3)	
12. Obturator Material	ASTM A105 + Inconel 625 weld overlay (acc. item A.7.1.7.3) + Tungsten carbide coating	
13. Seat Material	ASTM A105 + Inconel 625 weld overlay (acc. item A.7.1.7.3) + Tungsten carbide coating	
14. Seat Insert	N/A	
15. Spring (Seat) Material	UNS N07750	
16. Stem Material	ASTM B637 (UNS N07718)	
17. Seat-Stem Seal	Group B (acc. item A.7.1.5.6)	
18. Operator Type	2" - 4" Lever	6" - 30" Gearbox
19. Additional Requirement	Fire Tested (acc. item A.6.1.4)	
20. Seat Type	(For trunnion-mounted) Side A: SPE / Side B: DPE; DIB-2 & DBB	
21. Bore Type	Full Bore	
22. Body Construction	split body, bolted	
23. Cladding or Coating	Full clad - Inconel 625 weld overlay on all wetted parts	
24. Valve Testing	FAT according A.9.3	
25. Notes	Acceptance criteria for sealing tests see Annex A	

Valve Code	VES-300-3-C55G	
Specs	C30	
1. Valve Type	Ball	
2. Sealing Type	Metal to Metal	
3. Valve Specification Level (VSL)	VSL-3	
4. Ball Mouting	2" - 4" Floating	6" - 30" Trunnion
5. Standard	API 6D / IOGP S-562	
6. Size Range (NPS)	2" - 30"	
7. End Connection	RF	
8. Pressure Class	300	
9. Temperature	-29°C to 150°C	
10. Material Class	Carbon Steel with Cladding	
11. Body Material	ASTM A105 + Inconel 625 weld overlay (acc. item A.7.1.7.3)	
12. Obturator Material	ASTM A105 + Inconel 625 weld overlay (acc. item A.7.1.7.3) + Tungsten carbide coating	
13. Seat Material	ASTM A105 + Inconel 625 weld overlay (acc. item A.7.1.7.3) + Tungsten carbide coating	
14. Seat Insert	N/A	
15. Spring (Seat) Material	UNS N07750	
16. Stem Material	ASTM B637 (UNS N07718)	
17. Seat-Stem Seal	Group B (acc. item A.7.1.5.6)	
18. Operator Type	2" - 4" Lever	6" - 30" Gearbox
19. Additional Requirement	Fire Tested (acc. item A.6.1.4); Fugitive Emission (acc. item A.6.1.6)	
20. Seat Type	(For trunnion-mounted) Side A: SPE / Side B: DPE; DIB-2 & DBB	
21. Bore Type	Full Bore	
22. Body Construction	split body, bolted	
23. Cladding or Coating	Full clad - Inconel 625 weld overlay on all wetted parts	
24. Valve Testing	FAT according A.9.3	
25. Notes	Acceptance criteria for sealing tests see Annex A	

Valve Code	VES-300-3-C562	
Specs	C30	
1. Valve Type	Ball	
2. Sealing Type	Metal to Metal	
3. Valve Specification Level (VSL)	VSL-3	
4. Ball Mouting	2" - 4" Floating	6" - 30" Trunnion
5. Standard	API 6D	
6. Size Range (NPS)	2" - 30"	
7. End Connection	RF	
8. Pressure Class	300	
9. Temperature	0°C to 210°C	
10. Material Class	Carbon Steel with Cladding	
11. Body Material	ASTM A105 + Inconel 625 weld overlay (acc. item A.7.1.7.3)	
12. Obturator Material	ASTM A105 + Inconel 625 weld overlay (acc. item A.7.1.7.3) + Tungsten carbide coating	
13. Seat Material	ASTM A105 + Inconel 625 weld overlay (acc. item A.7.1.7.3) + Tungsten carbide coating	
14. Seat Insert	N/A	
15. Spring (Seat) Material	UNS N07750	
16. Stem Material	ASTM B637 (UNS N07718)	
17. Seat-Stem Seal	Group C (acc. item A.7.1.5.6)	
18. Operator Type	2" - 4" Lever	6" - 30" Gearbox
19. Additional Requirement	N/A	
20. Seat Type	(For trunnion-mounted) Side A: SPE / Side B: DPE; DIB-2 & DBB	
21. Bore Type	Full Bore	
22. Body Construction	split body, bolted	
23. Cladding or Coating	Full clad - Inconel 625 weld overlay on all wetted parts	
24. Valve Testing	FAT according A.9.3	
25. Notes	Acceptance criteria for sealing tests see Annex A	

Valve Code	VES-300-3-C563	
Specs	C30	
1. Valve Type	Ball	
2. Sealing Type	Metal to Metal	
3. Valve Specification Level (VSL)	VSL-3	
4. Ball Mouting	2" - 4" Floating	6" - 30" Trunnion
5. Standard	API 6D	
6. Size Range (NPS)	2" - 30"	
7. End Connection	RF	
8. Pressure Class	300	
9. Temperature	0°C to 210°C	
10. Material Class	Carbon Steel with Cladding	
11. Body Material	ASTM A105 + Inconel 625 weld overlay (acc. item A.7.1.7.3)	
12. Obturator Material	ASTM A105 + Inconel 625 weld overlay (acc. item A.7.1.7.3) + Tungsten carbide coating	
13. Seat Material	ASTM A105 + Inconel 625 weld overlay (acc. item A.7.1.7.3) + Tungsten carbide coating	
14. Seat Insert	N/A	
15. Spring (Seat) Material	UNS N07750	
16. Stem Material	ASTM B637 (UNS N07718)	
17. Seat-Stem Seal	Group C (acc. item A.7.1.5.6)	
18. Operator Type	2" - 4" Lever	6" - 30" Gearbox
19. Additional Requirement	Fire Tested (acc. item A.6.1.4)	
20. Seat Type	(For trunnion-mounted) Side A: SPE / Side B: DPE; DIB-2 & DBB	
21. Bore Type	Full Bore	
22. Body Construction	split body, bolted	
23. Cladding or Coating	Full clad - Inconel 625 weld overlay on all wetted parts	
24. Valve Testing	FAT according A.9.3	
25. Notes	Acceptance criteria for sealing tests see Annex A	

Valve Code	VES-300-3-C56G	
Specs	C30	
1. Valve Type	Ball	
2. Sealing Type	Metal to Metal	
3. Valve Specification Level (VSL)	VSL-3	
4. Ball Mouting	2" - 4" Floating	6" - 30" Trunnion
5. Standard	API 6D	
6. Size Range (NPS)	2" - 30"	
7. End Connection	RF	
8. Pressure Class	300	
9. Temperature	0°C to 210°C	
10. Material Class	Carbon Steel with Cladding	
11. Body Material	ASTM A105 + Inconel 625 weld overlay (acc. item A.7.1.7.3)	
12. Obturator Material	ASTM A105 + Inconel 625 weld overlay (acc. item A.7.1.7.3) + Tungsten carbide coating	
13. Seat Material	ASTM A105 + Inconel 625 weld overlay (acc. item A.7.1.7.3) + Tungsten carbide coating	
14. Seat Insert	N/A	
15. Spring (Seat) Material	UNS N07750	
16. Stem Material	ASTM B637 (UNS N07718)	
17. Seat-Stem Seal	Group C (acc. item A.7.1.5.6)	
18. Operator Type	2" - 4" Lever	6" - 30" Gearbox
19. Additional Requirement	Fire Tested (acc. item A.6.1.4); Fugitive Emission (acc. item A.6.1.6)	
20. Seat Type	(For trunnion-mounted) Side A: SPE / Side B: DPE; DIB-2 & DBB	
21. Bore Type	Full Bore	
22. Body Construction	split body, bolted	
23. Cladding or Coating	Full clad - Inconel 625 weld overlay on all wetted parts	
24. Valve Testing	FAT according A.9.3	
25. Notes	Acceptance criteria for sealing tests see Annex A	













Valve Code	VES-600-1-C1F0
Specs	E8
1. Valve Type	Ball
2. Sealing Type	Soft
3. Valve Specification Level (VSL)	VSL-1
4. Ball Mouting	Floating
5. Standard	ISO 17292
6. Size Range (NPS)	½" - 1 ½"
7. End Connection	Flange ASME B16.5, RF
8. Pressure Class	600
9. Temperature	-29°C to 150°C
10. Material Class	Carbon Steel
11. Body Material	ASTM A105
12. Obturator Material	AISI 410
13. Seat Material	PEEK
14. Seat Insert	N/A
15. Spring (Seat) Material	N/A
16. Stem Material	ASTM A276 (UNS S41000)
17. Seat-Stem Seal	Fugitive Emission (acc. item A.9.3.6)
18. Operator Type	Lever
19. Additional Requirement	Fire Tested (acc. item A.6.1.4)
20. Seat Type	N/A
21. Bore Type	Full Bore
22. Body Construction	split body, bolted
23. Cladding or Coating	N/A
24. Valve Testing	FAT according A.9.3
25. Notes	N/A

Valve Code	VES-600-1-C214
Specs	E6 E19
1. Valve Type	Ball
2. Sealing Type	Soft
3. Valve Specification Level (VSL)	VSL-1
4. Ball Mouting	Trunnion
5. Standard	API 6D / IOGP S-562
6. Size Range (NPS)	2" - 26"
7. End Connection	RF
8. Pressure Class	600
9. Temperature	-30°C to 150°C
10. Material Class	Low-Temperature Carbon Steel
11. Body Material	ASTM A350 Gr LF2 CL1 or ASTM A352 Gr LCC + Inconel 625 weld overlay (acc. item A.7.1.7.3)
12. Obturator Material	AISI 316
13. Seat Material	AISI 316
14. Seat Insert	PEEK
15. Spring (Seat) Material	UNS N07750
16. Stem Material	ASTM A276 (UNS S31600)
17. Seat-Stem Seal	Group B (acc. item A.7.1.5.6)
18. Operator Type	2" - 3" Lever 4" - 26" Gearbox
19. Additional Requirement	N/A
20. Seat Type	(For trunnion-mounted) Side A: SPE / Side B: SPE; DBB
21. Bore Type	Full Bore
22. Body Construction	split body, bolted
23. Cladding or Coating	Partial clad - Inconel 625 weld overlay on all body sealing areas
24. Valve Testing	FAT according A.9.3
25. Notes	N/A

Valve Code	VES-600-1-C234
Specs	E6 E19
1. Valve Type	Ball
2. Sealing Type	Soft
3. Valve Specification Level (VSL)	VSL-1
4. Ball Mouting	Trunnion
5. Standard	API 6D / IOGP S-562
6. Size Range (NPS)	2" - 26"
7. End Connection	RF
8. Pressure Class	600
9. Temperature	-46°C to 150°C
10. Material Class	Low-Temperature Carbon Steel
11. Body Material	ASTM A350 Gr LF2 CL1 or ASTM A352 Gr LCC + Inconel 625 weld overlay (acc. item A.7.1.7.3)
12. Obturator Material	AISI 316
13. Seat Material	AISI 316
14. Seat Insert	PEEK
15. Spring (Seat) Material	UNS N07750
16. Stem Material	ASTM A276 (UNS S31600)
17. Seat-Stem Seal	Group E (acc. item A.7.1.5.6)
18. Operator Type	2" - 3" Lever 4" - 26" Gearbox
19. Additional Requirement	N/A
20. Seat Type	(For trunnion-mounted) Side A: SPE / Side B: SPE; DBB
21. Bore Type	Full Bore
22. Body Construction	split body, bolted
23. Cladding or Coating	Partial clad - Inconel 625 weld overlay on all body sealing areas
24. Valve Testing	FAT according A.9.3
25. Notes	N/A

Valve Code	VES-600-1-C524
Specs	E30
1. Valve Type	Ball
2. Sealing Type	Soft
3. Valve Specification Level (VSL)	VSL-1
4. Ball Mouting	Trunnion
5. Standard	API 6D / IOGP S-562
6. Size Range (NPS)	2" - 4"
7. End Connection	RF
8. Pressure Class	600
9. Temperature	0°C to 150°C
10. Material Class	Carbon Steel with Cladding
11. Body Material	ASTM A105 or ASTM A216 Gr WCB + Inconel 625 weld overlay (acc. item A.7.1.7.3)
12. Obturator Material	ASTM A105 + Inconel 625 weld overlay (acc. item A.7.1.7.3)
13. Seat Material	ASTM A105 + Inconel 625 weld overlay (acc. item A.7.1.7.3)
14. Seat Insert	PEEK
15. Spring (Seat) Material	UNS N07750
16. Stem Material	ASTM B637 (UNS N07718)
17. Seat-Stem Seal	Group C (acc. item A.7.1.5.6)
18. Operator Type	2" - 3" Lever 4" Gearbox
19. Additional Requirement	N/A
20. Seat Type	(For trunnion-mounted) Side A: SPE / Side B: SPE; DBB
21. Bore Type	Full Bore
22. Body Construction	split body, bolted
23. Cladding or Coating	Full clad - Inconel 625 weld overlay on all wetted parts
24. Valve Testing	FAT according A.9.3
25. Notes	N/A

Valve Code	VES-600-1-C534
Specs	E30
1. Valve Type	Ball
2. Sealing Type	Soft
3. Valve Specification Level (VSL)	VSL-1
4. Ball Mouting	Trunnion
5. Standard	API 6D / IOGP S-562
6. Size Range (NPS)	2" - 4"
7. End Connection	RF
8. Pressure Class	600
9. Temperature	0°C to 150°C
10. Material Class	Carbon Steel with Cladding
11. Body Material	ASTM A105 or ASTM A216 Gr WCB + Inconel 625 weld overlay (acc. item A.7.1.7.3)
12. Obturator Material	ASTM A105 + Inconel 625 weld overlay (acc. item A.7.1.7.3)
13. Seat Material	ASTM A105 + Inconel 625 weld overlay (acc. item A.7.1.7.3)
14. Seat Insert	PEEK
15. Spring (Seat) Material	UNS N07750
16. Stem Material	ASTM B637 (UNS N07718)
17. Seat-Stem Seal	Group D (acc. item A.7.1.5.6)
18. Operator Type	2" - 3" Lever 4" Gearbox
19. Additional Requirement	N/A
20. Seat Type	(For trunnion-mounted) Side A: SPE / Side B: SPE; DBB
21. Bore Type	Full Bore
22. Body Construction	split body, bolted
23. Cladding or Coating	Full clad - Inconel 625 weld overlay on all wetted parts
24. Valve Testing	FAT according A.9.3
25. Notes	N/A

Valve Code	VES-600-1-C560
Specs	E30
1. Valve Type	Ball
2. Sealing Type	Metal to Metal
3. Valve Specification Level (VSL)	VSL-1
4. Ball Mouting	Trunnion
5. Standard	API 6D
6. Size Range (NPS)	2" - 4"
7. End Connection	RF
8. Pressure Class	600
9. Temperature	0°C to 210°C
10. Material Class	Carbon Steel with Cladding
11. Body Material	ASTM A105 or ASTM A216 Gr WCB + Inconel 625 weld overlay (acc. item A.7.1.7.3)
12. Obturator Material	ASTM A105 + Inconel 625 weld overlay (acc. item A.7.1.7.3) + Tungsten carbide coating
13. Seat Material	ASTM A105 + Inconel 625 weld overlay (acc. item A.7.1.7.3) + Tungsten carbide coating
14. Seat Insert	N/A
15. Spring (Seat) Material	UNS N07750
16. Stem Material	ASTM B637 (UNS N07718)
17. Seat-Stem Seal	Group C (acc. item A.7.1.5.6)
18. Operator Type	2" - 3" Lever 4" Gearbox
19. Additional Requirement	N/A
20. Seat Type	(For trunnion-mounted) Side A: SPE / Side B: SPE
21. Bore Type	Full Bore
22. Body Construction	split body, bolted
23. Cladding or Coating	Full clad - Inconel 625 weld overlay on all wetted parts
24. Valve Testing	FAT according A.9.3
25. Notes	N/A

Valve Code	VES-600-1-C570
Specs	E30
1. Valve Type	Ball
2. Sealing Type	Metal to Metal
3. Valve Specification Level (VSL)	VSL-1
4. Ball Mouting	Trunnion
5. Standard	API 6D
6. Size Range (NPS)	2" - 4"
7. End Connection	RF
8. Pressure Class	600
9. Temperature	0°C to 210°C
10. Material Class	Carbon Steel with Cladding
11. Body Material	ASTM A105 or ASTM A216 Gr WCB + Inconel 625 weld overlay (acc. item A.7.1.7.3)
12. Obturator Material	ASTM A105 + Inconel 625 weld overlay (acc. item A.7.1.7.3) + Tungsten carbide coating
13. Seat Material	ASTM A105 + Inconel 625 weld overlay (acc. item A.7.1.7.3) + Tungsten carbide coating
14. Seat Insert	N/A
15. Spring (Seat) Material	UNS N07750
16. Stem Material	ASTM B637 (UNS N07718)
17. Seat-Stem Seal	Group D (acc. item A.7.1.5.6)
18. Operator Type	2" - 3" Lever 4" Gearbox
19. Additional Requirement	N/A
20. Seat Type	(For trunnion-mounted) Side A: SPE / Side B: SPE
21. Bore Type	Full Bore
22. Body Construction	split body, bolted
23. Cladding or Coating	Full clad - Inconel 625 weld overlay on all wetted parts
24. Valve Testing	FAT according A.9.3
25. Notes	N/A

Valve Code	VES-600-1-C580
Specs	E30
1. Valve Type	Ball
2. Sealing Type	Metal to Metal
3. Valve Specification Level (VSL)	VSL-1
4. Ball Mouting	Trunnion
5. Standard	API 6D
6. Size Range (NPS)	2" - 4"
7. End Connection	RF
8. Pressure Class	600
9. Temperature	0°C to 400°C
10. Material Class	Carbon Steel with Cladding
11. Body Material	ASTM A105 or ASTM A216 Gr WCB + Inconel 625 weld overlay (acc. item A.7.1.7.3)
12. Obturator Material	ASTM A105 + Inconel 625 weld overlay (acc. item A.7.1.7.3) + Chrome-Nickel Spray and Fuse (acc. item A.8.2.2.4)
13. Seat Material	ASTM A105 + Inconel 625 weld overlay (acc. item A.7.1.7.3) + Chrome-Nickel Spray and Fuse (acc. item A.8.2.2.4)
14. Seat Insert	N/A
15. Spring (Seat) Material	UNS N07750
16. Stem Material	ASTM B637 (UNS N07718)
17. Seat-Stem Seal	Group F (acc. item A.7.1.5.6)
18. Operator Type	2" - 3" Lever 4" Gearbox
19. Additional Requirement	N/A
20. Seat Type	(For trunnion-mounted) Side A: SPE / Side B: SPE
21. Bore Type	Full Bore
22. Body Construction	split body, bolted
23. Cladding or Coating	Full clad - Inconel 625 weld overlay on all wetted parts
24. Valve Testing	FAT according A.9.3
25. Notes	N/A

Valve Code	VES-600-1-D214
Specs	E16
1. Valve Type	Ball
2. Sealing Type	Soft
3. Valve Specification Level (VSL)	VSL-1
4. Ball Mouting	Trunnion
5. Standard	API 6D / IOGP S-562
6. Size Range (NPS)	2" - 18"
7. End Connection	RF
8. Pressure Class	600
9. Temperature	-30°C to 150°C
10. Material Class	Duplex Steel
11. Body Material	ASTM A182 Gr F51 or ASTM A995 Gr 4A
12. Obturator Material	Duplex (UNS S31803)
13. Seat Material	Duplex (UNS S31803)
14. Seat Insert	PEEK
15. Spring (Seat) Material	UNS N06625
16. Stem Material	ASTM A276 (UNS S31803)
17. Seat-Stem Seal	Group B (acc. item A.7.1.5.6)
18. Operator Type	2" - 3" Lever 4" - 18" Gearbox
19. Additional Requirement	N/A
20. Seat Type	(For trunnion-mounted) Side A: SPE / Side B: SPE; DBB
21. Bore Type	Full Bore
22. Body Construction	split body, bolted
23. Cladding or Coating	N/A
24. Valve Testing	FAT according A.9.3
25. Notes	N/A

Valve Code	VES-600-1-D224
Specs	E16
1. Valve Type	Ball
2. Sealing Type	Soft
3. Valve Specification Level (VSL)	VSL-1
4. Ball Mouting	Trunnion
5. Standard	API 6D / IOGP S-562
6. Size Range (NPS)	2" - 18"
7. End Connection	RF
8. Pressure Class	600
9. Temperature	0°C to 150°C
10. Material Class	Duplex Steel
11. Body Material	ASTM A182 Gr F51 or ASTM A995 Gr 4A
12. Obturator Material	Duplex (UNS S31803)
13. Seat Material	Duplex (UNS S31803)
14. Seat Insert	PEEK
15. Spring (Seat) Material	UNS N06625
16. Stem Material	ASTM A276 (UNS S31803)
17. Seat-Stem Seal	Group C (acc. item A.7.1.5.6)
18. Operator Type	2" - 3" Lever 4" - 18" Gearbox
19. Additional Requirement	N/A
20. Seat Type	(For trunnion-mounted) Side A: SPE / Side B: SPE; DBB
21. Bore Type	Full Bore
22. Body Construction	split body, bolted
23. Cladding or Coating	N/A
24. Valve Testing	FAT according A.9.3
25. Notes	N/A

Valve Code	VES-600-1-D234
Specs	E16
1. Valve Type	Ball
2. Sealing Type	Soft
3. Valve Specification Level (VSL)	VSL-1
4. Ball Mouting	Trunnion
5. Standard	API 6D / IOGP S-562
6. Size Range (NPS)	2" - 18"
7. End Connection	RF
8. Pressure Class	600
9. Temperature	-46°C to 150°C
10. Material Class	Duplex Steel
11. Body Material	ASTM A182 Gr F51 or ASTM A995 Gr 4A
12. Obturator Material	Duplex (UNS S31803)
13. Seat Material	Duplex (UNS S31803)
14. Seat Insert	PEEK
15. Spring (Seat) Material	UNS N06625
16. Stem Material	ASTM A276 (UNS S31803)
17. Seat-Stem Seal	Group E (acc. item A.7.1.5.6)
18. Operator Type	2" - 3" Lever 4" - 18" Gearbox
19. Additional Requirement	N/A
20. Seat Type	(For trunnion-mounted) Side A: SPE / Side B: SPE; DBB
21. Bore Type	Full Bore
22. Body Construction	split body, bolted
23. Cladding or Coating	N/A
24. Valve Testing	FAT according A.9.3
25. Notes	N/A

Valve Code	VES-600-1-S214
Specs	E3
1. Valve Type	Ball
2. Sealing Type	Soft
3. Valve Specification Level (VSL)	VSL-1
4. Ball Mouting	Trunnion
5. Standard	API 6D / IOGP S-562
6. Size Range (NPS)	2" - 32"
7. End Connection	RF
8. Pressure Class	600
9. Temperature	-30°C to 150°C
10. Material Class	Stainless Steel
11. Body Material	ASTM A182 Gr F316 or ASTM A351 Gr CF8M
12. Obturator Material	AISI 316
13. Seat Material	AISI 316
14. Seat Insert	PEEK
15. Spring (Seat) Material	UNS N07718
16. Stem Material	ASTM A276 (UNS S31600)
17. Seat-Stem Seal	Group B (acc. item A.7.1.5.6)
18. Operator Type	2" - 3" Lever 4" - 32" Gearbox
19. Additional Requirement	N/A
20. Seat Type	(For trunnion-mounted) Side A: SPE / Side B: SPE; DBB
21. Bore Type	Full Bore
22. Body Construction	split body, bolted
23. Cladding or Coating	N/A
24. Valve Testing	FAT according A.9.3
25. Notes	N/A



























Valve Code	VES-600-3-C252
Specs	E6 E19
1. Valve Type	Ball
2. Sealing Type	Metal to Metal
3. Valve Specification Level (VSL)	VSL-3
4. Ball Mouting	Trunnion
5. Standard	API 6D / IOGP S-562
6. Size Range (NPS)	2" - 26"
7. End Connection	RF
8. Pressure Class	600
9. Temperature	-30°C to 150°C
10. Material Class	Low-Temperature Carbon Steel
11. Body Material	ASTM A350 Gr LF2 CL1 + Inconel 625 weld overlay (acc. item A.7.1.7.3)
12. Obturator Material	AISI 316 + Tungsten carbide coating
13. Seat Material	AISI 316 + Tungsten carbide coating
14. Seat Insert	N/A
15. Spring (Seat) Material	UNS N07750
16. Stem Material	ASTM A276 (UNS S31600)
17. Seat-Stem Seal	Group B (acc. item A.7.1.5.6)
18. Operator Type	2" - 3" Lever 4" - 26" Gearbox
19. Additional Requirement	N/A
20. Seat Type	(For trunnion-mounted) Side A: SPE / Side B: DPE; DIB-2 & DBB
21. Bore Type	Full Bore
22. Body Construction	split body, bolted
23. Cladding or Coating	Partial clad - Inconel 625 weld overlay on all body sealing areas
24. Valve Testing	FAT according A.9.3
25. Notes	Acceptance criteria for sealing tests see Annex A

Valve Code	VES-600-3-C253
Specs	E6 E19
1. Valve Type	Ball
2. Sealing Type	Metal to Metal
3. Valve Specification Level (VSL)	VSL-3
4. Ball Mouting	Trunnion
5. Standard	API 6D / IOGP S-562
6. Size Range (NPS)	2" - 26"
7. End Connection	RF
8. Pressure Class	600
9. Temperature	-30°C to 150°C
10. Material Class	Low-Temperature Carbon Steel
11. Body Material	ASTM A350 Gr LF2 CL1 + Inconel 625 weld overlay (acc. item A.7.1.7.3)
12. Obturator Material	AISI 316 + Tungsten carbide coating
13. Seat Material	AISI 316 + Tungsten carbide coating
14. Seat Insert	N/A
15. Spring (Seat) Material	UNS N07750
16. Stem Material	ASTM A276 (UNS S31600)
17. Seat-Stem Seal	Group B (acc. item A.7.1.5.6)
18. Operator Type	2" - 3" Lever 4" - 26" Gearbox
19. Additional Requirement	Fire Tested (acc. item A.6.1.4)
20. Seat Type	(For trunnion-mounted) Side A: SPE / Side B: DPE; DIB-2 & DBB
21. Bore Type	Full Bore
22. Body Construction	split body, bolted
23. Cladding or Coating	Partial clad - Inconel 625 weld overlay on all body sealing areas
24. Valve Testing	FAT according A.9.3
25. Notes	Acceptance criteria for sealing tests see Annex A

Valve Code	VES-600-3-C256
Specs	E6 E19
1. Valve Type	Ball
2. Sealing Type	Metal to Metal
3. Valve Specification Level (VSL)	VSL-3
4. Ball Mouting	Trunnion
5. Standard	API 6D / IOGP S-562
6. Size Range (NPS)	2" - 26"
7. End Connection	RF
8. Pressure Class	600
9. Temperature	-30°C to 150°C
10. Material Class	Low-Temperature Carbon Steel
11. Body Material	ASTM A350 Gr LF2 CL1 + Inconel 625 weld overlay (acc. item A.7.1.7.3)
12. Obturator Material	AISI 316 + Tungsten carbide coating
13. Seat Material	AISI 316 + Tungsten carbide coating
14. Seat Insert	N/A
15. Spring (Seat) Material	UNS N07750
16. Stem Material	ASTM A276 (UNS S31600)
17. Seat-Stem Seal	Group B (acc. item A.7.1.5.6)
18. Operator Type	2" - 3" Lever 4" - 26" Gearbox
19. Additional Requirement	Fire Tested (acc. item A.6.1.4); Fugitive Emission (acc. item A.6.1.6)
20. Seat Type	(For trunnion-mounted) Side A: SPE / Side B: DPE; DIB-2 & DBB
21. Bore Type	Full Bore
22. Body Construction	split body, bolted
23. Cladding or Coating	Partial clad - Inconel 625 weld overlay on all body sealing areas
24. Valve Testing	FAT according A.9.3
25. Notes	Acceptance criteria for sealing tests see Annex A

Valve Code	VES-600-3-C272
Specs	E6 E19
1. Valve Type	Ball
2. Sealing Type	Metal to Metal
3. Valve Specification Level (VSL)	VSL-3
4. Ball Mouting	Trunnion
5. Standard	API 6D / IOGP S-562
6. Size Range (NPS)	2" - 26"
7. End Connection	RF
8. Pressure Class	600
9. Temperature	-30°C to 150°C
10. Material Class	Low-Temperature Carbon Steel
11. Body Material	ASTM A350 Gr LF2 CL1 + Inconel 625 weld overlay (acc. item A.7.1.7.3)
12. Obturator Material	AISI 316 + Tungsten carbide coating
13. Seat Material	AISI 316 + Tungsten carbide coating
14. Seat Insert	N/A
15. Spring (Seat) Material	UNS N07750
16. Stem Material	ASTM A276 (UNS S31600)
17. Seat-Stem Seal	Group E (acc. item A.7.1.5.6)
18. Operator Type	2" - 3" Lever 4" - 26" Gearbox
19. Additional Requirement	N/A
20. Seat Type	(For trunnion-mounted) Side A: SPE / Side B: DPE; DIB-2 & DBB
21. Bore Type	Full Bore
22. Body Construction	split body, bolted
23. Cladding or Coating	Partial clad - Inconel 625 weld overlay on all body sealing areas
24. Valve Testing	FAT according A.9.3
25. Notes	Acceptance criteria for sealing tests see Annex A

Valve Code	VES-600-3-C273
Specs	E6 E19
1. Valve Type	Ball
2. Sealing Type	Metal to Metal
3. Valve Specification Level (VSL)	VSL-3
4. Ball Mouting	Trunnion
5. Standard	API 6D
6. Size Range (NPS)	2" - 26"
7. End Connection	RF
8. Pressure Class	600
9. Temperature	-46°C to 200°C
10. Material Class	Low-Temperature Carbon Steel
11. Body Material	ASTM A350 Gr LF2 CL1 + Inconel 625 weld overlay (acc. item A.7.1.7.3)
12. Obturator Material	AISI 316 + Tungsten carbide coating
13. Seat Material	AISI 316 + Tungsten carbide coating
14. Seat Insert	N/A
15. Spring (Seat) Material	UNS N07750
16. Stem Material	ASTM A276 (UNS S31600)
17. Seat-Stem Seal	Group E (acc. item A.7.1.5.6)
18. Operator Type	2" - 3" Lever 4" - 26" Gearbox
19. Additional Requirement	Fire Tested (acc. item A.6.1.4)
20. Seat Type	(For trunnion-mounted) Side A: SPE / Side B: DPE; DIB-2 & DBB
21. Bore Type	Full Bore
22. Body Construction	split body, bolted
23. Cladding or Coating	Partial clad - Inconel 625 weld overlay on all body sealing areas
24. Valve Testing	FAT according A.9.3
25. Notes	Acceptance criteria for sealing tests see Annex A

Valve Code	VES-600-3-C276
Specs	E6 E19
1. Valve Type	Ball
2. Sealing Type	Metal to Metal
3. Valve Specification Level (VSL)	VSL-3
4. Ball Mouting	Trunnion
5. Standard	API 6D
6. Size Range (NPS)	2" - 26"
7. End Connection	RF
8. Pressure Class	600
9. Temperature	-46°C to 200°C
10. Material Class	Low-Temperature Carbon Steel
11. Body Material	ASTM A350 Gr LF2 CL1 + Inconel 625 weld overlay (acc. item A.7.1.7.3)
12. Obturator Material	AISI 316 + Tungsten carbide coating
13. Seat Material	AISI 316 + Tungsten carbide coating
14. Seat Insert	N/A
15. Spring (Seat) Material	UNS N07750
16. Stem Material	ASTM A276 (UNS S31600)
17. Seat-Stem Seal	Group E (acc. item A.7.1.5.6)
18. Operator Type	2" - 3" Lever 4" - 26" Gearbox
19. Additional Requirement	Fire Tested (acc. item A.6.1.4); Fugitive Emission (acc. item A.6.1.6)
20. Seat Type	(For trunnion-mounted) Side A: SPE / Side B: DPE; DIB-2 & DBB
21. Bore Type	Full Bore
22. Body Construction	split body, bolted
23. Cladding or Coating	Partial clad - Inconel 625 weld overlay on all body sealing areas
24. Valve Testing	FAT according A.9.3
25. Notes	Acceptance criteria for sealing tests see Annex A

Valve Code	VES-600-3-C286
Specs	E19
1. Valve Type	Ball
2. Sealing Type	Metal to Metal
3. Valve Specification Level (VSL)	VSL-3
4. Ball Mouting	Trunnion
5. Standard	API 6D
6. Size Range (NPS)	2" - 24"
7. End Connection	RF
8. Pressure Class	600
9. Temperature	-46°C to 400°C
10. Material Class	Low-Temperature Carbon Steel
11. Body Material	ASTM A350 Gr LF2 CL1 + Inconel 625 weld overlay (acc. item A.7.1.7.3)
12. Obturator Material	AISI 316 + Chrome-Nickel Spray and Fuse (acc. item A.8.2.2.4)
13. Seat Material	AISI 316 + Chrome-Nickel Spray and Fuse (acc. item A.8.2.2.4)
14. Seat Insert	N/A
15. Spring (Seat) Material	UNS N07750
16. Stem Material	ASTM A276 (UNS S31600)
17. Seat-Stem Seal	Group F (acc. item A.7.1.5.6)
18. Operator Type	2" - 3" Lever 4" - 24" Gearbox
19. Additional Requirement	Fire Tested (acc. item A.6.1.4); Fugitive Emission (acc. item A.6.1.6)
20. Seat Type	(For trunnion-mounted) Side A: SPE / Side B: DPE; DIB-2 & DBB
21. Bore Type	Full Bore
22. Body Construction	split body, bolted
23. Cladding or Coating	Partial clad - Inconel 625 weld overlay on all body sealing areas
24. Valve Testing	FAT according A.9.3
25. Notes	N/A

Valve Code	VES-600-3-C553
Specs	E30
1. Valve Type	Ball
2. Sealing Type	Metal to Metal
3. Valve Specification Level (VSL)	VSL-3
4. Ball Mouting	Trunnion
5. Standard	API 6D / IOGP S-562
6. Size Range (NPS)	2" - 24"
7. End Connection	RF
8. Pressure Class	600
9. Temperature	-29°C to 150°C
10. Material Class	Carbon Steel with Cladding
11. Body Material	ASTM A105 + Inconel 625 weld overlay (acc. item A.7.1.7.3)
12. Obturator Material	ASTM A105 + Inconel 625 weld overlay (acc. item A.7.1.7.3) + Tungsten carbide coating
13. Seat Material	ASTM A105 + Inconel 625 weld overlay (acc. item A.7.1.7.3) + Tungsten carbide coating
14. Seat Insert	N/A
15. Spring (Seat) Material	UNS N07750
16. Stem Material	ASTM B637 (UNS N07718)
17. Seat-Stem Seal	Group B (acc. item A.7.1.5.6)
18. Operator Type	2" - 3" Lever 4" - 24" Gearbox
19. Additional Requirement	Fire Tested (acc. item A.6.1.4)
20. Seat Type	(For trunnion-mounted) Side A: SPE / Side B: DPE; DIB-2 & DBB
21. Bore Type	Full Bore
22. Body Construction	split body, bolted
23. Cladding or Coating	Full clad - Inconel 625 weld overlay on all wetted parts
24. Valve Testing	FAT according A.9.3
25. Notes	Acceptance criteria for sealing tests see Annex A



Valve Code	VES-600-3-C55G
Specs	E30
1. Valve Type	Ball
2. Sealing Type	Metal to Metal
3. Valve Specification Level (VSL)	VSL-3
4. Ball Mouting	Trunnion
5. Standard	API 6D / IOGP S-562
6. Size Range (NPS)	2" - 24"
7. End Connection	RF
8. Pressure Class	600
9. Temperature	-29°C to 150°C
10. Material Class	Carbon Steel with Cladding
11. Body Material	ASTM A105 + Inconel 625 weld overlay (acc. item A.7.1.7.3)
12. Obturator Material	ASTM A105 + Inconel 625 weld overlay (acc. item A.7.1.7.3) + Tungsten carbide coating
13. Seat Material	ASTM A105 + Inconel 625 weld overlay (acc. item A.7.1.7.3) + Tungsten carbide coating
14. Seat Insert	N/A
15. Spring (Seat) Material	UNS N07750
16. Stem Material	ASTM B637 (UNS N07718)
17. Seat-Stem Seal	Group B (acc. item A.7.1.5.6)
18. Operator Type	2" - 3" Lever 4" - 24" Gearbox
19. Additional Requirement	Fire Tested (acc. item A.6.1.4); Fugitive Emission (acc. item A.6.1.6)
20. Seat Type	(For trunnion-mounted) Side A: SPE / Side B: DPE; DIB-2 & DBB
21. Bore Type	Full Bore
22. Body Construction	split body, bolted
23. Cladding or Coating	Full clad - Inconel 625 weld overlay on all wetted parts
24. Valve Testing	FAT according A.9.3
25. Notes	Acceptance criteria for sealing tests see Annex A

Valve Code	VES-600-3-C562
Specs	E30
1. Valve Type	Ball
2. Sealing Type	Metal to Metal
3. Valve Specification Level (VSL)	VSL-3
4. Ball Mouting	Trunnion
5. Standard	API 6D
6. Size Range (NPS)	2" - 24"
7. End Connection	RF
8. Pressure Class	600
9. Temperature	0°C to 210°C
10. Material Class	Carbon Steel with Cladding
11. Body Material	ASTM A105 + Inconel 625 weld overlay (acc. item A.7.1.7.3)
12. Obturator Material	ASTM A105 + Inconel 625 weld overlay (acc. item A.7.1.7.3) + Tungsten carbide coating
13. Seat Material	ASTM A105 + Inconel 625 weld overlay (acc. item A.7.1.7.3) + Tungsten carbide coating
14. Seat Insert	N/A
15. Spring (Seat) Material	UNS N07750
16. Stem Material	ASTM B637 (UNS N07718)
17. Seat-Stem Seal	Group C (acc. item A.7.1.5.6)
18. Operator Type	2" - 3" Lever 4" - 24" Gearbox
19. Additional Requirement	N/A
20. Seat Type	(For trunnion-mounted) Side A: SPE / Side B: DPE; DIB-2 & DBB
21. Bore Type	Full Bore
22. Body Construction	split body, bolted
23. Cladding or Coating	Full clad - Inconel 625 weld overlay on all wetted parts
24. Valve Testing	FAT according A.9.3
25. Notes	Acceptance criteria for sealing tests see Annex A

Valve Code	VES-600-3-C563
Specs	E30
1. Valve Type	Ball
2. Sealing Type	Metal to Metal
3. Valve Specification Level (VSL)	VSL-3
4. Ball Mouting	Trunnion
5. Standard	API 6D
6. Size Range (NPS)	2" - 24"
7. End Connection	RF
8. Pressure Class	600
9. Temperature	0°C to 210°C
10. Material Class	Carbon Steel with Cladding
11. Body Material	ASTM A105 + Inconel 625 weld overlay (acc. item A.7.1.7.3)
12. Obturator Material	ASTM A105 + Inconel 625 weld overlay (acc. item A.7.1.7.3) + Tungsten carbide coating
13. Seat Material	ASTM A105 + Inconel 625 weld overlay (acc. item A.7.1.7.3) + Tungsten carbide coating
14. Seat Insert	N/A
15. Spring (Seat) Material	UNS N07750
16. Stem Material	ASTM B637 (UNS N07718)
17. Seat-Stem Seal	Group C (acc. item A.7.1.5.6)
18. Operator Type	2" - 3" Lever 4" - 24" Gearbox
19. Additional Requirement	Fire Tested (acc. item A.6.1.4)
20. Seat Type	(For trunnion-mounted) Side A: SPE / Side B: DPE; DIB-2 & DBB
21. Bore Type	Full Bore
22. Body Construction	split body, bolted
23. Cladding or Coating	Full clad - Inconel 625 weld overlay on all wetted parts
24. Valve Testing	FAT according A.9.3
25. Notes	Acceptance criteria for sealing tests see Annex A

Valve Code	VES-600-3-C572
Specs	E30
1. Valve Type	Ball
2. Sealing Type	Metal to Metal
3. Valve Specification Level (VSL)	VSL-3
4. Ball Mouting	Trunnion
5. Standard	API 6D
6. Size Range (NPS)	2" - 24"
7. End Connection	RF
8. Pressure Class	600
9. Temperature	-29°C to 200°C
10. Material Class	Carbon Steel with Cladding
11. Body Material	ASTM A105 + Inconel 625 weld overlay (acc. item A.7.1.7.3)
12. Obturator Material	ASTM A105 + Inconel 625 weld overlay (acc. item A.7.1.7.3) + Tungsten carbide coating
13. Seat Material	ASTM A105 + Inconel 625 weld overlay (acc. item A.7.1.7.3) + Tungsten carbide coating
14. Seat Insert	N/A
15. Spring (Seat) Material	UNS N07750
16. Stem Material	ASTM B637 (UNS N07718)
17. Seat-Stem Seal	Group E (acc. item A.7.1.5.6)
18. Operator Type	2" - 3" Lever 4" - 24" Gearbox
19. Additional Requirement	N/A
20. Seat Type	(For trunnion-mounted) Side A: SPE / Side B: DPE; DIB-2 & DBB
21. Bore Type	Full Bore
22. Body Construction	split body, bolted
23. Cladding or Coating	Full clad - Inconel 625 weld overlay on all wetted parts
24. Valve Testing	FAT according A.9.3
25. Notes	Acceptance criteria for sealing tests see Annex A

Valve Code	VES-600-3-C573
Specs	E30
1. Valve Type	Ball
2. Sealing Type	Metal to Metal
3. Valve Specification Level (VSL)	VSL-3
4. Ball Mouting	Trunnion
5. Standard	API 6D
6. Size Range (NPS)	2" - 24"
7. End Connection	RF
8. Pressure Class	600
9. Temperature	-29°C to 200°C
10. Material Class	Carbon Steel with Cladding
11. Body Material	ASTM A105 + Inconel 625 weld overlay (acc. item A.7.1.7.3)
12. Obturator Material	ASTM A105 + Inconel 625 weld overlay (acc. item A.7.1.7.3) + Tungsten carbide coating
13. Seat Material	ASTM A105 + Inconel 625 weld overlay (acc. item A.7.1.7.3) + Tungsten carbide coating
14. Seat Insert	N/A
15. Spring (Seat) Material	UNS N07750
16. Stem Material	ASTM B637 (UNS N07718)
17. Seat-Stem Seal	Group E (acc. item A.7.1.5.6)
18. Operator Type	2" - 3" Lever 4" - 24" Gearbox
19. Additional Requirement	Fire Tested (acc. item A.6.1.4)
20. Seat Type	(For trunnion-mounted) Side A: SPE / Side B: DPE; DIB-2 & DBB
21. Bore Type	Full Bore
22. Body Construction	split body, bolted
23. Cladding or Coating	Full clad - Inconel 625 weld overlay on all wetted parts
24. Valve Testing	FAT according A.9.3
25. Notes	Acceptance criteria for sealing tests see Annex A

Valve Code	VES-600-3-C57G
Specs	E30
1. Valve Type	Ball
2. Sealing Type	Metal to Metal
3. Valve Specification Level (VSL)	VSL-3
4. Ball Mouting	Trunnion
5. Standard	API 6D
6. Size Range (NPS)	2" - 24"
7. End Connection	RF
8. Pressure Class	600
9. Temperature	-29°C to 200°C
10. Material Class	Carbon Steel with Cladding
11. Body Material	ASTM A105 + Inconel 625 weld overlay (acc. item A.7.1.7.3)
12. Obturator Material	ASTM A105 + Inconel 625 weld overlay (acc. item A.7.1.7.3) + Tungsten carbide coating
13. Seat Material	ASTM A105 + Inconel 625 weld overlay (acc. item A.7.1.7.3) + Tungsten carbide coating
14. Seat Insert	N/A
15. Spring (Seat) Material	UNS N07750
16. Stem Material	ASTM B637 (UNS N07718)
17. Seat-Stem Seal	Group E (acc. item A.7.1.5.6)
18. Operator Type	2" - 3" Lever 4" - 24" Gearbox
19. Additional Requirement	Fire Tested (acc. item A.6.1.4); Fugitive Emission (acc. item A.6.1.6)
20. Seat Type	(For trunnion-mounted) Side A: SPE / Side B: DPE; DIB-2 & DBB
21. Bore Type	Full Bore
22. Body Construction	split body, bolted
23. Cladding or Coating	Full clad - Inconel 625 weld overlay on all wetted parts
24. Valve Testing	FAT according A.9.3
25. Notes	Acceptance criteria for sealing tests see Annex A

Valve Code	VES-600-3-C582
Specs	E30
1. Valve Type	Ball
2. Sealing Type	Metal to Metal
3. Valve Specification Level (VSL)	VSL-3
4. Ball Mouting	Trunnion
5. Standard	API 6D
6. Size Range (NPS)	2" - 20"
7. End Connection	RF
8. Pressure Class	600
9. Temperature	0°C to 400°C
10. Material Class	Carbon Steel with Cladding
11. Body Material	ASTM A105 + Inconel 625 weld overlay (acc. item A.7.1.7.3)
12. Obturator Material	ASTM A105 + Inconel 625 weld overlay (acc. item A.7.1.7.3) + Chrome-Nickel Spray and Fuse (acc. item A.8.2.2.4)
13. Seat Material	ASTM A105 + Inconel 625 weld overlay (acc. item A.7.1.7.3) + Chrome-Nickel Spray and Fuse (acc. item A.8.2.2.4)
14. Seat Insert	N/A
15. Spring (Seat) Material	UNS N07750
16. Stem Material	ASTM B637 (UNS N07718)
17. Seat-Stem Seal	Group F (acc. item A.7.1.5.6)
18. Operator Type	2" - 3" Lever 4" - 20" Gearbox
19. Additional Requirement	N/A
20. Seat Type	(For trunnion-mounted) Side A: SPE / Side B: DPE; DIB-2 & DBB
21. Bore Type	Full Bore
22. Body Construction	split body, bolted
23. Cladding or Coating	Full clad - Inconel 625 weld overlay on all wetted parts
24. Valve Testing	FAT according A.9.3
25. Notes	Acceptance criteria for sealing tests see Annex A

Valve Code	VES-600-3-C583
Specs	E30
1. Valve Type	Ball
2. Sealing Type	Metal to Metal
3. Valve Specification Level (VSL)	VSL-3
4. Ball Mouting	Trunnion
5. Standard	API 6D
6. Size Range (NPS)	2" - 24"
7. End Connection	RF
8. Pressure Class	600
9. Temperature	0°C to 400°C
10. Material Class	Carbon Steel with Cladding
11. Body Material	ASTM A105 + Inconel 625 weld overlay (acc. item A.7.1.7.3)
12. Obturator Material	ASTM A105 + Inconel 625 weld overlay (acc. item A.7.1.7.3) + Chrome-Nickel Spray and Fuse (acc. item A.8.2.2.4)
13. Seat Material	ASTM A105 + Inconel 625 weld overlay (acc. item A.7.1.7.3) + Chrome-Nickel Spray and Fuse (acc. item A.8.2.2.4)
14. Seat Insert	N/A
15. Spring (Seat) Material	UNS N07750
16. Stem Material	ASTM B637 (UNS N07718)
17. Seat-Stem Seal	Group F (acc. item A.7.1.5.6)
18. Operator Type	2" - 3" Lever 4" - 24" Gearbox
19. Additional Requirement	Fire Tested (acc. item A.6.1.4)
20. Seat Type	(For trunnion-mounted) Side A: SPE / Side B: DPE; DIB-2 & DBB
21. Bore Type	Full Bore
22. Body Construction	split body, bolted
23. Cladding or Coating	Full clad - Inconel 625 weld overlay on all wetted parts
24. Valve Testing	FAT according A.9.3
25. Notes	Acceptance criteria for sealing tests see Annex A









Valve Code	VES-600-4-C254
Specs	E6 E19
1. Valve Type	Ball
2. Sealing Type	Metal to Metal
3. Valve Specification Level (VSL)	VSL-4
4. Ball Mouting	Trunnion
5. Standard	API 6D / IOGP S-562
6. Size Range (NPS)	6" - 26"
7. End Connection	RF
8. Pressure Class	600
9. Temperature	-30°C to 150°C
10. Material Class	Low-Temperature Carbon Steel
11. Body Material	ASTM A350 Gr LF2 CL1 + Inconel 625 weld overlay (acc. item A.7.1.7.3)
12. Obturator Material	AISI 316 + Tungsten carbide coating
13. Seat Material	AISI 316 + Tungsten carbide coating
14. Seat Insert	N/A
15. Spring (Seat) Material	UNS N07750
16. Stem Material	ASTM A276 (UNS S31600)
17. Seat-Stem Seal	Group B (acc. item A.7.1.5.6)
18. Operator Type	Actuated
19. Additional Requirement	Fire Tested (acc. item A.6.1.4)
20. Seat Type	(For trunnion-mounted) Side A: SPE / Side B: DPE; DIB-2 & DBB (notes)
21. Bore Type	Full Bore
22. Body Construction	split body, bolted
23. Cladding or Coating	Partial clad - Inconel 625 weld overlay on all body sealing areas
24. Valve Testing	FAT according A.9.3
25. Notes	Acceptance criteria for sealing tests see Annex A, DBB tests to be performed at both conditions, fully opened and closed, Vent and drain connections according Annex A

Valve Code	VES-600-4-C274
Specs	E6 E19
1. Valve Type	Ball
2. Sealing Type	Metal to Metal
3. Valve Specification Level (VSL)	VSL-4
4. Ball Mouting	Trunnion
5. Standard	API 6D
6. Size Range (NPS)	6" - 26"
7. End Connection	RF
8. Pressure Class	600
9. Temperature	-46°C to 200°C
10. Material Class	Low-Temperature Carbon Steel
11. Body Material	ASTM A350 Gr LF2 CL1 + Inconel 625 weld overlay (acc. item A.7.1.7.3)
12. Obturator Material	AISI 316 + Tungsten carbide coating
13. Seat Material	AISI 316 + Tungsten carbide coating
14. Seat Insert	N/A
15. Spring (Seat) Material	UNS N07750
16. Stem Material	ASTM A276 (UNS S31600)
17. Seat-Stem Seal	Group E (acc. item A.7.1.5.6)
18. Operator Type	Actuated
19. Additional Requirement	Fire Tested (acc. item A.6.1.4)
20. Seat Type	(For trunnion-mounted) Side A: SPE / Side B: DPE; DIB-2 & DBB (notes)
21. Bore Type	Full Bore
22. Body Construction	split body, bolted
23. Cladding or Coating	Partial clad - Inconel 625 weld overlay on all body sealing areas
24. Valve Testing	FAT according A.9.3
25. Notes	Acceptance criteria for sealing tests see Annex A, DBB tests to be performed at both conditions, fully opened and closed, Vent and drain connections according Annex A

Valve Code	VES-600-4-C564
Specs	E30
1. Valve Type	Ball
2. Sealing Type	Metal to Metal
3. Valve Specification Level (VSL)	VSL-4
4. Ball Mouting	Trunnion
5. Standard	API 6D
6. Size Range (NPS)	4" - 24"
7. End Connection	RF
8. Pressure Class	600
9. Temperature	0°C to 210°C
10. Material Class	Carbon Steel with Cladding
11. Body Material	ASTM A105 + Inconel 625 weld overlay (acc. item A.7.1.7.3)
12. Obturator Material	ASTM A105 + Inconel 625 weld overlay (acc. item A.7.1.7.3) + Tungsten carbide coating
13. Seat Material	ASTM A105 + Inconel 625 weld overlay (acc. item A.7.1.7.3) + Tungsten carbide coating
14. Seat Insert	N/A
15. Spring (Seat) Material	UNS N07750
16. Stem Material	ASTM B637 (UNS N07718)
17. Seat-Stem Seal	Group C (acc. item A.7.1.5.6)
18. Operator Type	Actuated
19. Additional Requirement	Fire Tested (acc. item A.6.1.4)
20. Seat Type	(For trunnion-mounted) Side A: SPE / Side B: DPE; DIB-2 & DBB (notes)
21. Bore Type	Full Bore
22. Body Construction	split body, bolted
23. Cladding or Coating	Full clad - Inconel 625 weld overlay on all wetted parts
24. Valve Testing	FAT according A.9.3
25. Notes	Acceptance criteria for sealing tests see Annex A, DBB tests to be performed at both conditions, fully opened and closed, Vent and drain connections according Annex A

Valve Code	VES-600-4-C574
Specs	E30
1. Valve Type	Ball
2. Sealing Type	Metal to Metal
3. Valve Specification Level (VSL)	VSL-4
4. Ball Mouting	Trunnion
5. Standard	API 6D
6. Size Range (NPS)	6" - 24"
7. End Connection	RF
8. Pressure Class	600
9. Temperature	0°C to 210°C
10. Material Class	Carbon Steel with Cladding
11. Body Material	ASTM A105 + Inconel 625 weld overlay (acc. item A.7.1.7.3)
12. Obturator Material	ASTM A105 + Inconel 625 weld overlay (acc. item A.7.1.7.3) + Tungsten carbide coating
13. Seat Material	ASTM A105 + Inconel 625 weld overlay (acc. item A.7.1.7.3) + Tungsten carbide coating
14. Seat Insert	N/A
15. Spring (Seat) Material	UNS N07750
16. Stem Material	ASTM B637 (UNS N07718)
17. Seat-Stem Seal	Group D (acc. item A.7.1.5.6)
18. Operator Type	Actuated
19. Additional Requirement	Fire Tested (acc. item A.6.1.4)
20. Seat Type	(For trunnion-mounted) Side A: SPE / Side B: DPE; DIB-2 & DBB (notes)
21. Bore Type	Full Bore
22. Body Construction	split body, bolted
23. Cladding or Coating	Full clad - Inconel 625 weld overlay on all wetted parts
24. Valve Testing	FAT according A.9.3
25. Notes	Acceptance criteria for sealing tests see Annex A, DBB tests to be performed at both conditions, fully opened and closed, Vent and drain connections according Annex A

Valve Code	VES-600-4-C584
Specs	E30
1. Valve Type	Ball
2. Sealing Type	Metal to Metal
3. Valve Specification Level (VSL)	VSL-4
4. Ball Mouting	Trunnion
5. Standard	API 6D
6. Size Range (NPS)	6" - 24"
7. End Connection	RF
8. Pressure Class	600
9. Temperature	0°C to 400°C
10. Material Class	Carbon Steel with Cladding
11. Body Material	ASTM A105 + Inconel 625 weld overlay (acc. item A.7.1.7.3)
12. Obturator Material	ASTM A105 + Inconel 625 weld overlay (acc. item A.7.1.7.3) + Chrome-Nickel Spray and Fuse (acc. item A.8.2.2.4)
13. Seat Material	ASTM A105 + Inconel 625 weld overlay (acc. item A.7.1.7.3) + Chrome-Nickel Spray and Fuse (acc. item A.8.2.2.4)
14. Seat Insert	N/A
15. Spring (Seat) Material	UNS N07750
16. Stem Material	ASTM B637 (UNS N07718)
17. Seat-Stem Seal	Group F (acc. item A.7.1.5.6)
18. Operator Type	Actuated
19. Additional Requirement	Fire Tested (acc. item A.6.1.4)
20. Seat Type	(For trunnion-mounted) Side A: SPE / Side B: DPE; DIB-2 & DBB (notes)
21. Bore Type	Full Bore
22. Body Construction	split body, bolted
23. Cladding or Coating	Full clad - Inconel 625 weld overlay on all wetted parts
24. Valve Testing	FAT according A.9.3
25. Notes	Acceptance criteria for sealing tests see Annex A, DBB tests to be performed at both conditions, fully opened and closed, Vent and drain connections according Annex A

Valve Code	VES-801-1-D201
Specs	B16 C16
1. Valve Type	Ball
2. Sealing Type	Soft
3. Valve Specification Level (VSL)	VSL-1
4. Ball Mouting	Floating
5. Standard	ISO 17292
6. Size Range (NPS)	½" - 1 ½"
7. End Connection	socket weld ends ASME B16.11 with nipple SCH 40S
8. Pressure Class	800
9. Temperature	-30°C to 150°C
10. Material Class	Duplex Steel
11. Body Material	ASTM A182 Gr F51
12. Obturator Material	Duplex (UNS S31803)
13. Seat Material	PTFE reinforced with 25% Carbon
14. Seat Insert	N/A
15. Spring (Seat) Material	N/A
16. Stem Material	ASTM A276 (UNS S31803)
17. Seat-Stem Seal	Group B (acc. item A.7.1.5.6)
18. Operator Type	Lever
19. Additional Requirement	Fire Tested (acc. item A.6.1.4)
20. Seat Type	N/A
21. Bore Type	Full Bore
22. Body Construction	split body, bolted
23. Cladding or Coating	N/A
24. Valve Testing	FAT according A.9.3
25. Notes	N/A

Valve Code	VES-801-1-D202
Specs	B16 C16
1. Valve Type	Ball
2. Sealing Type	Soft
3. Valve Specification Level (VSL)	VSL-1
4. Ball Mouting	Floating
5. Standard	ISO 17292
6. Size Range (NPS)	½" - 1 ½"
7. End Connection	socket weld ends ASME B16.11 with nipple SCH 40S
8. Pressure Class	800
9. Temperature	-46°C to 150°C
10. Material Class	Duplex Steel
11. Body Material	ASTM A182 Gr F51
12. Obturator Material	Duplex (UNS S31803)
13. Seat Material	PTFE reinforced with 25% Carbon
14. Seat Insert	N/A
15. Spring (Seat) Material	N/A
16. Stem Material	ASTM A276 (UNS S31803)
17. Seat-Stem Seal	Group E (acc. item A.7.1.5.6)
18. Operator Type	Lever
19. Additional Requirement	Fire Tested (acc. item A.6.1.4)
20. Seat Type	N/A
21. Bore Type	Full Bore
22. Body Construction	split body, bolted
23. Cladding or Coating	N/A
24. Valve Testing	FAT according A.9.3
25. Notes	N/A

Valve Code	VES-801-1-D203
Specs	E16
1. Valve Type	Ball
2. Sealing Type	Soft
3. Valve Specification Level (VSL)	VSL-1
4. Ball Mouting	Floating
5. Standard	ISO 17292
6. Size Range (NPS)	½" - 1 ½"
7. End Connection	socket weld ends ASME B16.11 with nipple SCH 40S
8. Pressure Class	800
9. Temperature	-30°C to 150°C
10. Material Class	Duplex Steel
11. Body Material	ASTM A182 Gr F51
12. Obturator Material	Duplex (UNS S31803)
13. Seat Material	PEEK
14. Seat Insert	N/A
15. Spring (Seat) Material	N/A
16. Stem Material	ASTM A276 (UNS S31803)
17. Seat-Stem Seal	Group B (acc. item A.7.1.5.6)
18. Operator Type	Lever
19. Additional Requirement	Fire Tested (acc. item A.6.1.4)
20. Seat Type	N/A
21. Bore Type	Full Bore
22. Body Construction	split body, bolted
23. Cladding or Coating	N/A
24. Valve Testing	FAT according A.9.3
25. Notes	N/A























Valve Code	VES-803-3-C105
Specs	B9 B10 C10 E34
1. Valve Type	Ball
2. Sealing Type	Metal to Metal
3. Valve Specification Level (VSL)	VSL-3
4. Ball Mouting	Floating
5. Standard	ISO 17292
6. Size Range (NPS)	½" - 1 ½"
7. End Connection	socket weld ends ASME B16.11 with nipple SCH 160
8. Pressure Class	800
9. Temperature	-29°C to 210°C
10. Material Class	Carbon Steel
11. Body Material	ASTM A105
12. Obturator Material	AISI 410 + Hard Coating (acc. Item A.7.1.7.4)
13. Seat Material	AISI 410 + Hard Coating (acc. Item A.7.1.7.4)
14. Seat Insert	N/A
15. Spring (Seat) Material	N/A
16. Stem Material	ASTM A276 (UNS S41000)
17. Seat-Stem Seal	Group D (acc. item A.7.1.5.6)
18. Operator Type	Lever
19. Additional Requirement	Fire Tested (acc. item A.6.1.4)
20. Seat Type	N/A
21. Bore Type	Full Bore
22. Body Construction	split body, bolted
23. Cladding or Coating	N/A
24. Valve Testing	FAT according A.9.3
25. Notes	N/A

Valve Code	VES-803-3-C1F5
Specs	B9 B10 C10 E34
1. Valve Type	Ball
2. Sealing Type	Metal to Metal
3. Valve Specification Level (VSL)	VSL-3
4. Ball Mouting	Floating
5. Standard	ISO 17292
6. Size Range (NPS)	½" - 1 ½"
7. End Connection	socket weld ends ASME B16.11 with nipple SCH 160
8. Pressure Class	800
9. Temperature	-29°C to 210°C
10. Material Class	Carbon Steel
11. Body Material	ASTM A105
12. Obturator Material	AISI 410 + Hard Coating (acc. Item A.7.1.7.4)
13. Seat Material	AISI 410 + Hard Coating (acc. Item A.7.1.7.4)
14. Seat Insert	N/A
15. Spring (Seat) Material	N/A
16. Stem Material	ASTM A276 (UNS S41000)
17. Seat-Stem Seal	Group D (acc. item A.7.1.5.6)
18. Operator Type	Lever
19. Additional Requirement	Fire Tested (acc. item A.6.1.4); Fugitive Emission (acc. item A.6.1.6)
20. Seat Type	N/A
21. Bore Type	Full Bore
22. Body Construction	split body, bolted
23. Cladding or Coating	N/A
24. Valve Testing	FAT according A.9.3
25. Notes	N/A

Valve Code	VES-803-3-C203
Specs	E6 E19
1. Valve Type	Ball
2. Sealing Type	Soft
3. Valve Specification Level (VSL)	VSL-3
4. Ball Mouting	Floating
5. Standard	ISO 17292
6. Size Range (NPS)	½" - 1 ½"
7. End Connection	socket weld ends ASME B16.11 with nipple SCH 160
8. Pressure Class	800
9. Temperature	-30°C to 150°C
10. Material Class	Low-Temperature Carbon Steel
11. Body Material	ASTM A350 Gr LF2 CL1
12. Obturator Material	AISI 316
13. Seat Material	PEEK
14. Seat Insert	N/A
15. Spring (Seat) Material	N/A
16. Stem Material	ASTM A276 (UNS S31600)
17. Seat-Stem Seal	Group B (acc. item A.7.1.5.6)
18. Operator Type	Lever
19. Additional Requirement	Fire Tested (acc. item A.6.1.4)
20. Seat Type	N/A
21. Bore Type	Full Bore
22. Body Construction	split body, bolted
23. Cladding or Coating	N/A
24. Valve Testing	FAT according A.9.3
25. Notes	N/A

Valve Code	VES-803-3-C204
Specs	E6 E19
1. Valve Type	Ball
2. Sealing Type	Soft
3. Valve Specification Level (VSL)	VSL-3
4. Ball Mouting	Floating
5. Standard	ISO 17292
6. Size Range (NPS)	½" - 1 ½"
7. End Connection	socket weld ends ASME B16.11 with nipple SCH 160
8. Pressure Class	800
9. Temperature	-46°C to 150°C
10. Material Class	Low-Temperature Carbon Steel
11. Body Material	ASTM A350 Gr LF2 CL1
12. Obturator Material	AISI 316
13. Seat Material	PEEK
14. Seat Insert	N/A
15. Spring (Seat) Material	N/A
16. Stem Material	ASTM A276 (UNS S31600)
17. Seat-Stem Seal	Group E (acc. item A.7.1.5.6)
18. Operator Type	Lever
19. Additional Requirement	Fire Tested (acc. item A.6.1.4)
20. Seat Type	N/A
21. Bore Type	Full Bore
22. Body Construction	split body, bolted
23. Cladding or Coating	N/A
24. Valve Testing	FAT according A.9.3
25. Notes	N/A

Valve Code	VES-803-3-C205
Specs	B6 C6 E6 E19
1. Valve Type	Ball
2. Sealing Type	Metal to Metal
3. Valve Specification Level (VSL)	VSL-3
4. Ball Mouting	Floating
5. Standard	ISO 17292
6. Size Range (NPS)	½" - 1 ½"
7. End Connection	socket weld ends ASME B16.11 with nipple SCH 160
8. Pressure Class	800
9. Temperature	-46°C to 200°C
10. Material Class	Low-Temperature Carbon Steel
11. Body Material	ASTM A350 Gr LF2 CL1
12. Obturator Material	AISI 316 + Hard Coating (acc. Item A.7.1.7.4)
13. Seat Material	AISI 316 + Hard Coating (acc. Item A.7.1.7.4)
14. Seat Insert	N/A
15. Spring (Seat) Material	N/A
16. Stem Material	ASTM A276 (UNS S31600)
17. Seat-Stem Seal	Group E (acc. item A.7.1.5.6)
18. Operator Type	Lever
19. Additional Requirement	Fire Tested (acc. item A.6.1.4)
20. Seat Type	N/A
21. Bore Type	Full Bore
22. Body Construction	split body, bolted
23. Cladding or Coating	N/A
24. Valve Testing	FAT according A.9.3
25. Notes	N/A

Valve Code	VES-803-3-C2F1
Specs	B6 C6
1. Valve Type	Ball
2. Sealing Type	Soft
3. Valve Specification Level (VSL)	VSL-3
4. Ball Mouting	Floating
5. Standard	ISO 17292
6. Size Range (NPS)	½" - 1 ½"
7. End Connection	socket weld ends ASME B16.11 with nipple SCH 160
8. Pressure Class	800
9. Temperature	-30°C to 150°C
10. Material Class	Low-Temperature Carbon Steel
11. Body Material	ASTM A350 Gr LF2 CL1
12. Obturator Material	AISI 316
13. Seat Material	PTFE reinforced with 25% Carbon
14. Seat Insert	N/A
15. Spring (Seat) Material	N/A
16. Stem Material	ASTM A276 (UNS S31600)
17. Seat-Stem Seal	Group B (acc. item A.7.1.5.6)
18. Operator Type	Lever
19. Additional Requirement	Fire Tested (acc. item A.6.1.4); Fugitive Emission (acc. item A.6.1.6)
20. Seat Type	N/A
21. Bore Type	Full Bore
22. Body Construction	split body, bolted
23. Cladding or Coating	N/A
24. Valve Testing	FAT according A.9.3
25. Notes	N/A

Valve Code	VES-803-3-C2F2
Specs	B6 C6
1. Valve Type	Ball
2. Sealing Type	Soft
3. Valve Specification Level (VSL)	VSL-3
4. Ball Mouting	Floating
5. Standard	ISO 17292
6. Size Range (NPS)	½" - 1 ½"
7. End Connection	socket weld ends ASME B16.11 with nipple SCH 160
8. Pressure Class	800
9. Temperature	-46°C to 150°C
10. Material Class	Low-Temperature Carbon Steel
11. Body Material	ASTM A350 Gr LF2 CL1
12. Obturator Material	AISI 316
13. Seat Material	PTFE reinforced with 25% Carbon
14. Seat Insert	N/A
15. Spring (Seat) Material	N/A
16. Stem Material	ASTM A276 (UNS S31600)
17. Seat-Stem Seal	Group E (acc. item A.7.1.5.6)
18. Operator Type	Lever
19. Additional Requirement	Fire Tested (acc. item A.6.1.4); Fugitive Emission (acc. item A.6.1.6)
20. Seat Type	N/A
21. Bore Type	Full Bore
22. Body Construction	split body, bolted
23. Cladding or Coating	N/A
24. Valve Testing	FAT according A.9.3
25. Notes	N/A

Valve Code	VES-803-3-C2F3
Specs	E6 E19
1. Valve Type	Ball
2. Sealing Type	Soft
3. Valve Specification Level (VSL)	VSL-3
4. Ball Mouting	Floating
5. Standard	ISO 17292
6. Size Range (NPS)	½" - 1 ½"
7. End Connection	socket weld ends ASME B16.11 with nipple SCH 160
8. Pressure Class	800
9. Temperature	-30°C to 150°C
10. Material Class	Low-Temperature Carbon Steel
11. Body Material	ASTM A350 Gr LF2 CL1
12. Obturator Material	AISI 316
13. Seat Material	PEEK
14. Seat Insert	N/A
15. Spring (Seat) Material	N/A
16. Stem Material	ASTM A276 (UNS S31600)
17. Seat-Stem Seal	Group B (acc. item A.7.1.5.6)
18. Operator Type	Lever
19. Additional Requirement	Fire Tested (acc. item A.6.1.4); Fugitive Emission (acc. item A.6.1.6)
20. Seat Type	N/A
21. Bore Type	Full Bore
22. Body Construction	split body, bolted
23. Cladding or Coating	N/A
24. Valve Testing	FAT according A.9.3
25. Notes	N/A

Valve Code	VES-803-3-C2F4
Specs	E6 E19
1. Valve Type	Ball
2. Sealing Type	Soft
3. Valve Specification Level (VSL)	VSL-3
4. Ball Mouting	Floating
5. Standard	ISO 17292
6. Size Range (NPS)	½" - 1 ½"
7. End Connection	socket weld ends ASME B16.11 with nipple SCH 160
8. Pressure Class	800
9. Temperature	-46°C to 150°C
10. Material Class	Low-Temperature Carbon Steel
11. Body Material	ASTM A350 Gr LF2 CL1
12. Obturator Material	AISI 316
13. Seat Material	PEEK
14. Seat Insert	N/A
15. Spring (Seat) Material	N/A
16. Stem Material	ASTM A276 (UNS S31600)
17. Seat-Stem Seal	Group E (acc. item A.7.1.5.6)
18. Operator Type	Lever
19. Additional Requirement	Fire Tested (acc. item A.6.1.4); Fugitive Emission (acc. item A.6.1.6)
20. Seat Type	N/A
21. Bore Type	Full Bore
22. Body Construction	split body, bolted
23. Cladding or Coating	N/A
24. Valve Testing	FAT according A.9.3
25. Notes	N/A

Valve Code	VES-803-3-C2F5
Specs	B6 C6 E6 E19
1. Valve Type	Ball
2. Sealing Type	Metal to Metal
3. Valve Specification Level (VSL)	VSL-3
4. Ball Mouting	Floating
5. Standard	ISO 17292
6. Size Range (NPS)	½" - 1 ½"
7. End Connection	socket weld ends ASME B16.11 with nipple SCH 160
8. Pressure Class	800
9. Temperature	-46°C to 200°C
10. Material Class	Low-Temperature Carbon Steel
11. Body Material	ASTM A350 Gr LF2 CL1
12. Obturator Material	AISI 316 + Hard Coating (acc. Item A.7.1.7.4)
13. Seat Material	AISI 316 + Hard Coating (acc. Item A.7.1.7.4)
14. Seat Insert	N/A
15. Spring (Seat) Material	N/A
16. Stem Material	ASTM A276 (UNS S31600)
17. Seat-Stem Seal	Group E (acc. item A.7.1.5.6)
18. Operator Type	Lever
19. Additional Requirement	Fire Tested (acc. item A.6.1.4); Fugitive Emission (acc. item A.6.1.6)
20. Seat Type	N/A
21. Bore Type	Full Bore
22. Body Construction	split body, bolted
23. Cladding or Coating	N/A
24. Valve Testing	FAT according A.9.3
25. Notes	N/A

Valve Code	VES-900-1-C214
Specs	F6
1. Valve Type	Ball
2. Sealing Type	Soft
3. Valve Specification Level (VSL)	VSL-1
4. Ball Mouting	Trunnion
5. Standard	API 6D / IOGP S-562
6. Size Range (NPS)	2" - 4"
7. End Connection	RTJ
8. Pressure Class	900
9. Temperature	-30°C to 150°C
10. Material Class	Low-Temperature Carbon Steel
11. Body Material	ASTM A350 Gr LF2 CL1 or ASTM A352 Gr LCC + Inconel 625 weld overlay (acc. item A.7.1.7.3)
12. Obturator Material	AISI 316
13. Seat Material	AISI 316
14. Seat Insert	PEEK
15. Spring (Seat) Material	UNS N07750
16. Stem Material	ASTM A276 (UNS S31600)
17. Seat-Stem Seal	Group B (acc. item A.7.1.5.6)
18. Operator Type	2" - 3" Lever 4" Gearbox
19. Additional Requirement	N/A
20. Seat Type	(For trunnion-mounted) Side A: SPE / Side B: SPE; DBB
21. Bore Type	Full Bore
22. Body Construction	split body, bolted
23. Cladding or Coating	Partial clad - Inconel 625 weld overlay on all body sealing areas
24. Valve Testing	FAT according A.9.3
25. Notes	N/A

Valve Code	VES-900-1-C234
Specs	F6
1. Valve Type	Ball
2. Sealing Type	Soft
3. Valve Specification Level (VSL)	VSL-1
4. Ball Mouting	Trunnion
5. Standard	API 6D / IOGP S-562
6. Size Range (NPS)	2" - 4"
7. End Connection	RTJ
8. Pressure Class	900
9. Temperature	-46°C to 150°C
10. Material Class	Low-Temperature Carbon Steel
11. Body Material	ASTM A350 Gr LF2 CL1 or ASTM A352 Gr LCC + Inconel 625 weld overlay (acc. item A.7.1.7.3)
12. Obturator Material	AISI 316
13. Seat Material	AISI 316
14. Seat Insert	PEEK
15. Spring (Seat) Material	UNS N07750
16. Stem Material	ASTM A276 (UNS S31600)
17. Seat-Stem Seal	Group E (acc. item A.7.1.5.6)
18. Operator Type	2" - 3" Lever 4" Gearbox
19. Additional Requirement	N/A
20. Seat Type	(For trunnion-mounted) Side A: SPE / Side B: SPE; DBB
21. Bore Type	Full Bore
22. Body Construction	split body, bolted
23. Cladding or Coating	Partial clad - Inconel 625 weld overlay on all body sealing areas
24. Valve Testing	FAT according A.9.3
25. Notes	N/A



















Valve Code	VDE-1500-2-S235
Specs	G3
1. Valve Type	Double Ball
2. Sealing Type	Soft
3. Valve Specification Level (VSL)	VSL-2
4. Ball Mouting	Trunnion
5. Standard	API 6D
6. Size Range (NPS)	3" - 8"
7. End Connection	RTJ
8. Pressure Class	1500
9. Temperature	-46°C to 150°C
10. Material Class	Stainless Steel
11. Body Material	ASTM A182 Gr F316 + Inconel 625 weld overlay (acc. item A.7.1.7.3)
12. Obturator Material	AISI 316
13. Seat Material	AISI 316
14. Seat Insert	PEEK
15. Spring (Seat) Material	UNS N07750
16. Stem Material	ASTM B637 (UNS N07718)
17. Seat-Stem Seal	Group E (acc. item A.7.1.5.6)
18. Operator Type	Gearbox
19. Additional Requirement	Fire Tested (acc. item A.6.1.4)
20. Seat Type	(For trunnion-mounted) Side A: SPE / Side B: SPE; DDB
21. Bore Type	Full Bore
22. Body Construction	Compact flangeless single body double ball valve. Face to face according ASME B16.10
23. Cladding or Coating	Partial clad - Inconel 625 weld overlay on all body sealing areas
24. Valve Testing	FAT according A.9.3
25. Notes	All materials described in this datasheet are required for both valve, Needle valve between balls for cavity-pressure relief

Valve Code	VDE-1500-2-S23F
Specs	G3
1. Valve Type	Double Ball
2. Sealing Type	Soft
3. Valve Specification Level (VSL)	VSL-2
4. Ball Mouting	Trunnion
5. Standard	API 6D
6. Size Range (NPS)	3" - 8"
7. End Connection	RTJ
8. Pressure Class	1500
9. Temperature	-46°C to 150°C
10. Material Class	Stainless Steel
11. Body Material	ASTM A182 Gr F316 + Inconel 625 weld overlay (acc. item A.7.1.7.3)
12. Obturator Material	AISI 316
13. Seat Material	AISI 316
14. Seat Insert	PEEK
15. Spring (Seat) Material	UNS N07750
16. Stem Material	ASTM B637 (UNS N07718)
17. Seat-Stem Seal	Group E (acc. item A.7.1.5.6)
18. Operator Type	Gearbox
19. Additional Requirement	Fire Tested (acc. item A.6.1.4); Fugitive Emission (acc. item A.6.1.6)
20. Seat Type	(For trunnion-mounted) Side A: SPE / Side B: SPE; DDB
21. Bore Type	Full Bore
22. Body Construction	Compact flangeless single body double ball valve. Face to face according ASME B16.10
23. Cladding or Coating	Partial clad - Inconel 625 weld overlay on all body sealing areas
24. Valve Testing	FAT according A.9.3
25. Notes	All materials described in this datasheet are required for both valve, Needle valve between balls for cavity-pressure relief

Valve Code	VDE-1500-2-S270
Specs	G3
1. Valve Type	Double Ball
2. Sealing Type	Metal to Metal
3. Valve Specification Level (VSL)	VSL-2
4. Ball Mouting	Trunnion
5. Standard	API 6D
6. Size Range (NPS)	3" - 8"
7. End Connection	RTJ
8. Pressure Class	1500
9. Temperature	-100°C to 200°C
10. Material Class	Stainless Steel
11. Body Material	ASTM A182 Gr F316
12. Obturator Material	AISI 316
13. Seat Material	AISI 316
14. Seat Insert	N/A
15. Spring (Seat) Material	UNS N07750
16. Stem Material	ASTM B637 (UNS N07718)
17. Seat-Stem Seal	Group E (acc. item A.7.1.5.6)
18. Operator Type	Gearbox
19. Additional Requirement	N/A
20. Seat Type	(For trunnion-mounted) Side A: SPE / Side B: SPE
21. Bore Type	Full Bore
22. Body Construction	Compact flangeless single body double ball valve. Face to face according ASME B16.10
23. Cladding or Coating	N/A
24. Valve Testing	FAT according A.9.3
25. Notes	All materials described in this datasheet are required for both valve, Needle valve between balls for cavity-pressure relief

Valve Code	VDE-1500-2-S27F
Specs	G3
1. Valve Type	Double Ball
2. Sealing Type	Metal to Metal
3. Valve Specification Level (VSL)	VSL-2
4. Ball Mouting	Trunnion
5. Standard	API 6D
6. Size Range (NPS)	3" - 8"
7. End Connection	RTJ
8. Pressure Class	1500
9. Temperature	-100°C to 200°C
10. Material Class	Stainless Steel
11. Body Material	ASTM A182 Gr F316
12. Obturator Material	AISI 316
13. Seat Material	AISI 316
14. Seat Insert	N/A
15. Spring (Seat) Material	UNS N07750
16. Stem Material	ASTM B637 (UNS N07718)
17. Seat-Stem Seal	Group E (acc. item A.7.1.5.6)
18. Operator Type	Gearbox
19. Additional Requirement	Fire Tested (acc. item A.6.1.4); Fugitive Emission (acc. item A.6.1.6)
20. Seat Type	(For trunnion-mounted) Side A: SPE / Side B: SPE
21. Bore Type	Full Bore
22. Body Construction	Compact flangeless single body double ball valve. Face to face according ASME B16.10
23. Cladding or Coating	N/A
24. Valve Testing	FAT according A.9.3
25. Notes	All materials described in this datasheet are required for both valve, Needle valve between balls for cavity-pressure relief

Valve Code	VDE-1500-2-S2F1
Specs	G3
1. Valve Type	Double Ball
2. Sealing Type	Soft
3. Valve Specification Level (VSL)	VSL-2
4. Obturator Type	Trunnion
5. Standard	ASME B16.34
6. Size Range (NPS)	½" - 2"
7. End Connection	Flanged ASME B16.5, RTJ
8. Pressure Class	1500
9. Temperature	-30°C to 150°C
10. Material Class	Stainless Steel
11. Body Material	ASTM A182 Gr F316
12. Obturator Material	AISI 316
13. Seat Material	AISI 316
14. Seat Insert	PEEK
15. Spring Material	UNS N07750
16. Stem Material	ASTM A276 (UNS S31600)
17. Stem Seal Material	Group B (acc. item A.7.1.5.6)
18. Operator Type	Lever
19. Additional Requirement	Fire Tested (acc. item A.6.1.4); Fugitive Emission (acc. item A.6.1.6)
20. Seat Type	(For trunnion-mounted) Side A: SPE / Side B: SPE
21. Bore Type	Full Bore
22. Body Construction	One piece forged body
23. Product Testing	FAT according A.9.3
24. Cladding or Coating	N/A
25. Notes	Needle valve between balls for cavity-pressure relief Max weight 55kg Minimum bore size 10mm

Valve Code	VDE-1500-2-S2F2
Specs	G3
1. Valve Type	Double Ball
2. Sealing Type	Soft
3. Valve Specification Level (VSL)	VSL-2
4. Obturator Type	Trunnion
5. Standard	ASME B16.34
6. Size Range (NPS)	½" - 2"
7. End Connection	Flanged ASME B16.5, RTJ x NPT 1/2" ASME B1.20.1
8. Pressure Class	1500
9. Temperature	-30°C to 150°C
10. Material Class	Stainless Steel
11. Body Material	ASTM A182 Gr F316
12. Obturator Material	AISI 316
13. Seat Material	AISI 316
14. Seat Insert	PEEK
15. Spring Material	UNS N07750
16. Stem Material	ASTM A276 (UNS S31600)
17. Stem Seal Material	Group B (acc. item A.7.1.5.6)
18. Operator Type	Lever
19. Additional Requirement	Fire Tested (acc. item A.6.1.4); Fugitive Emission (acc. item A.6.1.6)
20. Seat Type	(For trunnion-mounted) Side A: SPE / Side B: SPE
21. Bore Type	Full Bore
22. Body Construction	One piece forged body
23. Product Testing	FAT according A.9.3
24. Cladding or Coating	N/A
25. Notes	Needle valve between balls for cavity-pressure relief Max weight 55kg Minimum bore size 10mm

Valve Code	VDE-1500-2-S2F3
Specs	G3
1. Valve Type	Double Ball
2. Sealing Type	Soft
3. Valve Specification Level (VSL)	VSL-2
4. Obturator Type	Trunnion
5. Standard	ASME B16.34
6. Size Range (NPS)	½" - 2"
7. End Connection	Flanged ASME B16.5, RTJ
8. Pressure Class	1500
9. Temperature	-46°C to 150°C
10. Material Class	Stainless Steel
11. Body Material	ASTM A182 Gr F316
12. Obturator Material	AISI 316
13. Seat Material	AISI 316
14. Seat Insert	PEEK
15. Spring Material	UNS N07750
16. Stem Material	ASTM A276 (UNS S31600)
17. Stem Seal Material	Group E (acc. item A.7.1.5.6)
18. Operator Type	Lever
19. Additional Requirement	Fire Tested (acc. item A.6.1.4); Fugitive Emission (acc. item A.6.1.6)
20. Seat Type	(For trunnion-mounted) Side A: SPE / Side B: SPE
21. Bore Type	Full Bore
22. Body Construction	One piece forged body
23. Product Testing	FAT according A.9.3
24. Cladding or Coating	N/A
25. Notes	Needle valve between balls for cavity-pressure relief Max weight 55kg Minimum bore size 10mm

Valve Code	VDE-1500-2-S2F4
Specs	G3
1. Valve Type	Double Ball
2. Sealing Type	Soft
3. Valve Specification Level (VSL)	VSL-2
4. Obturator Type	Trunnion
5. Standard	ASME B16.34
6. Size Range (NPS)	½" - 2"
7. End Connection	Flanged ASME B16.5, RTJ x NPT 1/2" ASME B1.20.1
8. Pressure Class	1500
9. Temperature	-46°C to 150°C
10. Material Class	Stainless Steel
11. Body Material	ASTM A182 Gr F316
12. Obturator Material	AISI 316
13. Seat Material	AISI 316
14. Seat Insert	PEEK
15. Spring Material	UNS N07750
16. Stem Material	ASTM A276 (UNS S31600)
17. Stem Seal Material	Group E (acc. item A.7.1.5.6)
18. Operator Type	Lever
19. Additional Requirement	Fire Tested (acc. item A.6.1.4); Fugitive Emission (acc. item A.6.1.6)
20. Seat Type	(For trunnion-mounted) Side A: SPE / Side B: SPE
21. Bore Type	Full Bore
22. Body Construction	One piece forged body
23. Product Testing	FAT according A.9.3
24. Cladding or Coating	N/A
25. Notes	Needle valve between balls for cavity-pressure relief Max weight 55kg Minimum bore size 10mm

Valve Code	VDE-1500-2-S2F5
Specs	G3
1. Valve Type	Double Ball
2. Sealing Type	Metal to Metal
3. Valve Specification Level (VSL)	VSL-2
4. Obturator Type	Trunnion
5. Standard	ASME B16.34
6. Size Range (NPS)	½" - 2"
7. End Connection	Flanged ASME B16.5, RTJ
8. Pressure Class	1500
9. Temperature	-100°C to 200°C
10. Material Class	Stainless Steel
11. Body Material	ASTM A182 Gr F316
12. Obturator Material	AISI 316 + Hard Coating (acc. Item A.7.1.7.4)
13. Seat Material	AISI 316 + Hard Coating (acc. Item A.7.1.7.4)
14. Seat Insert	N/A
15. Spring Material	UNS N07750
16. Stem Material	ASTM A276 (UNS S31600)
17. Stem Seal Material	Group E (acc. item A.7.1.5.6)
18. Operator Type	Lever
19. Additional Requirement	Fire Tested (acc. item A.6.1.4); Fugitive Emission (acc. item A.6.1.6)
20. Seat Type	(For trunnion-mounted) Side A: SPE / Side B: SPE
21. Bore Type	Full Bore
22. Body Construction	One piece forged body
23. Product Testing	FAT according A.9.3
24. Cladding or Coating	N/A
25. Notes	Needle valve between balls for cavity-pressure relief Max weight 55kg Minimum bore size 10mm

Valve Code	VDE-1500-2-S2F6
Specs	G3
1. Valve Type	Double Ball
2. Sealing Type	Metal to Metal
3. Valve Specification Level (VSL)	VSL-2
4. Obturator Type	Trunnion
5. Standard	ASME B16.34
6. Size Range (NPS)	½" - 2"
7. End Connection	Flanged ASME B16.5, RTJ x NPT 1/2" ASME B1.20.1
8. Pressure Class	1500
9. Temperature	-100°C to 200°C
10. Material Class	Stainless Steel
11. Body Material	ASTM A182 Gr F316
12. Obturator Material	AISI 316 + Hard Coating (acc. Item A.7.1.7.4)
13. Seat Material	AISI 316 + Hard Coating (acc. Item A.7.1.7.4)
14. Seat Insert	N/A
15. Spring Material	UNS N07750
16. Stem Material	ASTM A276 (UNS S31600)
17. Stem Seal Material	Group E (acc. item A.7.1.5.6)
18. Operator Type	Lever
19. Additional Requirement	Fire Tested (acc. item A.6.1.4); Fugitive Emission (acc. item A.6.1.6)
20. Seat Type	(For trunnion-mounted) Side A: SPE / Side B: SPE
21. Bore Type	Full Bore
22. Body Construction	One piece forged body
23. Product Testing	FAT according A.9.3
24. Cladding or Coating	N/A
25. Notes	Needle valve between balls for cavity-pressure relief Max weight 55kg Minimum bore size 10mm

Valve Code	VDE-150-1-D201
Specs	B11 B26
1. Valve Type	Double Ball
2. Sealing Type	Soft
3. Valve Specification Level (VSL)	VSL-1
4. Obturator Type	Floating
5. Standard	ASME B16.34
6. Size Range (NPS)	1" - 2"
7. End Connection	Flanged ASME B16.5, RF
8. Pressure Class	150
9. Temperature	-30°C to 150°C
10. Material Class	Duplex Steel
11. Body Material	ASTM A182 Gr F51
12. Obturator Material	Duplex (UNS S31803)
13. Seat Material	PTFE reinforced with 25% Carbon
14. Seat Insert	N/A
15. Spring Material	N/A
16. Stem Material	ASTM A276 (UNS S31803)
17. Stem Seal Material	Group B (acc. item A.7.1.5.6)
18. Operator Type	Lever
19. Additional Requirement	Fire Tested (acc. item A.6.1.4)
20. Seat Type	N/A
21. Bore Type	Full Bore
22. Body Construction	One piece forged body
23. Product Testing	FAT according A.9.3
24. Cladding or Coating	N/A
25. Notes	Needle valve between balls for cavity-pressure relief Max weight 55kg Minimum bore size 10mm

Valve Code	VDE-150-2-C101
Specs	B9 B10
1. Valve Type	Double Ball
2. Sealing Type	Soft
3. Valve Specification Level (VSL)	VSL-2
4. Obturator Type	Floating
5. Standard	ASME B16.34
6. Size Range (NPS)	½" - 2"
7. End Connection	Flanged ASME B16.5, RF
8. Pressure Class	150
9. Temperature	-29°C to 150°C
10. Material Class	Carbon Steel
11. Body Material	ASTM A105
12. Obturator Material	AISI 410
13. Seat Material	PTFE reinforced with 25% Carbon
14. Seat Insert	N/A
15. Spring Material	N/A
16. Stem Material	ASTM A276 (UNS S31600)
17. Stem Seal Material	Group B (acc. item A.7.1.5.6)
18. Operator Type	Lever
19. Additional Requirement	Fire Tested (acc. item A.6.1.4)
20. Seat Type	N/A
21. Bore Type	Full Bore
22. Body Construction	One piece forged body
23. Product Testing	FAT according A.9.3
24. Cladding or Coating	N/A
25. Notes	Needle valve between balls for cavity-pressure relief Max weight 55kg Minimum bore size 10mm



Valve Code	VDE-150-2-C102
Specs	B10
1. Valve Type	Double Ball
2. Sealing Type	Soft
3. Valve Specification Level (VSL)	VSL-2
4. Obturator Type	Floating
5. Standard	ASME B16.34
6. Size Range (NPS)	½" - 2"
7. End Connection	Flanged ASME B16.5, RF x NPT 1/2" ASME B1.20.1
8. Pressure Class	150
9. Temperature	-29°C to 150°C
10. Material Class	Carbon Steel
11. Body Material	ASTM A105
12. Obturator Material	AISI 410
13. Seat Material	PTFE reinforced with 25% Carbon
14. Seat Insert Material	N/A
15. Spring Material	N/A
16. Stem Material	ASTM A276 (UNS S31600)
17. Stem Seal Material	Group B (acc. item A.7.1.5.6)
18. Operator Type	Lever
19. Additional Requirement	Fire Tested (acc. item A.6.1.4)
20. Seat Type	N/A
21. Bore Type	Full Bore
22. Body Construction	One piece forged body
23. Product Testing	FAT according A.9.3
24. Cladding or Coating	N/A
25. Notes	Needle valve between balls for cavity-pressure relief Max weight 55kg Minimum bore size 10mm

Valve Code	VDE-150-2-C105
Specs	B10
1. Valve Type	Double Ball
2. Sealing Type	Metal to Metal
3. Valve Specification Level (VSL)	VSL-2
4. Obturator Type	Floating
5. Standard	ASME B16.34
6. Size Range (NPS)	½" - 2"
7. End Connection	Flanged ASME B16.5, RF
8. Pressure Class	150
9. Temperature	-29°C to 200°C
10. Material Class	Carbon Steel
11. Body Material	ASTM A105
12. Obturator Material	AISI 410
13. Seat Material	AISI 316
14. Seat Insert Material	N/A
15. Spring Material	N/A
16. Stem Material	ASTM A276 (UNS S31600)
17. Stem Seal Material	Group E (acc. item A.7.1.5.6)
18. Operator Type	Lever
19. Additional Requirement	Fire Tested (acc. item A.6.1.4)
20. Seat Type	N/A
21. Bore Type	Full Bore
22. Body Construction	One piece forged body
23. Product Testing	FAT according A.9.3
24. Cladding or Coating	N/A
25. Notes	Needle valve between balls for cavity-pressure relief Max weight 55kg Minimum bore size 10mm

Valve Code	VDE-150-2-C106
Specs	B10
1. Valve Type	Double Ball
2. Sealing Type	Metal to Metal
3. Valve Specification Level (VSL)	VSL-2
4. Obturator Type	Floating
5. Standard	ASME B16.34
6. Size Range (NPS)	½" - 2"
7. End Connection	Flanged ASME B16.5, RF x NPT 1/2" ASME B1.20.1
8. Pressure Class	150
9. Temperature	-29°C to 200°C
10. Material Class	Carbon Steel
11. Body Material	ASTM A105
12. Obturator Material	AISI 410
13. Seat Material	AISI 316
14. Seat Insert Material	N/A
15. Spring Material	N/A
16. Stem Material	ASTM A276 (UNS S31600)
17. Stem Seal Material	Group E (acc. item A.7.1.5.6)
18. Operator Type	Lever
19. Additional Requirement	Fire Tested (acc. item A.6.1.4)
20. Seat Type	N/A
21. Bore Type	Full Bore
22. Body Construction	One piece forged body
23. Product Testing	FAT according A.9.3
24. Cladding or Coating	N/A
25. Notes	Needle valve between balls for cavity-pressure relief Max weight 55kg Minimum bore size 10mm

Valve Code	VDE-150-2-C107
Specs	B10
1. Valve Type	Double Ball
2. Sealing Type	Metal to Metal
3. Valve Specification Level (VSL)	VSL-2
4. Obturator Type	Floating
5. Standard	ASME B16.34
6. Size Range (NPS)	½" - 2"
7. End Connection	Flanged ASME B16.5, RF
8. Pressure Class	150
9. Temperature	-29°C to 340°C
10. Material Class	Carbon Steel
11. Body Material	ASTM A105
12. Obturator Material	AISI 410
13. Seat Material	AISI 316
14. Seat Insert Material	N/A
15. Spring Material	N/A
16. Stem Material	ASTM A276 (UNS S31600)
17. Stem Seal Material	Group F (acc. item A.7.1.5.6)
18. Operator Type	Lever
19. Additional Requirement	Fire Tested (acc. item A.6.1.4)
20. Seat Type	N/A
21. Bore Type	Full Bore
22. Body Construction	One piece forged body
23. Product Testing	FAT according A.9.3
24. Cladding or Coating	N/A
25. Notes	Needle valve between balls for cavity-pressure relief Max weight 55kg Minimum bore size 10mm

Valve Code	VDE-150-2-C108
Specs	B10
1. Valve Type	Double Ball
2. Sealing Type	Metal to Metal
3. Valve Specification Level (VSL)	VSL-2
4. Obturator Type	Floating
5. Standard	ASME B16.34
6. Size Range (NPS)	½" - 2"
7. End Connection	Flanged ASME B16.5, RF x NPT 1/2" ASME B1.20.1
8. Pressure Class	150
9. Temperature	-29°C to 340°C
10. Material Class	Carbon Steel
11. Body Material	ASTM A105
12. Obturator Material	AISI 410
13. Seat Material	AISI 316
14. Seat Insert Material	N/A
15. Spring Material	N/A
16. Stem Material	ASTM A276 (UNS S31600)
17. Stem Seal Material	Group F (acc. item A.7.1.5.6)
18. Operator Type	Lever
19. Additional Requirement	Fire Tested (acc. item A.6.1.4)
20. Seat Type	N/A
21. Bore Type	Full Bore
22. Body Construction	One piece forged body
23. Product Testing	FAT according A.9.3
24. Cladding or Coating	N/A
25. Notes	Needle valve between balls for cavity-pressure relief Max weight 55kg Minimum bore size 10mm

Valve Code	VDE-150-2-C114
Specs	B10
1. Valve Type	Double Ball
2. Sealing Type	Soft
3. Valve Specification Level (VSL)	VSL-2
4. Ball Mounting	Trunnion
5. Standard	API 6D
6. Size Range (NPS)	3" - 8"
7. End Connection	RF
8. Pressure Class	150
9. Temperature	-29°C to 150°C
10. Material Class	Carbon Steel
11. Body Material	ASTM A105 or ASTM A216 Gr WCB + SS316 weld overlay (acc. item A.7.1.7.3)
12. Obturator Material	AISI 410
13. Seat Material	AISI 410
14. Seat Insert	PEEK
15. Spring (Seat) Material	UNS N07750
16. Stem Material	ASTM A276 (UNS S41000)
17. Seat-Stem Seal	Group B (acc. item A.7.1.5.6)
18. Operator Type	3" Lever 4" - 8" Gearbox
19. Additional Requirement	N/A
20. Seat Type	(For trunnion-mounted) Side A: SPE / Side B: SPE; DBB
21. Bore Type	Full Bore
22. Body Construction	Compact flangeless single body double ball valve. Face to face according ASME B16.10
23. Cladding or Coating	Partial clad - SS316 weld overlay on all body sealing areas
24. Valve Testing	FAT according A.9.3
25. Notes	All materials described in this datasheet are required for both valve, Needle valve between balls for cavity-pressure relief

Valve Code	VDE-150-2-C115
Specs	B10
1. Valve Type	Double Ball
2. Sealing Type	Soft
3. Valve Specification Level (VSL)	VSL-2
4. Ball Mounting	Trunnion
5. Standard	API 6D
6. Size Range (NPS)	3" - 8"
7. End Connection	RF
8. Pressure Class	150
9. Temperature	-29°C to 150°C
10. Material Class	Carbon Steel
11. Body Material	ASTM A105 or ASTM A216 Gr WCB + SS316 weld overlay (acc. item A.7.1.7.3)
12. Obturator Material	AISI 410
13. Seat Material	AISI 410
14. Seat Insert	PEEK
15. Spring (Seat) Material	UNS N07750
16. Stem Material	ASTM A276 (UNS S41000)
17. Seat-Stem Seal	Group B (acc. item A.7.1.5.6)
18. Operator Type	3" Lever 4" - 8" Gearbox
19. Additional Requirement	Fire Tested (acc. item A.6.1.4)
20. Seat Type	(For trunnion-mounted) Side A: SPE / Side B: SPE; DBB
21. Bore Type	Full Bore
22. Body Construction	Compact flangeless single body double ball valve. Face to face according ASME B16.10
23. Cladding or Coating	Partial clad - SS316 weld overlay on all body sealing areas
24. Valve Testing	FAT according A.9.3
25. Notes	All materials described in this datasheet are required for both valve, Needle valve between balls for cavity-pressure relief

Valve Code	VDE-150-2-C11F
Specs	B9 B10
1. Valve Type	Double Ball
2. Sealing Type	Soft
3. Valve Specification Level (VSL)	VSL-2
4. Ball Mounting	Trunnion
5. Standard	API 6D
6. Size Range (NPS)	3" - 8"
7. End Connection	RF
8. Pressure Class	150
9. Temperature	-29°C to 150°C
10. Material Class	Carbon Steel
11. Body Material	ASTM A105 or ASTM A216 Gr WCB + SS316 weld overlay (acc. item A.7.1.7.3)
12. Obturator Material	AISI 410
13. Seat Material	AISI 410
14. Seat Insert	PTFE reinforced with 25% Carbon
15. Spring (Seat) Material	UNS N07750
16. Stem Material	ASTM A276 (UNS S41000)
17. Seat-Stem Seal	Group B (acc. item A.7.1.5.6)
18. Operator Type	3" Lever 4" - 8" Gearbox
19. Additional Requirement	Fire Tested (acc. item A.6.1.4); Fugitive Emission (acc. item A.6.1.6)
20. Seat Type	(For trunnion-mounted) Side A: SPE / Side B: SPE
21. Bore Type	Full Bore
22. Body Construction	Compact flangeless single body double ball valve. Face to face according ASME B16.10
23. Cladding or Coating	Partial clad - SS316 weld overlay on all body sealing areas
24. Valve Testing	FAT according A.9.3
25. Notes	All materials described in this datasheet are required for both valve, Needle valve between balls for cavity-pressure relief

Valve Code	VDE-150-2-C1F1
Specs	B9 B10
1. Valve Type	Double Ball
2. Sealing Type	Soft
3. Valve Specification Level (VSL)	VSL-2
4. Obturator Type	Floating
5. Standard	ASME B16.34
6. Size Range (NPS)	½" - 2"
7. End Connection	Flanged ASME B16.5, RF
8. Pressure Class	150
9. Temperature	-29°C to 150°C
10. Material Class	Carbon Steel
11. Body Material	ASTM A105
12. Obturator Material	AISI 410
13. Seat Material	PTFE reinforced with 25% Carbon
14. Seat Insert Material	N/A
15. Spring Material	N/A
16. Stem Material	ASTM A276 (UNS S31600)
17. Stem Seal Material	Group B (acc. item A.7.1.5.6)
18. Operator Type	Lever
19. Additional Requirement	Fire Tested (acc. item A.6.1.4); Fugitive Emission (acc. item A.6.1.6)
20. Seat Type	N/A
21. Bore Type	Full Bore
22. Body Construction	One piece forged body
23. Product Testing	FAT according A.9.3
24. Cladding or Coating	N/A
25. Notes	Needle valve between balls for cavity-pressure relief Max weight 55kg Minimum bore size 10mm

Valve Code	VDE-150-2-C1F2
Specs	B9 B10
1. Valve Type	Double Ball
2. Sealing Type	Soft
3. Valve Specification Level (VSL)	VSL-2
4. Obturator Type	Floating
5. Standard	ASME B16.34
6. Size Range (NPS)	½" - 2"
7. End Connection	Flanged ASME B16.5, RF x NPT 1/2" ASME B1.20.1
8. Pressure Class	150
9. Temperature	-29°C to 150°C
10. Material Class	Carbon Steel
11. Body Material	ASTM A105
12. Obturator Material	AISI 410
13. Seat Material	PTFE reinforced with 25% Carbon
14. Seat Insert Material	N/A
15. Spring Material	N/A
16. Stem Material	ASTM A276 (UNS S31600)
17. Stem Seal Material	Group B (acc. item A.7.1.5.6)
18. Operator Type	Lever
19. Additional Requirement	Fire Tested (acc. item A.6.1.4); Fugitive Emission (acc. item A.6.1.6)
20. Seat Type	N/A
21. Bore Type	Full Bore
22. Body Construction	One piece forged body
23. Product Testing	FAT according A.9.3
24. Cladding or Coating	N/A
25. Notes	Needle valve between balls for cavity-pressure relief Max weight 55kg Minimum bore size 10mm

Valve Code	VDE-150-2-C1F5
Specs	B9 B10
1. Valve Type	Double Ball
2. Sealing Type	Metal to Metal
3. Valve Specification Level (VSL)	VSL-2
4. Obturator Type	Floating
5. Standard	ASME B16.34
6. Size Range (NPS)	½" - 2"
7. End Connection	Flanged ASME B16.5, RF
8. Pressure Class	150
9. Temperature	-29°C to 200°C
10. Material Class	Carbon Steel
11. Body Material	ASTM A105
12. Obturator Material	AISI 410
13. Seat Material	AISI 316
14. Seat Insert Material	N/A
15. Spring Material	N/A
16. Stem Material	ASTM A276 (UNS S31600)
17. Stem Seal Material	Group E (acc. item A.7.1.5.6)
18. Operator Type	Lever
19. Additional Requirement	Fire Tested (acc. item A.6.1.4); Fugitive Emission (acc. item A.6.1.6)
20. Seat Type	N/A
21. Bore Type	Full Bore
22. Body Construction	One piece forged body
23. Product Testing	FAT according A.9.3
24. Cladding or Coating	N/A
25. Notes	Needle valve between balls for cavity-pressure relief Max weight 55kg Minimum bore size 10mm

Valve Code	VDE-150-2-C1F6
Specs	B9 B10
1. Valve Type	Double Ball
2. Sealing Type	Metal to Metal
3. Valve Specification Level (VSL)	VSL-2
4. Obturator Type	Floating
5. Standard	ASME B16.34
6. Size Range (NPS)	½" - 2"
7. End Connection	Flanged ASME B16.5, RF x NPT 1/2" ASME B1.20.1
8. Pressure Class	150
9. Temperature	-29°C to 200°C
10. Material Class	Carbon Steel
11. Body Material	ASTM A105
12. Obturator Material	AISI 410
13. Seat Material	AISI 316
14. Seat Insert Material	N/A
15. Spring Material	N/A
16. Stem Material	ASTM A276 (UNS S31600)
17. Stem Seal Material	Group E (acc. item A.7.1.5.6)
18. Operator Type	Lever
19. Additional Requirement	Fire Tested (acc. item A.6.1.4); Fugitive Emission (acc. item A.6.1.6)
20. Seat Type	N/A
21. Bore Type	Full Bore
22. Body Construction	One piece forged body
23. Product Testing	FAT according A.9.3
24. Cladding or Coating	N/A
25. Notes	Needle valve between balls for cavity-pressure relief Max weight 55kg Minimum bore size 10mm

Valve Code	VDE-150-2-C1F7
Specs	B9 B10
1. Valve Type	Double Ball
2. Sealing Type	Metal to Metal
3. Valve Specification Level (VSL)	VSL-2
4. Obturator Type	Floating
5. Standard	ASME B16.34
6. Size Range (NPS)	½" - 2"
7. End Connection	Flanged ASME B16.5, RF
8. Pressure Class	150
9. Temperature	-29°C to 340°C
10. Material Class	Carbon Steel
11. Body Material	ASTM A105
12. Obturator Material	AISI 410
13. Seat Material	AISI 316
14. Seat Insert Material	N/A
15. Spring Material	N/A
16. Stem Material	ASTM A276 (UNS S31600)
17. Stem Seal Material	Group F (acc. item A.7.1.5.6)
18. Operator Type	Lever
19. Additional Requirement	Fire Tested (acc. item A.6.1.4); Fugitive Emission (acc. item A.6.1.6)
20. Seat Type	N/A
21. Bore Type	Full Bore
22. Body Construction	One piece forged body
23. Product Testing	FAT according A.9.3
24. Cladding or Coating	N/A
25. Notes	Needle valve between balls for cavity-pressure relief Max weight 55kg Minimum bore size 10mm

Valve Code	VDE-150-2-C1F8
Specs	B9 B10
1. Valve Type	Double Ball
2. Sealing Type	Metal to Metal
3. Valve Specification Level (VSL)	VSL-2
4. Obturator Type	Floating
5. Standard	ASME B16.34
6. Size Range (NPS)	½" - 2"
7. End Connection	Flanged ASME B16.5, RF x NPT 1/2" ASME B1.20.1
8. Pressure Class	150
9. Temperature	-29°C to 340°C
10. Material Class	Carbon Steel
11. Body Material	ASTM A105
12. Obturator Material	AISI 410
13. Seat Material	AISI 316
14. Seat Insert Material	N/A
15. Spring Material	N/A
16. Stem Material	ASTM A276 (UNS S31600)
17. Stem Seal Material	Group F (acc. item A.7.1.5.6)
18. Operator Type	Lever
19. Additional Requirement	Fire Tested (acc. item A.6.1.4); Fugitive Emission (acc. item A.6.1.6)
20. Seat Type	N/A
21. Bore Type	Full Bore
22. Body Construction	One piece forged body
23. Product Testing	FAT according A.9.3
24. Cladding or Coating	N/A
25. Notes	Needle valve between balls for cavity-pressure relief Max weight 55kg Minimum bore size 10mm

Valve Code	VDE-150-2-C201
Specs	B6
1. Valve Type	Double Ball
2. Sealing Type	Soft
3. Valve Specification Level (VSL)	VSL-2
4. Obturator Type	Floating
5. Standard	ASME B16.34
6. Size Range (NPS)	½" - 2"
7. End Connection	Flanged ASME B16.5, RF
8. Pressure Class	150
9. Temperature	-30°C to 150°C
10. Material Class	Low-Temperature Carbon Steel
11. Body Material	ASTM A350 Gr LF2 CL1
12. Obturator Material	AISI 316
13. Seat Material	PTFE reinforced with 25% Carbon
14. Seat Insert Material	N/A
15. Spring Material	N/A
16. Stem Material	ASTM A276 (UNS S31600)
17. Stem Seal Material	Group B (acc. item A.7.1.5.6)
18. Operator Type	Lever
19. Additional Requirement	Fire Tested (acc. item A.6.1.4)
20. Seat Type	N/A
21. Bore Type	Full Bore
22. Body Construction	One piece forged body
23. Product Testing	FAT according A.9.3
24. Cladding or Coating	N/A
25. Notes	Needle valve between balls for cavity-pressure relief Max weight 55kg Minimum bore size 10mm

Valve Code	VDE-150-2-C202
Specs	B6
1. Valve Type	Double Ball
2. Sealing Type	Soft
3. Valve Specification Level (VSL)	VSL-2
4. Obturator Type	Floating
5. Standard	ASME B16.34
6. Size Range (NPS)	½" - 2"
7. End Connection	Flanged ASME B16.5, RF x NPT 1/2" ASME B1.20.1
8. Pressure Class	150
9. Temperature	-30°C to 150°C
10. Material Class	Low-Temperature Carbon Steel
11. Body Material	ASTM A350 Gr LF2 CL1
12. Obturator Material	AISI 316
13. Seat Material	PTFE reinforced with 25% Carbon
14. Seat Insert Material	N/A
15. Spring Material	N/A
16. Stem Material	ASTM A276 (UNS S31600)
17. Stem Seal Material	Group B (acc. item A.7.1.5.6)
18. Operator Type	Lever
19. Additional Requirement	Fire Tested (acc. item A.6.1.4)
20. Seat Type	N/A
21. Bore Type	Full Bore
22. Body Construction	One piece forged body
23. Product Testing	FAT according A.9.3
24. Cladding or Coating	N/A
25. Notes	Needle valve between balls for cavity-pressure relief Max weight 55kg Minimum bore size 10mm

Valve Code	VDE-150-2-C203
Specs	B6
1. Valve Type	Double Ball
2. Sealing Type	Soft
3. Valve Specification Level (VSL)	VSL-2
4. Obturator Type	Floating
5. Standard	ASME B16.34
6. Size Range (NPS)	½" - 2"
7. End Connection	Flanged ASME B16.5, RF
8. Pressure Class	150
9. Temperature	-46°C to 150°C
10. Material Class	Low-Temperature Carbon Steel
11. Body Material	ASTM A350 Gr LF2 CL1
12. Obturator Material	AISI 316
13. Seat Material	PTFE reinforced with 25% Carbon
14. Seat Insert Material	N/A
15. Spring Material	N/A
16. Stem Material	ASTM A276 (UNS S31600)
17. Stem Seal Material	Group E (acc. item A.7.1.5.6)
18. Operator Type	Lever
19. Additional Requirement	Fire Tested (acc. item A.6.1.4)
20. Seat Type	N/A
21. Bore Type	Full Bore
22. Body Construction	One piece forged body
23. Product Testing	FAT according A.9.3
24. Cladding or Coating	N/A
25. Notes	Needle valve between balls for cavity-pressure relief Max weight 55kg Minimum bore size 10mm

Valve Code	VDE-150-2-C204
Specs	B6
1. Valve Type	Double Ball
2. Sealing Type	Soft
3. Valve Specification Level (VSL)	VSL-2
4. Obturator Type	Floating
5. Standard	ASME B16.34
6. Size Range (NPS)	½" - 2"
7. End Connection	Flanged ASME B16.5, RF x NPT 1/2" ASME B1.20.1
8. Pressure Class	150
9. Temperature	-46°C to 150°C
10. Material Class	Low-Temperature Carbon Steel
11. Body Material	ASTM A350 Gr LF2 CL1
12. Obturator Material	AISI 316
13. Seat Material	PTFE reinforced with 25% Carbon
14. Seat Insert Material	N/A
15. Spring Material	N/A
16. Stem Material	ASTM A276 (UNS S31600)
17. Stem Seal Material	Group E (acc. item A.7.1.5.6)
18. Operator Type	Lever
19. Additional Requirement	Fire Tested (acc. item A.6.1.4)
20. Seat Type	N/A
21. Bore Type	Full Bore
22. Body Construction	One piece forged body
23. Product Testing	FAT according A.9.3
24. Cladding or Coating	N/A
25. Notes	Needle valve between balls for cavity-pressure relief Max weight 55kg Minimum bore size 10mm

Valve Code	VDE-150-2-C205
Specs	B6
1. Valve Type	Double Ball
2. Sealing Type	Metal to Metal
3. Valve Specification Level (VSL)	VSL-2
4. Obturator Type	Floating
5. Standard	ASME B16.34
6. Size Range (NPS)	½" - 2"
7. End Connection	Flanged ASME B16.5, RF
8. Pressure Class	150
9. Temperature	-46°C to 200°C
10. Material Class	Low-Temperature Carbon Steel
11. Body Material	ASTM A350 Gr LF2 CL1
12. Obturator Material	AISI 316
13. Seat Material	AISI 316
14. Seat Insert Material	N/A
15. Spring Material	N/A
16. Stem Material	ASTM A276 (UNS S31600)
17. Stem Seal Material	Group E (acc. item A.7.1.5.6)
18. Operator Type	Lever
19. Additional Requirement	Fire Tested (acc. item A.6.1.4)
20. Seat Type	N/A
21. Bore Type	Full Bore
22. Body Construction	One piece forged body
23. Product Testing	FAT according A.9.3
24. Cladding or Coating	N/A
25. Notes	Needle valve between balls for cavity-pressure relief Max weight 55kg Minimum bore size 10mm

Valve Code	VDE-150-2-C206
Specs	B6
1. Valve Type	Double Ball
2. Sealing Type	Metal to Metal
3. Valve Specification Level (VSL)	VSL-2
4. Obturator Type	Floating
5. Standard	ASME B16.34
6. Size Range (NPS)	½" - 2"
7. End Connection	Flanged ASME B16.5, RF x NPT 1/2" ASME B1.20.1
8. Pressure Class	150
9. Temperature	-46°C to 200°C
10. Material Class	Low-Temperature Carbon Steel
11. Body Material	ASTM A350 Gr LF2 CL1
12. Obturator Material	AISI 316
13. Seat Material	AISI 316
14. Seat Insert Material	N/A
15. Spring Material	N/A
16. Stem Material	ASTM A276 (UNS S31600)
17. Stem Seal Material	Group E (acc. item A.7.1.5.6)
18. Operator Type	Lever
19. Additional Requirement	Fire Tested (acc. item A.6.1.4)
20. Seat Type	N/A
21. Bore Type	Full Bore
22. Body Construction	One piece forged body
23. Product Testing	FAT according A.9.3
24. Cladding or Coating	N/A
25. Notes	Needle valve between balls for cavity-pressure relief Max weight 55kg Minimum bore size 10mm

Valve Code	VDE-150-2-C207
Specs	B6
1. Valve Type	Double Ball
2. Sealing Type	Metal to Metal
3. Valve Specification Level (VSL)	VSL-2
4. Obturator Type	Floating
5. Standard	ASME B16.34
6. Size Range (NPS)	½" - 2"
7. End Connection	Flanged ASME B16.5, RF
8. Pressure Class	150
9. Temperature	-46°C to 340°C
10. Material Class	Low-Temperature Carbon Steel
11. Body Material	ASTM A350 Gr LF2 CL1
12. Obturator Material	AISI 316
13. Seat Material	AISI 316
14. Seat Insert Material	N/A
15. Spring Material	N/A
16. Stem Material	ASTM A276 (UNS S31600)
17. Stem Seal Material	Group F (acc. item A.7.1.5.6)
18. Operator Type	Lever
19. Additional Requirement	Fire Tested (acc. item A.6.1.4)
20. Seat Type	N/A
21. Bore Type	Full Bore
22. Body Construction	One piece forged body
23. Product Testing	FAT according A.9.3
24. Cladding or Coating	N/A
25. Notes	Needle valve between balls for cavity-pressure relief Max weight 55kg Minimum bore size 10mm

Valve Code	VDE-150-2-C208
Specs	B6
1. Valve Type	Double Ball
2. Sealing Type	Metal to Metal
3. Valve Specification Level (VSL)	VSL-2
4. Obturator Type	Floating
5. Standard	ASME B16.34
6. Size Range (NPS)	½" - 2"
7. End Connection	Flanged ASME B16.5, RF x NPT 1/2" ASME B1.20.1
8. Pressure Class	150
9. Temperature	-46°C to 340°C
10. Material Class	Low-Temperature Carbon Steel
11. Body Material	ASTM A350 Gr LF2 CL1
12. Obturator Material	AISI 316
13. Seat Material	AISI 316
14. Seat Insert Material	N/A
15. Spring Material	N/A
16. Stem Material	ASTM A276 (UNS S31600)
17. Stem Seal Material	Group F (acc. item A.7.1.5.6)
18. Operator Type	Lever
19. Additional Requirement	Fire Tested (acc. item A.6.1.4)
20. Seat Type	N/A
21. Bore Type	Full Bore
22. Body Construction	One piece forged body
23. Product Testing	FAT according A.9.3
24. Cladding or Coating	N/A
25. Notes	Needle valve between balls for cavity-pressure relief Max weight 55kg Minimum bore size 10mm

Valve Code	VDE-150-2-C215
Specs	B6
1. Valve Type	Double Ball
2. Sealing Type	Soft
3. Valve Specification Level (VSL)	VSL-2
4. Ball Mounting	Trunnion
5. Standard	API 6D
6. Size Range (NPS)	3" - 8"
7. End Connection	RF
8. Pressure Class	150
9. Temperature	-30°C to 150°C
10. Material Class	Low-Temperature Carbon Steel
11. Body Material	ASTM A350 Gr LF2 CL1 or ASTM A352 Gr LCC + SS316 weld overlay (acc. item A.7.1.7.3)
12. Obturator Material	AISI 316
13. Seat Material	AISI 410
14. Seat Insert Material	PEEK
15. Spring (Seat) Material	UNS N07750
16. Stem Material	ASTM A276 (UNS S31600)
17. Seat-Stem Seal	Group B (acc. item A.7.1.5.6)
18. Operator Type	3" - 4" Lever 4" - 8" Gearbox
19. Additional Requirement	Fire Tested (acc. item A.6.1.4)
20. Seat Type	(For trunnion-mounted) Side A: SPE / Side B: SPE; DDB
21. Bore Type	Full Bore
22. Body Construction	Compact flangeless single body double ball valve. Face to face according ASME B16.10
23. Cladding or Coating	Partial clad - SS316 weld overlay on all body sealing areas
24. Valve Testing	FAT according A.9.3
25. Notes	All materials described in this datasheet are required for both valve, Needle valve between balls for cavity-pressure relief

Valve Code	VDE-150-2-C21F
Specs	B6
1. Valve Type	Double Ball
2. Sealing Type	Soft
3. Valve Specification Level (VSL)	VSL-2
4. Ball Mounting	Trunnion
5. Standard	API 6D
6. Size Range (NPS)	3" - 8"
7. End Connection	RF
8. Pressure Class	150
9. Temperature	-30°C to 150°C
10. Material Class	Low-Temperature Carbon Steel
11. Body Material	ASTM A350 Gr LF2 CL1 or ASTM A352 Gr LCC + SS316 weld overlay (acc. item A.7.1.7.3)
12. Obturator Material	AISI 316
13. Seat Material	AISI 410
14. Seat Insert Material	PTFE reinforced with 25% Carbon
15. Spring (Seat) Material	UNS N07750
16. Stem Material	ASTM A276 (UNS S31600)
17. Seat-Stem Seal	Group B (acc. item A.7.1.5.6)
18. Operator Type	3" - 4" Lever 4" - 8" Gearbox
19. Additional Requirement	Fire Tested (acc. item A.6.1.4); Fugitive Emission (acc. item A.6.1.6)
20. Seat Type	(For trunnion-mounted) Side A: SPE / Side B: SPE
21. Bore Type	Full Bore
22. Body Construction	Compact flangeless single body double ball valve. Face to face according ASME B16.10
23. Cladding or Coating	Partial clad - SS316 weld overlay on all body sealing areas
24. Valve Testing	FAT according A.9.3
25. Notes	All materials described in this datasheet are required for both valve, Needle valve between balls for cavity-pressure relief



Valve Code	VDE-150-2-C235
Specs	B6
1. Valve Type	Double Ball
2. Sealing Type	Soft
3. Valve Specification Level (VSL)	VSL-2
4. Ball Mounting	Trunnion
5. Standard	API 6D
6. Size Range (NPS)	3" - 8"
7. End Connection	RF
8. Pressure Class	150
9. Temperature	-46°C to 150°C
10. Material Class	Low-Temperature Carbon Steel
11. Body Material	ASTM A350 Gr LF2 CL1 or ASTM A352 Gr LCC + SS316 weld overlay (acc. item A.7.1.7.3)
12. Obturator Material	AISI 316
13. Seat Material	AISI 410
14. Seat Insert Material	PEEK
15. Spring (Seat) Material	UNS N07750
16. Stem Material	ASTM A276 (UNS S31600)
17. Seat-Stem Seal	Group E (acc. item A.7.1.5.6)
18. Operator Type	3" - 8" Lever Gearbox
19. Additional Requirement	Fire Tested (acc. item A.6.1.4)
20. Seat Type	(For trunnion-mounted) Side A: SPE / Side B: SPE; DBB
21. Bore Type	Full Bore
22. Body Construction	Compact Flangeless single body double ball valve. Face to face according ASME B16.10
23. Cladding or Coating	Partial clad - SS316 weld overlay on all body sealing areas
24. Valve Testing	FAT according A.9.3
25. Notes	All materials described in this datasheet are required for both valve, Needle valve between balls for cavity-pressure relief

Valve Code	VDE-150-2-C2F1
Specs	B6
1. Valve Type	Double Ball
2. Sealing Type	Soft
3. Valve Specification Level (VSL)	VSL-2
4. Obturator Type	Floating
5. Standard	ASME B16.34
6. Size Range (NPS)	½" - 2"
7. End Connection	Flanged ASME B16.5, RF
8. Pressure Class	150
9. Temperature	-30°C to 150°C
10. Material Class	Low-Temperature Carbon Steel
11. Body Material	ASTM A350 Gr LF2 CL1
12. Obturator Material	AISI 316
13. Seat Material	PTFE reinforced with 25% Carbon
14. Seat Insert Material	N/A
15. Spring Material	N/A
16. Stem Material	ASTM A276 (UNS S31600)
17. Stem Seal Material	Group B (acc. item A.7.1.5.6)
18. Operator Type	Lever
19. Additional Requirement	Fire Tested (acc. item A.6.1.4); Fugitive Emission (acc. item A.6.1.6)
20. Seat Type	N/A
21. Bore Type	Full Bore
22. Body Construction	One piece forged body
23. Product Testing	FAT according A.9.3
24. Cladding or Coating	N/A
25. Notes	Needle valve between balls for cavity-pressure relief Max weight 55kg Minimum bore size 10mm

Valve Code	VDE-150-2-C2F2
Specs	B6
1. Valve Type	Double Ball
2. Sealing Type	Soft
3. Valve Specification Level (VSL)	VSL-2
4. Obturator Type	Floating
5. Standard	ASME B16.34
6. Size Range (NPS)	½" - 2"
7. End Connection	Flanged ASME B16.5, RF x NPT 1/2" ASME B1.20.1
8. Pressure Class	150
9. Temperature	-30°C to 150°C
10. Material Class	Low-Temperature Carbon Steel
11. Body Material	ASTM A350 Gr LF2 CL1
12. Obturator Material	AISI 316
13. Seat Material	PTFE reinforced with 25% Carbon
14. Seat Insert Material	N/A
15. Spring Material	N/A
16. Stem Material	ASTM A276 (UNS S31600)
17. Stem Seal Material	Group B (acc. item A.7.1.5.6)
18. Operator Type	Lever
19. Additional Requirement	Fire Tested (acc. item A.6.1.4); Fugitive Emission (acc. item A.6.1.6)
20. Seat Type	N/A
21. Bore Type	Full Bore
22. Body Construction	One piece forged body
23. Product Testing	FAT according A.9.3
24. Cladding or Coating	N/A
25. Notes	Needle valve between balls for cavity-pressure relief Max weight 55kg Minimum bore size 10mm

Valve Code	VDE-150-2-C2F3
Specs	B6
1. Valve Type	Double Ball
2. Sealing Type	Soft
3. Valve Specification Level (VSL)	VSL-2
4. Obturator Type	Floating
5. Standard	ASME B16.34
6. Size Range (NPS)	½" - 2"
7. End Connection	Flanged ASME B16.5, RF
8. Pressure Class	150
9. Temperature	-46°C to 150°C
10. Material Class	Low-Temperature Carbon Steel
11. Body Material	ASTM A350 Gr LF2 CL1
12. Obturator Material	AISI 316
13. Seat Material	PTFE reinforced with 25% Carbon
14. Seat Insert Material	N/A
15. Spring Material	N/A
16. Stem Material	ASTM A276 (UNS S31600)
17. Stem Seal Material	Group E (acc. item A.7.1.5.6)
18. Operator Type	Lever
19. Additional Requirement	Fire Tested (acc. item A.6.1.4); Fugitive Emission (acc. item A.6.1.6)
20. Seat Type	N/A
21. Bore Type	Full Bore
22. Body Construction	One piece forged body
23. Product Testing	FAT according A.9.3
24. Cladding or Coating	N/A
25. Notes	Needle valve between balls for cavity-pressure relief Max weight 55kg Minimum bore size 10mm

Valve Code	VDE-150-2-C2F4
Specs	B6
1. Valve Type	Double Ball
2. Sealing Type	Soft
3. Valve Specification Level (VSL)	VSL-2
4. Obturator Type	Floating
5. Standard	ASME B16.34
6. Size Range (NPS)	½" - 2"
7. End Connection	Flanged ASME B16.5, RF x NPT 1/2" ASME B1.20.1
8. Pressure Class	150
9. Temperature	-46°C to 150°C
10. Material Class	Low-Temperature Carbon Steel
11. Body Material	ASTM A350 Gr LF2 CL1
12. Obturator Material	AISI 316
13. Seat Material	PTFE reinforced with 25% Carbon
14. Seat Insert Material	N/A
15. Spring Material	N/A
16. Stem Material	ASTM A276 (UNS S31600)
17. Stem Seal Material	Group E (acc. item A.7.1.5.6)
18. Operator Type	Lever
19. Additional Requirement	Fire Tested (acc. item A.6.1.4); Fugitive Emission (acc. item A.6.1.6)
20. Seat Type	N/A
21. Bore Type	Full Bore
22. Body Construction	One piece forged body
23. Product Testing	FAT according A.9.3
24. Cladding or Coating	N/A
25. Notes	Needle valve between balls for cavity-pressure relief Max weight 55kg Minimum bore size 10mm

Valve Code	VDE-150-2-C2F5
Specs	B6
1. Valve Type	Double Ball
2. Sealing Type	Metal to Metal
3. Valve Specification Level (VSL)	VSL-2
4. Obturator Type	Floating
5. Standard	ASME B16.34
6. Size Range (NPS)	½" - 2"
7. End Connection	Flanged ASME B16.5, RF
8. Pressure Class	150
9. Temperature	-46°C to 200°C
10. Material Class	Low-Temperature Carbon Steel
11. Body Material	ASTM A350 Gr LF2 CL1
12. Obturator Material	AISI 316
13. Seat Material	AISI 316
14. Seat Insert Material	N/A
15. Spring Material	N/A
16. Stem Material	ASTM A276 (UNS S31600)
17. Stem Seal Material	Group E (acc. item A.7.1.5.6)
18. Operator Type	Lever
19. Additional Requirement	Fire Tested (acc. item A.6.1.4); Fugitive Emission (acc. item A.6.1.6)
20. Seat Type	N/A
21. Bore Type	Full Bore
22. Body Construction	One piece forged body
23. Product Testing	FAT according A.9.3
24. Cladding or Coating	N/A
25. Notes	Needle valve between balls for cavity-pressure relief Max weight 55kg Minimum bore size 10mm

Valve Code	VDE-150-2-C2F6
Specs	B6
1. Valve Type	Double Ball
2. Sealing Type	Metal to Metal
3. Valve Specification Level (VSL)	VSL-2
4. Obturator Type	Floating
5. Standard	ASME B16.34
6. Size Range (NPS)	½" - 2"
7. End Connection	Flanged ASME B16.5, RF x NPT 1/2" ASME B1.20.1
8. Pressure Class	150
9. Temperature	-46°C to 200°C
10. Material Class	Low-Temperature Carbon Steel
11. Body Material	ASTM A350 Gr LF2 CL1
12. Obturator Material	AISI 316
13. Seat Material	AISI 316
14. Seat Insert Material	N/A
15. Spring Material	N/A
16. Stem Material	ASTM A276 (UNS S31600)
17. Stem Seal Material	Group E (acc. item A.7.1.5.6)
18. Operator Type	Lever
19. Additional Requirement	Fire Tested (acc. item A.6.1.4); Fugitive Emission (acc. item A.6.1.6)
20. Seat Type	N/A
21. Bore Type	Full Bore
22. Body Construction	One piece forged body
23. Product Testing	FAT according A.9.3
24. Cladding or Coating	N/A
25. Notes	Needle valve between balls for cavity-pressure relief Max weight 55kg Minimum bore size 10mm

Valve Code	VDE-150-2-C2F7
Specs	B6
1. Valve Type	Double Ball
2. Sealing Type	Metal to Metal
3. Valve Specification Level (VSL)	VSL-2
4. Obturator Type	Floating
5. Standard	ASME B16.34
6. Size Range (NPS)	½" - 2"
7. End Connection	Flanged ASME B16.5, RF
8. Pressure Class	150
9. Temperature	-46°C to 340°C
10. Material Class	Low-Temperature Carbon Steel
11. Body Material	ASTM A350 Gr LF2 CL1
12. Obturator Material	AISI 316
13. Seat Material	AISI 316
14. Seat Insert Material	N/A
15. Spring Material	N/A
16. Stem Material	ASTM A276 (UNS S31600)
17. Stem Seal Material	Group F (acc. item A.7.1.5.6)
18. Operator Type	Lever
19. Additional Requirement	Fire Tested (acc. item A.6.1.4); Fugitive Emission (acc. item A.6.1.6)
20. Seat Type	N/A
21. Bore Type	Full Bore
22. Body Construction	One piece forged body
23. Product Testing	FAT according A.9.3
24. Cladding or Coating	N/A
25. Notes	Needle valve between balls for cavity-pressure relief Max weight 55kg Minimum bore size 10mm





Valve Code	VDE-150-2-C2F8
Specs	B6
1. Valve Type	Double Ball
2. Sealing Type	Metal to Metal
3. Valve Specification Level (VSL)	VSL-2
4. Obturator Type	Floating
5. Standard	ASME B16.34
6. Size Range (NPS)	½" - 2"
7. End Connection	Flanged ASME B16.5, RF x NPT 1/2" ASME B1.20.1
8. Pressure Class	150
9. Temperature	-46°C to 340°C
10. Material Class	Low-Temperature Carbon Steel
11. Body Material	ASTM A350 Gr LF2 CL1
12. Obturator Material	AISI 316
13. Seat Material	AISI 316
14. Seat Insert Material	N/A
15. Spring Material	N/A
16. Stem Material	ASTM A276 (UNS S31600)
17. Stem Seal Material	Group F (acc. item A.7.1.5.6)
18. Operator Type	Lever
19. Additional Requirement	Fire Tested (acc. item A.6.1.4); Fugitive Emission (acc. item A.6.1.6)
20. Seat Type	N/A
21. Bore Type	Full Bore
22. Body Construction	One piece forged body
23. Product Testing	FAT according A.9.3
24. Cladding or Coating	N/A
25. Notes	Needle valve between balls for cavity-pressure relief Max weight 55kg Minimum bore size 10mm

Valve Code	VDE-150-2-C511
Specs	B30
1. Valve Type	Double Ball
2. Sealing Type	Soft
3. Valve Specification Level (VSL)	VSL-2
4. Ball Mouting	Trunnion
5. Standard	API 6D
6. Size Range (NPS)	3" - 8"
7. End Connection	RF
8. Pressure Class	150
9. Temperature	-29°C to 150°C
10. Material Class	Carbon Steel
11. Body Material	ASTM A105 or ASTM A216 Gr WCB + Inconel 625 weld overlay (acc. item A.7.1.7.3)
12. Obturator Material	ASTM A105 + Inconel 625 weld overlay (acc. item A.7.1.7.3)
13. Seat Material	ASTM A105 + Inconel 625 weld overlay (acc. item A.7.1.7.3)
14. Seat Insert	PTFE reinforced with 25% Carbon
15. Spring (Seat) Material	UNS N07750
16. Stem Material	ASTM B637 (UNS N07718)
17. Seat-Stem Seal	Group B (acc. item A.7.1.5.6)
18. Operator Type	3" - 8" Lever 4" - 8" Gearbox
19. Additional Requirement	Fire Tested (acc. item A.6.1.4)
20. Seat Type	(For trunnion-mounted) Side A: SPE / Side B: SPE
21. Bore Type	Full Bore
22. Body Construction	Compact flangeless single body double ball valve. Face to face according ASME B16.10
23. Cladding or Coating	Full clad - Inconel 625 weld overlay on all wetted parts
24. Valve Testing	FAT according A.9.3
25. Notes	All materials described in this datasheet are required for both valve, Needle valve between balls for cavity-pressure relief

Valve Code	VDE-150-2-C51F
Specs	B30
1. Valve Type	Double Ball
2. Sealing Type	Soft
3. Valve Specification Level (VSL)	VSL-2
4. Ball Mouting	Trunnion
5. Standard	API 6D
6. Size Range (NPS)	3" - 8"
7. End Connection	RF
8. Pressure Class	150
9. Temperature	-29°C to 150°C
10. Material Class	Carbon Steel
11. Body Material	ASTM A105 or ASTM A216 Gr WCB + Inconel 625 weld overlay (acc. item A.7.1.7.3)
12. Obturator Material	ASTM A105 + Inconel 625 weld overlay (acc. item A.7.1.7.3)
13. Seat Material	ASTM A105 + Inconel 625 weld overlay (acc. item A.7.1.7.3)
14. Seat Insert	PTFE reinforced with 25% Carbon
15. Spring (Seat) Material	UNS N07750
16. Stem Material	ASTM B637 (UNS N07718)
17. Seat-Stem Seal	Group B (acc. item A.7.1.5.6)
18. Operator Type	3" - 8" Lever 4" - 8" Gearbox
19. Additional Requirement	Fire Tested (acc. item A.6.1.4); Fugitive Emission (acc. item A.6.1.6)
20. Seat Type	(For trunnion-mounted) Side A: SPE / Side B: SPE
21. Bore Type	Full Bore
22. Body Construction	Compact flangeless single body double ball valve. Face to face according ASME B16.10
23. Cladding or Coating	Full clad - Inconel 625 weld overlay on all wetted parts
24. Valve Testing	FAT according A.9.3
25. Notes	All materials described in this datasheet are required for both valve, Needle valve between balls for cavity-pressure relief

Valve Code	VDE-150-2-D201
Specs	B11 B16
1. Valve Type	Double Ball
2. Sealing Type	Soft
3. Valve Specification Level (VSL)	VSL-2
4. Obturator Type	Floating
5. Standard	ASME B16.34
6. Size Range (NPS)	½" - 2"
7. End Connection	Flanged ASME B16.5, RF
8. Pressure Class	150
9. Temperature	-30°C to 150°C
10. Material Class	Duplex Steel
11. Body Material	ASTM A182 Gr F51
12. Obturator Material	Duplex (UNS S31803)
13. Seat Material	PTFE reinforced with 25% Carbon
14. Seat Insert Material	N/A
15. Spring Material	N/A
16. Stem Material	ASTM A276 (UNS S31803)
17. Stem Seal Material	Group B (acc. item A.7.1.5.6)
18. Operator Type	Lever
19. Additional Requirement	Fire Tested (acc. item A.6.1.4)
20. Seat Type	N/A
21. Bore Type	Full Bore
22. Body Construction	One piece forged body
23. Product Testing	FAT according A.9.3
24. Cladding or Coating	N/A
25. Notes	Needle valve between balls for cavity-pressure relief Max weight 55kg Minimum bore size 10mm

Valve Code	VDE-150-2-D202
Specs	B11 B16
1. Valve Type	Double Ball
2. Sealing Type	Soft
3. Valve Specification Level (VSL)	VSL-2
4. Obturator Type	Floating
5. Standard	ASME B16.34
6. Size Range (NPS)	½" - 2"
7. End Connection	Flanged ASME B16.5, RF x NPT 1/2" ASME B1.20.1
8. Pressure Class	150
9. Temperature	-30°C to 150°C
10. Material Class	Duplex Steel
11. Body Material	ASTM A182 Gr F51
12. Obturator Material	Duplex (UNS S31803)
13. Seat Material	PTFE reinforced with 25% Carbon
14. Seat Insert Material	N/A
15. Spring Material	N/A
16. Stem Material	ASTM A276 (UNS S31803)
17. Stem Seal Material	Group B (acc. item A.7.1.5.6)
18. Operator Type	Lever
19. Additional Requirement	Fire Tested (acc. item A.6.1.4)
20. Seat Type	N/A
21. Bore Type	Full Bore
22. Body Construction	One piece forged body
23. Product Testing	FAT according A.9.3
24. Cladding or Coating	N/A
25. Notes	Needle valve between balls for cavity-pressure relief Max weight 55kg Minimum bore size 10mm

Valve Code	VDE-150-2-D203
Specs	B11 B16
1. Valve Type	Double Ball
2. Sealing Type	Soft
3. Valve Specification Level (VSL)	VSL-2
4. Obturator Type	Floating
5. Standard	ASME B16.34
6. Size Range (NPS)	½" - 2"
7. End Connection	Flanged ASME B16.5, RF
8. Pressure Class	150
9. Temperature	-46°C to 150°C
10. Material Class	Duplex Steel
11. Body Material	ASTM A182 Gr F51
12. Obturator Material	Duplex (UNS S31803)
13. Seat Material	PTFE reinforced with 25% Carbon
14. Seat Insert Material	N/A
15. Spring Material	N/A
16. Stem Material	ASTM A276 (UNS S31803)
17. Stem Seal Material	Group E (acc. item A.7.1.5.6)
18. Operator Type	Lever
19. Additional Requirement	Fire Tested (acc. item A.6.1.4)
20. Seat Type	N/A
21. Bore Type	Full Bore
22. Body Construction	One piece forged body
23. Product Testing	FAT according A.9.3
24. Cladding or Coating	N/A
25. Notes	Needle valve between balls for cavity-pressure relief Max weight 55kg Minimum bore size 10mm

Valve Code	VDE-150-2-D204
Specs	B11 B16
1. Valve Type	Double Ball
2. Sealing Type	Soft
3. Valve Specification Level (VSL)	VSL-2
4. Obturator Type	Floating
5. Standard	ASME B16.34
6. Size Range (NPS)	½" - 2"
7. End Connection	Flanged ASME B16.5, RF x NPT 1/2" ASME B1.20.1
8. Pressure Class	150
9. Temperature	-46°C to 150°C
10. Material Class	Duplex Steel
11. Body Material	ASTM A182 Gr F51
12. Obturator Material	Duplex (UNS S31803)
13. Seat Material	PTFE reinforced with 25% Carbon
14. Seat Insert Material	N/A
15. Spring Material	N/A
16. Stem Material	ASTM A276 (UNS S31803)
17. Stem Seal Material	Group E (acc. item A.7.1.5.6)
18. Operator Type	Lever
19. Additional Requirement	Fire Tested (acc. item A.6.1.4)
20. Seat Type	N/A
21. Bore Type	Full Bore
22. Body Construction	One piece forged body
23. Product Testing	FAT according A.9.3
24. Cladding or Coating	N/A
25. Notes	Needle valve between balls for cavity-pressure relief Max weight 55kg Minimum bore size 10mm

Valve Code	VDE-150-2-D2F1
Specs	B11 B16
1. Valve Type	Double Ball
2. Sealing Type	Soft
3. Valve Specification Level (VSL)	VSL-2
4. Obturator Type	Floating
5. Standard	ASME B16.34
6. Size Range (NPS)	1" - 2"
7. End Connection	Flanged ASME B16.5, RF
8. Pressure Class	150
9. Temperature	-30°C to 150°C
10. Material Class	Duplex Steel
11. Body Material	ASTM A182 Gr F51
12. Obturator Material	Duplex (UNS S31803)
13. Seat Material	PTFE reinforced with 25% Carbon
14. Seat Insert Material	N/A
15. Spring Material	N/A
16. Stem Material	ASTM A276 (UNS S31803)
17. Stem Seal Material	Group B (acc. item A.7.1.5.6)
18. Operator Type	Lever
19. Additional Requirement	Fire Tested (acc. item A.6.1.4); Fugitive Emission (acc. item A.6.1.6)
20. Seat Type	N/A
21. Bore Type	Full Bore
22. Body Construction	One piece forged body
23. Product Testing	FAT according A.9.3
24. Cladding or Coating	N/A
25. Notes	Needle valve between balls for cavity-pressure relief Max weight 55kg Minimum bore size 10mm

Valve Code	VDE-150-2-D2F2
Specs	B11 B16
1. Valve Type	Double Ball
2. Sealing Type	Soft
3. Valve Specification Level (VSL)	VSL-2
4. Obturator Type	Floating
5. Standard	ASME B16.34
6. Size Range (NPS)	1" - 2"
7. End Connection	Flanged ASME B16.5, RF x NPT 1/2" ASME B1.20.1
8. Pressure Class	150
9. Temperature	-30°C to 150°C
10. Material Class	Duplex Steel
11. Body Material	ASTM A182 Gr F51
12. Obturator Material	Duplex (UNS S31803)
13. Seat Material	PTFE reinforced with 25% Carbon
14. Seat Insert Material	N/A
15. Spring Material	N/A
16. Stem Material	ASTM A276 (UNS S31803)
17. Stem Seal Material	Group B (acc. item A.7.1.5.6)
18. Operator Type	Lever
19. Additional Requirement	Fire Tested (acc. item A.6.1.4); Fugitive Emission (acc. item A.6.1.6)
20. Seat Type	N/A
21. Bore Type	Full Bore
22. Body Construction	One piece forged body
23. Product Testing	FAT according A.9.3
24. Cladding or Coating	N/A
25. Notes	Needle valve between balls for cavity-pressure relief Max weight 55kg Minimum bore size 10mm

Valve Code	VDE-150-2-D2F3
Specs	B11 B16
1. Valve Type	Double Ball
2. Sealing Type	Soft
3. Valve Specification Level (VSL)	VSL-2
4. Obturator Type	Floating
5. Standard	ASME B16.34
6. Size Range (NPS)	1" - 2"
7. End Connection	Flanged ASME B16.5, RF
8. Pressure Class	150
9. Temperature	-46°C to 150°C
10. Material Class	Duplex Steel
11. Body Material	ASTM A182 Gr F51
12. Obturator Material	Duplex (UNS S31803)
13. Seat Material	PTFE reinforced with 25% Carbon
14. Seat Insert Material	N/A
15. Spring Material	N/A
16. Stem Material	ASTM A276 (UNS S31803)
17. Stem Seal Material	Group E (acc. item A.7.1.5.6)
18. Operator Type	Lever
19. Additional Requirement	Fire Tested (acc. item A.6.1.4); Fugitive Emission (acc. item A.6.1.6)
20. Seat Type	N/A
21. Bore Type	Full Bore
22. Body Construction	One piece forged body
23. Product Testing	FAT according A.9.3
24. Cladding or Coating	N/A
25. Notes	Needle valve between balls for cavity-pressure relief Max weight 55kg Minimum bore size 10mm

Valve Code	VDE-150-2-D2F4
Specs	B11 B16
1. Valve Type	Double Ball
2. Sealing Type	Soft
3. Valve Specification Level (VSL)	VSL-2
4. Obturator Type	Floating
5. Standard	ASME B16.34
6. Size Range (NPS)	1" - 2"
7. End Connection	Flanged ASME B16.5, RF x NPT 1/2" ASME B1.20.1
8. Pressure Class	150
9. Temperature	-46°C to 150°C
10. Material Class	Duplex Steel
11. Body Material	ASTM A182 Gr F51
12. Obturator Material	Duplex (UNS S31803)
13. Seat Material	PTFE reinforced with 25% Carbon
14. Seat Insert Material	N/A
15. Spring Material	N/A
16. Stem Material	ASTM A276 (UNS S31803)
17. Stem Seal Material	Group E (acc. item A.7.1.5.6)
18. Operator Type	Lever
19. Additional Requirement	Fire Tested (acc. item A.6.1.4); Fugitive Emission (acc. item A.6.1.6)
20. Seat Type	N/A
21. Bore Type	Full Bore
22. Body Construction	One piece forged body
23. Product Testing	FAT according A.9.3
24. Cladding or Coating	N/A
25. Notes	Needle valve between balls for cavity-pressure relief Max weight 55kg Minimum bore size 10mm

Valve Code	VDE-150-2-D301
Specs	B12
1. Valve Type	Double Ball
2. Sealing Type	Soft
3. Valve Specification Level (VSL)	VSL-2
4. Obturator Type	Floating
5. Standard	ASME B16.34
6. Size Range (NPS)	½" - 2"
7. End Connection	Flanged ASME B16.5, RF
8. Pressure Class	150
9. Temperature	-30°C to 150°C
10. Material Class	Duplex Steel
11. Body Material	ASTM A182 Gr F55
12. Obturator Material	Super Duplex (UNS S32760)
13. Seat Material	PTFE reinforced with 25% Carbon
14. Seat Insert Material	N/A
15. Spring Material	N/A
16. Stem Material	ASTM A276 (UNS S32760)
17. Stem Seal Material	Group B (acc. item A.7.1.5.6)
18. Operator Type	Lever
19. Additional Requirement	Fire Tested (acc. item A.6.1.4)
20. Seat Type	N/A
21. Bore Type	Full Bore
22. Body Construction	One piece forged body
23. Product Testing	FAT according A.9.3
24. Cladding or Coating	N/A
25. Notes	Needle valve between balls for cavity-pressure relief Max weight 55kg Minimum bore size 10mm





Valve Code	VDE-150-2-N1F2
Specs	B30
1. Valve Type	Double Ball
2. Sealing Type	Soft
3. Valve Specification Level (VSL)	VSL-2
4. Obturator Type	Floating
5. Standard	ASME B16.34
6. Size Range (NPS)	½" - 2"
7. End Connection	Flanged ASME B16.5, RF x NPT 1/2" ASME B1.20.1
8. Pressure Class	150
9. Temperature	-30°C to 150°C
10. Material Class	Nickel Alloys
11. Body Material	ASTM B564 (UNS N06625)
12. Obturator Material	ASTM B564 (UNS N06625)
13. Seat Material	PTFE reinforced with 25% Carbon
14. Seat Insert Material	N/A
15. Spring Material	N/A
16. Stem Material	ASTM B637 (UNS N07718)
17. Stem Seal Material	Group B (acc. item A.7.1.5.6)
18. Operator Type	Lever
19. Additional Requirement	Fire Tested (acc. item A.6.1.4); Fugitive Emission (acc. item A.6.1.6)
20. Seat Type	N/A
21. Bore Type	Full Bore
22. Body Construction	One piece forged body
23. Product Testing	FAT according A.9.3
24. Cladding or Coating	N/A
25. Notes	Needle valve between balls for cavity-pressure relief Max weight 55kg Minimum bore size 10mm

Valve Code	VDE-150-2-N1F5
Specs	B30
1. Valve Type	Double Ball
2. Sealing Type	Metal to Metal
3. Valve Specification Level (VSL)	VSL-2
4. Obturator Type	Floating
5. Standard	ASME B16.34
6. Size Range (NPS)	½" - 2"
7. End Connection	Flanged ASME B16.5, RF
8. Pressure Class	150
9. Temperature	-100°C to 200°C
10. Material Class	Nickel Alloys
11. Body Material	ASTM B564 (UNS N06625)
12. Obturator Material	ASTM B564 (UNS N06625)
13. Seat Material	ASTM B564 (UNS N06625)
14. Seat Insert Material	N/A
15. Spring Material	N/A
16. Stem Material	ASTM B637 (UNS N07718)
17. Stem Seal Material	Group E (acc. item A.7.1.5.6)
18. Operator Type	Lever
19. Additional Requirement	Fire Tested (acc. item A.6.1.4); Fugitive Emission (acc. item A.6.1.6)
20. Seat Type	N/A
21. Bore Type	Full Bore
22. Body Construction	One piece forged body
23. Product Testing	FAT according A.9.3
24. Cladding or Coating	N/A
25. Notes	Needle valve between balls for cavity-pressure relief Max weight 55kg Minimum bore size 10mm

Valve Code	VDE-150-2-N1F6
Specs	B30
1. Valve Type	Double Ball
2. Sealing Type	Metal to Metal
3. Valve Specification Level (VSL)	VSL-2
4. Obturator Type	Floating
5. Standard	ASME B16.34
6. Size Range (NPS)	½" - 2"
7. End Connection	Flanged ASME B16.5, RF x NPT 1/2" ASME B1.20.1
8. Pressure Class	150
9. Temperature	-100°C to 200°C
10. Material Class	Nickel Alloys
11. Body Material	ASTM B564 (UNS N06625)
12. Obturator Material	ASTM B564 (UNS N06625)
13. Seat Material	ASTM B564 (UNS N06625)
14. Seat Insert Material	N/A
15. Spring Material	N/A
16. Stem Material	ASTM B637 (UNS N07718)
17. Stem Seal Material	Group E (acc. item A.7.1.5.6)
18. Operator Type	Lever
19. Additional Requirement	Fire Tested (acc. item A.6.1.4); Fugitive Emission (acc. item A.6.1.6)
20. Seat Type	N/A
21. Bore Type	Full Bore
22. Body Construction	One piece forged body
23. Product Testing	FAT according A.9.3
24. Cladding or Coating	N/A
25. Notes	Needle valve between balls for cavity-pressure relief Max weight 55kg Minimum bore size 10mm

Valve Code	VDE-150-2-S201
Specs	B3
1. Valve Type	Double Ball
2. Sealing Type	Soft
3. Valve Specification Level (VSL)	VSL-2
4. Obturator Type	Floating
5. Standard	ASME B16.34
6. Size Range (NPS)	½" - 2"
7. End Connection	Flanged ASME B16.5, RF
8. Pressure Class	150
9. Temperature	-30°C to 150°C
10. Material Class	Stainless Steel
11. Body Material	ASTM A182 Gr F316
12. Obturator Material	AISI 316
13. Seat Material	PTFE reinforced with 25% Carbon
14. Seat Insert Material	N/A
15. Spring Material	N/A
16. Stem Material	ASTM A276 (UNS S31600)
17. Stem Seal Material	Group B (acc. item A.7.1.5.6)
18. Operator Type	Lever
19. Additional Requirement	Fire Tested (acc. item A.6.1.4)
20. Seat Type	N/A
21. Bore Type	Full Bore
22. Body Construction	One piece forged body
23. Product Testing	FAT according A.9.3
24. Cladding or Coating	N/A
25. Notes	Needle valve between balls for cavity-pressure relief Max weight 55kg Minimum bore size 10mm

Valve Code	VDE-150-2-S202
Specs	B3
1. Valve Type	Double Ball
2. Sealing Type	Soft
3. Valve Specification Level (VSL)	VSL-2
4. Obturator Type	Floating
5. Standard	ASME B16.34
6. Size Range (NPS)	½" - 2"
7. End Connection	Flanged ASME B16.5, RF x NPT 1/2" ASME B1.20.1
8. Pressure Class	150
9. Temperature	-30°C to 150°C
10. Material Class	Stainless Steel
11. Body Material	ASTM A182 Gr F316
12. Obturator Material	AISI 316
13. Seat Material	PTFE reinforced with 25% Carbon
14. Seat Insert Material	N/A
15. Spring Material	N/A
16. Stem Material	ASTM A276 (UNS S31600)
17. Stem Seal Material	Group B (acc. item A.7.1.5.6)
18. Operator Type	Lever
19. Additional Requirement	Fire Tested (acc. item A.6.1.4)
20. Seat Type	N/A
21. Bore Type	Full Bore
22. Body Construction	One piece forged body
23. Product Testing	FAT according A.9.3
24. Cladding or Coating	N/A
25. Notes	Needle valve between balls for cavity-pressure relief Max weight 55kg Minimum bore size 10mm

Valve Code	VDE-150-2-S203
Specs	B3
1. Valve Type	Double Ball
2. Sealing Type	Soft
3. Valve Specification Level (VSL)	VSL-2
4. Obturator Type	Floating
5. Standard	ASME B16.34
6. Size Range (NPS)	½" - 2"
7. End Connection	Flanged ASME B16.5, RF
8. Pressure Class	150
9. Temperature	-100°C to 150°C
10. Material Class	Stainless Steel
11. Body Material	ASTM A182 Gr F316
12. Obturator Material	AISI 316
13. Seat Material	PTFE reinforced with 25% Carbon
14. Seat Insert Material	N/A
15. Spring Material	N/A
16. Stem Material	ASTM A276 (UNS S31600)
17. Stem Seal Material	Group E (acc. item A.7.1.5.6)
18. Operator Type	Lever
19. Additional Requirement	Fire Tested (acc. item A.6.1.4)
20. Seat Type	N/A
21. Bore Type	Full Bore
22. Body Construction	One piece forged body
23. Product Testing	FAT according A.9.3
24. Cladding or Coating	N/A
25. Notes	Needle valve between balls for cavity-pressure relief Max weight 55kg Minimum bore size 10mm

Valve Code	VDE-150-2-S204
Specs	B3
1. Valve Type	Double Ball
2. Sealing Type	Soft
3. Valve Specification Level (VSL)	VSL-2
4. Obturator Type	Floating
5. Standard	ASME B16.34
6. Size Range (NPS)	½" - 2"
7. End Connection	Flanged ASME B16.5, RF x NPT 1/2" ASME B1.20.1
8. Pressure Class	150
9. Temperature	-100°C to 150°C
10. Material Class	Stainless Steel
11. Body Material	ASTM A182 Gr F316
12. Obturator Material	AISI 316
13. Seat Material	PTFE reinforced with 25% Carbon
14. Seat Insert Material	N/A
15. Spring Material	N/A
16. Stem Material	ASTM A276 (UNS S31600)
17. Stem Seal Material	Group E (acc. item A.7.1.5.6)
18. Operator Type	Lever
19. Additional Requirement	Fire Tested (acc. item A.6.1.4)
20. Seat Type	N/A
21. Bore Type	Full Bore
22. Body Construction	One piece forged body
23. Product Testing	FAT according A.9.3
24. Cladding or Coating	N/A
25. Notes	Needle valve between balls for cavity-pressure relief Max weight 55kg Minimum bore size 10mm

Valve Code	VDE-150-2-S205
Specs	B3
1. Valve Type	Double Ball
2. Sealing Type	Metal to Metal
3. Valve Specification Level (VSL)	VSL-2
4. Obturator Type	Floating
5. Standard	ASME B16.34
6. Size Range (NPS)	½" - 2"
7. End Connection	Flanged ASME B16.5, RF
8. Pressure Class	150
9. Temperature	-100°C to 200°C
10. Material Class	Stainless Steel
11. Body Material	ASTM A182 Gr F316
12. Obturator Material	AISI 316
13. Seat Material	AISI 316
14. Seat Insert Material	N/A
15. Spring Material	N/A
16. Stem Material	ASTM A276 (UNS S31600)
17. Stem Seal Material	Group E (acc. item A.7.1.5.6)
18. Operator Type	Lever
19. Additional Requirement	Fire Tested (acc. item A.6.1.4)
20. Seat Type	N/A
21. Bore Type	Full Bore
22. Body Construction	One piece forged body
23. Product Testing	FAT according A.9.3
24. Cladding or Coating	N/A
25. Notes	Needle valve between balls for cavity-pressure relief Max weight 55kg Minimum bore size 10mm

Valve Code	VDE-150-2-S206
Specs	B3
1. Valve Type	Double Ball
2. Sealing Type	Metal to Metal
3. Valve Specification Level (VSL)	VSL-2
4. Obturator Type	Floating
5. Standard	ASME B16.34
6. Size Range (NPS)	½" - 2"
7. End Connection	Flanged ASME B16.5, RF x NPT 1/2" ASME B1.20.1
8. Pressure Class	150
9. Temperature	-100°C to 200°C
10. Material Class	Stainless Steel
11. Body Material	ASTM A182 Gr F316
12. Obturator Material	AISI 316
13. Seat Material	AISI 316
14. Seat Insert Material	N/A
15. Spring Material	N/A
16. Stem Material	ASTM A276 (UNS S31600)
17. Stem Seal Material	Group E (acc. item A.7.1.5.6)
18. Operator Type	Lever
19. Additional Requirement	Fire Tested (acc. item A.6.1.4)
20. Seat Type	N/A
21. Bore Type	Full Bore
22. Body Construction	One piece forged body
23. Product Testing	FAT according A.9.3
24. Cladding or Coating	N/A
25. Notes	Needle valve between balls for cavity-pressure relief Max weight 55kg Minimum bore size 10mm

Valve Code	VDE-150-2-S207
Specs	B3
1. Valve Type	Double Ball
2. Sealing Type	Metal to Metal
3. Valve Specification Level (VSL)	VSL-2
4. Obturator Type	Floating
5. Standard	ASME B16.34
6. Size Range (NPS)	½" - 2"
7. End Connection	Flanged ASME B16.5, RF
8. Pressure Class	150
9. Temperature	-100°C to 340°C
10. Material Class	Stainless Steel
11. Body Material	ASTM A182 Gr F316
12. Obturator Material	AISI 316
13. Seat Material	AISI 316
14. Seat Insert Material	N/A
15. Spring Material	N/A
16. Stem Material	ASTM A276 (UNS S31600)
17. Stem Seal Material	Group F (acc. item A.7.1.5.6)
18. Operator Type	Lever
19. Additional Requirement	Fire Tested (acc. item A.6.1.4)
20. Seat Type	N/A
21. Bore Type	Full Bore
22. Body Construction	One piece forged body
23. Product Testing	FAT according A.9.3
24. Cladding or Coating	N/A
25. Notes	Needle valve between balls for cavity-pressure relief Max weight 55kg Minimum bore size 10mm

Valve Code	VDE-150-2-S208
Specs	B3
1. Valve Type	Double Ball
2. Sealing Type	Metal to Metal
3. Valve Specification Level (VSL)	VSL-2
4. Obturator Type	Floating
5. Standard	ASME B16.34
6. Size Range (NPS)	½" - 2"
7. End Connection	Flanged ASME B16.5, RF x NPT 1/2" ASME B1.20.1
8. Pressure Class	150
9. Temperature	-100°C to 340°C
10. Material Class	Stainless Steel
11. Body Material	ASTM A182 Gr F316
12. Obturator Material	AISI 316
13. Seat Material	AISI 316
14. Seat Insert Material	N/A
15. Spring Material	N/A
16. Stem Material	ASTM A276 (UNS S31600)
17. Stem Seal Material	Group F (acc. item A.7.1.5.6)
18. Operator Type	Lever
19. Additional Requirement	Fire Tested (acc. item A.6.1.4)
20. Seat Type	N/A
21. Bore Type	Full Bore
22. Body Construction	One piece forged body
23. Product Testing	FAT according A.9.3
24. Cladding or Coating	N/A
25. Notes	Needle valve between balls for cavity-pressure relief Max weight 55kg Minimum bore size 10mm

Valve Code	VDE-150-2-S271
Specs	B3
1. Valve Type	Double Ball
2. Sealing Type	Metal to Metal
3. Valve Specification Level (VSL)	VSL-2
4. Ball Mounting	Trunnion
5. Standard	API 6D
6. Size Range (NPS)	3" - 8"
7. End Connection	RF
8. Pressure Class	150
9. Temperature	-100°C to 200°C
10. Material Class	Stainless Steel
11. Body Material	ASTM A182 Gr F316 or ASTM A351 Gr CF8M + Inconel 625 weld overlay (acc. item A.7.1.7.3)
12. Obturator Material	AISI 316
13. Seat Material	AISI 316
14. Seat Insert Material	N/A
15. Spring (Seat) Material	UNS N07750
16. Stem Material	ASTM A276 (UNS S31600)
17. Seat-Stem Seal	Group E (acc. item A.7.1.5.6)
18. Operator Type	3" Lever 4" - 8" Gearbox
19. Additional Requirement	Fire Tested (acc. item A.6.1.4)
20. Seat Type	(For trunnion-mounted) Side A: SPE / Side B: SPE
21. Bore Type	Full Bore
22. Body Construction	Compact flangeless single body double ball valve. Face to face according ASME B16.10
23. Cladding or Coating	Partial clad - Inconel 625 weld overlay on all body sealing areas
24. Valve Testing	FAT according A.9.3
25. Notes	All materials described in this datasheet are required for both valve, Needle valve between balls for cavity-pressure relief



Valve Code	VDE-150-2-S2F1
Specs	B3
1. Valve Type	Double Ball
2. Sealing Type	Soft
3. Valve Specification Level (VSL)	VSL-2
4. Obturator Type	Floating
5. Standard	ASME B16.34
6. Size Range (NPS)	½" - 2"
7. End Connection	Flanged ASME B16.5, RF
8. Pressure Class	150
9. Temperature	-30°C to 150°C
10. Material Class	Stainless Steel
11. Body Material	ASTM A182 Gr F316
12. Obturator Material	AISI 316
13. Seat Material	PTFE reinforced with 25% Carbon
14. Seat Insert Material	N/A
15. Spring Material	N/A
16. Stem Material	ASTM A276 (UNS S31600)
17. Stem Seal Material	Group B (acc. item A.7.1.5.6)
18. Operator Type	Lever
19. Additional Requirement	Fire Tested (acc. item A.6.1.4); Fugitive Emission (acc. item A.6.1.6)
20. Seat Type	N/A
21. Bore Type	Full Bore
22. Body Construction	One piece forged body
23. Product Testing	FAT according A.9.3
24. Cladding or Coating	N/A
25. Notes	Needle valve between balls for cavity-pressure relief Max weight 55kg Minimum bore size 10mm

Valve Code	VDE-150-2-S2F2
Specs	B3
1. Valve Type	Double Ball
2. Sealing Type	Soft
3. Valve Specification Level (VSL)	VSL-2
4. Obturator Type	Floating
5. Standard	ASME B16.34
6. Size Range (NPS)	½" - 2"
7. End Connection	Flanged ASME B16.5, RF x NPT 1/2" ASME B1.20.1
8. Pressure Class	150
9. Temperature	-30°C to 150°C
10. Material Class	Stainless Steel
11. Body Material	ASTM A182 Gr F316
12. Obturator Material	AISI 316
13. Seat Material	PTFE reinforced with 25% Carbon
14. Seat Insert Material	N/A
15. Spring Material	N/A
16. Stem Material	ASTM A276 (UNS S31600)
17. Stem Seal Material	Group B (acc. item A.7.1.5.6)
18. Operator Type	Lever
19. Additional Requirement	Fire Tested (acc. item A.6.1.4); Fugitive Emission (acc. item A.6.1.6)
20. Seat Type	N/A
21. Bore Type	Full Bore
22. Body Construction	One piece forged body
23. Product Testing	FAT according A.9.3
24. Cladding or Coating	N/A
25. Notes	Needle valve between balls for cavity-pressure relief Max weight 55kg Minimum bore size 10mm

Valve Code	VDE-150-2-S2F3
Specs	B3
1. Valve Type	Double Ball
2. Sealing Type	Soft
3. Valve Specification Level (VSL)	VSL-2
4. Obturator Type	Floating
5. Standard	ASME B16.34
6. Size Range (NPS)	½" - 2"
7. End Connection	Flanged ASME B16.5, RF
8. Pressure Class	150
9. Temperature	-100°C to 150°C
10. Material Class	Stainless Steel
11. Body Material	ASTM A182 Gr F316
12. Obturator Material	AISI 316
13. Seat Material	PTFE reinforced with 25% Carbon
14. Seat Insert Material	N/A
15. Spring Material	N/A
16. Stem Material	ASTM A276 (UNS S31600)
17. Stem Seal Material	Group E (acc. item A.7.1.5.6)
18. Operator Type	Lever
19. Additional Requirement	Fire Tested (acc. item A.6.1.4); Fugitive Emission (acc. item A.6.1.6)
20. Seat Type	N/A
21. Bore Type	Full Bore
22. Body Construction	One piece forged body
23. Product Testing	FAT according A.9.3
24. Cladding or Coating	N/A
25. Notes	Needle valve between balls for cavity-pressure relief Max weight 55kg Minimum bore size 10mm

Valve Code	VDE-150-2-S2F4
Specs	B3
1. Valve Type	Double Ball
2. Sealing Type	Soft
3. Valve Specification Level (VSL)	VSL-2
4. Obturator Type	Floating
5. Standard	ASME B16.34
6. Size Range (NPS)	½" - 2"
7. End Connection	Flanged ASME B16.5, RF x NPT 1/2" ASME B1.20.1
8. Pressure Class	150
9. Temperature	-100°C to 150°C
10. Material Class	Stainless Steel
11. Body Material	ASTM A182 Gr F316
12. Obturator Material	AISI 316
13. Seat Material	PTFE reinforced with 25% Carbon
14. Seat Insert Material	N/A
15. Spring Material	N/A
16. Stem Material	ASTM A276 (UNS S31600)
17. Stem Seal Material	Group E (acc. item A.7.1.5.6)
18. Operator Type	Lever
19. Additional Requirement	Fire Tested (acc. item A.6.1.4); Fugitive Emission (acc. item A.6.1.6)
20. Seat Type	N/A
21. Bore Type	Full Bore
22. Body Construction	One piece forged body
23. Product Testing	FAT according A.9.3
24. Cladding or Coating	N/A
25. Notes	Needle valve between balls for cavity-pressure relief Max weight 55kg Minimum bore size 10mm

Valve Code	VDE-150-2-S2F5
Specs	B3
1. Valve Type	Double Ball
2. Sealing Type	Metal to Metal
3. Valve Specification Level (VSL)	VSL-2
4. Obturator Type	Floating
5. Standard	ASME B16.34
6. Size Range (NPS)	½" - 2"
7. End Connection	Flanged ASME B16.5, RF
8. Pressure Class	150
9. Temperature	-100°C to 200°C
10. Material Class	Stainless Steel
11. Body Material	ASTM A182 Gr F316
12. Obturator Material	AISI 316
13. Seat Material	AISI 316
14. Seat Insert Material	N/A
15. Spring Material	N/A
16. Stem Material	ASTM A276 (UNS S31600)
17. Stem Seal Material	Group E (acc. item A.7.1.5.6)
18. Operator Type	Lever
19. Additional Requirement	Fire Tested (acc. item A.6.1.4); Fugitive Emission (acc. item A.6.1.6)
20. Seat Type	N/A
21. Bore Type	Full Bore
22. Body Construction	One piece forged body
23. Product Testing	FAT according A.9.3
24. Cladding or Coating	N/A
25. Notes	Needle valve between balls for cavity-pressure relief Max weight 55kg Minimum bore size 10mm

Valve Code	VDE-150-2-S2F6
Specs	B3
1. Valve Type	Double Ball
2. Sealing Type	Metal to Metal
3. Valve Specification Level (VSL)	VSL-2
4. Obturator Type	Floating
5. Standard	ASME B16.34
6. Size Range (NPS)	½" - 2"
7. End Connection	Flanged ASME B16.5, RF x NPT 1/2" ASME B1.20.1
8. Pressure Class	150
9. Temperature	-100°C to 200°C
10. Material Class	Stainless Steel
11. Body Material	ASTM A182 Gr F316
12. Obturator Material	AISI 316
13. Seat Material	AISI 316
14. Seat Insert Material	N/A
15. Spring Material	N/A
16. Stem Material	ASTM A276 (UNS S31600)
17. Stem Seal Material	Group E (acc. item A.7.1.5.6)
18. Operator Type	Lever
19. Additional Requirement	Fire Tested (acc. item A.6.1.4); Fugitive Emission (acc. item A.6.1.6)
20. Seat Type	N/A
21. Bore Type	Full Bore
22. Body Construction	One piece forged body
23. Product Testing	FAT according A.9.3
24. Cladding or Coating	N/A
25. Notes	Needle valve between balls for cavity-pressure relief Max weight 55kg Minimum bore size 10mm

Valve Code	VDE-150-2-S2F7
Specs	B3
1. Valve Type	Double Ball
2. Sealing Type	Metal to Metal
3. Valve Specification Level (VSL)	VSL-2
4. Obturator Type	Floating
5. Standard	ASME B16.34
6. Size Range (NPS)	½" - 2"
7. End Connection	Flanged ASME B16.5, RF
8. Pressure Class	150
9. Temperature	-100°C to 340°C
10. Material Class	Stainless Steel
11. Body Material	ASTM A182 Gr F316
12. Obturator Material	AISI 316
13. Seat Material	AISI 316
14. Seat Insert Material	N/A
15. Spring Material	N/A
16. Stem Material	ASTM A276 (UNS S31600)
17. Stem Seal Material	Group F (acc. item A.7.1.5.6)
18. Operator Type	Lever
19. Additional Requirement	Fire Tested (acc. item A.6.1.4); Fugitive Emission (acc. item A.6.1.6)
20. Seat Type	N/A
21. Bore Type	Full Bore
22. Body Construction	One piece forged body
23. Product Testing	FAT according A.9.3
24. Cladding or Coating	N/A
25. Notes	Needle valve between balls for cavity-pressure relief Max weight 55kg Minimum bore size 10mm

Valve Code	VDE-150-2-S2F8
Specs	B3
1. Valve Type	Double Ball
2. Sealing Type	Metal to Metal
3. Valve Specification Level (VSL)	VSL-2
4. Obturator Type	Floating
5. Standard	ASME B16.34
6. Size Range (NPS)	½" - 2"
7. End Connection	Flanged ASME B16.5, RF x NPT 1/2" ASME B1.20.1
8. Pressure Class	150
9. Temperature	-100°C to 340°C
10. Material Class	Stainless Steel
11. Body Material	ASTM A182 Gr F316
12. Obturator Material	AISI 316
13. Seat Material	AISI 316
14. Seat Insert Material	N/A
15. Spring Material	N/A
16. Stem Material	ASTM A276 (UNS S31600)
17. Stem Seal Material	Group F (acc. item A.7.1.5.6)
18. Operator Type	Lever
19. Additional Requirement	Fire Tested (acc. item A.6.1.4); Fugitive Emission (acc. item A.6.1.6)
20. Seat Type	N/A
21. Bore Type	Full Bore
22. Body Construction	One piece forged body
23. Product Testing	FAT according A.9.3
24. Cladding or Coating	N/A
25. Notes	Needle valve between balls for cavity-pressure relief Max weight 55kg Minimum bore size 10mm

Valve Code	VDE-2510-2-C515
Specs	H30
1. Valve Type	Double Ball
2. Sealing Type	Soft
3. Valve Specification Level (VSL)	VSL-2
4. Ball Mounting	Trunnion
5. Standard	API 6D
6. Size Range (NPS)	3" - 8"
7. End Connection	ISO 27509, IX
8. Pressure Class	2500
9. Temperature	-29°C to 150°C
10. Material Class	Carbon Steel
11. Body Material	ASTM A105 + Inconel 625 weld overlay (acc. item A.7.1.7.3)
12. Obturator Material	ASTM A105 + Inconel 625 weld overlay (acc. item A.7.1.7.3)
13. Seat Material	ASTM A105 + Inconel 625 weld overlay (acc. item A.7.1.7.3)
14. Seat Insert Material	PEEK
15. Spring (Seat) Material	UNS N07750
16. Stem Material	ASTM B637 (UNS N07718)
17. Seat-Stem Seal	Group B (acc. item A.7.1.5.6)
18. Operator Type	Gearbox
19. Additional Requirement	Fire Tested (acc. item A.6.1.4)
20. Seat Type	(For trunnion-mounted) Side A: SPE / Side B: SPE; DBB
21. Bore Type	Full Bore
22. Body Construction	Compact flangeless single body double ball valve. Face to face according ASME B16.10
23. Cladding or Coating	Full clad - Inconel 625 weld overlay on all wetted parts
24. Valve Testing	FAT according A.9.3
25. Notes	All materials described in this datasheet are required for both valve, Needle valve between balls for cavity-pressure relief

Valve Code	VDE-2510-2-C51F
Specs	H30
1. Valve Type	Double Ball
2. Sealing Type	Soft
3. Valve Specification Level (VSL)	VSL-2
4. Ball Mounting	Trunnion
5. Standard	API 6D
6. Size Range (NPS)	3" - 8"
7. End Connection	ISO 27509, IX
8. Pressure Class	2500
9. Temperature	-29°C to 150°C
10. Material Class	Carbon Steel
11. Body Material	ASTM A105 + Inconel 625 weld overlay (acc. item A.7.1.7.3)
12. Obturator Material	ASTM A105 + Inconel 625 weld overlay (acc. item A.7.1.7.3)
13. Seat Material	ASTM A105 + Inconel 625 weld overlay (acc. item A.7.1.7.3)
14. Seat Insert Material	PEEK
15. Spring (Seat) Material	UNS N07750
16. Stem Material	ASTM B637 (UNS N07718)
17. Seat-Stem Seal	Group B (acc. item A.7.1.5.6)
18. Operator Type	Gearbox
19. Additional Requirement	Fire Tested (acc. item A.6.1.4); Fugitive Emission (acc. item A.6.1.6)
20. Seat Type	(For trunnion-mounted) Side A: SPE / Side B: SPE; DBB
21. Bore Type	Full Bore
22. Body Construction	Compact flangeless single body double ball valve. Face to face according ASME B16.10
23. Cladding or Coating	Full clad - Inconel 625 weld overlay on all wetted parts
24. Valve Testing	FAT according A.9.3
25. Notes	All materials described in this datasheet are required for both valve, Needle valve between balls for cavity-pressure relief

Valve Code	VDE-2510-2-D301
Specs	H12P H12
1. Valve Type	Double Ball
2. Sealing Type	Soft
3. Valve Specification Level (VSL)	VSL-2
4. Obturator Type	Trunnion
5. Standard	ASME B16.34
6. Size Range (NPS)	1" - 2"
7. End Connection	Flanged ASME B16.5, RTJ
8. Pressure Class	2500
9. Temperature	-30°C to 150°C
10. Material Class	Duplex Steel
11. Body Material	ASTM A182 Gr F55
12. Obturator Material	Super Duplex (UNS S32760)
13. Seat Material	Super Duplex (UNS S32760)
14. Seat Insert Material	PEEK
15. Spring Material	UNS N07750
16. Stem Material	ASTM A276 (UNS S32760)
17. Stem Seal Material	Group B (acc. item A.7.1.5.6)
18. Operator Type	Lever
19. Additional Requirement	Fire Tested (acc. item A.6.1.4)
20. Seat Type	(For trunnion-mounted) Side A: SPE / Side B: SPE
21. Bore Type	Full Bore
22. Body Construction	One piece forged body
23. Product Testing	FAT according A.9.3
24. Cladding or Coating	N/A
25. Notes	Needle valve between balls for cavity-pressure relief Max weight 55kg Minimum bore size 10mm

Valve Code	VDE-2510-2-D303
Specs	H12P
1. Valve Type	Double Ball
2. Sealing Type	Soft
3. Valve Specification Level (VSL)	VSL-2
4. Obturator Type	Trunnion
5. Standard	ASME B16.34
6. Size Range (NPS)	1" - 2"
7. End Connection	Compact Flange ISO 27509 IX Ring
8. Pressure Class	2500
9. Temperature	-46°C to 150°C
10. Material Class	Duplex Steel
11. Body Material	ASTM A182 Gr F55
12. Obturator Material	Super Duplex (UNS S32760)
13. Seat Material	Super Duplex (UNS S32760)
14. Seat Insert Material	PEEK
15. Spring Material	UNS N07750
16. Stem Material	ASTM A276 (UNS S32760)
17. Stem Seal Material	Group E (acc. item A.7.1.5.6)
18. Operator Type	Lever
19. Additional Requirement	Fire Tested (acc. item A.6.1.4)
20. Seat Type	(For trunnion-mounted) Side A: SPE / Side B: SPE
21. Bore Type	Full Bore
22. Body Construction	One piece forged body
23. Product Testing	FAT according A.9.3
24. Cladding or Coating	N/A
25. Notes	Needle valve between balls for cavity-pressure relief Max weight 55kg Minimum bore size 10mm









Valve Code	VDE-2510-2-S2F4
Specs	H3
1. Valve Type	Double Ball
2. Sealing Type	Soft
3. Valve Specification Level (VSL)	VSL-2
4. Obturator Type	Trunnion
5. Standard	ASME B16.34
6. Size Range (NPS)	1" - 2"
7. End Connection	Compact Flange ISO 27509 IX x FNPT 1/2" ASME B1.20.1
8. Pressure Class	2500
9. Temperature	-46°C to 150°C
10. Material Class	Stainless Steel
11. Body Material	ASTM A182 Gr F316/316L
12. Obturator Material	AISI 316
13. Seat Material	AISI 316
14. Seat Insert Material	PEEK
15. Spring Material	UNS N07750
16. Stem Material	ASTM B637 (UNS N07718)
17. Stem Seal Material	Group E (acc. item A.7.1.5.6)
18. Operator Type	Lever
19. Additional Requirement	Fire Tested (acc. item A.6.1.4); Fugitive Emission (acc. item A.6.1.6)
20. Seat Type	(For trunnion-mounted) Side A: SPE / Side B: SPE
21. Bore Type	Full Bore
22. Body Construction	One piece forged body
23. Product Testing	FAT according A.9.3
24. Cladding or Coating	N/A
25. Notes	Needle valve between balls for cavity-pressure relief Max weight 55kg Minimum bore size 10mm

Valve Code	VDE-2510-2-S2F5
Specs	H3
1. Valve Type	Double Ball
2. Sealing Type	Metal to Metal
3. Valve Specification Level (VSL)	VSL-2
4. Obturator Type	Trunnion
5. Standard	ASME B16.34
6. Size Range (NPS)	1" - 2"
7. End Connection	Compact Flange ISO 27509 IX Ring
8. Pressure Class	2500
9. Temperature	-100°C to 150°C
10. Material Class	Stainless Steel
11. Body Material	ASTM A182 Gr F316/316L
12. Obturator Material	AISI 316
13. Seat Material	AISI 316
14. Seat Insert Material	N/A
15. Spring Material	UNS N07750
16. Stem Material	ASTM B637 (UNS N07718)
17. Stem Seal Material	Group E (acc. item A.7.1.5.6)
18. Operator Type	Lever
19. Additional Requirement	Fire Tested (acc. item A.6.1.4); Fugitive Emission (acc. item A.6.1.6)
20. Seat Type	(For trunnion-mounted) Side A: SPE / Side B: SPE
21. Bore Type	Full Bore
22. Body Construction	One piece forged body
23. Product Testing	FAT according A.9.3
24. Cladding or Coating	N/A
25. Notes	Needle valve between balls for cavity-pressure relief Max weight 55kg Minimum bore size 10mm

Valve Code	VDE-2510-3-D37F
Specs	H12
1. Valve Type	Double Ball
2. Sealing Type	Metal to Metal
3. Valve Specification Level (VSL)	VSL-3
4. Ball Mouting	Trunnion
5. Standard	API 6D
6. Size Range (NPS)	3" - 8"
7. End Connection	ISO 27509, IX
8. Pressure Class	2500
9. Temperature	-50°C to 200°C
10. Material Class	Duplex Steel
11. Body Material	ASTM A182 Gr F55
12. Obturator Material	Super Duplex (UNS S32760)
13. Seat Material	Super Duplex (UNS S32760)
14. Seat Insert	N/A
15. Spring (Seat) Material	UNS N07750
16. Stem Material	ASTM A276 (UNS S32760)
17. Seat-Stem Seal	Group E (acc. item A.7.1.5.6)
18. Operator Type	Gearbox
19. Additional Requirement	Fire Tested (acc. item A.6.1.4); Fugitive Emission (acc. item A.6.1.6)
20. Seat Type	(For trunnion-mounted) Side A: SPE / Side B: SPE
21. Bore Type	Full Bore
22. Body Construction	Compact flangeless single body double ball valve. Face to face according ASME B16.10
23. Cladding or Coating	N/A
24. Valve Testing	FAT according A.9.3
25. Notes	All materials described in this datasheet are required for both valve, Needle valve between balls for cavity-pressure relief

Valve Code	VDE-2510-3-D37G
Specs	H12P
1. Valve Type	Double Ball
2. Sealing Type	Metal to Metal
3. Valve Specification Level (VSL)	VSL-3
4. Ball Mouting	Trunnion
5. Standard	API 6D
6. Size Range (NPS)	3" - 8"
7. End Connection	ISO 27509, IX
8. Pressure Class	2500
9. Temperature	-50°C to 200°C
10. Material Class	Duplex Steel
11. Body Material	ASTM A182 Gr F55
12. Obturator Material	Super Duplex (UNS S32760)
13. Seat Material	Super Duplex (UNS S32760)
14. Seat Insert	N/A
15. Spring (Seat) Material	UNS N07750
16. Stem Material	ASTM A276 (UNS S32760)
17. Seat-Stem Seal	Group E (acc. item A.7.1.5.6)
18. Operator Type	Gearbox
19. Additional Requirement	Fire Tested (acc. item A.6.1.4); Fugitive Emission (acc. item A.6.1.6)
20. Seat Type	(For trunnion-mounted) Side A: SPE / Side B: DPE; DIB-2 & DBB
21. Bore Type	Full Bore
22. Body Construction	Compact flangeless single body double ball valve. Face to face according ASME B16.10
23. Cladding or Coating	N/A
24. Valve Testing	FAT according A.9.3
25. Notes	All materials described in this datasheet are required for both valve, Needle valve between balls for cavity-pressure relief

Valve Code	VDE-300-2-C101
Specs	C10
1. Valve Type	Double Ball
2. Sealing Type	Soft
3. Valve Specification Level (VSL)	VSL-2
4. Obturator Type	Floating
5. Standard	ASME B16.34
6. Size Range (NPS)	1/2" - 2"
7. End Connection	Flanged ASME B16.5, RF
8. Pressure Class	300
9. Temperature	-29°C to 150°C
10. Material Class	Carbon Steel
11. Body Material	ASTM A105
12. Obturator Material	AISI 410
13. Seat Material	PTFE reinforced with 25% Carbon
14. Seat Insert Material	N/A
15. Spring Material	N/A
16. Stem Material	ASTM A276 (UNS S31600)
17. Stem Seal Material	Group B (acc. item A.7.1.5.6)
18. Operator Type	Lever
19. Additional Requirement	Fire Tested (acc. item A.6.1.4)
20. Seat Type	N/A
21. Bore Type	Full Bore
22. Body Construction	One piece forged body
23. Product Testing	FAT according A.9.3
24. Cladding or Coating	N/A
25. Notes	Needle valve between balls for cavity-pressure relief Max weight 55kg Minimum bore size 10mm

Valve Code	VDE-300-2-C102
Specs	C10
1. Valve Type	Double Ball
2. Sealing Type	Soft
3. Valve Specification Level (VSL)	VSL-2
4. Obturator Type	Floating
5. Standard	ASME B16.34
6. Size Range (NPS)	1/2" - 2"
7. End Connection	Flanged ASME B16.5, RF x NPT 1/2" ASME B1.20.1
8. Pressure Class	300
9. Temperature	-29°C to 150°C
10. Material Class	Carbon Steel
11. Body Material	ASTM A105
12. Obturator Material	AISI 410
13. Seat Material	PTFE reinforced with 25% Carbon
14. Seat Insert Material	N/A
15. Spring Material	N/A
16. Stem Material	ASTM A276 (UNS S31600)
17. Stem Seal Material	Group B (acc. item A.7.1.5.6)
18. Operator Type	Lever
19. Additional Requirement	Fire Tested (acc. item A.6.1.4)
20. Seat Type	N/A
21. Bore Type	Full Bore
22. Body Construction	One piece forged body
23. Product Testing	FAT according A.9.3
24. Cladding or Coating	N/A
25. Notes	Needle valve between balls for cavity-pressure relief Max weight 55kg Minimum bore size 10mm

Valve Code	VDE-300-2-C105
Specs	C10
1. Valve Type	Double Ball
2. Sealing Type	Metal to Metal
3. Valve Specification Level (VSL)	VSL-2
4. Obturator Type	Floating
5. Standard	ASME B16.34
6. Size Range (NPS)	1/2" - 2"
7. End Connection	Flanged ASME B16.5, RF
8. Pressure Class	300
9. Temperature	-29°C to 200°C
10. Material Class	Carbon Steel
11. Body Material	ASTM A105
12. Obturator Material	AISI 410
13. Seat Material	AISI 316
14. Seat Insert Material	N/A
15. Spring Material	N/A
16. Stem Material	ASTM A276 (UNS S31600)
17. Stem Seal Material	Group E (acc. item A.7.1.5.6)
18. Operator Type	Lever
19. Additional Requirement	Fire Tested (acc. item A.6.1.4)
20. Seat Type	N/A
21. Bore Type	Full Bore
22. Body Construction	One piece forged body
23. Product Testing	FAT according A.9.3
24. Cladding or Coating	N/A
25. Notes	Needle valve between balls for cavity-pressure relief Max weight 55kg Minimum bore size 10mm

Valve Code	VDE-300-2-C106
Specs	C10
1. Valve Type	Double Ball
2. Sealing Type	Metal to Metal
3. Valve Specification Level (VSL)	VSL-2
4. Obturator Type	Floating
5. Standard	ASME B16.34
6. Size Range (NPS)	1/2" - 2"
7. End Connection	Flanged ASME B16.5, RF x NPT 1/2" ASME B1.20.1
8. Pressure Class	300
9. Temperature	-29°C to 200°C
10. Material Class	Carbon Steel
11. Body Material	ASTM A105
12. Obturator Material	AISI 410
13. Seat Material	AISI 316
14. Seat Insert Material	N/A
15. Spring Material	N/A
16. Stem Material	ASTM A276 (UNS S31600)
17. Stem Seal Material	Group E (acc. item A.7.1.5.6)
18. Operator Type	Lever
19. Additional Requirement	Fire Tested (acc. item A.6.1.4)
20. Seat Type	N/A
21. Bore Type	Full Bore
22. Body Construction	One piece forged body
23. Product Testing	FAT according A.9.3
24. Cladding or Coating	N/A
25. Notes	Needle valve between balls for cavity-pressure relief Max weight 55kg Minimum bore size 10mm

Valve Code	VDE-300-2-C114
Specs	C10
1. Valve Type	Double Ball
2. Sealing Type	Soft
3. Valve Specification Level (VSL)	VSL-2
4. Ball Mouting	Trunnion
5. Standard	API 6D
6. Size Range (NPS)	3" - 8"
7. End Connection	RF
8. Pressure Class	300
9. Temperature	-29°C to 150°C
10. Material Class	Carbon Steel
11. Body Material	ASTM A105 or ASTM A216 Gr WCB + SS316 weld overlay (acc. item A.7.1.7.3)
12. Obturator Material	AISI 410
13. Seat Material	AISI 410
14. Seat Insert	PEEK
15. Spring (Seat) Material	UNS N07750
16. Stem Material	ASTM A276 (UNS S41000)
17. Seat-Stem Seal	Group B (acc. item A.7.1.5.6)
18. Operator Type	3" Lever 4" - 8" Gearbox
19. Additional Requirement	N/A
20. Seat Type	(For trunnion-mounted) Side A: SPE / Side B: SPE; DBB
21. Bore Type	Full Bore
22. Body Construction	Compact flangeless single body double ball valve. Face to face according ASME B16.10
23. Cladding or Coating	Partial clad - SS316 weld overlay on all body sealing areas
24. Valve Testing	FAT according A.9.3
25. Notes	All materials described in this datasheet are required for both valve, Needle valve between balls for cavity-pressure relief

Valve Code	VDE-300-2-C115
Specs	C10
1. Valve Type	Double Ball
2. Sealing Type	Soft
3. Valve Specification Level (VSL)	VSL-2
4. Ball Mouting	Trunnion
5. Standard	API 6D
6. Size Range (NPS)	3" - 8"
7. End Connection	RF
8. Pressure Class	300
9. Temperature	-29°C to 150°C
10. Material Class	Carbon Steel
11. Body Material	ASTM A105 or ASTM A216 Gr WCB + SS316 weld overlay (acc. item A.7.1.7.3)
12. Obturator Material	AISI 410
13. Seat Material	AISI 410
14. Seat Insert	PEEK
15. Spring (Seat) Material	UNS N07750
16. Stem Material	ASTM A276 (UNS S41000)
17. Seat-Stem Seal	Group B (acc. item A.7.1.5.6)
18. Operator Type	3" Lever 4" - 8" Gearbox
19. Additional Requirement	Fire Tested (acc. item A.6.1.4)
20. Seat Type	(For trunnion-mounted) Side A: SPE / Side B: SPE; DBB
21. Bore Type	Full Bore
22. Body Construction	Compact flangeless single body double ball valve. Face to face according ASME B16.10
23. Cladding or Coating	Partial clad - SS316 weld overlay on all body sealing areas
24. Valve Testing	FAT according A.9.3
25. Notes	All materials described in this datasheet are required for both valve, Needle valve between balls for cavity-pressure relief

Valve Code	VDE-300-2-C11F
Specs	C10
1. Valve Type	Double Ball
2. Sealing Type	Soft
3. Valve Specification Level (VSL)	VSL-2
4. Ball Mouting	Trunnion
5. Standard	API 6D
6. Size Range (NPS)	3" - 8"
7. End Connection	RF
8. Pressure Class	300
9. Temperature	-29°C to 150°C
10. Material Class	Carbon Steel
11. Body Material	ASTM A105 or ASTM A216 Gr WCB + SS316 weld overlay (acc. item A.7.1.7.3)
12. Obturator Material	AISI 410
13. Seat Material	AISI 410
14. Seat Insert	PTFE reinforced with 25% Carbon
15. Spring (Seat) Material	UNS N07750
16. Stem Material	ASTM A276 (UNS S41000)
17. Seat-Stem Seal	Group B (acc. item A.7.1.5.6)
18. Operator Type	3" Lever 4" - 8" Gearbox
19. Additional Requirement	Fire Tested (acc. item A.6.1.4); Fugitive Emission (acc. item A.6.1.6)
20. Seat Type	(For trunnion-mounted) Side A: SPE / Side B: SPE
21. Bore Type	Full Bore
22. Body Construction	Compact flangeless single body double ball valve. Face to face according ASME B16.10
23. Cladding or Coating	Partial clad - SS316 weld overlay on all body sealing areas
24. Valve Testing	FAT according A.9.3
25. Notes	All materials described in this datasheet are required for both valve, Needle valve between balls for cavity-pressure relief

Valve Code	VDE-300-2-C1F1
Specs	C10
1. Valve Type	Double Ball
2. Sealing Type	Soft
3. Valve Specification Level (VSL)	VSL-2
4. Obturator Type	Floating
5. Standard	ASME B16.34
6. Size Range (NPS)	1/2" - 2"
7. End Connection	Flanged ASME B16.5, RF
8. Pressure Class	300
9. Temperature	-29°C to 150°C
10. Material Class	Carbon Steel
11. Body Material	ASTM A105
12. Obturator Material	AISI 410
13. Seat Material	PTFE reinforced with 25% Carbon
14. Seat Insert Material	N/A
15. Spring Material	N/A
16. Stem Material	ASTM A276 (UNS S31600)
17. Stem Seal Material	Group B (acc. item A.7.1.5.6)
18. Operator Type	Lever
19. Additional Requirement	Fire Tested (acc. item A.6.1.4); Fugitive Emission (acc. item A.6.1.6)
20. Seat Type	N/A
21. Bore Type	Full Bore
22. Body Construction	One piece forged body
23. Product Testing	FAT according A.9.3
24. Cladding or Coating	N/A
25. Notes	Needle valve between balls for cavity-pressure relief Max weight 55kg Minimum bore size 10mm



Valve Code	VDE-300-2-C1F2
Specs	C10
1. Valve Type	Double Ball
2. Sealing Type	Soft
3. Valve Specification Level (VSL)	VSL-2
4. Obturator Type	Floating
5. Standard	ASME B16.34
6. Size Range (NPS)	½" - 2"
7. End Connection	Flanged ASME B16.5, RF x NPT 1/2" ASME B1.20.1
8. Pressure Class	300
9. Temperature	-29°C to 150°C
10. Material Class	Carbon Steel
11. Body Material	ASTM A105
12. Obturator Material	AISI 410
13. Seat Material	PTFE reinforced with 25% Carbon
14. Seat Insert Material	N/A
15. Spring Material	N/A
16. Stem Material	ASTM A276 (UNS S31600)
17. Stem Seal Material	Group B (acc. item A.7.1.5.6)
18. Operator Type	Lever
19. Additional Requirement	Fire Tested (acc. item A.6.1.4); Fugitive Emission (acc. item A.6.1.6)
20. Seat Type	N/A
21. Bore Type	Full Bore
22. Body Construction	One piece forged body
23. Product Testing	FAT according A.9.3
24. Cladding or Coating	N/A
25. Notes	Needle valve between balls for cavity-pressure relief Max weight 55kg Minimum bore size 10mm

Valve Code	VDE-300-2-C1F5
Specs	C10
1. Valve Type	Double Ball
2. Sealing Type	Metal to Metal
3. Valve Specification Level (VSL)	VSL-2
4. Obturator Type	Floating
5. Standard	ASME B16.34
6. Size Range (NPS)	½" - 2"
7. End Connection	Flanged ASME B16.5, RF
8. Pressure Class	300
9. Temperature	-29°C to 200°C
10. Material Class	Carbon Steel
11. Body Material	ASTM A105
12. Obturator Material	AISI 410
13. Seat Material	AISI 316
14. Seat Insert Material	N/A
15. Spring Material	N/A
16. Stem Material	ASTM A276 (UNS S31600)
17. Stem Seal Material	Group E (acc. item A.7.1.5.6)
18. Operator Type	Lever
19. Additional Requirement	Fire Tested (acc. item A.6.1.4); Fugitive Emission (acc. item A.6.1.6)
20. Seat Type	N/A
21. Bore Type	Full Bore
22. Body Construction	One piece forged body
23. Product Testing	FAT according A.9.3
24. Cladding or Coating	N/A
25. Notes	Needle valve between balls for cavity-pressure relief Max weight 55kg Minimum bore size 10mm

Valve Code	VDE-300-2-C1F6
Specs	C10
1. Valve Type	Double Ball
2. Sealing Type	Metal to Metal
3. Valve Specification Level (VSL)	VSL-2
4. Obturator Type	Floating
5. Standard	ASME B16.34
6. Size Range (NPS)	½" - 2"
7. End Connection	Flanged ASME B16.5, RF x NPT 1/2" ASME B1.20.1
8. Pressure Class	300
9. Temperature	-29°C to 200°C
10. Material Class	Carbon Steel
11. Body Material	ASTM A105
12. Obturator Material	AISI 410
13. Seat Material	AISI 316
14. Seat Insert Material	N/A
15. Spring Material	N/A
16. Stem Material	ASTM A276 (UNS S31600)
17. Stem Seal Material	Group E (acc. item A.7.1.5.6)
18. Operator Type	Lever
19. Additional Requirement	Fire Tested (acc. item A.6.1.4); Fugitive Emission (acc. item A.6.1.6)
20. Seat Type	N/A
21. Bore Type	Full Bore
22. Body Construction	One piece forged body
23. Product Testing	FAT according A.9.3
24. Cladding or Coating	N/A
25. Notes	Needle valve between balls for cavity-pressure relief Max weight 55kg Minimum bore size 10mm

Valve Code	VDE-300-2-C1F7
Specs	C10
1. Valve Type	Double Ball
2. Sealing Type	Metal to Metal
3. Valve Specification Level (VSL)	VSL-2
4. Obturator Type	Floating
5. Standard	ASME B16.34
6. Size Range (NPS)	½" - 2"
7. End Connection	Flanged ASME B16.5, RF
8. Pressure Class	300
9. Temperature	-29°C to 340°C
10. Material Class	Carbon Steel
11. Body Material	ASTM A105
12. Obturator Material	AISI 410
13. Seat Material	AISI 316
14. Seat Insert Material	N/A
15. Spring Material	N/A
16. Stem Material	ASTM A276 (UNS S31600)
17. Stem Seal Material	Group F (acc. item A.7.1.5.6)
18. Operator Type	Lever
19. Additional Requirement	Fire Tested (acc. item A.6.1.4); Fugitive Emission (acc. item A.6.1.6)
20. Seat Type	N/A
21. Bore Type	Full Bore
22. Body Construction	One piece forged body
23. Product Testing	FAT according A.9.3
24. Cladding or Coating	N/A
25. Notes	Needle valve between balls for cavity-pressure relief Max weight 55kg Minimum bore size 10mm

Valve Code	VDE-300-2-C1F8
Specs	C10
1. Valve Type	Double Ball
2. Sealing Type	Metal to Metal
3. Valve Specification Level (VSL)	VSL-2
4. Obturator Type	Floating
5. Standard	ASME B16.34
6. Size Range (NPS)	½" - 2"
7. End Connection	Flanged ASME B16.5, RF x NPT 1/2" ASME B1.20.1
8. Pressure Class	300
9. Temperature	-29°C to 340°C
10. Material Class	Carbon Steel
11. Body Material	ASTM A105
12. Obturator Material	AISI 410
13. Seat Material	AISI 316
14. Seat Insert Material	N/A
15. Spring Material	N/A
16. Stem Material	ASTM A276 (UNS S31600)
17. Stem Seal Material	Group F (acc. item A.7.1.5.6)
18. Operator Type	Lever
19. Additional Requirement	Fire Tested (acc. item A.6.1.4); Fugitive Emission (acc. item A.6.1.6)
20. Seat Type	N/A
21. Bore Type	Full Bore
22. Body Construction	One piece forged body
23. Product Testing	FAT according A.9.3
24. Cladding or Coating	N/A
25. Notes	Needle valve between balls for cavity-pressure relief Max weight 55kg Minimum bore size 10mm

Valve Code	VDE-300-2-C201
Specs	C6
1. Valve Type	Double Ball
2. Sealing Type	Soft
3. Valve Specification Level (VSL)	VSL-2
4. Obturator Type	Floating
5. Standard	ASME B16.34
6. Size Range (NPS)	½" - 2"
7. End Connection	Flanged ASME B16.5, RF
8. Pressure Class	300
9. Temperature	-30°C to 150°C
10. Material Class	Low-Temperature Carbon Steel
11. Body Material	ASTM A350 Gr LF2 CL1
12. Obturator Material	AISI 316
13. Seat Material	PTFE reinforced with 25% Carbon
14. Seat Insert Material	N/A
15. Spring Material	N/A
16. Stem Material	ASTM A276 (UNS S31600)
17. Stem Seal Material	Group B (acc. item A.7.1.5.6)
18. Operator Type	Lever
19. Additional Requirement	Fire Tested (acc. item A.6.1.4)
20. Seat Type	N/A
21. Bore Type	Full Bore
22. Body Construction	One piece forged body
23. Product Testing	FAT according A.9.3
24. Cladding or Coating	N/A
25. Notes	Needle valve between balls for cavity-pressure relief Max weight 55kg Minimum bore size 10mm

Valve Code	VDE-300-2-C202
Specs	C6
1. Valve Type	Double Ball
2. Sealing Type	Soft
3. Valve Specification Level (VSL)	VSL-2
4. Obturator Type	Floating
5. Standard	ASME B16.34
6. Size Range (NPS)	½" - 2"
7. End Connection	Flanged ASME B16.5, RF x NPT 1/2" ASME B1.20.1
8. Pressure Class	300
9. Temperature	-30°C to 150°C
10. Material Class	Low-Temperature Carbon Steel
11. Body Material	ASTM A350 Gr LF2 CL1
12. Obturator Material	AISI 316
13. Seat Material	PTFE reinforced with 25% Carbon
14. Seat Insert Material	N/A
15. Spring Material	N/A
16. Stem Material	ASTM A276 (UNS S31600)
17. Stem Seal Material	Group B (acc. item A.7.1.5.6)
18. Operator Type	Lever
19. Additional Requirement	Fire Tested (acc. item A.6.1.4)
20. Seat Type	N/A
21. Bore Type	Full Bore
22. Body Construction	One piece forged body
23. Product Testing	FAT according A.9.3
24. Cladding or Coating	N/A
25. Notes	Needle valve between balls for cavity-pressure relief Max weight 55kg Minimum bore size 10mm

Valve Code	VDE-300-2-C205
Specs	C6
1. Valve Type	Double Ball
2. Sealing Type	Metal to Metal
3. Valve Specification Level (VSL)	VSL-2
4. Obturator Type	Floating
5. Standard	ASME B16.34
6. Size Range (NPS)	½" - 2"
7. End Connection	Flanged ASME B16.5, RF
8. Pressure Class	300
9. Temperature	-46°C to 200°C
10. Material Class	Low-Temperature Carbon Steel
11. Body Material	ASTM A350 Gr LF2 CL1
12. Obturator Material	AISI 316 + Hard Coating (acc. item A.7.1.7.4)
13. Seat Material	AISI 316 + Hard Coating (acc. item A.7.1.7.4)
14. Seat Insert Material	N/A
15. Spring Material	N/A
16. Stem Material	ASTM A276 (UNS S31600)
17. Stem Seal Material	Group E (acc. item A.7.1.5.6)
18. Operator Type	Lever
19. Additional Requirement	Fire Tested (acc. item A.6.1.4)
20. Seat Type	N/A
21. Bore Type	Full Bore
22. Body Construction	One piece forged body
23. Product Testing	FAT according A.9.3
24. Cladding or Coating	N/A
25. Notes	Needle valve between balls for cavity-pressure relief Max weight 55kg Minimum bore size 10mm

Valve Code	VDE-300-2-C206
Specs	C6
1. Valve Type	Double Ball
2. Sealing Type	Metal to Metal
3. Valve Specification Level (VSL)	VSL-2
4. Obturator Type	Floating
5. Standard	ASME B16.34
6. Size Range (NPS)	½" - 2"
7. End Connection	Flanged ASME B16.5, RF x NPT 1/2" ASME B1.20.1
8. Pressure Class	300
9. Temperature	-46°C to 200°C
10. Material Class	Low-Temperature Carbon Steel
11. Body Material	ASTM A350 Gr LF2 CL1
12. Obturator Material	AISI 316 + Hard Coating (acc. item A.7.1.7.4)
13. Seat Material	AISI 316 + Hard Coating (acc. item A.7.1.7.4)
14. Seat Insert Material	N/A
15. Spring Material	N/A
16. Stem Material	ASTM A276 (UNS S31600)
17. Stem Seal Material	Group E (acc. item A.7.1.5.6)
18. Operator Type	Lever
19. Additional Requirement	Fire Tested (acc. item A.6.1.4)
20. Seat Type	N/A
21. Bore Type	Full Bore
22. Body Construction	One piece forged body
23. Product Testing	FAT according A.9.3
24. Cladding or Coating	N/A
25. Notes	Needle valve between balls for cavity-pressure relief Max weight 55kg Minimum bore size 10mm

Valve Code	VDE-300-2-C215
Specs	C6
1. Valve Type	Double Ball
2. Sealing Type	Soft
3. Valve Specification Level (VSL)	VSL-2
4. Ball Mounting	Trunnion
5. Standard	API 6D
6. Size Range (NPS)	3" - 8"
7. End Connection	RF
8. Pressure Class	300
9. Temperature	-30°C to 150°C
10. Material Class	Low-Temperature Carbon Steel
11. Body Material	ASTM A350 Gr LF2 CL1 or ASTM A352 Gr LCC + SS316 weld overlay (acc. item A.7.1.7.3)
12. Obturator Material	AISI 316
13. Seat Material	AISI 410
14. Seat Insert	PEEK
15. Spring (Seat) Material	UNS N07750
16. Stem Material	ASTM A276 (UNS S31600)
17. Seat-Stem Seal	Group B (acc. item A.7.1.5.6)
18. Operator Type	3" Lever 4" - 8" Gearbox
19. Additional Requirement	Fire Tested (acc. item A.6.1.4)
20. Seat Type	(For trunnion-mounted) Side A: SPE / Side B: SPE; DBB
21. Bore Type	Full Bore
22. Body Construction	Compact flangeless single body double ball valve. Face to face according ASME B16.10
23. Cladding or Coating	Partial clad - SS316 weld overlay on all body sealing areas
24. Valve Testing	FAT according A.9.3
25. Notes	All materials described in this datasheet are required for both valve. Needle valve between balls for cavity-pressure relief

Valve Code	VDE-300-2-C21F
Specs	C6
1. Valve Type	Double Ball
2. Sealing Type	Soft
3. Valve Specification Level (VSL)	VSL-2
4. Ball Mounting	Trunnion
5. Standard	API 6D
6. Size Range (NPS)	3" - 8"
7. End Connection	RF
8. Pressure Class	300
9. Temperature	-30°C to 150°C
10. Material Class	Low-Temperature Carbon Steel
11. Body Material	ASTM A350 Gr LF2 CL1 or ASTM A352 Gr LCC + SS316 weld overlay (acc. item A.7.1.7.3)
12. Obturator Material	AISI 316
13. Seat Material	AISI 410
14. Seat Insert	PTFE reinforced with 25% Carbon
15. Spring (Seat) Material	UNS N07750
16. Stem Material	ASTM A276 (UNS S31600)
17. Seat-Stem Seal	Group B (acc. item A.7.1.5.6)
18. Operator Type	3" Lever 4" - 8" Gearbox
19. Additional Requirement	Fire Tested (acc. item A.6.1.4); Fugitive Emission (acc. item A.6.1.6)
20. Seat Type	(For trunnion-mounted) Side A: SPE / Side B: SPE
21. Bore Type	Full Bore
22. Body Construction	Compact flangeless single body double ball valve. Face to face according ASME B16.10
23. Cladding or Coating	Partial clad - SS316 weld overlay on all body sealing areas
24. Valve Testing	FAT according A.9.3
25. Notes	All materials described in this datasheet are required for both valve. Needle valve between balls for cavity-pressure relief

Valve Code	VDE-300-2-C27F
Specs	C6
1. Valve Type	Double Ball
2. Sealing Type	Metal to Metal
3. Valve Specification Level (VSL)	VSL-2
4. Ball Mounting	Trunnion
5. Standard	API 6D
6. Size Range (NPS)	3" - 8"
7. End Connection	RF
8. Pressure Class	300
9. Temperature	-46°C to 200°C
10. Material Class	Low-Temperature Carbon Steel
11. Body Material	ASTM A350 Gr LF2 CL1 or ASTM A352 Gr LCC + SS316 weld overlay (acc. item A.7.1.7.3)
12. Obturator Material	AISI 316
13. Seat Material	AISI 410
14. Seat Insert	N/A
15. Spring (Seat) Material	UNS N07750
16. Stem Material	ASTM A276 (UNS S31600)
17. Seat-Stem Seal	Group E (acc. item A.7.1.5.6)
18. Operator Type	3" Lever 4" - 8" Gearbox
19. Additional Requirement	Fire Tested (acc. item A.6.1.4); Fugitive Emission (acc. item A.6.1.6)
20. Seat Type	(For trunnion-mounted) Side A: SPE / Side B: SPE
21. Bore Type	Full Bore
22. Body Construction	Compact flangeless single body double ball valve. Face to face according ASME B16.10
23. Cladding or Coating	Partial clad - SS316 weld overlay on all body sealing areas
24. Valve Testing	FAT according A.9.3
25. Notes	All materials described in this datasheet are required for both valve. Needle valve between balls for cavity-pressure relief

Valve Code	VDE-300-2-C2F1
Specs	C6
1. Valve Type	Double Ball
2. Sealing Type	Soft
3. Valve Specification Level (VSL)	VSL-2
4. Obturator Type	Floating
5. Standard	ASME B16.34
6. Size Range (NPS)	½" - 2"
7. End Connection	Flanged ASME B16.5, RF
8. Pressure Class	300
9. Temperature	-30°C to 150°C
10. Material Class	Low-Temperature Carbon Steel
11. Body Material	ASTM A350 Gr LF2 CL1
12. Obturator Material	AISI 316
13. Seat Material	PTFE reinforced with 25% Carbon
14. Seat Insert Material	N/A
15. Spring Material	N/A
16. Stem Material	ASTM A276 (UNS S31600)
17. Stem Seal Material	Group B (acc. item A.7.1.5.6)
18. Operator Type	Lever
19. Additional Requirement	Fire Tested (acc. item A.6.1.4); Fugitive Emission (acc. item A.6.1.6)
20. Seat Type	N/A
21. Bore Type	Full Bore
22. Body Construction	One piece forged body
23. Product Testing	FAT according A.9.3
24. Cladding or Coating	N/A
25. Notes	Needle valve between balls for cavity-pressure relief Max weight 55kg Minimum bore size 10mm

Valve Code	VDE-300-2-C2F2
Specs	C6
1. Valve Type	Double Ball
2. Sealing Type	Soft
3. Valve Specification Level (VSL)	VSL-2
4. Obturator Type	Floating
5. Standard	ASME B16.34
6. Size Range (NPS)	½" - 2"
7. End Connection	Flanged ASME B16.5, RF x NPT 1/2" ASME B1.20.1
8. Pressure Class	300
9. Temperature	-30°C to 150°C
10. Material Class	Low-Temperature Carbon Steel
11. Body Material	ASTM A350 Gr LF2 CL1
12. Obturator Material	AISI 316
13. Seat Material	PTFE reinforced with 25% Carbon
14. Seat Insert Material	N/A
15. Spring Material	N/A
16. Stem Material	ASTM A276 (UNS S31600)
17. Stem Seal Material	Group B (acc. item A.7.1.5.6)
18. Operator Type	Lever
19. Additional Requirement	Fire Tested (acc. item A.6.1.4); Fugitive Emission (acc. item A.6.1.6)
20. Seat Type	N/A
21. Bore Type	Full Bore
22. Body Construction	One piece forged body
23. Product Testing	FAT according A.9.3
24. Cladding or Coating	N/A
25. Notes	Needle valve between balls for cavity-pressure relief Max weight 55kg Minimum bore size 10mm

Valve Code	VDE-300-2-C2F5
Specs	C6
1. Valve Type	Double Ball
2. Sealing Type	Metal to Metal
3. Valve Specification Level (VSL)	VSL-2
4. Obturator Type	Floating
5. Standard	ASME B16.34
6. Size Range (NPS)	½" - 2"
7. End Connection	Flanged ASME B16.5, RF
8. Pressure Class	300
9. Temperature	-46°C to 200°C
10. Material Class	Low-Temperature Carbon Steel
11. Body Material	ASTM A350 Gr LF2 CL1
12. Obturator Material	AISI 316 + Hard Coating (acc. item A.7.1.7.4)
13. Seat Material	AISI 316 + Hard Coating (acc. item A.7.1.7.4)
14. Seat Insert Material	N/A
15. Spring Material	N/A
16. Stem Material	ASTM A276 (UNS S31600)
17. Stem Seal Material	Group E (acc. item A.7.1.5.6)
18. Operator Type	Lever
19. Additional Requirement	Fire Tested (acc. item A.6.1.4); Fugitive Emission (acc. item A.6.1.6)
20. Seat Type	N/A
21. Bore Type	Full Bore
22. Body Construction	One piece forged body
23. Product Testing	FAT according A.9.3
24. Cladding or Coating	N/A
25. Notes	Needle valve between balls for cavity-pressure relief Max weight 55kg Minimum bore size 10mm

Valve Code	VDE-300-2-C2F6
Specs	C6
1. Valve Type	Double Ball
2. Sealing Type	Metal to Metal
3. Valve Specification Level (VSL)	VSL-2
4. Obturator Type	Floating
5. Standard	ASME B16.34
6. Size Range (NPS)	½" - 2"
7. End Connection	Flanged ASME B16.5, RF x NPT 1/2" ASME B1.20.1
8. Pressure Class	300
9. Temperature	-46°C to 200°C
10. Material Class	Low-Temperature Carbon Steel
11. Body Material	ASTM A350 Gr LF2 CL1
12. Obturator Material	AISI 316 + Hard Coating (acc. item A.7.1.7.4)
13. Seat Material	AISI 316 + Hard Coating (acc. item A.7.1.7.4)
14. Seat Insert Material	N/A
15. Spring Material	N/A
16. Stem Material	ASTM A276 (UNS S31600)
17. Stem Seal Material	Group E (acc. item A.7.1.5.6)
18. Operator Type	Lever
19. Additional Requirement	Fire Tested (acc. item A.6.1.4); Fugitive Emission (acc. item A.6.1.6)
20. Seat Type	N/A
21. Bore Type	Full Bore
22. Body Construction	One piece forged body
23. Product Testing	FAT according A.9.3
24. Cladding or Coating	N/A
25. Notes	Needle valve between balls for cavity-pressure relief Max weight 55kg Minimum bore size 10mm

Valve Code	VDE-300-2-C510
Specs	C30
1. Valve Type	Double Ball
2. Sealing Type	Soft
3. Valve Specification Level (VSL)	VSL-2
4. Ball Mouting	Trunnion
5. Standard	API 6D
6. Size Range (NPS)	3" - 8"
7. End Connection	RF
8. Pressure Class	300
9. Temperature	-29°C to 150°C
10. Material Class	Carbon Steel
11. Body Material	ASTM A105 or ASTM A216 Gr WCB + Inconel 625 weld overlay (acc. item A.7.1.7.3)
12. Obturator Material	ASTM A105 + Inconel 625 weld overlay (acc. item A.7.1.7.3)
13. Seat Material	ASTM A105 + Inconel 625 weld overlay (acc. item A.7.1.7.3)
14. Seat Insert	PTFE reinforced with 25% Carbon
15. Spring (Seat) Material	UNS N07750
16. Stem Material	ASTM B637 (UNS N07718)
17. Seat-Stem Seal	Group B (acc. item A.7.1.5.6)
18. Operator Type	3" - 4" - 8" Lever Gearbox
19. Additional Requirement	N/A
20. Seat Type	(For trunnion-mounted) Side A: SPE / Side B: SPE
21. Bore Type	Full Bore
22. Body Construction	Compact flangeless single body double ball valve. Face to face according ASME B16.10
23. Cladding or Coating	Full clad - Inconel 625 weld overlay on all wetted parts
24. Valve Testing	FAT according A.9.3
25. Notes	All materials described in this datasheet are required for both valve, Needle valve between balls for cavity-pressure relief

Valve Code	VDE-300-2-C51F
Specs	C30
1. Valve Type	Double Ball
2. Sealing Type	Soft
3. Valve Specification Level (VSL)	VSL-2
4. Ball Mouting	Trunnion
5. Standard	API 6D
6. Size Range (NPS)	3" - 8"
7. End Connection	RF
8. Pressure Class	300
9. Temperature	-29°C to 150°C
10. Material Class	Carbon Steel
11. Body Material	ASTM A105 or ASTM A216 Gr WCB + Inconel 625 weld overlay (acc. item A.7.1.7.3)
12. Obturator Material	ASTM A105 + Inconel 625 weld overlay (acc. item A.7.1.7.3)
13. Seat Material	ASTM A105 + Inconel 625 weld overlay (acc. item A.7.1.7.3)
14. Seat Insert	PTFE reinforced with 25% Carbon
15. Spring (Seat) Material	UNS N07750
16. Stem Material	ASTM B637 (UNS N07718)
17. Seat-Stem Seal	Group B (acc. item A.7.1.5.6)
18. Operator Type	3" - 4" - 8" Lever Gearbox
19. Additional Requirement	Fire Tested (acc. item A.6.1.4); Fugitive Emission (acc. item A.6.1.6)
20. Seat Type	(For trunnion-mounted) Side A: SPE / Side B: SPE
21. Bore Type	Full Bore
22. Body Construction	Compact flangeless single body double ball valve. Face to face according ASME B16.10
23. Cladding or Coating	Full clad - Inconel 625 weld overlay on all wetted parts
24. Valve Testing	FAT according A.9.3
25. Notes	All materials described in this datasheet are required for both valve, Needle valve between balls for cavity-pressure relief

Valve Code	VDE-300-2-C57F
Specs	C30
1. Valve Type	Double Ball
2. Sealing Type	Metal to Metal
3. Valve Specification Level (VSL)	VSL-2
4. Ball Mouting	Trunnion
5. Standard	API 6D
6. Size Range (NPS)	3" - 8"
7. End Connection	RF
8. Pressure Class	300
9. Temperature	-29°C to 200°C
10. Material Class	Carbon Steel
11. Body Material	ASTM A105 or ASTM A216 Gr WCB + Inconel 625 weld overlay (acc. item A.7.1.7.3)
12. Obturator Material	ASTM A105 + Inconel 625 weld overlay (acc. item A.7.1.7.3)
13. Seat Material	ASTM A105 + Inconel 625 weld overlay (acc. item A.7.1.7.3)
14. Seat Insert	N/A
15. Spring (Seat) Material	UNS N07750
16. Stem Material	ASTM B637 (UNS N07718)
17. Seat-Stem Seal	Group E (acc. item A.7.1.5.6)
18. Operator Type	3" - 4" - 8" Lever Gearbox
19. Additional Requirement	Fire Tested (acc. item A.6.1.4); Fugitive Emission (acc. item A.6.1.6)
20. Seat Type	(For trunnion-mounted) Side A: SPE / Side B: SPE
21. Bore Type	Full Bore
22. Body Construction	Compact flangeless single body double ball valve. Face to face according ASME B16.10
23. Cladding or Coating	Full clad - Inconel 625 weld overlay on all wetted parts
24. Valve Testing	FAT according A.9.3
25. Notes	All materials described in this datasheet are required for both valve, Needle valve between balls for cavity-pressure relief

Valve Code	VDE-300-2-D201
Specs	C16
1. Valve Type	Double Ball
2. Sealing Type	Soft
3. Valve Specification Level (VSL)	VSL-2
4. Obturator Type	Floating
5. Standard	ASME B16.34
6. Size Range (NPS)	½" - 2"
7. End Connection	Flanged ASME B16.5, RF
8. Pressure Class	300
9. Temperature	-30°C to 150°C
10. Material Class	Duplex Steel
11. Body Material	ASTM A182 Gr F51
12. Obturator Material	Duplex (UNS S31803)
13. Seat Material	PTFE reinforced with 25% Carbon
14. Seat Insert Material	N/A
15. Spring Material	N/A
16. Stem Material	ASTM A276 (UNS S31803)
17. Stem Seal Material	Group B (acc. item A.7.1.5.6)
18. Operator Type	Lever
19. Additional Requirement	Fire Tested (acc. item A.6.1.4)
20. Seat Type	N/A
21. Bore Type	Full Bore
22. Body Construction	One piece forged body
23. Product Testing	FAT according A.9.3
24. Cladding or Coating	N/A
25. Notes	Needle valve between balls for cavity-pressure relief Max weight 55kg Minimum bore size 10mm





Valve Code	VDE-300-2-D202
Specs	C16
1. Valve Type	Double Ball
2. Sealing Type	Soft
3. Valve Specification Level (VSL)	VSL-2
4. Obturator Type	Floating
5. Standard	ASME B16.34
6. Size Range (NPS)	½" - 2"
7. End Connection	Flanged ASME B16.5, RF x NPT 1/2" ASME B1.20.1
8. Pressure Class	300
9. Temperature	-30°C to 150°C
10. Material Class	Duplex Steel
11. Body Material	ASTM A182 Gr F51
12. Obturator Material	Duplex (UNS S31803)
13. Seat Material	PTFE reinforced with 25% Carbon
14. Seat Insert Material	N/A
15. Spring Material	N/A
16. Stem Material	ASTM A276 (UNS S31803)
17. Stem Seal Material	Group B (acc. item A.7.1.5.6)
18. Operator Type	Lever
19. Additional Requirement	Fire Tested (acc. item A.6.1.4)
20. Seat Type	N/A
21. Bore Type	Full Bore
22. Body Construction	One piece forged body
23. Product Testing	FAT according A.9.3
24. Cladding or Coating	N/A
25. Notes	Needle valve between balls for cavity-pressure relief Max weight 55kg Minimum bore size 10mm

Valve Code	VDE-300-2-D203
Specs	C16
1. Valve Type	Double Ball
2. Sealing Type	Soft
3. Valve Specification Level (VSL)	VSL-2
4. Obturator Type	Floating
5. Standard	ASME B16.34
6. Size Range (NPS)	½" - 2"
7. End Connection	Flanged ASME B16.5, RF
8. Pressure Class	300
9. Temperature	-46°C to 150°C
10. Material Class	Duplex Steel
11. Body Material	ASTM A182 Gr F51
12. Obturator Material	Duplex (UNS S31803)
13. Seat Material	PTFE reinforced with 25% Carbon
14. Seat Insert Material	N/A
15. Spring Material	N/A
16. Stem Material	ASTM A276 (UNS S31803)
17. Stem Seal Material	Group E (acc. item A.7.1.5.6)
18. Operator Type	Lever
19. Additional Requirement	Fire Tested (acc. item A.6.1.4)
20. Seat Type	N/A
21. Bore Type	Full Bore
22. Body Construction	One piece forged body
23. Product Testing	FAT according A.9.3
24. Cladding or Coating	N/A
25. Notes	Needle valve between balls for cavity-pressure relief Max weight 55kg Minimum bore size 10mm

Valve Code	VDE-300-2-D204
Specs	C16
1. Valve Type	Double Ball
2. Sealing Type	Soft
3. Valve Specification Level (VSL)	VSL-2
4. Obturator Type	Floating
5. Standard	ASME B16.34
6. Size Range (NPS)	½" - 2"
7. End Connection	Flanged ASME B16.5, RF x NPT 1/2" ASME B1.20.1
8. Pressure Class	300
9. Temperature	-46°C to 150°C
10. Material Class	Duplex Steel
11. Body Material	ASTM A182 Gr F51
12. Obturator Material	Duplex (UNS S31803)
13. Seat Material	PTFE reinforced with 25% Carbon
14. Seat Insert Material	N/A
15. Spring Material	N/A
16. Stem Material	ASTM A276 (UNS S31803)
17. Stem Seal Material	Group E (acc. item A.7.1.5.6)
18. Operator Type	Lever
19. Additional Requirement	Fire Tested (acc. item A.6.1.4)
20. Seat Type	N/A
21. Bore Type	Full Bore
22. Body Construction	One piece forged body
23. Product Testing	FAT according A.9.3
24. Cladding or Coating	N/A
25. Notes	Needle valve between balls for cavity-pressure relief Max weight 55kg Minimum bore size 10mm

Valve Code	VDE-300-2-D21F
Specs	C16
1. Valve Type	Double Ball
2. Sealing Type	Soft
3. Valve Specification Level (VSL)	VSL-2
4. Ball Mouting	Trunnion
5. Standard	API 6D
6. Size Range (NPS)	3" - 8"
7. End Connection	RF
8. Pressure Class	300
9. Temperature	-30°C to 150°C
10. Material Class	Duplex Steel
11. Body Material	ASTM A182 Gr F51 or ASTM A995 Gr 4A
12. Obturator Material	Duplex (UNS S31803)
13. Seat Material	Super Duplex (UNS S32760)
14. Seat Insert	PTFE reinforced with 25% Carbon
15. Spring (Seat) Material	UNS N07750
16. Stem Material	ASTM A276 (UNS S32760)
17. Seat-Stem Seal	Group B (acc. item A.7.1.5.6)
18. Operator Type	3" - 8" Lever Gearbox
19. Additional Requirement	Fire Tested (acc. item A.6.1.4); Fugitive Emission (acc. item A.6.1.6)
20. Seat Type	(For trunnion-mounted) Side A: SPE / Side B: SPE
21. Bore Type	Full Bore
22. Body Construction	Compact flangeless single body double ball valve. Face to face according ASME B16.10
23. Cladding or Coating	N/A
24. Valve Testing	FAT according A.9.3
25. Notes	All materials described in this datasheet are required for both valve, Needle valve between balls for cavity-pressure relief

Valve Code	VDE-300-2-D2F1
Specs	C16
1. Valve Type	Double Ball
2. Sealing Type	Soft
3. Valve Specification Level (VSL)	VSL-2
4. Obturator Type	Floating
5. Standard	ASME B16.34
6. Size Range (NPS)	½" - 2"
7. End Connection	Flanged ASME B16.5, RF
8. Pressure Class	300
9. Temperature	-30°C to 150°C
10. Material Class	Duplex Steel
11. Body Material	ASTM A182 Gr F51
12. Obturator Material	Duplex (UNS S31803)
13. Seat Material	PTFE reinforced with 25% Carbon
14. Seat Insert Material	N/A
15. Spring Material	N/A
16. Stem Material	ASTM A276 (UNS S31803)
17. Stem Seal Material	Group B (acc. item A.7.1.5.6)
18. Operator Type	Lever
19. Additional Requirement	Fire Tested (acc. item A.6.1.4); Fugitive Emission (acc. item A.6.1.6)
20. Seat Type	N/A
21. Bore Type	Full Bore
22. Body Construction	One piece forged body
23. Product Testing	FAT according A.9.3
24. Cladding or Coating	N/A
25. Notes	Needle valve between balls for cavity-pressure relief Max weight 55kg Minimum bore size 10mm

Valve Code	VDE-300-2-D2F2
Specs	C16
1. Valve Type	Double Ball
2. Sealing Type	Soft
3. Valve Specification Level (VSL)	VSL-2
4. Obturator Type	Floating
5. Standard	ASME B16.34
6. Size Range (NPS)	½" - 2"
7. End Connection	Flanged ASME B16.5, RF x NPT 1/2" ASME B1.20.1
8. Pressure Class	300
9. Temperature	-30°C to 150°C
10. Material Class	Duplex Steel
11. Body Material	ASTM A182 Gr F51
12. Obturator Material	Duplex (UNS S31803)
13. Seat Material	PTFE reinforced with 25% Carbon
14. Seat Insert Material	N/A
15. Spring Material	N/A
16. Stem Material	ASTM A276 (UNS S31803)
17. Stem Seal Material	Group B (acc. item A.7.1.5.6)
18. Operator Type	Lever
19. Additional Requirement	Fire Tested (acc. item A.6.1.4); Fugitive Emission (acc. item A.6.1.6)
20. Seat Type	N/A
21. Bore Type	Full Bore
22. Body Construction	One piece forged body
23. Product Testing	FAT according A.9.3
24. Cladding or Coating	N/A
25. Notes	Needle valve between balls for cavity-pressure relief Max weight 55kg Minimum bore size 10mm

Valve Code	VDE-300-2-D2F3
Specs	C16
1. Valve Type	Double Ball
2. Sealing Type	Soft
3. Valve Specification Level (VSL)	VSL-2
4. Obturator Type	Floating
5. Standard	ASME B16.34
6. Size Range (NPS)	½" - 2"
7. End Connection	Flanged ASME B16.5, RF
8. Pressure Class	300
9. Temperature	-46°C to 150°C
10. Material Class	Duplex Steel
11. Body Material	ASTM A182 Gr F51
12. Obturator Material	Duplex (UNS S31803)
13. Seat Material	PTFE reinforced with 25% Carbon
14. Seat Insert Material	N/A
15. Spring Material	N/A
16. Stem Material	ASTM A276 (UNS S31803)
17. Stem Seal Material	Group E (acc. item A.7.1.5.6)
18. Operator Type	Lever
19. Additional Requirement	Fire Tested (acc. item A.6.1.4); Fugitive Emission (acc. item A.6.1.6)
20. Seat Type	N/A
21. Bore Type	Full Bore
22. Body Construction	One piece forged body
23. Product Testing	FAT according A.9.3
24. Cladding or Coating	N/A
25. Notes	Needle valve between balls for cavity-pressure relief Max weight 55kg Minimum bore size 10mm

Valve Code	VDE-300-2-D2F4
Specs	C16
1. Valve Type	Double Ball
2. Sealing Type	Soft
3. Valve Specification Level (VSL)	VSL-2
4. Obturator Type	Floating
5. Standard	ASME B16.34
6. Size Range (NPS)	½" - 2"
7. End Connection	Flanged ASME B16.5, RF x NPT 1/2" ASME B1.20.1
8. Pressure Class	300
9. Temperature	-46°C to 150°C
10. Material Class	Duplex Steel
11. Body Material	ASTM A182 Gr F51
12. Obturator Material	Duplex (UNS S31803)
13. Seat Material	PTFE reinforced with 25% Carbon
14. Seat Insert Material	N/A
15. Spring Material	N/A
16. Stem Material	ASTM A276 (UNS S31803)
17. Stem Seal Material	Group E (acc. item A.7.1.5.6)
18. Operator Type	Lever
19. Additional Requirement	Fire Tested (acc. item A.6.1.4); Fugitive Emission (acc. item A.6.1.6)
20. Seat Type	N/A
21. Bore Type	Full Bore
22. Body Construction	One piece forged body
23. Product Testing	FAT according A.9.3
24. Cladding or Coating	N/A
25. Notes	Needle valve between balls for cavity-pressure relief Max weight 55kg Minimum bore size 10mm

Valve Code	VDE-300-2-N101
Specs	C30
1. Valve Type	Double Ball
2. Sealing Type	Soft
3. Valve Specification Level (VSL)	VSL-2
4. Obturator Type	Floating
5. Standard	ASME B16.34
6. Size Range (NPS)	½" - 2"
7. End Connection	Flanged ASME B16.5, RF
8. Pressure Class	300
9. Temperature	-30°C to 150°C
10. Material Class	Nickel Alloys
11. Body Material	ASTM B564 (UNS N06625)
12. Obturator Material	ASTM B564 (UNS N06625)
13. Seat Material	PTFE reinforced with 25% Carbon
14. Seat Insert Material	N/A
15. Spring Material	N/A
16. Stem Material	ASTM B637 (UNS N07718)
17. Stem Seal Material	Group B (acc. item A.7.1.5.6)
18. Operator Type	Lever
19. Additional Requirement	Fire Tested (acc. item A.6.1.4)
20. Seat Type	N/A
21. Bore Type	Full Bore
22. Body Construction	One piece forged body
23. Product Testing	FAT according A.9.3
24. Cladding or Coating	N/A
25. Notes	Needle valve between balls for cavity-pressure relief Max weight 55kg Minimum bore size 10mm

Valve Code	VDE-300-2-N102
Specs	C30
1. Valve Type	Double Ball
2. Sealing Type	Soft
3. Valve Specification Level (VSL)	VSL-2
4. Obturator Type	Floating
5. Standard	ASME B16.34
6. Size Range (NPS)	½" - 2"
7. End Connection	Flanged ASME B16.5, RF x NPT 1/2" ASME B1.20.1
8. Pressure Class	300
9. Temperature	-30°C to 150°C
10. Material Class	Nickel Alloys
11. Body Material	ASTM B564 (UNS N06625)
12. Obturator Material	ASTM B564 (UNS N06625)
13. Seat Material	PTFE reinforced with 25% Carbon
14. Seat Insert Material	N/A
15. Spring Material	N/A
16. Stem Material	ASTM B637 (UNS N07718)
17. Stem Seal Material	Group B (acc. item A.7.1.5.6)
18. Operator Type	Lever
19. Additional Requirement	Fire Tested (acc. item A.6.1.4)
20. Seat Type	N/A
21. Bore Type	Full Bore
22. Body Construction	One piece forged body
23. Product Testing	FAT according A.9.3
24. Cladding or Coating	N/A
25. Notes	Needle valve between balls for cavity-pressure relief Max weight 55kg Minimum bore size 10mm

Valve Code	VDE-300-2-N105
Specs	C30
1. Valve Type	Double Ball
2. Sealing Type	Metal to Metal
3. Valve Specification Level (VSL)	VSL-2
4. Obturator Type	Floating
5. Standard	ASME B16.34
6. Size Range (NPS)	½" - 2"
7. End Connection	Flanged ASME B16.5, RF
8. Pressure Class	300
9. Temperature	-100°C to 200°C
10. Material Class	Nickel Alloys
11. Body Material	ASTM B564 (UNS N06625)
12. Obturator Material	ASTM B564 (UNS N06625)
13. Seat Material	ASTM B564 (UNS N06625)
14. Seat Insert Material	N/A
15. Spring Material	N/A
16. Stem Material	ASTM B637 (UNS N07718)
17. Stem Seal Material	Group E (acc. item A.7.1.5.6)
18. Operator Type	Lever
19. Additional Requirement	Fire Tested (acc. item A.6.1.4)
20. Seat Type	N/A
21. Bore Type	Full Bore
22. Body Construction	One piece forged body
23. Product Testing	FAT according A.9.3
24. Cladding or Coating	N/A
25. Notes	Needle valve between balls for cavity-pressure relief Max weight 55kg Minimum bore size 10mm

Valve Code	VDE-300-2-N106
Specs	C30
1. Valve Type	Double Ball
2. Sealing Type	Metal to Metal
3. Valve Specification Level (VSL)	VSL-2
4. Obturator Type	Floating
5. Standard	ASME B16.34
6. Size Range (NPS)	½" - 2"
7. End Connection	Flanged ASME B16.5, RF x NPT 1/2" ASME B1.20.1
8. Pressure Class	300
9. Temperature	-100°C to 200°C
10. Material Class	Nickel Alloys
11. Body Material	ASTM B564 (UNS N06625)
12. Obturator Material	ASTM B564 (UNS N06625)
13. Seat Material	ASTM B564 (UNS N06625)
14. Seat Insert Material	N/A
15. Spring Material	N/A
16. Stem Material	ASTM B637 (UNS N07718)
17. Stem Seal Material	Group E (acc. item A.7.1.5.6)
18. Operator Type	Lever
19. Additional Requirement	Fire Tested (acc. item A.6.1.4)
20. Seat Type	N/A
21. Bore Type	Full Bore
22. Body Construction	One piece forged body
23. Product Testing	FAT according A.9.3
24. Cladding or Coating	N/A
25. Notes	Needle valve between balls for cavity-pressure relief Max weight 55kg Minimum bore size 10mm







Valve Code	VDE-300-2-S234
Specs	C3
1. Valve Type	Double Ball
2. Sealing Type	Soft
3. Valve Specification Level (VSL)	VSL-2
4. Obturator Type	Trunnion
5. Standard	API 6D
6. Size Range (NPS)	3" - 8"
7. End Connection	RF
8. Pressure Class	300
9. Temperature	-46°C to 150°C
10. Material Class	Stainless Steel
11. Body Material	ASTM A182 Gr F316 or ASTM A351 Gr CF8M + Inconel 625 weld overlay (acc. item A.7.1.7.3)
12. Obturator Material	AISI 316
13. Seat Material	AISI 316
14. Seat Insert Material	PEEK
15. Spring (Seat) Material	UNS N07750
16. Stem Material	ASTM A276 (UNS S31600)
17. Seat-Stem Seal	Group E (acc. item A.7.1.5.6)
18. Operator Type	3" Lever 4" - 8" Gearbox
19. Additional Requirement	N/A
20. Seat Type	(For trunnion-mounted) Side A: SPE / Side B: SPE; DBB
21. Bore Type	Full Bore
22. Body Construction	Compact Flangeless single body double ball valve. Face to face according ASME B16.10
23. Cladding or Coating	Partial clad - Inconel 625 weld overlay on all body sealing areas
24. Valve Testing	FAT according A.9.3
25. Notes	All materials described in this datasheet are required for both valve, Needle valve between balls for cavity-pressure relief

Valve Code	VDE-300-2-S2F1
Specs	C3
1. Valve Type	Double Ball
2. Sealing Type	Soft
3. Valve Specification Level (VSL)	VSL-2
4. Obturator Type	Floating
5. Standard	ASME B16.34
6. Size Range (NPS)	½" - 2"
7. End Connection	Flanged ASME B16.5, RF
8. Pressure Class	300
9. Temperature	-30°C to 150°C
10. Material Class	Stainless Steel
11. Body Material	ASTM A182 Gr F316
12. Obturator Material	AISI 316
13. Seat Material	PTFE reinforced with 25% Carbon
14. Seat Insert Material	N/A
15. Spring Material	N/A
16. Stem Material	ASTM A276 (UNS S31600)
17. Stem Seal Material	Group B (acc. item A.7.1.5.6)
18. Operator Type	Lever
19. Additional Requirement	Fire Tested (acc. item A.6.1.4); Fugitive Emission (acc. item A.6.1.6)
20. Seat Type	N/A
21. Bore Type	Full Bore
22. Body Construction	One piece forged body
23. Product Testing	FAT according A.9.3
24. Cladding or Coating	N/A
25. Notes	Needle valve between balls for cavity-pressure relief Max weight 55kg Minimum bore size 10mm

Valve Code	VDE-300-2-S2F2
Specs	C3
1. Valve Type	Double Ball
2. Sealing Type	Soft
3. Valve Specification Level (VSL)	VSL-2
4. Obturator Type	Floating
5. Standard	ASME B16.34
6. Size Range (NPS)	½" - 2"
7. End Connection	Flanged ASME B16.5, RF x NPT 1/2" ASME B1.20.1
8. Pressure Class	300
9. Temperature	-30°C to 150°C
10. Material Class	Stainless Steel
11. Body Material	ASTM A182 Gr F316
12. Obturator Material	AISI 316
13. Seat Material	PTFE reinforced with 25% Carbon
14. Seat Insert Material	N/A
15. Spring Material	N/A
16. Stem Material	ASTM A276 (UNS S31600)
17. Stem Seal Material	Group B (acc. item A.7.1.5.6)
18. Operator Type	Lever
19. Additional Requirement	Fire Tested (acc. item A.6.1.4); Fugitive Emission (acc. item A.6.1.6)
20. Seat Type	N/A
21. Bore Type	Full Bore
22. Body Construction	One piece forged body
23. Product Testing	FAT according A.9.3
24. Cladding or Coating	N/A
25. Notes	Needle valve between balls for cavity-pressure relief Max weight 55kg Minimum bore size 10mm

Valve Code	VDE-300-2-S2F3
Specs	C3
1. Valve Type	Double Ball
2. Sealing Type	Soft
3. Valve Specification Level (VSL)	VSL-2
4. Obturator Type	Floating
5. Standard	ASME B16.34
6. Size Range (NPS)	½" - 2"
7. End Connection	Flanged ASME B16.5, RF
8. Pressure Class	300
9. Temperature	-100°C to 150°C
10. Material Class	Stainless Steel
11. Body Material	ASTM A182 Gr F316
12. Obturator Material	AISI 316
13. Seat Material	PTFE reinforced with 25% Carbon
14. Seat Insert Material	N/A
15. Spring Material	N/A
16. Stem Material	ASTM A276 (UNS S31600)
17. Stem Seal Material	Group E (acc. item A.7.1.5.6)
18. Operator Type	Lever
19. Additional Requirement	Fire Tested (acc. item A.6.1.4); Fugitive Emission (acc. item A.6.1.6)
20. Seat Type	N/A
21. Bore Type	Full Bore
22. Body Construction	One piece forged body
23. Product Testing	FAT according A.9.3
24. Cladding or Coating	N/A
25. Notes	Needle valve between balls for cavity-pressure relief Max weight 55kg Minimum bore size 10mm

Valve Code	VDE-300-2-S2F4
Specs	C3
1. Valve Type	Double Ball
2. Sealing Type	Soft
3. Valve Specification Level (VSL)	VSL-2
4. Obturator Type	Floating
5. Standard	ASME B16.34
6. Size Range (NPS)	½" - 2"
7. End Connection	Flanged ASME B16.5, RF x NPT 1/2" ASME B1.20.1
8. Pressure Class	300
9. Temperature	-100°C to 150°C
10. Material Class	Stainless Steel
11. Body Material	ASTM A182 Gr F316
12. Obturator Material	AISI 316
13. Seat Material	PTFE reinforced with 25% Carbon
14. Seat Insert Material	N/A
15. Spring Material	N/A
16. Stem Material	ASTM A276 (UNS S31600)
17. Stem Seal Material	Group E (acc. item A.7.1.5.6)
18. Operator Type	Lever
19. Additional Requirement	Fire Tested (acc. item A.6.1.4); Fugitive Emission (acc. item A.6.1.6)
20. Seat Type	N/A
21. Bore Type	Full Bore
22. Body Construction	One piece forged body
23. Product Testing	FAT according A.9.3
24. Cladding or Coating	N/A
25. Notes	Needle valve between balls for cavity-pressure relief Max weight 55kg Minimum bore size 10mm

Valve Code	VDE-300-2-S2F5
Specs	C3
1. Valve Type	Double Ball
2. Sealing Type	Metal to Metal
3. Valve Specification Level (VSL)	VSL-2
4. Obturator Type	Floating
5. Standard	ASME B16.34
6. Size Range (NPS)	½" - 2"
7. End Connection	Flanged ASME B16.5, RF
8. Pressure Class	300
9. Temperature	-100°C to 200°C
10. Material Class	Stainless Steel
11. Body Material	ASTM A182 Gr F316
12. Obturator Material	AISI 316
13. Seat Material	AISI 316
14. Seat Insert Material	N/A
15. Spring Material	N/A
16. Stem Material	ASTM A276 (UNS S31600)
17. Stem Seal Material	Group E (acc. item A.7.1.5.6)
18. Operator Type	Lever
19. Additional Requirement	Fire Tested (acc. item A.6.1.4); Fugitive Emission (acc. item A.6.1.6)
20. Seat Type	N/A
21. Bore Type	Full Bore
22. Body Construction	One piece forged body
23. Product Testing	FAT according A.9.3
24. Cladding or Coating	N/A
25. Notes	Needle valve between balls for cavity-pressure relief Max weight 55kg Minimum bore size 10mm

Valve Code	VDE-300-2-S2F6
Specs	C3
1. Valve Type	Double Ball
2. Sealing Type	Metal to Metal
3. Valve Specification Level (VSL)	VSL-2
4. Obturator Type	Floating
5. Standard	ASME B16.34
6. Size Range (NPS)	½" - 2"
7. End Connection	Flanged ASME B16.5, RF x NPT 1/2" ASME B1.20.1
8. Pressure Class	300
9. Temperature	-100°C to 200°C
10. Material Class	Stainless Steel
11. Body Material	ASTM A182 Gr F316
12. Obturator Material	AISI 316
13. Seat Material	AISI 316
14. Seat Insert Material	N/A
15. Spring Material	N/A
16. Stem Material	ASTM A276 (UNS S31600)
17. Stem Seal Material	Group E (acc. item A.7.1.5.6)
18. Operator Type	Lever
19. Additional Requirement	Fire Tested (acc. item A.6.1.4); Fugitive Emission (acc. item A.6.1.6)
20. Seat Type	N/A
21. Bore Type	Full Bore
22. Body Construction	One piece forged body
23. Product Testing	FAT according A.9.3
24. Cladding or Coating	N/A
25. Notes	Needle valve between balls for cavity-pressure relief Max weight 55kg Minimum bore size 10mm

Valve Code	VDE-300-2-S2F7
Specs	C3
1. Valve Type	Double Ball
2. Sealing Type	Metal to Metal
3. Valve Specification Level (VSL)	VSL-2
4. Obturator Type	Floating
5. Standard	ASME B16.34
6. Size Range (NPS)	½" - 2"
7. End Connection	Flanged ASME B16.5, RF
8. Pressure Class	300
9. Temperature	-100°C to 340°C
10. Material Class	Stainless Steel
11. Body Material	ASTM A182 Gr F316
12. Obturator Material	AISI 316
13. Seat Material	AISI 316
14. Seat Insert Material	N/A
15. Spring Material	N/A
16. Stem Material	ASTM A276 (UNS S31600)
17. Stem Seal Material	Group F (acc. item A.7.1.5.6)
18. Operator Type	Lever
19. Additional Requirement	Fire Tested (acc. item A.6.1.4); Fugitive Emission (acc. item A.6.1.6)
20. Seat Type	N/A
21. Bore Type	Full Bore
22. Body Construction	One piece forged body
23. Product Testing	FAT according A.9.3
24. Cladding or Coating	N/A
25. Notes	Needle valve between balls for cavity-pressure relief Max weight 55kg Minimum bore size 10mm

Valve Code	VDE-300-2-S2F8
Specs	C3
1. Valve Type	Double Ball
2. Sealing Type	Metal to Metal
3. Valve Specification Level (VSL)	VSL-2
4. Obturator Type	Floating
5. Standard	ASME B16.34
6. Size Range (NPS)	½" - 2"
7. End Connection	Flanged ASME B16.5, RF x NPT 1/2" ASME B1.20.1
8. Pressure Class	300
9. Temperature	-100°C to 340°C
10. Material Class	Stainless Steel
11. Body Material	ASTM A182 Gr F316
12. Obturator Material	AISI 316
13. Seat Material	AISI 316
14. Seat Insert Material	N/A
15. Spring Material	N/A
16. Stem Material	ASTM A276 (UNS S31600)
17. Stem Seal Material	Group F (acc. item A.7.1.5.6)
18. Operator Type	Lever
19. Additional Requirement	Fire Tested (acc. item A.6.1.4); Fugitive Emission (acc. item A.6.1.6)
20. Seat Type	N/A
21. Bore Type	Full Bore
22. Body Construction	One piece forged body
23. Product Testing	FAT according A.9.3
24. Cladding or Coating	N/A
25. Notes	Needle valve between balls for cavity-pressure relief Max weight 55kg Minimum bore size 10mm

Valve Code	VDE-600-2-C101
Specs	E34
1. Valve Type	Double Ball
2. Sealing Type	Soft
3. Valve Specification Level (VSL)	VSL-2
4. Obturator Type	Floating
5. Standard	ASME B16.34
6. Size Range (NPS)	½" - 2"
7. End Connection	Flanged ASME B16.5, RF
8. Pressure Class	600
9. Temperature	-29°C to 150°C
10. Material Class	Carbon Steel
11. Body Material	ASTM A105
12. Obturator Material	AISI 410
13. Seat Material	PEEK
14. Seat Insert Material	N/A
15. Spring Material	N/A
16. Stem Material	ASTM A276 (UNS S31600)
17. Stem Seal Material	Group B (acc. item A.7.1.5.6)
18. Operator Type	Lever
19. Additional Requirement	Fire Tested (acc. item A.6.1.4)
20. Seat Type	N/A
21. Bore Type	Full Bore
22. Body Construction	One piece forged body
23. Product Testing	FAT according A.9.3
24. Cladding or Coating	N/A
25. Notes	Needle valve between balls for cavity-pressure relief Max weight 55kg Minimum bore size 10mm

Valve Code	VDE-600-2-C102
Specs	E34
1. Valve Type	Double Ball
2. Sealing Type	Soft
3. Valve Specification Level (VSL)	VSL-2
4. Obturator Type	Floating
5. Standard	ASME B16.34
6. Size Range (NPS)	½" - 2"
7. End Connection	Flanged ASME B16.5, RF x NPT 1/2" ASME B1.20.1
8. Pressure Class	600
9. Temperature	-29°C to 150°C
10. Material Class	Carbon Steel
11. Body Material	ASTM A105
12. Obturator Material	AISI 410
13. Seat Material	PEEK
14. Seat Insert Material	N/A
15. Spring Material	N/A
16. Stem Material	ASTM A276 (UNS S31600)
17. Stem Seal Material	Group B (acc. item A.7.1.5.6)
18. Operator Type	Lever
19. Additional Requirement	Fire Tested (acc. item A.6.1.4)
20. Seat Type	N/A
21. Bore Type	Full Bore
22. Body Construction	One piece forged body
23. Product Testing	FAT according A.9.3
24. Cladding or Coating	N/A
25. Notes	Needle valve between balls for cavity-pressure relief Max weight 55kg Minimum bore size 10mm

Valve Code	VDE-600-2-C103
Specs	E34
1. Valve Type	Double Ball
2. Sealing Type	Soft
3. Valve Specification Level (VSL)	VSL-2
4. Obturator Type	Floating
5. Standard	ASME B16.34
6. Size Range (NPS)	½" - 2"
7. End Connection	Flanged ASME B16.5, RF
8. Pressure Class	600
9. Temperature	-29°C to 150°C
10. Material Class	Carbon Steel
11. Body Material	ASTM A105
12. Obturator Material	AISI 410
13. Seat Material	PEEK
14. Seat Insert Material	N/A
15. Spring Material	N/A
16. Stem Material	ASTM A276 (UNS S31600)
17. Stem Seal Material	Group E (acc. item A.7.1.5.6)
18. Operator Type	Lever
19. Additional Requirement	Fire Tested (acc. item A.6.1.4)
20. Seat Type	N/A
21. Bore Type	Full Bore
22. Body Construction	One piece forged body
23. Product Testing	FAT according A.9.3
24. Cladding or Coating	N/A
25. Notes	Needle valve between balls for cavity-pressure relief Max weight 55kg Minimum bore size 10mm

Valve Code	VDE-600-2-C104
Specs	E34
1. Valve Type	Double Ball
2. Sealing Type	Soft
3. Valve Specification Level (VSL)	VSL-2
4. Obturator Type	Floating
5. Standard	ASME B16.34
6. Size Range (NPS)	½" - 2"
7. End Connection	Flanged ASME B16.5, RF x NPT 1/2" ASME B1.20.1
8. Pressure Class	600
9. Temperature	-29°C to 150°C
10. Material Class	Carbon Steel
11. Body Material	ASTM A105
12. Obturator Material	AISI 410
13. Seat Material	PEEK
14. Seat Insert Material	N/A
15. Spring Material	N/A
16. Stem Material	ASTM A276 (UNS S31600)
17. Stem Seal Material	Group E (acc. item A.7.1.5.6)
18. Operator Type	Lever
19. Additional Requirement	Fire Tested (acc. item A.6.1.4)
20. Seat Type	N/A
21. Bore Type	Full Bore
22. Body Construction	One piece forged body
23. Product Testing	FAT according A.9.3
24. Cladding or Coating	N/A
25. Notes	Needle valve between balls for cavity-pressure relief Max weight 55kg Minimum bore size 10mm

Valve Code	VDE-600-2-C105
Specs	E34
1. Valve Type	Double Ball
2. Sealing Type	Metal to Metal
3. Valve Specification Level (VSL)	VSL-2
4. Obturator Type	Floating
5. Standard	ASME B16.34
6. Size Range (NPS)	½" - 2"
7. End Connection	Flanged ASME B16.5, RF
8. Pressure Class	600
9. Temperature	-29°C to 200°C
10. Material Class	Carbon Steel
11. Body Material	ASTM A105
12. Obturator Material	AISI 410 + Hard Coating (acc. item A.7.1.7.4)
13. Seat Material	AISI 316 + Hard Coating (acc. item A.7.1.7.4)
14. Seat Insert Material	N/A
15. Spring Material	N/A
16. Stem Material	ASTM A276 (UNS S31600)
17. Stem Seal Material	Group E (acc. item A.7.1.5.6)
18. Operator Type	Lever
19. Additional Requirement	Fire Tested (acc. item A.6.1.4)
20. Seat Type	N/A
21. Bore Type	Full Bore
22. Body Construction	One piece forged body
23. Product Testing	FAT according A.9.3
24. Cladding or Coating	N/A
25. Notes	Needle valve between balls for cavity-pressure relief Max weight 55kg Minimum bore size 10mm

Valve Code	VDE-600-2-C106
Specs	E34
1. Valve Type	Double Ball
2. Sealing Type	Metal to Metal
3. Valve Specification Level (VSL)	VSL-2
4. Obturator Type	Floating
5. Standard	ASME B16.34
6. Size Range (NPS)	½" - 2"
7. End Connection	Flanged ASME B16.5, RF x NPT 1/2" ASME B1.20.1
8. Pressure Class	600
9. Temperature	-29°C to 200°C
10. Material Class	Carbon Steel
11. Body Material	ASTM A105
12. Obturator Material	AISI 410 + Hard Coating (acc. item A.7.1.7.4)
13. Seat Material	AISI 316 + Hard Coating (acc. item A.7.1.7.4)
14. Seat Insert Material	N/A
15. Spring Material	N/A
16. Stem Material	ASTM A276 (UNS S31600)
17. Stem Seal Material	Group E (acc. item A.7.1.5.6)
18. Operator Type	Lever
19. Additional Requirement	Fire Tested (acc. item A.6.1.4)
20. Seat Type	N/A
21. Bore Type	Full Bore
22. Body Construction	One piece forged body
23. Product Testing	FAT according A.9.3
24. Cladding or Coating	N/A
25. Notes	Needle valve between balls for cavity-pressure relief Max weight 55kg Minimum bore size 10mm

Valve Code	VDE-600-2-C114
Specs	E34
1. Valve Type	Double Ball
2. Sealing Type	Soft
3. Valve Specification Level (VSL)	VSL-2
4. Ball Mouting	Trunnion
5. Standard	API 6D
6. Size Range (NPS)	3" - 8"
7. End Connection	RF
8. Pressure Class	600
9. Temperature	-29°C to 150°C
10. Material Class	Carbon Steel
11. Body Material	ASTM A105 or ASTM A216 Gr WCB + SS316 weld overlay (acc. item A.7.1.7.3)
12. Obturator Material	AISI 410
13. Seat Material	AISI 410
14. Seat Insert	PEEK
15. Spring (Seat) Material	UNS N07750
16. Stem Material	ASTM A276 (UNS S41000)
17. Seat-Stem Seal	Group B (acc. item A.7.1.5.6)
18. Operator Type	3" Lever 4" - 8" Gearbox
19. Additional Requirement	N/A
20. Seat Type	(For trunnion-mounted) Side A: SPE / Side B: SPE; DBB
21. Bore Type	Full Bore
22. Body Construction	Compact flangeless single body double ball valve. Face to face according ASME B16.10
23. Cladding or Coating	Partial clad - SS316 weld overlay on all body sealing areas
24. Valve Testing	FAT according A.9.3
25. Notes	All materials described in this datasheet are required for both valve, Needle valve between balls for cavity-pressure relief

Valve Code	VDE-600-2-C115
Specs	E34
1. Valve Type	Double Ball
2. Sealing Type	Soft
3. Valve Specification Level (VSL)	VSL-2
4. Ball Mouting	Trunnion
5. Standard	API 6D
6. Size Range (NPS)	3" - 8"
7. End Connection	RF
8. Pressure Class	600
9. Temperature	-29°C to 150°C
10. Material Class	Carbon Steel
11. Body Material	ASTM A105 or ASTM A216 Gr WCB + SS316 weld overlay (acc. item A.7.1.7.3)
12. Obturator Material	AISI 410
13. Seat Material	AISI 410
14. Seat Insert	PEEK
15. Spring (Seat) Material	UNS N07750
16. Stem Material	ASTM A276 (UNS S41000)
17. Seat-Stem Seal	Group B (acc. item A.7.1.5.6)
18. Operator Type	3" Lever 4" - 8" Gearbox
19. Additional Requirement	Fire Tested (acc. item A.6.1.4)
20. Seat Type	(For trunnion-mounted) Side A: SPE / Side B: SPE; DBB
21. Bore Type	Full Bore
22. Body Construction	Compact flangeless single body double ball valve. Face to face according ASME B16.10
23. Cladding or Coating	Partial clad - SS316 weld overlay on all body sealing areas
24. Valve Testing	FAT according A.9.3
25. Notes	All materials described in this datasheet are required for both valve, Needle valve between balls for cavity-pressure relief

Valve Code	VDE-600-2-C11F
Specs	E34
1. Valve Type	Double Ball
2. Sealing Type	Soft
3. Valve Specification Level (VSL)	VSL-2
4. Ball Mouting	Trunnion
5. Standard	API 6D
6. Size Range (NPS)	3" - 8"
7. End Connection	RF
8. Pressure Class	600
9. Temperature	-29°C to 150°C
10. Material Class	Carbon Steel
11. Body Material	ASTM A105 or ASTM A216 Gr WCB + SS316 weld overlay (acc. item A.7.1.7.3)
12. Obturator Material	AISI 410
13. Seat Material	AISI 410
14. Seat Insert	PEEK
15. Spring (Seat) Material	UNS N07750
16. Stem Material	ASTM A276 (UNS S41000)
17. Seat-Stem Seal	Group B (acc. item A.7.1.5.6)
18. Operator Type	3" Lever 4" - 8" Gearbox
19. Additional Requirement	Fire Tested (acc. item A.6.1.4); Fugitive Emission (acc. item A.6.1.6)
20. Seat Type	(For trunnion-mounted) Side A: SPE / Side B: SPE; DBB
21. Bore Type	Full Bore
22. Body Construction	Compact flangeless single body double ball valve. Face to face according ASME B16.10
23. Cladding or Coating	Partial clad - SS316 weld overlay on all body sealing areas
24. Valve Testing	FAT according A.9.3
25. Notes	All materials described in this datasheet are required for both valve, Needle valve between balls for cavity-pressure relief

Valve Code	VDE-600-2-C124
Specs	E34
1. Valve Type	Double Ball
2. Sealing Type	Soft
3. Valve Specification Level (VSL)	VSL-2
4. Ball Mouting	Trunnion
5. Standard	API 6D
6. Size Range (NPS)	3" - 8"
7. End Connection	RF
8. Pressure Class	600
9. Temperature	0°C to 150°C
10. Material Class	Carbon Steel
11. Body Material	ASTM A105 or ASTM A216 Gr WCB + SS316 weld overlay (acc. item A.7.1.7.3)
12. Obturator Material	AISI 410
13. Seat Material	AISI 410
14. Seat Insert	PEEK
15. Spring (Seat) Material	UNS N07750
16. Stem Material	ASTM A276 (UNS S41000)
17. Seat-Stem Seal	Group C (acc. item A.7.1.5.6)
18. Operator Type	3" Lever 4" - 8" Gearbox
19. Additional Requirement	N/A
20. Seat Type	(For trunnion-mounted) Side A: SPE / Side B: SPE; DBB
21. Bore Type	Full Bore
22. Body Construction	Compact flangeless single body double ball valve. Face to face according ASME B16.10
23. Cladding or Coating	Partial clad - SS316 weld overlay on all body sealing areas
24. Valve Testing	FAT according A.9.3
25. Notes	All materials described in this datasheet are required for both valve, Needle valve between balls for cavity-pressure relief

Valve Code	VDE-600-2-C125
Specs	E34
1. Valve Type	Double Ball
2. Sealing Type	Soft
3. Valve Specification Level (VSL)	VSL-2
4. Ball Mouting	Trunnion
5. Standard	API 6D
6. Size Range (NPS)	3" - 8"
7. End Connection	RF
8. Pressure Class	600
9. Temperature	0°C to 150°C
10. Material Class	Carbon Steel
11. Body Material	ASTM A105 or ASTM A216 Gr WCB + SS316 weld overlay (acc. item A.7.1.7.3)
12. Obturator Material	AISI 410
13. Seat Material	AISI 410
14. Seat Insert	PEEK
15. Spring (Seat) Material	UNS N07750
16. Stem Material	ASTM A276 (UNS S41000)
17. Seat-Stem Seal	Group C (acc. item A.7.1.5.6)
18. Operator Type	3" Lever 4" - 8" Gearbox
19. Additional Requirement	Fire Tested (acc. item A.6.1.4)
20. Seat Type	(For trunnion-mounted) Side A: SPE / Side B: SPE; DBB
21. Bore Type	Full Bore
22. Body Construction	Compact flangeless single body double ball valve. Face to face according ASME B16.10
23. Cladding or Coating	Partial clad - SS316 weld overlay on all body sealing areas
24. Valve Testing	FAT according A.9.3
25. Notes	All materials described in this datasheet are required for both valve, Needle valve between balls for cavity-pressure relief





Valve Code	VDE-600-2-C214
Specs	E6 E19
1. Valve Type	Double Ball
2. Sealing Type	Soft
3. Valve Specification Level (VSL)	VSL-2
4. Ball Mouting	Trunnion
5. Standard	API 6D
6. Size Range (NPS)	3" - 8"
7. End Connection	RF
8. Pressure Class	600
9. Temperature	-30°C to 150°C
10. Material Class	Low-Temperature Carbon Steel
11. Body Material	ASTM A350 Gr LF2 CL1 or ASTM A352 Gr LCC + SS316 weld overlay (acc. item A.7.1.7.3)
12. Obturator Material	AISI 316
13. Seat Material	AISI 316
14. Seat Insert	PEEK
15. Spring (Seat) Material	UNS N07750
16. Stem Material	ASTM A276 (UNS S31600)
17. Seat-Stem Seal	Group B (acc. item A.7.1.5.6)
18. Operator Type	3" Lever 4" - 8" Gearbox
19. Additional Requirement	N/A
20. Seat Type	(For trunnion-mounted) Side A: SPE / Side B: SPE; DBB
21. Bore Type	Full Bore
22. Body Construction	Compact flangeless single body double ball valve. Face to face according ASME B16.10
23. Cladding or Coating	Partial clad - SS316 weld overlay on all body sealing areas
24. Valve Testing	FAT according A.9.3
25. Notes	All materials described in this datasheet are required for both valve, Needle valve between balls for cavity-pressure relief

Valve Code	VDE-600-2-C215
Specs	E6 E19
1. Valve Type	Double Ball
2. Sealing Type	Soft
3. Valve Specification Level (VSL)	VSL-2
4. Ball Mouting	Trunnion
5. Standard	API 6D
6. Size Range (NPS)	3" - 8"
7. End Connection	RF
8. Pressure Class	600
9. Temperature	-30°C to 150°C
10. Material Class	Low-Temperature Carbon Steel
11. Body Material	ASTM A350 Gr LF2 CL1 or ASTM A352 Gr LCC + SS316 weld overlay (acc. item A.7.1.7.3)
12. Obturator Material	AISI 316
13. Seat Material	AISI 316
14. Seat Insert	PEEK
15. Spring (Seat) Material	UNS N07750
16. Stem Material	ASTM A276 (UNS S31600)
17. Seat-Stem Seal	Group B (acc. item A.7.1.5.6)
18. Operator Type	3" Lever 4" - 8" Gearbox
19. Additional Requirement	Fire Tested (acc. item A.6.1.4)
20. Seat Type	(For trunnion-mounted) Side A: SPE / Side B: SPE; DBB
21. Bore Type	Full Bore
22. Body Construction	Compact flangeless single body double ball valve. Face to face according ASME B16.10
23. Cladding or Coating	Partial clad - SS316 weld overlay on all body sealing areas
24. Valve Testing	FAT according A.9.3
25. Notes	All materials described in this datasheet are required for both valve, Needle valve between balls for cavity-pressure relief

Valve Code	VDE-600-2-C21F
Specs	E6 E19
1. Valve Type	Double Ball
2. Sealing Type	Soft
3. Valve Specification Level (VSL)	VSL-2
4. Ball Mouting	Trunnion
5. Standard	API 6D
6. Size Range (NPS)	3" - 8"
7. End Connection	RF
8. Pressure Class	600
9. Temperature	-30°C to 150°C
10. Material Class	Low-Temperature Carbon Steel
11. Body Material	ASTM A350 Gr LF2 CL1 or ASTM A352 Gr LCC + SS316 weld overlay (acc. item A.7.1.7.3)
12. Obturator Material	AISI 316
13. Seat Material	AISI 316
14. Seat Insert	PEEK
15. Spring (Seat) Material	UNS N07750
16. Stem Material	ASTM A276 (UNS S31600)
17. Seat-Stem Seal	Group B (acc. item A.7.1.5.6)
18. Operator Type	3" Lever 4" - 8" Gearbox
19. Additional Requirement	Fire Tested (acc. item A.6.1.4); Fugitive Emission (acc. item A.6.1.6)
20. Seat Type	(For trunnion-mounted) Side A: SPE / Side B: SPE; DBB
21. Bore Type	Full Bore
22. Body Construction	Compact flangeless single body double ball valve. Face to face according ASME B16.10
23. Cladding or Coating	Partial clad - SS316 weld overlay on all body sealing areas
24. Valve Testing	FAT according A.9.3
25. Notes	All materials described in this datasheet are required for both valve, Needle valve between balls for cavity-pressure relief

Valve Code	VDE-600-2-C234
Specs	E6 E19
1. Valve Type	Double Ball
2. Sealing Type	Soft
3. Valve Specification Level (VSL)	VSL-2
4. Ball Mouting	Trunnion
5. Standard	API 6D
6. Size Range (NPS)	3" - 8"
7. End Connection	RF
8. Pressure Class	600
9. Temperature	-46°C to 150°C
10. Material Class	Low-Temperature Carbon Steel
11. Body Material	ASTM A350 Gr LF2 CL1 or ASTM A352 Gr LCC + Inconel 625 weld overlay (acc. item A.7.1.7.3)
12. Obturator Material	AISI 316
13. Seat Material	AISI 316
14. Seat Insert	PEEK
15. Spring (Seat) Material	UNS N07750
16. Stem Material	ASTM A276 (UNS S31600)
17. Seat-Stem Seal	Group E (acc. item A.7.1.5.6)
18. Operator Type	3" Lever 4" - 8" Gearbox
19. Additional Requirement	N/A
20. Seat Type	(For trunnion-mounted) Side A: SPE / Side B: SPE; DBB
21. Bore Type	Full Bore
22. Body Construction	Compact flangeless single body double ball valve. Face to face according ASME B16.10
23. Cladding or Coating	Partial clad - Inconel 625 weld overlay on all body sealing areas
24. Valve Testing	FAT according A.9.3
25. Notes	All materials described in this datasheet are required for both valve, Needle valve between balls for cavity-pressure relief

Valve Code	VDE-600-2-C235
Specs	E6 E19
1. Valve Type	Double Ball
2. Sealing Type	Soft
3. Valve Specification Level (VSL)	VSL-2
4. Ball Mouting	Trunnion
5. Standard	API 6D
6. Size Range (NPS)	3" - 8"
7. End Connection	RF
8. Pressure Class	600
9. Temperature	-46°C to 150°C
10. Material Class	Low-Temperature Carbon Steel
11. Body Material	ASTM A350 Gr LF2 CL1 or ASTM A352 Gr LCC + Inconel 625 weld overlay (acc. item A.7.1.7.3)
12. Obturator Material	AISI 316
13. Seat Material	AISI 316
14. Seat Insert	PEEK
15. Spring (Seat) Material	UNS N07750
16. Stem Material	ASTM A276 (UNS S31600)
17. Seat-Stem Seal	Group E (acc. item A.7.1.5.6)
18. Operator Type	3" Lever 4" - 8" Gearbox
19. Additional Requirement	Fire Tested (acc. item A.6.1.4)
20. Seat Type	(For trunnion-mounted) Side A: SPE / Side B: SPE; DBB
21. Bore Type	Full Bore
22. Body Construction	Compact flangeless single body double ball valve. Face to face according ASME B16.10
23. Cladding or Coating	Partial clad - Inconel 625 weld overlay on all body sealing areas
24. Valve Testing	FAT according A.9.3
25. Notes	All materials described in this datasheet are required for both valve, Needle valve between balls for cavity-pressure relief

Valve Code	VDE-600-2-C23F
Specs	E6 E19
1. Valve Type	Double Ball
2. Sealing Type	Soft
3. Valve Specification Level (VSL)	VSL-2
4. Ball Mouting	Trunnion
5. Standard	API 6D
6. Size Range (NPS)	3" - 8"
7. End Connection	RF
8. Pressure Class	600
9. Temperature	-46°C to 150°C
10. Material Class	Low-Temperature Carbon Steel
11. Body Material	ASTM A350 Gr LF2 CL1 or ASTM A352 Gr LCC + Inconel 625 weld overlay (acc. item A.7.1.7.3)
12. Obturator Material	AISI 316
13. Seat Material	AISI 316
14. Seat Insert	PEEK
15. Spring (Seat) Material	UNS N07750
16. Stem Material	ASTM A276 (UNS S31600)
17. Seat-Stem Seal	Group E (acc. item A.7.1.5.6)
18. Operator Type	3" Lever 4" - 8" Gearbox
19. Additional Requirement	Fire Tested (acc. item A.6.1.4); Fugitive Emission (acc. item A.6.1.6)
20. Seat Type	(For trunnion-mounted) Side A: SPE / Side B: SPE; DBB
21. Bore Type	Full Bore
22. Body Construction	Compact flangeless single body double ball valve. Face to face according ASME B16.10
23. Cladding or Coating	Partial clad - Inconel 625 weld overlay on all body sealing areas
24. Valve Testing	FAT according A.9.3
25. Notes	All materials described in this datasheet are required for both valve, Needle valve between balls for cavity-pressure relief

Valve Code	VDE-600-2-C27F
Specs	E19
1. Valve Type	Double Ball
2. Sealing Type	Metal to Metal
3. Valve Specification Level (VSL)	VSL-2
4. Ball Mouting	Trunnion
5. Standard	API 6D
6. Size Range (NPS)	3" - 8"
7. End Connection	RF
8. Pressure Class	600
9. Temperature	-46°C to 200°C
10. Material Class	Low-Temperature Carbon Steel
11. Body Material	ASTM A350 Gr LF2 CL1 or ASTM A352 Gr LCC + Inconel 625 weld overlay (acc. item A.7.1.7.3)
12. Obturator Material	AISI 316 + Tungsten carbide coating
13. Seat Material	AISI 316 + Tungsten carbide coating
14. Seat Insert	N/A
15. Spring (Seat) Material	UNS N07750
16. Stem Material	ASTM A276 (UNS S31600)
17. Seat-Stem Seal	Group E (acc. item A.7.1.5.6)
18. Operator Type	3" Lever 4" - 8" Gearbox
19. Additional Requirement	Fire Tested (acc. item A.6.1.4); Fugitive Emission (acc. item A.6.1.6)
20. Seat Type	(For trunnion-mounted) Side A: SPE / Side B: SPE
21. Bore Type	Full Bore
22. Body Construction	Compact flangeless single body double ball valve. Face to face according ASME B16.10
23. Cladding or Coating	Partial clad - Inconel 625 weld overlay on all body sealing areas
24. Valve Testing	FAT according A.9.3
25. Notes	All materials described in this datasheet are required for both valve, Needle valve between balls for cavity-pressure relief

Valve Code	VDE-600-2-C28F
Specs	E19
1. Valve Type	Double Ball
2. Sealing Type	Metal to Metal
3. Valve Specification Level (VSL)	VSL-2
4. Ball Mouting	Trunnion
5. Standard	API 6D
6. Size Range (NPS)	3" - 8"
7. End Connection	RF
8. Pressure Class	600
9. Temperature	-46°C to 325°C
10. Material Class	Low-Temperature Carbon Steel
11. Body Material	ASTM A350 Gr LF2 CL1 or ASTM A352 Gr LCC + Inconel 625 weld overlay (acc. item A.7.1.7.3)
12. Obturator Material	AISI 316 + Tungsten carbide coating
13. Seat Material	AISI 316 + Tungsten carbide coating
14. Seat Insert	N/A
15. Spring (Seat) Material	UNS N07750
16. Stem Material	ASTM A276 (UNS S31600)
17. Seat-Stem Seal	Group F (acc. item A.7.1.5.6)
18. Operator Type	3" Lever 4" - 8" Gearbox
19. Additional Requirement	Fire Tested (acc. item A.6.1.4); Fugitive Emission (acc. item A.6.1.6)
20. Seat Type	(For trunnion-mounted) Side A: SPE / Side B: SPE
21. Bore Type	Full Bore
22. Body Construction	Compact flangeless single body double ball valve. Face to face according ASME B16.10
23. Cladding or Coating	Partial clad - Inconel 625 weld overlay on all body sealing areas
24. Valve Testing	FAT according A.9.3
25. Notes	All materials described in this datasheet are required for both valve, Needle valve between balls for cavity-pressure relief



Valve Code	VDE-600-2-C2F1
Specs	E6 E19
1. Valve Type	Double Ball
2. Sealing Type	Soft
3. Valve Specification Level (VSL)	VSL-2
4. Obturator Type	Floating
5. Standard	ASME B16.34
6. Size Range (NPS)	½" - 2"
7. End Connection	Flanged ASME B16.5, RF
8. Pressure Class	600
9. Temperature	-30°C to 150°C
10. Material Class	Low-Temperature Carbon Steel
11. Body Material	ASTM A350 Gr LF2 CL1
12. Obturator Material	AISI 316
13. Seat Material	PEEK
14. Seat Insert Material	N/A
15. Spring Material	N/A
16. Stem Material	ASTM A276 (UNS S31600)
17. Stem Seal Material	Group B (acc. item A.7.1.5.6)
18. Operator Type	Lever
19. Additional Requirement	Fire Tested (acc. item A.6.1.4); Fugitive Emission (acc. item A.6.1.6)
20. Seat Type	N/A
21. Bore Type	Full Bore
22. Body Construction	One piece forged body
23. Product Testing	FAT according A.9.3
24. Cladding or Coating	N/A
25. Notes	Needle valve between balls for cavity-pressure relief Max weight 55kg Minimum bore size 10mm

Valve Code	VDE-600-2-C2F2
Specs	E6 E19
1. Valve Type	Double Ball
2. Sealing Type	Soft
3. Valve Specification Level (VSL)	VSL-2
4. Obturator Type	Floating
5. Standard	ASME B16.34
6. Size Range (NPS)	½" - 2"
7. End Connection	Flanged ASME B16.5, RF x NPT 1/2" ASME B1.20.1
8. Pressure Class	600
9. Temperature	-30°C to 150°C
10. Material Class	Low-Temperature Carbon Steel
11. Body Material	ASTM A350 Gr LF2 CL1
12. Obturator Material	AISI 316
13. Seat Material	PEEK
14. Seat Insert Material	N/A
15. Spring Material	N/A
16. Stem Material	ASTM A276 (UNS S31600)
17. Stem Seal Material	Group B (acc. item A.7.1.5.6)
18. Operator Type	Lever
19. Additional Requirement	Fire Tested (acc. item A.6.1.4); Fugitive Emission (acc. item A.6.1.6)
20. Seat Type	N/A
21. Bore Type	Full Bore
22. Body Construction	One piece forged body
23. Product Testing	FAT according A.9.3
24. Cladding or Coating	N/A
25. Notes	Needle valve between balls for cavity-pressure relief Max weight 55kg Minimum bore size 10mm

Valve Code	VDE-600-2-C2F3
Specs	E6 E19
1. Valve Type	Double Ball
2. Sealing Type	Soft
3. Valve Specification Level (VSL)	VSL-2
4. Obturator Type	Floating
5. Standard	ASME B16.34
6. Size Range (NPS)	½" - 2"
7. End Connection	Flanged ASME B16.5, RF
8. Pressure Class	600
9. Temperature	-46°C to 150°C
10. Material Class	Low-Temperature Carbon Steel
11. Body Material	ASTM A350 Gr LF2 CL1
12. Obturator Material	AISI 316
13. Seat Material	PEEK
14. Seat Insert Material	N/A
15. Spring Material	N/A
16. Stem Material	ASTM A276 (UNS S31600)
17. Stem Seal Material	Group E (acc. item A.7.1.5.6)
18. Operator Type	Lever
19. Additional Requirement	Fire Tested (acc. item A.6.1.4); Fugitive Emission (acc. item A.6.1.6)
20. Seat Type	N/A
21. Bore Type	Full Bore
22. Body Construction	One piece forged body
23. Product Testing	FAT according A.9.3
24. Cladding or Coating	N/A
25. Notes	Needle valve between balls for cavity-pressure relief Max weight 55kg Minimum bore size 10mm

Valve Code	VDE-600-2-C2F4
Specs	E6 E19
1. Valve Type	Double Ball
2. Sealing Type	Soft
3. Valve Specification Level (VSL)	VSL-2
4. Obturator Type	Floating
5. Standard	ASME B16.34
6. Size Range (NPS)	½" - 2"
7. End Connection	Flanged ASME B16.5, RF x NPT 1/2" ASME B1.20.1
8. Pressure Class	600
9. Temperature	-46°C to 150°C
10. Material Class	Low-Temperature Carbon Steel
11. Body Material	ASTM A350 Gr LF2 CL1
12. Obturator Material	AISI 316
13. Seat Material	PEEK
14. Seat Insert Material	N/A
15. Spring Material	N/A
16. Stem Material	ASTM A276 (UNS S31600)
17. Stem Seal Material	Group E (acc. item A.7.1.5.6)
18. Operator Type	Lever
19. Additional Requirement	Fire Tested (acc. item A.6.1.4); Fugitive Emission (acc. item A.6.1.6)
20. Seat Type	N/A
21. Bore Type	Full Bore
22. Body Construction	One piece forged body
23. Product Testing	FAT according A.9.3
24. Cladding or Coating	N/A
25. Notes	Needle valve between balls for cavity-pressure relief Max weight 55kg Minimum bore size 10mm

Valve Code	VDE-600-2-C2F5
Specs	E6 E19
1. Valve Type	Double Ball
2. Sealing Type	Metal to Metal
3. Valve Specification Level (VSL)	VSL-2
4. Obturator Type	Floating
5. Standard	ASME B16.34
6. Size Range (NPS)	½" - 2"
7. End Connection	Flanged ASME B16.5, RF
8. Pressure Class	600
9. Temperature	-46°C to 200°C
10. Material Class	Low-Temperature Carbon Steel
11. Body Material	ASTM A350 Gr LF2 CL1
12. Obturator Material	AISI 316 + Hard Coating (acc. item A.7.1.7.4)
13. Seat Material	AISI 316 + Hard Coating (acc. item A.7.1.7.4)
14. Seat Insert Material	N/A
15. Spring Material	N/A
16. Stem Material	ASTM A276 (UNS S31600)
17. Stem Seal Material	Group E (acc. item A.7.1.5.6)
18. Operator Type	Lever
19. Additional Requirement	Fire Tested (acc. item A.6.1.4); Fugitive Emission (acc. item A.6.1.6)
20. Seat Type	N/A
21. Bore Type	Full Bore
22. Body Construction	One piece forged body
23. Product Testing	FAT according A.9.3
24. Cladding or Coating	N/A
25. Notes	Needle valve between balls for cavity-pressure relief Max weight 55kg Minimum bore size 10mm

Valve Code	VDE-600-2-C2F6
Specs	E6 E19
1. Valve Type	Double Ball
2. Sealing Type	Metal to Metal
3. Valve Specification Level (VSL)	VSL-2
4. Obturator Type	Floating
5. Standard	ASME B16.34
6. Size Range (NPS)	½" - 2"
7. End Connection	Flanged ASME B16.5, RF x NPT 1/2" ASME B1.20.1
8. Pressure Class	600
9. Temperature	-46°C to 200°C
10. Material Class	Low-Temperature Carbon Steel
11. Body Material	ASTM A350 Gr LF2 CL1
12. Obturator Material	AISI 316 + Hard Coating (acc. item A.7.1.7.4)
13. Seat Material	AISI 316 + Hard Coating (acc. item A.7.1.7.4)
14. Seat Insert Material	N/A
15. Spring Material	N/A
16. Stem Material	ASTM A276 (UNS S31600)
17. Stem Seal Material	Group E (acc. item A.7.1.5.6)
18. Operator Type	Lever
19. Additional Requirement	Fire Tested (acc. item A.6.1.4); Fugitive Emission (acc. item A.6.1.6)
20. Seat Type	N/A
21. Bore Type	Full Bore
22. Body Construction	One piece forged body
23. Product Testing	FAT according A.9.3
24. Cladding or Coating	N/A
25. Notes	Needle valve between balls for cavity-pressure relief Max weight 55kg Minimum bore size 10mm

Valve Code	VDE-600-2-C2F7
Specs	E19
1. Valve Type	Double Ball
2. Sealing Type	Metal to Metal
3. Valve Specification Level (VSL)	VSL-2
4. Obturator Type	Floating
5. Standard	ISO 17292
6. Size Range (NPS)	½" - 2"
7. End Connection	Flanged ASME B16.5, RF
8. Pressure Class	600
9. Temperature	-46°C to 400°C
10. Material Class	Low-Temperature Carbon Steel
11. Body Material	ASTM A350 Gr LF2 CL1
12. Obturator Material	AISI 316 + Hard Coating (acc. item A.7.1.7.4)
13. Seat Material	ASTM A105 + Hard Coating (acc. item A.7.1.7.4)
14. Seat Insert Material	N/A
15. Spring Material	N/A
16. Stem Material	ASTM A276 (UNS S31600)
17. Stem Seal Material	Group F (acc. item A.7.1.5.6)
18. Operator Type	Lever
19. Additional Requirement	Fire Tested (acc. item A.6.1.4); Fugitive Emission (acc. item A.6.1.6)
20. Seat Type	N/A
21. Bore Type	Full Bore
22. Body Construction	One piece forged body
23. Product Testing	FAT according A.9.3
24. Cladding or Coating	N/A
25. Notes	Acceptance criteria for sealing tests see Annex A.

Valve Code	VDE-600-2-C2F8
Specs	E19
1. Valve Type	Double Ball
2. Sealing Type	Metal to Metal
3. Valve Specification Level (VSL)	VSL-2
4. Obturator Type	Floating
5. Standard	ISO 17292
6. Size Range (NPS)	½" - 2"
7. End Connection	Flanged ASME B16.5, RF x NPT 1/2" ASME B1.20.1
8. Pressure Class	600
9. Temperature	-46°C to 400°C
10. Material Class	Low-Temperature Carbon Steel
11. Body Material	ASTM A350 Gr LF2 CL1
12. Obturator Material	AISI 316 + Hard Coating (acc. item A.7.1.7.4)
13. Seat Material	ASTM A105 + Hard Coating (acc. item A.7.1.7.4)
14. Seat Insert Material	N/A
15. Spring Material	N/A
16. Stem Material	ASTM A276 (UNS S31600)
17. Stem Seal Material	Group F (acc. item A.7.1.5.6)
18. Operator Type	Lever
19. Additional Requirement	Fire Tested (acc. item A.6.1.4); Fugitive Emission (acc. item A.6.1.6)
20. Seat Type	N/A
21. Bore Type	Full Bore
22. Body Construction	One piece forged body
23. Product Testing	FAT according A.9.3
24. Cladding or Coating	N/A
25. Notes	Acceptance criteria for sealing tests see Annex A.

Valve Code	VDE-600-2-C515
Specs	E30
1. Valve Type	Double Ball
2. Sealing Type	Soft
3. Valve Specification Level (VSL)	VSL-2
4. Ball Mounting	Trunnion
5. Standard	API 6D
6. Size Range (NPS)	3" - 8"
7. End Connection	RF
8. Pressure Class	600
9. Temperature	-29°C to 150°C
10. Material Class	Carbon Steel
11. Body Material	ASTM A105 or ASTM A216 Gr WCB + Inconel 625 weld overlay (acc. item A.7.1.7.3)
12. Obturator Material	AISI 316 + Inconel 625 weld overlay (acc. item A.7.1.7.3)
13. Seat Material	AISI 316 + Inconel 625 weld overlay (acc. item A.7.1.7.3)
14. Seat Insert	PEEK
15. Spring (Seat) Material	UNS N07750
16. Stem Material	ASTM B637 (UNS N07718)
17. Seat-Stem Seal	Group B (acc. item A.7.1.5.6)
18. Operator Type	3" Lever 4" - 8" Gearbox
19. Additional Requirement	Fire Tested (acc. item A.6.1.4)
20. Seat Type	(For trunnion-mounted) Side A: SPE / Side B: SPE; DBB
21. Bore Type	Full Bore
22. Body Construction	Compact flangeless single body double ball valve. Face to face according ASME B16.10
23. Cladding or Coating	Full clad - Inconel 625 weld overlay on all wetted parts
24. Valve Testing	FAT according A.9.3
25. Notes	All materials described in this datasheet are required for both valve, Needle valve between balls for cavity-pressure relief

Valve Code	VDE-600-2-C51F
Specs	E30
1. Valve Type	Double Ball
2. Sealing Type	Soft
3. Valve Specification Level (VSL)	VSL-2
4. Ball Mounting	Trunnion
5. Standard	API 6D
6. Size Range (NPS)	3" - 8"
7. End Connection	RF
8. Pressure Class	600
9. Temperature	-29°C to 150°C
10. Material Class	Carbon Steel
11. Body Material	ASTM A105 or ASTM A216 Gr WCB + Inconel 625 weld overlay (acc. item A.7.1.7.3)
12. Obturator Material	AISI 316 + Inconel 625 weld overlay (acc. item A.7.1.7.3)
13. Seat Material	AISI 316 + Inconel 625 weld overlay (acc. item A.7.1.7.3)
14. Seat Insert	PEEK
15. Spring (Seat) Material	UNS N07750
16. Stem Material	ASTM B637 (UNS N07718)
17. Seat-Stem Seal	Group B (acc. item A.7.1.5.6)
18. Operator Type	3" Lever 4" - 8" Gearbox
19. Additional Requirement	Fire Tested (acc. item A.6.1.4); Fugitive Emission (acc. item A.6.1.6)
20. Seat Type	(For trunnion-mounted) Side A: SPE / Side B: SPE; DBB
21. Bore Type	Full Bore
22. Body Construction	Compact flangeless single body double ball valve. Face to face according ASME B16.10
23. Cladding or Coating	Full clad - Inconel 625 weld overlay on all wetted parts
24. Valve Testing	FAT according A.9.3
25. Notes	All materials described in this datasheet are required for both valve, Needle valve between balls for cavity-pressure relief

Valve Code	VDE-600-2-C57F
Specs	E30
1. Valve Type	Double Ball
2. Sealing Type	Metal to Metal
3. Valve Specification Level (VSL)	VSL-2
4. Ball Mounting	Trunnion
5. Standard	API 6D
6. Size Range (NPS)	3" - 8"
7. End Connection	RF
8. Pressure Class	600
9. Temperature	-29°C to 200°C
10. Material Class	Carbon Steel
11. Body Material	ASTM A105 or ASTM A216 Gr WCB + Inconel 625 weld overlay (acc. item A.7.1.7.3)
12. Obturator Material	AISI 316 + Inconel 625 weld overlay (acc. item A.7.1.7.3)
13. Seat Material	AISI 316 + Inconel 625 weld overlay (acc. item A.7.1.7.3)
14. Seat Insert	N/A
15. Spring (Seat) Material	UNS N07750
16. Stem Material	ASTM B637 (UNS N07718)
17. Seat-Stem Seal	Group E (acc. item A.7.1.5.6)
18. Operator Type	3" Lever 4" - 8" Gearbox
19. Additional Requirement	Fire Tested (acc. item A.6.1.4); Fugitive Emission (acc. item A.6.1.6)
20. Seat Type	(For trunnion-mounted) Side A: SPE / Side B: SPE
21. Bore Type	Full Bore
22. Body Construction	Compact flangeless single body double ball valve. Face to face according ASME B16.10
23. Cladding or Coating	Full clad - Inconel 625 weld overlay on all wetted parts
24. Valve Testing	FAT according A.9.3
25. Notes	All materials described in this datasheet are required for both valve, Needle valve between balls for cavity-pressure relief

Valve Code	VDE-600-2-D201
Specs	E16
1. Valve Type	Double Ball
2. Sealing Type	Soft
3. Valve Specification Level (VSL)	VSL-2
4. Obturator Type	Floating
5. Standard	ASME B16.34
6. Size Range (NPS)	½" - 2"
7. End Connection	Flanged ASME B16.5, RTJ
8. Pressure Class	600
9. Temperature	-30°C to 150°C
10. Material Class	Duplex Steel
11. Body Material	ASTM A182 Gr F51
12. Obturator Material	Duplex (UNS S31803)
13. Seat Material	PEEK
14. Seat Insert Material	N/A
15. Spring Material	N/A
16. Stem Material	ASTM A276 (UNS S31803)
17. Stem Seal Material	Group B (acc. item A.7.1.5.6)
18. Operator Type	Lever
19. Additional Requirement	Fire Tested (acc. item A.6.1.4)
20. Seat Type	N/A
21. Bore Type	Full Bore
22. Body Construction	One piece forged body
23. Product Testing	FAT according A.9.3
24. Cladding or Coating	N/A
25. Notes	Needle valve between balls for cavity-pressure relief Max weight 55kg Minimum bore size 10mm



















Valve Code	VDE-900-2-C2F1
Specs	F6
1. Valve Type	Double Ball
2. Sealing Type	Soft
3. Valve Specification Level (VSL)	VSL-2
4. Obturator Type	Floating
5. Standard	ASME B16.34
6. Size Range (NPS)	½" - 2"
7. End Connection	Flanged ASME B16.5, RTJ
8. Pressure Class	900
9. Temperature	-30°C to 150°C
10. Material Class	Low-Temperature Carbon Steel
11. Body Material	ASTM A350 Gr LF2 CL1
12. Obturator Material	AISI 316
13. Seat Material	PEEK
14. Seat Insert Material	N/A
15. Spring Material	N/A
16. Stem Material	ASTM A276 (UNS S31600)
17. Stem Seal Material	Group B (acc. item A.7.1.5.6)
18. Operator Type	Lever
19. Additional Requirement	Fire Tested (acc. item A.6.1.4); Fugitive Emission (acc. item A.6.1.6)
20. Seat Type	N/A
21. Bore Type	Full Bore
22. Body Construction	One piece forged body
23. Product Testing	FAT according A.9.3
24. Cladding or Coating	N/A
25. Notes	Needle valve between balls for cavity-pressure relief Max weight 55kg Minimum bore size 10mm

Valve Code	VDE-900-2-C2F2
Specs	F6
1. Valve Type	Double Ball
2. Sealing Type	Soft
3. Valve Specification Level (VSL)	VSL-2
4. Obturator Type	Floating
5. Standard	ASME B16.34
6. Size Range (NPS)	½" - 2"
7. End Connection	Flanged ASME B16.5, RTJ x NPT 1/2" ASME B1.20.1
8. Pressure Class	900
9. Temperature	-30°C to 150°C
10. Material Class	Low-Temperature Carbon Steel
11. Body Material	ASTM A350 Gr LF2 CL1
12. Obturator Material	AISI 316
13. Seat Material	PEEK
14. Seat Insert Material	N/A
15. Spring Material	N/A
16. Stem Material	ASTM A276 (UNS S31600)
17. Stem Seal Material	Group B (acc. item A.7.1.5.6)
18. Operator Type	Lever
19. Additional Requirement	Fire Tested (acc. item A.6.1.4); Fugitive Emission (acc. item A.6.1.6)
20. Seat Type	N/A
21. Bore Type	Full Bore
22. Body Construction	One piece forged body
23. Product Testing	FAT according A.9.3
24. Cladding or Coating	N/A
25. Notes	Needle valve between balls for cavity-pressure relief Max weight 55kg Minimum bore size 10mm

Valve Code	VDE-900-2-C2F3
Specs	F6
1. Valve Type	Double Ball
2. Sealing Type	Soft
3. Valve Specification Level (VSL)	VSL-2
4. Obturator Type	Floating
5. Standard	ASME B16.34
6. Size Range (NPS)	½" - 2"
7. End Connection	Flanged ASME B16.5, RTJ
8. Pressure Class	900
9. Temperature	-46°C to 150°C
10. Material Class	Low-Temperature Carbon Steel
11. Body Material	ASTM A350 Gr LF2 CL1
12. Obturator Material	AISI 316
13. Seat Material	PEEK
14. Seat Insert Material	N/A
15. Spring Material	N/A
16. Stem Material	ASTM A276 (UNS S31600)
17. Stem Seal Material	Group E (acc. item A.7.1.5.6)
18. Operator Type	Lever
19. Additional Requirement	Fire Tested (acc. item A.6.1.4); Fugitive Emission (acc. item A.6.1.6)
20. Seat Type	N/A
21. Bore Type	Full Bore
22. Body Construction	One piece forged body
23. Product Testing	FAT according A.9.3
24. Cladding or Coating	N/A
25. Notes	Needle valve between balls for cavity-pressure relief Max weight 55kg Minimum bore size 10mm

Valve Code	VDE-900-2-C2F4
Specs	F6
1. Valve Type	Double Ball
2. Sealing Type	Soft
3. Valve Specification Level (VSL)	VSL-2
4. Obturator Type	Floating
5. Standard	ASME B16.34
6. Size Range (NPS)	½" - 2"
7. End Connection	Flanged ASME B16.5, RTJ x NPT 1/2" ASME B1.20.1
8. Pressure Class	900
9. Temperature	-46°C to 150°C
10. Material Class	Low-Temperature Carbon Steel
11. Body Material	ASTM A350 Gr LF2 CL1
12. Obturator Material	AISI 316
13. Seat Material	PEEK
14. Seat Insert Material	N/A
15. Spring Material	N/A
16. Stem Material	ASTM A276 (UNS S31600)
17. Stem Seal Material	Group E (acc. item A.7.1.5.6)
18. Operator Type	Lever
19. Additional Requirement	Fire Tested (acc. item A.6.1.4); Fugitive Emission (acc. item A.6.1.6)
20. Seat Type	N/A
21. Bore Type	Full Bore
22. Body Construction	One piece forged body
23. Product Testing	FAT according A.9.3
24. Cladding or Coating	N/A
25. Notes	Needle valve between balls for cavity-pressure relief Max weight 55kg Minimum bore size 10mm

Valve Code	VDE-900-2-C2F5
Specs	F6
1. Valve Type	Double Ball
2. Sealing Type	Metal to Metal
3. Valve Specification Level (VSL)	VSL-2
4. Obturator Type	Floating
5. Standard	ASME B16.34
6. Size Range (NPS)	½" - 2"
7. End Connection	Flanged ASME B16.5, RTJ
8. Pressure Class	900
9. Temperature	-46°C to 200°C
10. Material Class	Low-Temperature Carbon Steel
11. Body Material	ASTM A350 Gr LF2 CL1
12. Obturator Material	AISI 316 + Hard Coating (acc. item A.7.1.7.4)
13. Seat Material	AISI 316 + Hard Coating (acc. item A.7.1.7.4)
14. Seat Insert Material	N/A
15. Spring Material	N/A
16. Stem Material	ASTM A276 (UNS S31600)
17. Stem Seal Material	Group E (acc. item A.7.1.5.6)
18. Operator Type	Lever
19. Additional Requirement	Fire Tested (acc. item A.6.1.4); Fugitive Emission (acc. item A.6.1.6)
20. Seat Type	N/A
21. Bore Type	Full Bore
22. Body Construction	One piece forged body
23. Product Testing	FAT according A.9.3
24. Cladding or Coating	N/A
25. Notes	Needle valve between balls for cavity-pressure relief Max weight 55kg Minimum bore size 10mm

Valve Code	VDE-900-2-C2F6
Specs	F6
1. Valve Type	Double Ball
2. Sealing Type	Metal to Metal
3. Valve Specification Level (VSL)	VSL-2
4. Obturator Type	Floating
5. Standard	ASME B16.34
6. Size Range (NPS)	½" - 2"
7. End Connection	Flanged ASME B16.5, RTJ x NPT 1/2" ASME B1.20.1
8. Pressure Class	900
9. Temperature	-46°C to 200°C
10. Material Class	Low-Temperature Carbon Steel
11. Body Material	ASTM A350 Gr LF2 CL1
12. Obturator Material	AISI 316 + Hard Coating (acc. item A.7.1.7.4)
13. Seat Material	AISI 316 + Hard Coating (acc. item A.7.1.7.4)
14. Seat Insert Material	N/A
15. Spring Material	N/A
16. Stem Material	ASTM A276 (UNS S31600)
17. Stem Seal Material	Group E (acc. item A.7.1.5.6)
18. Operator Type	Lever
19. Additional Requirement	Fire Tested (acc. item A.6.1.4); Fugitive Emission (acc. item A.6.1.6)
20. Seat Type	N/A
21. Bore Type	Full Bore
22. Body Construction	One piece forged body
23. Product Testing	FAT according A.9.3
24. Cladding or Coating	N/A
25. Notes	Needle valve between balls for cavity-pressure relief Max weight 55kg Minimum bore size 10mm

Valve Code	VDE-900-2-C2F7
Specs	F6
1. Valve Type	Double Ball
2. Sealing Type	Metal to Metal
3. Valve Specification Level (VSL)	VSL-2
4. Obturator Type	Floating
5. Standard	ASME B16.34
6. Size Range (NPS)	½" - 2"
7. End Connection	Flanged ASME B16.5, RTJ
8. Pressure Class	900
9. Temperature	-46°C to 340°C
10. Material Class	Low-Temperature Carbon Steel
11. Body Material	ASTM A350 Gr LF2 CL1
12. Obturator Material	AISI 316 + Hard Coating (acc. item A.7.1.7.4)
13. Seat Material	AISI 316 + Hard Coating (acc. item A.7.1.7.4)
14. Seat Insert Material	N/A
15. Spring Material	N/A
16. Stem Material	ASTM A276 (UNS S31600)
17. Stem Seal Material	Group F (acc. item A.7.1.5.6)
18. Operator Type	Lever
19. Additional Requirement	Fire Tested (acc. item A.6.1.4); Fugitive Emission (acc. item A.6.1.6)
20. Seat Type	N/A
21. Bore Type	Full Bore
22. Body Construction	One piece forged body
23. Product Testing	FAT according A.9.3
24. Cladding or Coating	N/A
25. Notes	Needle valve between balls for cavity-pressure relief Max weight 55kg Minimum bore size 10mm





Valve Code	VGA-150-1-S231
Specs	B3
1. Valve Type	Gate
2. Sealing Type	Metal to Metal
3. Valve Specification Level (VSL)	VSL-1
4. Obturator Type	Flexible wedge, one piece
5. Standard	API 600 / IOGP S-611
6. Size Range (NPS)	2" - 36"
7. End Connection	RF
8. Pressure Class	150
9. Temperature	-46°C to 400°C
10. Material Class	Stainless Steel
11. Body Material	ASTM A182 Gr F316 or ASTM A351 Gr CF8M
12. TRIM Material	TRIM 16 according API
13. Gate Material	AISI 316
14. Seat Material	Stellite (Co-Cr Alloy acc. item A.8.2.1.2)
15. Seat Insert Material	N/A
16. Stem Material	ASTM A276 (UNS S31600)
17. Stem Seal Material	Flexible graphite with inconel wire
18. Seat Seal Material	N/A
19. Operator Type	2" - 10" non rising handwheel 12" - 36" Gearbox
20. Additional Requirement	Fire safe design (acc. item A.6.1.5)
21. Body Construction	bolted bonnet
22. Product Testing	FAT according A.9.3
23. Cladding or Coating	N/A
24. Stem Design	Rising Stem OS&Y

Valve Code	VGA-150-1-U331
Specs	B7
1. Valve Type	Gate
2. Sealing Type	Metal to Metal
3. Valve Specification Level (VSL)	VSL-1
4. Obturator Type	Flexible wedge (NPS>=2), one piece
5. Standard	API 600
6. Size Range (NPS)	1" - 24"
7. End Connection	ASME B16.24, RF
8. Pressure Class	150
9. Temperature	0°C to 90°C
10. Material Class	Uncommon Materials
11. Body Material	ASTM B148 (UNS C95800)
12. TRIM Material	N/A
13. Gate Material	ASTM B148 (UNS C95800)
14. Seat Material	ASTM B148 (UNS C95800)
15. Seat Insert Material	N/A
16. Stem Material	ASTM B150 (UNS C63200)
17. Stem Seal Material	PTFE
18. Seat Seal Material	N/A
19. Operator Type	1" - 10" non rising handwheel 12" - 24" Gearbox
20. Additional Requirement	N/A
21. Body Construction	bolted bonnet
22. Product Testing	FAT according A.9.3
23. Cladding or Coating	N/A
24. Stem Design	Rising Stem OS&Y

Valve Code	VGA-150-1-U332
Specs	B14 B22 B23
1. Valve Type	Gate
2. Sealing Type	Metal to Metal
3. Valve Specification Level (VSL)	VSL-1
4. Obturator Type	Flexible wedge (NPS>=2), one piece
5. Standard	API 600
6. Size Range (NPS)	1" - 24"
7. End Connection	ASME B16.24, FF
8. Pressure Class	150
9. Temperature	0°C to 90°C
10. Material Class	Uncommon Materials
11. Body Material	ASTM B148 (UNS C95800)
12. TRIM Material	N/A
13. Gate Material	ASTM B148 (UNS C95800)
14. Seat Material	ASTM B148 (UNS C95800)
15. Seat Insert Material	N/A
16. Stem Material	ASTM B150 (UNS C63200)
17. Stem Seal Material	PTFE
18. Seat Seal Material	N/A
19. Operator Type	1" - 10" non rising handwheel 12" - 24" Gearbox
20. Additional Requirement	N/A
21. Body Construction	bolted bonnet
22. Product Testing	FAT according A.9.3
23. Cladding or Coating	N/A
24. Stem Design	Rising Stem OS&Y

Valve Code	VGA-150-2-C131
Specs	B4 B9 B10
1. Valve Type	Gate
2. Sealing Type	Metal to Metal
3. Valve Specification Level (VSL)	VSL-2
4. Obturator Type	Flexible wedge, one piece
5. Standard	API 600 / IOGP S-611
6. Size Range (NPS)	2" - 36"
7. End Connection	RF
8. Pressure Class	150
9. Temperature	-29°C to 400°C
10. Material Class	Carbon Steel
11. Body Material	ASTM A105 or ASTM A216 Gr WCB
12. TRIM Material	TRIM 5 according API
13. Gate Material	AISI 410
14. Seat Material	Stellite (Co-Cr Alloy acc. item A.8.2.1.2)
15. Seat Insert Material	N/A
16. Stem Material	ASTM A276 (UNS S41000)
17. Stem Seal Material	Flexible graphite with inconel wire
18. Seat Seal Material	N/A
19. Operator Type	2" - 10" non rising handwheel 12" - 36" Gearbox
20. Additional Requirement	Fire safe design (acc. item A.6.1.5)
21. Body Construction	bolted bonnet
22. Product Testing	FAT according A.9.3
23. Cladding or Coating	N/A
24. Stem Design	Rising Stem OS&Y

Valve Code	VGA-150-2-C132
Specs	B4
1. Valve Type	Gate
2. Sealing Type	Metal to Metal
3. Valve Specification Level (VSL)	VSL-2
4. Obturator Type	Flexible Wedge, one piece
5. Standard	API 600 / IOGP S-611
6. Size Range (NPS)	2" - 36"
7. End Connection	RF
8. Pressure Class	150
9. Temperature	-29°C to 400°C
10. Material Class	Carbon Steel
11. Body Material	ASTM A105 or ASTM A216 Gr WCB
12. TRIM Material	TRIM 8 according API
13. Gate Material	Stellite (Co-Cr Alloy acc. item A.8.2.1.2)
14. Seat Material	Stellite (Co-Cr Alloy acc. item A.8.2.1.2)
15. Seat Insert Material	N/A
16. Stem Material	ASTM A276 (UNS S41000)
17. Stem Seal Material	Flexible graphite with inconel wire
18. Seat Seal Material	N/A
19. Operator Type	2" - 10" non rising handwheel 12" - 36" Gearbox
20. Additional Requirement	Fire safe design (acc. item A.6.1.5)
21. Body Construction	bolted bonnet
22. Product Testing	FAT according A.9.3
23. Cladding or Coating	N/A
24. Stem Design	Rising Stem OS&Y

Valve Code	VGA-150-2-D231
Specs	B11 B16 B26
1. Valve Type	Gate
2. Sealing Type	Metal to Metal
3. Valve Specification Level (VSL)	VSL-2
4. Obturator Type	Flexible Wedge, one piece
5. Standard	API 600 / IOGP S-611
6. Size Range (NPS)	2" - 36"
7. End Connection	RF
8. Pressure Class	150
9. Temperature	-50°C to 150°C
10. Material Class	Duplex Steel
11. Body Material	ASTM A182 Gr F51 or ASTM A995 Gr 4A
12. TRIM Material	N/A
13. Gate Material	(A182 F51 or A995 4A) + E/ERCoCr
14. Seat Material	Duplex (UNS S31803)
15. Seat Insert Material	N/A
16. Stem Material	ASTM A276 (UNS S31803)
17. Stem Seal Material	Flexible graphite with inconel wire
18. Seat Seal Material	N/A
19. Operator Type	2" - 10" non rising handwheel 12" - 36" Gearbox
20. Additional Requirement	Fire safe design (acc. item A.6.1.5)
21. Body Construction	bolted bonnet
22. Product Testing	FAT according A.9.3
23. Cladding or Coating	N/A
24. Stem Design	Rising Stem OS&Y

Valve Code	VGA-150-2-S231
Specs	B3
1. Valve Type	Gate
2. Sealing Type	Metal to Metal
3. Valve Specification Level (VSL)	VSL-2
4. Obturator Type	Flexible Wedge, one piece
5. Standard	API 600 / IOGP S-611
6. Size Range (NPS)	2" - 36"
7. End Connection	RF
8. Pressure Class	150
9. Temperature	-46°C to 400°C
10. Material Class	Stainless Steel
11. Body Material	ASTM A182 Gr F316 or ASTM A351 Gr CF8M
12. TRIM Material	TRIM 16 according API
13. Gate Material	AISI 316
14. Seat Material	Stellite (Co-Cr Alloy acc. item A.8.2.1.2)
15. Seat Insert Material	N/A
16. Stem Material	ASTM A276 (UNS S31600)
17. Stem Seal Material	Flexible graphite with inconel wire
18. Seat Seal Material	N/A
19. Operator Type	2" - 10" non rising handwheel 12" - 36" Gearbox
20. Additional Requirement	Fire safe design (acc. item A.6.1.5)
21. Body Construction	bolted bonnet
22. Product Testing	FAT according A.9.3
23. Cladding or Coating	N/A
24. Stem Design	Rising Stem OS&Y

Valve Code	VGA-150-2-U331
Specs	B7
1. Valve Type	Gate
2. Sealing Type	Metal to Metal
3. Valve Specification Level (VSL)	VSL-2
4. Obturator Type	Flexible Wedge (NPS>=2), one piece
5. Standard	API 600
6. Size Range (NPS)	1" - 24"
7. End Connection	ASME B16.24, RF
8. Pressure Class	150
9. Temperature	0°C to 90°C
10. Material Class	Uncommon Materials
11. Body Material	ASTM B148 (UNS C95800)
12. TRIM Material	N/A
13. Gate Material	ASTM B148 (UNS C95800)
14. Seat Material	ASTM B148 (UNS C95800)
15. Seat Insert Material	N/A
16. Stem Material	ASTM B150 (UNS C63200)
17. Stem Seal Material	PTFE
18. Seat Seal Material	N/A
19. Operator Type	1" - 10" non rising handwheel 12" - 24" Gearbox
20. Additional Requirement	N/A
21. Body Construction	bolted bonnet
22. Product Testing	FAT according A.9.3
23. Cladding or Coating	N/A
24. Stem Design	Rising Stem OS&Y

Valve Code	VGA-150-2-U332
Specs	B14 B22 B23
1. Valve Type	Gate
2. Sealing Type	Metal to Metal
3. Valve Specification Level (VSL)	VSL-2
4. Obturator Type	Flexible Wedge (NPS>=2), one piece
5. Standard	API 600
6. Size Range (NPS)	1" - 24"
7. End Connection	ASME B16.24, FF
8. Pressure Class	150
9. Temperature	0°C to 90°C
10. Material Class	Uncommon Materials
11. Body Material	ASTM B148 (UNS C95800)
12. TRIM Material	N/A
13. Gate Material	ASTM B148 (UNS C95800)
14. Seat Material	ASTM B148 (UNS C95800)
15. Seat Insert Material	N/A
16. Stem Material	ASTM B150 (UNS C63200)
17. Stem Seal Material	PTFE
18. Seat Seal Material	N/A
19. Operator Type	1" - 10" non rising handwheel 12" - 24" Gearbox
20. Additional Requirement	N/A
21. Body Construction	bolted bonnet
22. Product Testing	FAT according A.9.3
23. Cladding or Coating	N/A
24. Stem Design	Rising Stem OS&Y

Valve Code	VGA-2501-1-D201
Specs	H16

Valve Code	VGA-2501-2-D301
Specs	H12P H12

Valve Code	VGA-2510-2-D231
Specs	H16
1. Valve Type	Gate
2. Sealing Type	Metal to Metal
3. Valve Specification Level (VSL)	VSL-2
4. Obturator Type	Flexible Wedge, one piece
5. Standard	API 600 / IOGP S-611
6. Size Range (NPS)	2" - 12"
7. End Connection	ISO 27509, IX
8. Pressure Class	2500
9. Temperature	-50°C to 150°C
10. Material Class	Duplex Steel
11. Body Material	ASTM A182 Gr F51
12. TRIM Material	N/A
13. Gate Material	(A182 F51 or A995 4A) + E/ERCoCr
14. Seat Material	ASTM A182 Gr F51
15. Seat Insert Material	N/A
16. Stem Material	ASTM A276 (UNS S31803)
17. Stem Seal Material	Flexible graphite with inconel wire
18. Seat Seal Material	N/A
19. Operator Type	2" non rising handwheel 3" - 12" Gearbox
20. Additional Requirement	Fire safe design (acc. item A.6.1.5)
21. Body Construction	bolted bonnet
22. Product Testing	FAT according A.9.3
23. Cladding or Coating	N/A
24. Stem Design	Rising Stem OS&Y





A.12.4 GLOBE VALVES

Valve Code	VGL-1500-2-C101
Specs	G10
1. Valve Type	Globe
2. Sealing Type	Metal to Metal
3. Valve Specification Level (VSL)	VSL-2
4. Obturator Type	Bevelled Disc
5. Standard	BS 1873
6. Size Range (NPS)	2" - 14"
7. End Connection	ASME B16.5, RTJ
8. Pressure Class	1500
9. Temperature	-29°C to 400°C
10. Material Class	Carbon Steel
11. Body Material	ASTM A105
12. TRIM Material	TRIM CR 13 and HF according BS 1873
13. Obturator Material	ASTM A182 Gr F6a
14. Seat Material	Stellite (Co-Cr Alloy acc. item A.8.2.1.2)
15. Stem Material	ASTM A276 (UNS S41000)
16. Seat-Stem Seal Material	Flexible graphite with inconel wire
17. Operator Type	2" Rising Handwheel 3" - 14" Gearbox
18. Stem Construction	outside screw stem
19. Bonnet Construction	bolted bonnet
20. Product testing	FAT according A.9.3
21. Coating or Cladding	N/A
22. Notes	N/A
23. Additional Requirement	N/A

Valve Code	VGL-1500-2-C1F1
Specs	G10
1. Valve Type	Globe
2. Sealing Type	Metal to Metal
3. Valve Specification Level (VSL)	VSL-2
4. Obturator Type	Bevelled Disc
5. Standard	BS 1873
6. Size Range (NPS)	2" - 14"
7. End Connection	ASME B16.5, RTJ
8. Pressure Class	1500
9. Temperature	-29°C to 400°C
10. Material Class	Carbon Steel
11. Body Material	ASTM A105
12. TRIM Material	TRIM CR 13 and HF according BS 1873
13. Obturator Material	ASTM A182 Gr F6a
14. Seat Material	Stellite (Co-Cr Alloy acc. item A.8.2.1.2)
15. Stem Material	ASTM A276 (UNS S41000)
16. Seat-Stem Seal Material	Flexible graphite with inconel wire
17. Operator Type	2" Rising Handwheel 3" - 14" Gearbox
18. Stem Construction	outside screw stem
19. Bonnet Construction	bolted bonnet
20. Product testing	FAT according A.9.3
21. Coating or Cladding	N/A
22. Notes	N/A
23. Additional Requirement	Fugitive Emission (acc. item A.6.1.6)

Valve Code	VGL-1500-2-C1F2
Specs	G10
1. Valve Type	Globe
2. Sealing Type	Metal to Metal
3. Valve Specification Level (VSL)	VSL-2
4. Obturator Type	Bevelled Disc
5. Standard	BS 1873
6. Size Range (NPS)	2" - 14"
7. End Connection	ASME B16.5, RTJ
8. Pressure Class	1500
9. Temperature	-29°C to 400°C
10. Material Class	Carbon Steel
11. Body Material	ASTM A105
12. TRIM Material	TRIM HF according BS 1873
13. Obturator Material	Stellite (Co-Cr Alloy acc. item A.8.2.1.2)
14. Seat Material	Stellite (Co-Cr Alloy acc. item A.8.2.1.2)
15. Stem Material	ASTM A276 (UNS S41000)
16. Seat-Stem Seal Material	Flexible graphite with inconel wire
17. Operator Type	2" Rising Handwheel 3" - 14" Gearbox
18. Stem Construction	outside screw stem
19. Bonnet Construction	bolted bonnet
20. Product testing	FAT according A.9.3
21. Coating or Cladding	N/A
22. Notes	N/A
23. Additional Requirement	Fugitive Emission (acc. item A.6.1.6)

Valve Code	VGL-1500-2-D201
Specs	G16P G16
1. Valve Type	Globe
2. Sealing Type	Metal to Metal
3. Valve Specification Level (VSL)	VSL-2
4. Obturator Type	Bevelled Disc
5. Standard	BS 1873
6. Size Range (NPS)	2" - 14"
7. End Connection	ASME B16.5, RTJ
8. Pressure Class	1500
9. Temperature	-46°C to 150°C
10. Material Class	Duplex Steel
11. Body Material	ASTM A182 Gr F51
12. TRIM Material	N/A
13. Obturator Material	ASTM A182 Gr F51
14. Seat Material	ASTM A182 Gr F51
15. Stem Material	ASTM A276 (UNS S31803)
16. Seat-Stem Seal Material	Flexible graphite with inconel wire
17. Operator Type	2" Rising Handwheel 3" - 14" Gearbox
18. Stem Construction	outside screw stem
19. Bonnet Construction	bolted bonnet
20. Product testing	FAT according A.9.3
21. Coating or Cladding	N/A
22. Notes	N/A
23. Additional Requirement	N/A

Valve Code	VGL-1500-2-D2F1
Specs	G16P G16
1. Valve Type	Globe
2. Sealing Type	Metal to Metal
3. Valve Specification Level (VSL)	VSL-2
4. Obturator Type	Bevelled Disc
5. Standard	BS 1873
6. Size Range (NPS)	2" - 14"
7. End Connection	ASME B16.5, RTJ
8. Pressure Class	1500
9. Temperature	-46°C to 150°C
10. Material Class	Duplex Steel
11. Body Material	ASTM A182 Gr F51
12. TRIM Material	N/A
13. Obturator Material	ASTM A182 Gr F51
14. Seat Material	ASTM A182 Gr F51
15. Stem Material	ASTM A276 (UNS S31803)
16. Seat-Stem Seal Material	Flexible graphite with inconel wire
17. Operator Type	2" Rising Handwheel 3" - 14" Gearbox
18. Stem Construction	outside screw stem
19. Bonnet Construction	bolted bonnet
20. Product testing	FAT according A.9.3
21. Coating or Cladding	N/A
22. Notes	N/A
23. Additional Requirement	Fugitive Emission (acc. item A.6.1.6)

Valve Code	VGL-1500-2-S201
Specs	G3
1. Valve Type	Globe
2. Sealing Type	Metal to Metal
3. Valve Specification Level (VSL)	VSL-2
4. Obturator Type	Bevelled Disc
5. Standard	BS 1873
6. Size Range (NPS)	2" - 14"
7. End Connection	ASME B16.5, RTJ
8. Pressure Class	1500
9. Temperature	-46°C to 400°C
10. Material Class	Stainless Steel
11. Body Material	ASTM A182 Gr F316
12. TRIM Material	N/A
13. Obturator Material	ASTM A182 Gr F316
14. Seat Material	Stellite (Co-Cr Alloy acc. item A.8.2.1.2)
15. Stem Material	ASTM A564 Type 630 H1150 (UNS S17400)
16. Seat-Stem Seal Material	Flexible graphite with inconel wire
17. Operator Type	2" Rising Handwheel 3" - 14" Gearbox
18. Stem Construction	outside screw stem
19. Bonnet Construction	bolted bonnet
20. Product testing	FAT according A.9.3
21. Coating or Cladding	N/A
22. Notes	N/A
23. Additional Requirement	N/A

Valve Code	VGL-1500-2-S202
Specs	G3
1. Valve Type	Globe
2. Sealing Type	Metal to Metal
3. Valve Specification Level (VSL)	VSL-2
4. Obturator Type	Bevelled Disc
5. Standard	BS 1873
6. Size Range (NPS)	2" - 14"
7. End Connection	ASME B16.5, RTJ
8. Pressure Class	1500
9. Temperature	-100°C to 400°C
10. Material Class	Stainless Steel
11. Body Material	ASTM A182 Gr F316
12. TRIM Material	N/A (Low Temperature Stem)
13. Obturator Material	ASTM A182 Gr F316
14. Seat Material	Stellite (Co-Cr Alloy acc. item A.8.2.1.2)
15. Stem Material	ASTM B637 (UNS N07718)
16. Seat-Stem Seal Material	Flexible graphite with inconel wire
17. Operator Type	2" Rising Handwheel 3" - 14" Gearbox
18. Stem Construction	outside screw stem
19. Bonnet Construction	bolted bonnet
20. Product testing	FAT according A.9.3
21. Coating or Cladding	N/A
22. Notes	N/A
23. Additional Requirement	N/A

Valve Code	VGL-1500-2-S2F1
Specs	G3
1. Valve Type	Globe
2. Sealing Type	Metal to Metal
3. Valve Specification Level (VSL)	VSL-2
4. Obturator Type	Bevelled Disc
5. Standard	BS 1873
6. Size Range (NPS)	2" - 14"
7. End Connection	ASME B16.5, RTJ
8. Pressure Class	1500
9. Temperature	-46°C to 400°C
10. Material Class	Stainless Steel
11. Body Material	ASTM A182 Gr F316
12. TRIM Material	N/A
13. Obturator Material	ASTM A182 Gr F316
14. Seat Material	Stellite (Co-Cr Alloy acc. item A.8.2.1.2)
15. Stem Material	ASTM A564 Type 630 H1150 (UNS S17400)
16. Seat-Stem Seal Material	Flexible graphite with inconel wire
17. Operator Type	2" Rising Handwheel 3" - 14" Gearbox
18. Stem Construction	outside screw stem
19. Bonnet Construction	bolted bonnet
20. Product testing	FAT according A.9.3
21. Coating or Cladding	N/A
22. Notes	N/A
23. Additional Requirement	Fugitive Emission (acc. item A.6.1.6)

Valve Code	VGL-1500-2-S2F2
Specs	G3
1. Valve Type	Globe
2. Sealing Type	Metal to Metal
3. Valve Specification Level (VSL)	VSL-2
4. Obturator Type	Bevelled Disc
5. Standard	BS 1873
6. Size Range (NPS)	2" - 14"
7. End Connection	ASME B16.5, RTJ
8. Pressure Class	1500
9. Temperature	-100°C to 400°C
10. Material Class	Stainless Steel
11. Body Material	ASTM A182 Gr F316
12. TRIM Material	N/A (Low Temperature Stem)
13. Obturator Material	ASTM A182 Gr F316
14. Seat Material	Stellite (Co-Cr Alloy acc. item A.8.2.1.2)
15. Stem Material	ASTM B637 (UNS N07718)
16. Seat-Stem Seal Material	Flexible graphite with inconel wire
17. Operator Type	2" Rising Handwheel 3" - 14" Gearbox
18. Stem Construction	outside screw stem
19. Bonnet Construction	bolted bonnet
20. Product testing	FAT according A.9.3
21. Coating or Cladding	N/A
22. Notes	N/A
23. Additional Requirement	Fugitive Emission (acc. item A.6.1.6)

Valve Code	VGL-150-1-C101
Specs	B9 B10
1. Valve Type	Globe
2. Sealing Type	Metal to Metal
3. Valve Specification Level (VSL)	VSL-1
4. Obturator Type	Bevelled Disc
5. Standard	API 623
6. Size Range (NPS)	2" - 20"
7. End Connection	ASME B16.5, RF
8. Pressure Class	150
9. Temperature	-29°C to 400°C
10. Material Class	Carbon Steel
11. Body Material	ASTM A105 or ASTM A216 Gr WCB
12. TRIM Material	TRIM CR 13 and HF according BS 1873
13. Obturator Material	AISI 410
14. Seat Material	Stellite (Co-Cr Alloy acc. item A.8.2.1.2)
15. Stem Material	ASTM A276 (UNS S41000)
16. Seat-Stem Seal Material	Flexible graphite with inconel wire
17. Operator Type	2" - 6" Rising Handwheel 8" - 20" Gearbox
18. Stem Construction	outside screw stem
19. Bonnet Construction	bolted bonnet
20. Product testing	FAT according A.9.3
21. Coating or Cladding	N/A
22. Notes	N/A
23. Additional Requirements	N/A

Valve Code	VGL-150-1-C102
Specs	B4
1. Valve Type	Globe
2. Sealing Type	Metal to Metal
3. Valve Specification Level (VSL)	VSL-1
4. Obturator Type	Bevelled Disc
5. Standard	API 623
6. Size Range (NPS)	2" - 18"
7. End Connection	ASME B16.5, RF
8. Pressure Class	150
9. Temperature	-29°C to 400°C
10. Material Class	Carbon Steel
11. Body Material	ASTM A105 or ASTM A216 Gr WCB
12. TRIM Material	TRIM HF according BS 1873
13. Obturator Material	Stellite (Co-Cr Alloy acc. item A.8.2.1.2)
14. Seat Material	Stellite (Co-Cr Alloy acc. item A.8.2.1.2)
15. Stem Material	ASTM A276 (UNS S41000)
16. Seat-Stem Seal Material	Flexible graphite with inconel wire
17. Operator Type	2" - 6" Rising Handwheel 8" - 18" Gearbox
18. Stem Construction	outside screw stem
19. Bonnet Construction	bolted bonnet
20. Product testing	FAT according A.9.3
21. Coating or Cladding	N/A
22. Notes	N/A
23. Additional Requirements	N/A

Valve Code	VGL-150-1-C201
Specs	B6
1. Valve Type	Globe
2. Sealing Type	Metal to Metal
3. Valve Specification Level (VSL)	VSL-1
4. Obturator Type	Bevelled Disc
5. Standard	API 623
6. Size Range (NPS)	2" - 18"
7. End Connection	ASME B16.5, RF
8. Pressure Class	150
9. Temperature	-46°C to 345°C
10. Material Class	Low-Temperature Carbon Steel
11. Body Material	ASTM A350 Gr LF2 CL1 or ASTM A352 Gr LCC
12. TRIM Material	N/A
13. Obturator Material	AISI 316
14. Seat Material	Stellite (Co-Cr Alloy acc. item A.8.2.1.2)
15. Stem Material	ASTM A564 Type 630 H1150 (UNS S17400)
16. Seat-Stem Seal Material	Flexible graphite with inconel wire
17. Operator Type	2" - 6" Rising Handwheel 8" - 18" Gearbox
18. Stem Construction	outside screw stem
19. Bonnet Construction	bolted bonnet
20. Product testing	FAT according A.9.3
21. Coating or Cladding	N/A
22. Notes	N/A
23. Additional Requirements	N/A

Valve Code	VGL-150-1-D201
Specs	B11 B16 B26
1. Valve Type	Globe
2. Sealing Type	Metal to Metal
3. Valve Specification Level (VSL)	VSL-1
4. Obturator Type	Bevelled Disc
5. Standard	API 623
6. Size Range (NPS)	2" - 18"
7. End Connection	ASME B16.5, RF
8. Pressure Class	150
9. Temperature	-46°C to 150°C
10. Material Class	Duplex Steel
11. Body Material	ASTM A182 Gr F51 or ASTM A995 Gr 4A
12. TRIM Material	N/A
13. Obturator Material	Duplex (UNS S31803)
14. Seat Material	Duplex (UNS S31803)
15. Stem Material	ASTM A276 (UNS S31803)
16. Seat-Stem Seal Material	Flexible graphite with inconel wire
17. Operator Type	2" - 6" Rising Handwheel 8" - 18" Gearbox
18. Stem Construction	outside screw stem
19. Bonnet Construction	bolted bonnet
20. Product testing	FAT according A.9.3
21. Coating or Cladding	N/A
22. Notes	N/A
23. Additional Requirements	N/A

Valve Code	VGL-150-1-D301
Specs	B12
1. Valve Type	Globe
2. Sealing Type	Metal to Metal
3. Valve Specification Level (VSL)	VSL-1
4. Obturator Type	Bevelled Disc
5. Standard	API 623
6. Size Range (NPS)	2" - 18"
7. End Connection	ASME B16.5, RF
8. Pressure Class	150
9. Temperature	-46°C to 150°C
10. Material Class	Super Duplex Steel
11. Body Material	ASTM A182 Gr F55 or ASTM A995 Gr 6A
12. TRIM Material	N/A
13. Obturator Material	Super Duplex (UNS S32760)
14. Seat Material	Super Duplex (UNS S32760)
15. Stem Material	ASTM A276 (UNS S32760)
16. Seat-Stem Seal Material	Flexible graphite with inconel wire
17. Operator Type	2" - 6" Rising Handwheel 8" - 18" Gearbox
18. Stem Construction	outside screw stem
19. Bonnet Construction	bolted bonnet
20. Product testing	FAT according A.9.3
21. Coating or Cladding	N/A
22. Notes	N/A
23. Additional Requirements	N/A

Valve Code	VGL-150-1-S201
Specs	B3
1. Valve Type	Globe
2. Sealing Type	Metal to Metal
3. Valve Specification Level (VSL)	VSL-1
4. Obturator Type	Bevelled Disc
5. Standard	API 623
6. Size Range (NPS)	2" - 18"
7. End Connection	ASME B16.5, RF
8. Pressure Class	150
9. Temperature	-29°C to 400°C
10. Material Class	Stainless Steel
11. Body Material	ASTM A182 Gr F316 or ASTM A351 Gr CF8M
12. TRIM Material	N/A
13. Obturator Material	AISI 316
14. Seat Material	Stellite (Co-Cr Alloy acc. item A.8.2.1.2)
15. Stem Material	ASTM A276 (UNS S31600)
16. Seat-Stem Seal Material	Flexible graphite with inconel wire
17. Operator Type	2" - 6" Rising Handwheel 8" - 18" Gearbox
18. Stem Construction	outside screw stem
19. Bonnet Construction	bolted bonnet
20. Product testing	FAT according A.9.3
21. Coating or Cladding	N/A
22. Notes	N/A
23. Additional Requirements	N/A

Valve Code	VGL-150-1-U301
Specs	B7
1. Valve Type	Globe
2. Sealing Type	Metal to Metal
3. Valve Specification Level (VSL)	VSL-1
4. Obturator Type	Bevelled Disc
5. Standard	API 623
6. Size Range (NPS)	2" - 18"
7. End Connection	ASME B16.5, RF
8. Pressure Class	150
9. Temperature	0°C to 90°C
10. Material Class	Uncommon Materials
11. Body Material	ASTM B148 (UNS C95800)
12. TRIM Material	N/A
13. Obturator Material	ASTM B148 (UNS C95800)
14. Seat Material	ASTM B148 (UNS C95800)
15. Stem Material	ASTM B150 (UNS C63200)
16. Seat-Stem Seal Material	According manufacturer standard, fitted to service conditions
17. Operator Type	2" - 6" Rising Handwheel 8" - 18" Gearbox
18. Stem Construction	outside screw stem
19. Bonnet Construction	bolted bonnet
20. Product testing	FAT according A.9.3
21. Coating or Cladding	N/A
22. Notes	N/A
23. Additional Requirements	N/A

Valve Code	VGL-150-1-U302
Specs	B14 B22 B23
1. Valve Type	Globe
2. Sealing Type	Metal to Metal
3. Valve Specification Level (VSL)	VSL-1
4. Obturator Type	Bevelled Disc
5. Standard	API 623
6. Size Range (NPS)	2" - 48"
7. End Connection	ASME B16.24, FF
8. Pressure Class	150
9. Temperature	0°C to 90°C
10. Material Class	Uncommon Materials
11. Body Material	ASTM B148 (UNS C95800)
12. TRIM Material	N/A
13. Obturator Material	ASTM B148 (UNS C95800)
14. Seat Material	ASTM B148 (UNS C95800)
15. Stem Material	ASTM B150 (UNS C63200)
16. Seat-Stem Seal Material	According manufacturer standard, fitted to service conditions
17. Operator Type	2" - 6" Rising Handwheel 8" - 48" Gearbox
18. Stem Construction	outside screw stem
19. Bonnet Construction	bolted bonnet
20. Product testing	FAT according A.9.3
21. Coating or Cladding	N/A
22. Notes	N/A
23. Additional Requirements	N/A

Valve Code	VGL-150-1-U303
Specs	B14 B23
1. Valve Type	Globe
2. Sealing Type	Metal to Metal
3. Valve Specification Level (VSL)	VSL-1
4. Obturator Type	Bevelled Disc
5. Standard	MSS SP-80
6. Size Range (NPS)	1" - 1 1/2"
7. End Connection	ASME B16.24, FF
8. Pressure Class	150
9. Temperature	0°C to 90°C
10. Material Class	Uncommon Materials
11. Body Material	ASTM B148 (UNS C95800)
12. TRIM Material	N/A
13. Obturator Material	ASTM B148 (UNS C95800)
14. Seat Material	ASTM B62 (UNS C83600)
15. Stem Material	ASTM B150 (UNS C63200)
16. Seat-Stem Seal Material	According manufacturer standard, fitted to service conditions
17. Operator Type	Rising Handwheel
18. Stem Construction	outside screw stem
19. Bonnet Construction	union bonnet
20. Product testing	FAT according A.9.3
21. Coating or Cladding	N/A
22. Notes	N/A
23. Additional Requirements	N/A

Valve Code	VGL-150-2-C101
Specs	B9 B10
1. Valve Type	Globe
2. Sealing Type	Metal to Metal
3. Valve Specification Level (VSL)	VSL-2
4. Obturator Type	Bevelled Disc
5. Standard	API 623
6. Size Range (NPS)	2" - 20"
7. End Connection	ASME B16.5, RF
8. Pressure Class	150
9. Temperature	-29°C to 400°C
10. Material Class	Carbon Steel
11. Body Material	ASTM A105 or ASTM A216 Gr WCB
12. TRIM Material	TRIM CR 13 and HF according BS 1873
13. Obturator Material	AISI 410
14. Seat Material	Stellite (Co-Cr Alloy acc. item A.8.2.1.2)
15. Stem Material	ASTM A276 (UNS S41000)
16. Seat-Stem Seal Material	Flexible graphite with inconel wire
17. Operator Type	2" - 6" Rising Handwheel 8" - 20" Gearbox
18. Stem Construction	outside screw stem
19. Bonnet Construction	bolted bonnet
20. Product testing	FAT according A.9.3
21. Coating or Cladding	N/A
22. Notes	N/A
23. Additional Requirements	N/A

Valve Code	VGL-150-2-C102
Specs	B4
1. Valve Type	Globe
2. Sealing Type	Metal to Metal
3. Valve Specification Level (VSL)	VSL-2
4. Obturator Type	Bevelled Disc
5. Standard	API 623
6. Size Range (NPS)	2" - 18"
7. End Connection	ASME B16.5, RF
8. Pressure Class	150
9. Temperature	-29°C to 400°C
10. Material Class	Carbon Steel
11. Body Material	ASTM A105 or ASTM A216 Gr WCB
12. TRIM Material	TRIM HF according BS 1873
13. Obturator Material	Stellite (Co-Cr Alloy acc. item A.8.2.1.2)
14. Seat Material	Stellite (Co-Cr Alloy acc. item A.8.2.1.2)
15. Stem Material	ASTM A276 (UNS S41000)
16. Seat-Stem Seal Material	Flexible graphite with inconel wire
17. Operator Type	2" - 6" Rising Handwheel 8" - 18" Gearbox
18. Stem Construction	outside screw stem
19. Bonnet Construction	bolted bonnet
20. Product testing	FAT according A.9.3
21. Coating or Cladding	N/A
22. Notes	N/A
23. Additional Requirements	N/A

Valve Code	VGL-150-2-C1F1
Specs	B9 B10
1. Valve Type	Globe
2. Sealing Type	Metal to Metal
3. Valve Specification Level (VSL)	VSL-2
4. Obturator Type	Bevelled Disc
5. Standard	API 623
6. Size Range (NPS)	2" - 20"
7. End Connection	ASME B16.5, RF
8. Pressure Class	150
9. Temperature	-29°C to 400°C
10. Material Class	Carbon Steel
11. Body Material	ASTM A105 or ASTM A216 Gr WCB
12. TRIM Material	TRIM CR 13 and HF according BS 1873
13. Obturator Material	AISI 410
14. Seat Material	Stellite (Co-Cr Alloy acc. item A.8.2.1.2)
15. Stem Material	ASTM A276 (UNS S41000)
16. Seat-Stem Seal Material	Flexible graphite with inconel wire
17. Operator Type	2" - 6" Rising Handwheel 8" - 20" Gearbox
18. Stem Construction	outside screw stem
19. Bonnet Construction	bolted bonnet
20. Product testing	FAT according A.9.3
21. Coating or Cladding	N/A
22. Notes	N/A
23. Additional Requirements	Fugitive Emission (acc. item A.6.1.6)

Valve Code	VGL-150-2-C1F2
Specs	B9 B10
1. Valve Type	Globe
2. Sealing Type	Metal to Metal
3. Valve Specification Level (VSL)	VSL-2
4. Obturator Type	Bevelled Disc
5. Standard	API 623
6. Size Range (NPS)	2" - 20"
7. End Connection	ASME B16.5, RF
8. Pressure Class	150
9. Temperature	-29°C to 400°C
10. Material Class	Carbon Steel
11. Body Material	ASTM A105 or ASTM A216 Gr WCB
12. TRIM Material	TRIM HF according BS 1873
13. Obturator Material	Stellite (Co-Cr Alloy acc. item A.8.2.1.2)
14. Seat Material	Stellite (Co-Cr Alloy acc. item A.8.2.1.2)
15. Stem Material	ASTM A276 (UNS S41000)
16. Seat-Stem Seal Material	Flexible graphite with inconel wire
17. Operator Type	2" - 6" Rising Handwheel 8" - 20" Gearbox
18. Stem Construction	outside screw stem
19. Bonnet Construction	bolted bonnet
20. Product testing	FAT according A.9.3
21. Coating or Cladding	N/A
22. Notes	N/A
23. Additional Requirements	Fugitive Emission (acc. item A.6.1.6)

Valve Code	VGL-150-2-C201
Specs	B6
1. Valve Type	Globe
2. Sealing Type	Metal to Metal
3. Valve Specification Level (VSL)	VSL-2
4. Obturator Type	Bevelled Disc
5. Standard	API 623
6. Size Range (NPS)	2" - 18"
7. End Connection	ASME B16.5, RF
8. Pressure Class	150
9. Temperature	-46°C to 345°C
10. Material Class	Low-Temperature Carbon Steel
11. Body Material	ASTM A350 Gr LF2 CL1 or ASTM A352 Gr LCC
12. TRIM Material	N/A
13. Obturator Material	AISI 316
14. Seat Material	Stellite (Co-Cr Alloy acc. item A.8.2.1.2)
15. Stem Material	ASTM A564 Type 630 H1150 (UNS S17400)
16. Seat-Stem Seal Material	Flexible graphite with inconel wire
17. Operator Type	2" - 6" Rising Handwheel 8" - 18" Gearbox
18. Stem Construction	outside screw stem
19. Bonnet Construction	bolted bonnet
20. Product testing	FAT according A.9.3
21. Coating or Cladding	N/A
22. Notes	N/A
23. Additional Requirements	N/A

Valve Code	VGL-150-2-C2F1
Specs	B6
1. Valve Type	Globe
2. Sealing Type	Metal to Metal
3. Valve Specification Level (VSL)	VSL-2
4. Obturator Type	Bevelled Disc
5. Standard	API 623
6. Size Range (NPS)	2" - 18"
7. End Connection	ASME B16.5, RF
8. Pressure Class	150
9. Temperature	-46°C to 345°C
10. Material Class	Low-Temperature Carbon Steel
11. Body Material	ASTM A350 Gr LF2 CL1 or ASTM A352 Gr LCC
12. TRIM Material	N/A
13. Obturator Material	AISI 316
14. Seat Material	Stellite (Co-Cr Alloy acc. item A.8.2.1.2)
15. Stem Material	ASTM A564 Type 630 H1150 (UNS S17400)
16. Seat-Stem Seal Material	Flexible graphite with inconel wire
17. Operator Type	2" - 6" Rising Handwheel 8" - 18" Gearbox
18. Stem Construction	outside screw stem
19. Bonnet Construction	bolted bonnet
20. Product testing	FAT according A.9.3
21. Coating or Cladding	N/A
22. Notes	N/A
23. Additional Requirements	Fugitive Emission (acc. item A.6.1.6)

Valve Code	VGL-150-2-C501
Specs	B30
1. Valve Type	Globe
2. Sealing Type	Metal to Metal
3. Valve Specification Level (VSL)	VSL-2
4. Obturator Type	Bevelled Disc
5. Standard	API 623
6. Size Range (NPS)	2" - 20"
7. End Connection	ASME B16.5, RF
8. Pressure Class	150
9. Temperature	-29°C to 400°C
10. Material Class	Carbon Steel with Cladding
11. Body Material	ASTM A105 or ASTM A216 Gr WCB + Inconel 625 weld overlay (acc. item A.7.1.7.3)
12. TRIM Material	N/A
13. Obturator Material	ASTM A105 + Inconel 625 weld overlay (acc. item A.7.1.7.3)
14. Seat Material	ASTM A105 + Inconel 625 weld overlay (acc. item A.7.1.7.3)
15. Stem Material	ASTM B637 (UNS N07718)
16. Seat-Stem Seal Material	Flexible graphite with inconel wire
17. Operator Type	2" - 6" Rising Handwheel 8" - 20" Gearbox
18. Stem Construction	outside screw stem
19. Bonnet Construction	bolted bonnet
20. Product testing	FAT according A.9.3
21. Coating or Cladding	Full clad - Inconel 625 weld overlay on all wetted parts
22. Notes	N/A
23. Additional Requirements	N/A

Valve Code	VGL-150-2-C5F1
Specs	B30
1. Valve Type	Globe
2. Sealing Type	Metal to Metal
3. Valve Specification Level (VSL)	VSL-2
4. Obturator Type	Bevelled Disc
5. Standard	API 623
6. Size Range (NPS)	2" - 18"
7. End Connection	ASME B16.5, RF
8. Pressure Class	150
9. Temperature	-29°C to 400°C
10. Material Class	Carbon Steel with Cladding
11. Body Material	ASTM A105 or ASTM A216 Gr WCB + Inconel 625 weld overlay (acc. item A.7.1.7.3)
12. TRIM Material	N/A
13. Obturator Material	ASTM A105 + Inconel 625 weld overlay (acc. item A.7.1.7.3)
14. Seat Material	ASTM A105 + Inconel 625 weld overlay (acc. item A.7.1.7.3)
15. Stem Material	ASTM B637 (UNS N07718)
16. Seat-Stem Seal Material	Flexible graphite with inconel wire
17. Operator Type	2" - 6" Rising Handwheel 8" - 18" Gearbox
18. Stem Construction	outside screw stem
19. Bonnet Construction	bolted bonnet
20. Product testing	FAT according A.9.3
21. Coating or Cladding	Full clad - Inconel 625 weld overlay on all wetted parts
22. Notes	N/A
23. Additional Requirements	Fugitive Emission (acc. item A.6.1.6)

Valve Code	VGL-150-2-D101
Specs	B11 B26
1. Valve Type	Globe
2. Sealing Type	Metal to Metal
3. Valve Specification Level (VSL)	VSL-2
4. Obturator Type	Bevelled Disc
5. Standard	API 623
6. Size Range (NPS)	2" - 18"
7. End Connection	ASME B16.5, RF
8. Pressure Class	150
9. Temperature	0°C to 150°C
10. Material Class	Duplex Steel
11. Body Material	ASTM A995 Gr 1b
12. TRIM Material	N/A
13. Obturator Material	Duplex (UNS S32550)
14. Seat Material	Duplex (UNS S32550)
15. Stem Material	ASTM A276 (UNS S32550)
16. Seat-Stem Seal Material	Flexible graphite with inconel wire
17. Operator Type	2" - 6" Rising Handwheel 8" - 18" Gearbox
18. Stem Construction	outside screw stem
19. Bonnet Construction	bolted bonnet
20. Product testing	FAT according A.9.3
21. Coating or Cladding	N/A
22. Notes	N/A
23. Additional Requirements	N/A

Valve Code	VGL-150-2-D201
Specs	B11 B16 B26
1. Valve Type	Globe
2. Sealing Type	Metal to Metal
3. Valve Specification Level (VSL)	VSL-2
4. Obturator Type	Bevelled Disc
5. Standard	API 623
6. Size Range (NPS)	2" - 18"
7. End Connection	ASME B16.5, RF
8. Pressure Class	150
9. Temperature	-46°C to 150°C
10. Material Class	Duplex Steel
11. Body Material	ASTM A182 Gr F51 or ASTM A995 Gr 4A
12. TRIM Material	N/A
13. Obturator Material	Duplex (UNS S31803)
14. Seat Material	Duplex (UNS S31803)
15. Stem Material	ASTM A276 (UNS S31803)
16. Seat-Stem Seal Material	Flexible graphite with inconel wire
17. Operator Type	2" - 6" Rising Handwheel 8" - 18" Gearbox
18. Stem Construction	outside screw stem
19. Bonnet Construction	bolted bonnet
20. Product testing	FAT according A.9.3
21. Coating or Cladding	N/A
22. Notes	N/A
23. Additional Requirements	N/A

Valve Code	VGL-150-2-D2F1
Specs	B11 B16
1. Valve Type	Globe
2. Sealing Type	Metal to Metal
3. Valve Specification Level (VSL)	VSL-2
4. Obturator Type	Bevelled Disc
5. Standard	API 623
6. Size Range (NPS)	2" - 18"
7. End Connection	ASME B16.5, RF
8. Pressure Class	150
9. Temperature	-46°C to 150°C
10. Material Class	Duplex Steel
11. Body Material	ASTM A182 Gr F51 or ASTM A995 Gr 4A
12. TRIM Material	N/A
13. Obturator Material	Duplex (UNS S31803)
14. Seat Material	Duplex (UNS S31803)
15. Stem Material	ASTM A276 (UNS S31803)
16. Seat-Stem Seal Material	Flexible graphite with inconel wire
17. Operator Type	2" - 6" Rising Handwheel 8" - 18" Gearbox
18. Stem Construction	outside screw stem
19. Bonnet Construction	bolted bonnet
20. Product testing	FAT according A.9.3
21. Coating or Cladding	N/A
22. Notes	N/A
23. Additional Requirements	Fugitive Emission (acc. item A.6.1.6)

Valve Code	VGL-150-2-D3F1
Specs	B12
1. Valve Type	Globe
2. Sealing Type	Metal to Metal
3. Valve Specification Level (VSL)	VSL-2
4. Obturator Type	Bevelled Disc
5. Standard	API 623
6. Size Range (NPS)	2" - 18"
7. End Connection	ASME B16.5, RF
8. Pressure Class	150
9. Temperature	-46°C to 150°C
10. Material Class	Super Duplex Steel
11. Body Material	ASTM A182 Gr F55 or ASTM A995 Gr 6A
12. TRIM Material	N/A
13. Obturator Material	Super Duplex (UNS S32760)
14. Seat Material	Super Duplex (UNS S32760)
15. Stem Material	ASTM A276 (UNS S32760)
16. Seat-Stem Seal Material	Flexible graphite with inconel wire
17. Operator Type	2" - 6" Rising Handwheel 8" - 18" Gearbox
18. Stem Construction	outside screw stem
19. Bonnet Construction	bolted bonnet
20. Product testing	FAT according A.9.3
21. Coating or Cladding	N/A
22. Notes	N/A
23. Additional Requirements	Fugitive Emission (acc. item A.6.1.6)

Valve Code	VGL-150-2-S201
Specs	B3
1. Valve Type	Globe
2. Sealing Type	Metal to Metal
3. Valve Specification Level (VSL)	VSL-2
4. Obturator Type	Bevelled Disc
5. Standard	API 623
6. Size Range (NPS)	2" - 18"
7. End Connection	ASME B16.5, RF
8. Pressure Class	150
9. Temperature	-100°C to 400°C
10. Material Class	Stainless Steel
11. Body Material	ASTM A182 Gr F316 or ASTM A351 Gr CF8M
12. TRIM Material	N/A
13. Obturator Material	AIISI 316
14. Seat Material	Stellite (Co-Cr Alloy acc. item A.8.2.1.2)
15. Stem Material	ASTM A276 (UNS S31600)
16. Seat-Stem Seal Material	Flexible graphite with inconel wire
17. Operator Type	2" - 6" Rising Handwheel 8" - 18" Gearbox
18. Stem Construction	outside screw stem
19. Bonnet Construction	bolted bonnet
20. Product testing	FAT according A.9.3
21. Coating or Cladding	N/A
22. Notes	N/A
23. Additional Requirements	N/A

Valve Code	VGL-150-2-S2F1
Specs	B3
1. Valve Type	Globe
2. Sealing Type	Metal to Metal
3. Valve Specification Level (VSL)	VSL-2
4. Obturator Type	Bevelled Disc
5. Standard	API 623
6. Size Range (NPS)	2" - 18"
7. End Connection	ASME B16.5, RF
8. Pressure Class	150
9. Temperature	-100°C to 400°C
10. Material Class	Stainless Steel
11. Body Material	ASTM A182 Gr F316 or ASTM A351 Gr CF8M
12. TRIM Material	N/A
13. Obturator Material	AIISI 316
14. Seat Material	Stellite (Co-Cr Alloy acc. item A.8.2.1.2)
15. Stem Material	ASTM A276 (UNS S31600)
16. Seat-Stem Seal Material	Flexible graphite with inconel wire
17. Operator Type	2" - 6" Rising Handwheel 8" - 18" Gearbox
18. Stem Construction	outside screw stem
19. Bonnet Construction	bolted bonnet
20. Product testing	FAT according A.9.3
21. Coating or Cladding	N/A
22. Notes	N/A
23. Additional Requirements	Fugitive Emission (acc. item A.6.1.6)

Valve Code	VGL-150-2-U301
Specs	B7
1. Valve Type	Globe
2. Sealing Type	Metal to Metal
3. Valve Specification Level (VSL)	VSL-2
4. Obturator Type	Bevelled Disc
5. Standard	API 623
6. Size Range (NPS)	2" - 18"
7. End Connection	ASME B16.24, RF
8. Pressure Class	150
9. Temperature	0°C to 90°C
10. Material Class	Uncommon Materials
11. Body Material	ASTM B148 (UNS C95800)
12. TRIM Material	N/A
13. Obturator Material	ASTM B148 (UNS C95800)
14. Seat Material	ASTM B148 (UNS C95800)
15. Stem Material	ASTM B150 (UNS C63200)
16. Seat-Stem Seal Material	According manufacturer standard, fitted to service conditions
17. Operator Type	2" - 6" Rising Handwheel 8" - 18" Gearbox
18. Stem Construction	outside screw stem
19. Bonnet Construction	bolted bonnet
20. Product testing	FAT according A.9.3
21. Coating or Cladding	N/A
22. Notes	N/A
23. Additional Requirements	N/A

Valve Code	VGL-150-2-U302
Specs	B14 B22 B23
1. Valve Type	Globe
2. Sealing Type	Metal to Metal
3. Valve Specification Level (VSL)	VSL-2
4. Obturator Type	Bevelled Disc
5. Standard	API 623
6. Size Range (NPS)	2" - 24"
7. End Connection	ASME B16.24, FF
8. Pressure Class	150
9. Temperature	0°C to 90°C
10. Material Class	Uncommon Materials
11. Body Material	ASTM B148 (UNS C95800)
12. TRIM Material	N/A
13. Obturator Material	ASTM B148 (UNS C95800)
14. Seat Material	ASTM B148 (UNS C95800)
15. Stem Material	ASTM B150 (UNS C63200)
16. Seat-Stem Seal Material	According manufacturer standard, fitted to service conditions
17. Operator Type	2" - 6" Rising Handwheel 8" - 24" Gearbox
18. Stem Construction	outside screw stem
19. Bonnet Construction	bolted bonnet
20. Product testing	FAT according A.9.3
21. Coating or Cladding	N/A
22. Notes	N/A
23. Additional Requirements	N/A

Valve Code	VGL-2500-2-D201
Specs	H16
1. Valve Type	Globe
2. Sealing Type	Metal to Metal
3. Valve Specification Level (VSL)	VSL-2
4. Obturator Type	Bevelled Disc
5. Standard	BS 1873
6. Size Range (NPS)	2" - 12"
7. End Connection	ASME B16.5, RTJ
8. Pressure Class	2500
9. Temperature	-46°C to 150°C
10. Material Class	Duplex Steel
11. Body Material	ASTM A182 Gr F51
12. TRIM Material	N/A
13. Obturator Material	ASTM A182 Gr F51
14. Seat Material	ASTM A182 Gr F51
15. Stem Material	ASTM A276 (UNS S31803)
16. Seat-Stem Seal Material	Flexible graphite with inconel wire
17. Operator Type	2" Rising Handwheel 3" - 12" Gearbox
18. Stem Construction	outside screw stem
19. Bonnet Construction	bolted bonnet
20. Product testing	FAT according A.9.3
21. Coating or Cladding	N/A
22. Notes	N/A
23. Additional Requirement	N/A

Valve Code	VGL-2500-2-D2F1
Specs	H16
1. Valve Type	Globe
2. Sealing Type	Metal to Metal
3. Valve Specification Level (VSL)	VSL-2
4. Obturator Type	Bevelled Disc
5. Standard	BS 1873
6. Size Range (NPS)	2" - 3"
7. End Connection	ASME B16.5, RTJ
8. Pressure Class	2500
9. Temperature	-46°C to 150°C
10. Material Class	Duplex Steel
11. Body Material	ASTM A182 Gr F51
12. TRIM Material	N/A
13. Obturator Material	ASTM A182 Gr F51
14. Seat Material	ASTM A182 Gr F51
15. Stem Material	ASTM A276 (UNS S31803)
16. Seat-Stem Seal Material	Flexible graphite with inconel wire
17. Operator Type	2" Rising Handwheel 3" Gearbox
18. Stem Construction	outside screw stem
19. Bonnet Construction	bolted bonnet
20. Product testing	FAT according A.9.3
21. Coating or Cladding	N/A
22. Notes	N/A
23. Additional Requirement	Fugitive Emission (acc. item A.6.1.6)



Valve Code	VGL-2510-2-C501
Specs	H30
1. Valve Type	Globe
2. Sealing Type	Metal to Metal
3. Valve Specification Level (VSL)	VSL-2
4. Obturator Type	Bevelled Disc
5. Standard	BS 1873
6. Size Range (NPS)	2" - 16"
7. End Connection	ISO 27509, IX
8. Pressure Class	2500
9. Temperature	-29°C to 400°C
10. Material Class	Carbon Steel with Cladding
11. Body Material	ASTM A105 + Inconel 625 weld overlay (acc. item A.7.1.7.3)
12. TRIM Material	N/A
13. Obturator Material	ASTM A105 + Inconel 625 weld overlay (acc. item A.7.1.7.3)
14. Seat Material	ASTM A105 + Inconel 625 weld overlay (acc. item A.7.1.7.3)
15. Stem Material	ASTM B637 (UNS N07718)
16. Seat-Stem Seal Material	Flexible graphite with inconel wire
17. Operator Type	2" Rising Handwheel 3" - 16" Gearbox
18. Stem Construction	outside screw stem
19. Bonnet Construction	bolted bonnet
20. Product testing	FAT according A.9.3
21. Coating or Cladding	Full clad - Inconel 625 weld overlay on all wetted parts
22. Notes	N/A
23. Additional Requirement	N/A

Valve Code	VGL-2510-2-C5F1
Specs	H30
1. Valve Type	Globe
2. Sealing Type	Metal to Metal
3. Valve Specification Level (VSL)	VSL-2
4. Obturator Type	Bevelled Disc
5. Standard	BS 1873
6. Size Range (NPS)	2" - 16"
7. End Connection	ISO 27509, IX
8. Pressure Class	2500
9. Temperature	-29°C to 400°C
10. Material Class	Carbon Steel with Cladding
11. Body Material	ASTM A105 + Inconel 625 weld overlay (acc. item A.7.1.7.3)
12. TRIM Material	N/A
13. Obturator Material	ASTM A105 + Inconel 625 weld overlay (acc. item A.7.1.7.3)
14. Seat Material	ASTM A105 + Inconel 625 weld overlay (acc. item A.7.1.7.3)
15. Stem Material	ASTM B637 (UNS N07718)
16. Seat-Stem Seal Material	Flexible graphite with inconel wire
17. Operator Type	2" Rising Handwheel 3" - 16" Gearbox
18. Stem Construction	outside screw stem
19. Bonnet Construction	bolted bonnet
20. Product testing	FAT according A.9.3
21. Coating or Cladding	Full clad - Inconel 625 weld overlay on all wetted parts
22. Notes	N/A
23. Additional Requirement	Fugitive Emission (acc. item A.6.1.6)

Valve Code	VGL-2510-2-D201
Specs	H16
1. Valve Type	Globe
2. Sealing Type	Metal to Metal
3. Valve Specification Level (VSL)	VSL-2
4. Obturator Type	Bevelled Disc
5. Standard	BS 1873
6. Size Range (NPS)	2" - 12"
7. End Connection	ISO 27509, IX
8. Pressure Class	2500
9. Temperature	-46°C to 150°C
10. Material Class	Duplex Steel
11. Body Material	ASTM A182 Gr F51
12. TRIM Material	N/A
13. Obturator Material	ASTM A182 Gr F51
14. Seat Material	ASTM A182 Gr F51
15. Stem Material	ASTM A276 (UNS S31803)
16. Seat-Stem Seal Material	Flexible graphite with inconel wire
17. Operator Type	2" Rising Handwheel 3" - 12" Gearbox
18. Stem Construction	outside screw stem
19. Bonnet Construction	bolted bonnet
20. Product testing	FAT according A.9.3
21. Coating or Cladding	N/A
22. Notes	N/A
23. Additional Requirement	N/A

Valve Code	VGL-2510-2-D2F1
Specs	H16
1. Valve Type	Globe
2. Sealing Type	Metal to Metal
3. Valve Specification Level (VSL)	VSL-2
4. Obturator Type	Bevelled Disc
5. Standard	BS 1873
6. Size Range (NPS)	4" - 12"
7. End Connection	ISO 27509, IX
8. Pressure Class	2500
9. Temperature	-46°C to 150°C
10. Material Class	Duplex Steel
11. Body Material	ASTM A182 Gr F51
12. TRIM Material	N/A
13. Obturator Material	ASTM A182 Gr F51
14. Seat Material	ASTM A182 Gr F51
15. Stem Material	ASTM A276 (UNS S31803)
16. Seat-Stem Seal Material	Flexible graphite with inconel wire
17. Operator Type	Gearbox
18. Stem Construction	outside screw stem
19. Bonnet Construction	bolted bonnet
20. Product testing	FAT according A.9.3
21. Coating or Cladding	N/A
22. Notes	N/A
23. Additional Requirement	Fugitive Emission (acc. item A.6.1.6)

Valve Code	VGL-2510-2-D301
Specs	H12
1. Valve Type	Globe
2. Sealing Type	Metal to Metal
3. Valve Specification Level (VSL)	VSL-2
4. Obturator Type	Bevelled Disc
5. Standard	BS 1873
6. Size Range (NPS)	2" - 16"
7. End Connection	ISO 27509, IX
8. Pressure Class	2500
9. Temperature	-50°C to 150°C
10. Material Class	Super Duplex Steel
11. Body Material	ASTM A182 Gr F55
12. TRIM Material	N/A
13. Obturator Material	ASTM A182 Gr F55
14. Seat Material	ASTM A182 Gr F55
15. Stem Material	ASTM A276 (UNS S32760)
16. Seat-Stem Seal Material	Flexible graphite with inconel wire
17. Operator Type	2" Rising Handwheel 3" - 16" Gearbox
18. Stem Construction	outside screw stem
19. Bonnet Construction	bolted bonnet
20. Product testing	FAT according A.9.3
21. Coating or Cladding	N/A
22. Notes	N/A
23. Additional Requirement	N/A

Valve Code	VGL-2510-2-D3F1
Specs	H12
1. Valve Type	Globe
2. Sealing Type	Metal to Metal
3. Valve Specification Level (VSL)	VSL-2
4. Obturator Type	Bevelled Disc
5. Standard	BS 1873
6. Size Range (NPS)	2" - 16"
7. End Connection	ISO 27509, IX
8. Pressure Class	2500
9. Temperature	-50°C to 150°C
10. Material Class	Super Duplex Steel
11. Body Material	ASTM A182 Gr F55
12. TRIM Material	N/A
13. Obturator Material	ASTM A182 Gr F55
14. Seat Material	ASTM A182 Gr F55
15. Stem Material	ASTM A276 (UNS S32760)
16. Seat-Stem Seal Material	Flexible graphite with inconel wire
17. Operator Type	2" Rising Handwheel 3" - 16" Gearbox
18. Stem Construction	outside screw stem
19. Bonnet Construction	bolted bonnet
20. Product testing	FAT according A.9.3
21. Coating or Cladding	N/A
22. Notes	N/A
23. Additional Requirement	Fugitive Emission (acc. item A.6.1.6)

Valve Code	VGL-2510-2-S201
Specs	H3
1. Valve Type	Globe
2. Sealing Type	Metal to Metal
3. Valve Specification Level (VSL)	VSL-2
4. Obturator Type	Bevelled Disc
5. Standard	BS 1873
6. Size Range (NPS)	2" - 12"
7. End Connection	ISO 27509, IX
8. Pressure Class	2500
9. Temperature	-46°C to 400°C
10. Material Class	Stainless Steel
11. Body Material	ASTM A182 Gr F316
12. TRIM Material	N/A
13. Obturator Material	ASTM A182 Gr F316
14. Seat Material	Stellite (Co-Cr Alloy acc. item A.8.2.1.2)
15. Stem Material	ASTM A564 Type 630 H1150 (UNS S17400)
16. Seat-Stem Seal Material	Flexible graphite with inconel wire
17. Operator Type	2" Rising Handwheel 3" - 12" Gearbox
18. Stem Construction	outside screw stem
19. Bonnet Construction	bolted bonnet
20. Product testing	FAT according A.9.3
21. Coating or Cladding	N/A
22. Notes	N/A
23. Additional Requirement	N/A

Valve Code	VGL-2510-2-S202
Specs	H3
1. Valve Type	Globe
2. Sealing Type	Metal to Metal
3. Valve Specification Level (VSL)	VSL-2
4. Obturator Type	Bevelled Disc
5. Standard	BS 1873
6. Size Range (NPS)	2" - 12"
7. End Connection	ISO 27509, IX
8. Pressure Class	2500
9. Temperature	-100°C to 400°C
10. Material Class	Stainless Steel
11. Body Material	ASTM A182 Gr F316
12. TRIM Material	N/A (Low Temperature Stem)
13. Obturator Material	ASTM A182 Gr F316
14. Seat Material	Stellite (Co-Cr Alloy acc. item A.8.2.1.2)
15. Stem Material	ASTM B637 (UNS N07718)
16. Seat-Stem Seal Material	Flexible graphite with inconel wire
17. Operator Type	2" Rising Handwheel 3" - 12" Gearbox
18. Stem Construction	outside screw stem
19. Bonnet Construction	bolted bonnet
20. Product testing	FAT according A.9.3
21. Coating or Cladding	N/A
22. Notes	N/A
23. Additional Requirement	N/A

Valve Code	VGL-2510-2-S2F1
Specs	H3
1. Valve Type	Globe
2. Sealing Type	Metal to Metal
3. Valve Specification Level (VSL)	VSL-2
4. Obturator Type	Bevelled Disc
5. Standard	BS 1873
6. Size Range (NPS)	2" - 14"
7. End Connection	ISO 27509, IX
8. Pressure Class	2500
9. Temperature	-46°C to 400°C
10. Material Class	Stainless Steel
11. Body Material	ASTM A182 Gr F316
12. TRIM Material	N/A
13. Obturator Material	ASTM A182 Gr F316
14. Seat Material	Stellite (Co-Cr Alloy acc. item A.8.2.1.2)
15. Stem Material	ASTM A564 Type 630 H1150 (UNS S17400)
16. Seat-Stem Seal Material	Flexible graphite with inconel wire
17. Operator Type	2" Rising Handwheel 3" - 14" Gearbox
18. Stem Construction	outside screw stem
19. Bonnet Construction	bolted bonnet
20. Product testing	FAT according A.9.3
21. Coating or Cladding	N/A
22. Notes	N/A
23. Additional Requirement	Fugitive Emission (acc. item A.6.1.6)

Valve Code	VGL-2510-2-S2F2
Specs	H3
1. Valve Type	Globe
2. Sealing Type	Metal to Metal
3. Valve Specification Level (VSL)	VSL-2
4. Obturator Type	Bevelled Disc
5. Standard	BS 1873
6. Size Range (NPS)	2" - 14"
7. End Connection	ISO 27509, IX
8. Pressure Class	2500
9. Temperature	-100°C to 400°C
10. Material Class	Stainless Steel
11. Body Material	ASTM A182 Gr F316
12. TRIM Material	N/A (Low Temperature Stem)
13. Obturator Material	ASTM A182 Gr F316
14. Seat Material	Stellite (Co-Cr Alloy acc. item A.8.2.1.2)
15. Stem Material	ASTM B637 (UNS N07718)
16. Seat-Stem Seal Material	Flexible graphite with inconel wire
17. Operator Type	2" Rising Handwheel 3" - 14" Gearbox
18. Stem Construction	outside screw stem
19. Bonnet Construction	bolted bonnet
20. Product testing	FAT according A.9.3
21. Coating or Cladding	N/A
22. Notes	N/A
23. Additional Requirement	Fugitive Emission (acc. item A.6.1.6)

Valve Code	VGL-300-1-C101
Specs	C10
1. Valve Type	Globe
2. Sealing Type	Metal to Metal
3. Valve Specification Level (VSL)	VSL-1
4. Obturator Type	Bevelled Disc
5. Standard	API 623
6. Size Range (NPS)	2" - 18"
7. End Connection	ASME B16.5, RF
8. Pressure Class	300
9. Temperature	-29°C to 400°C
10. Material Class	Carbon Steel
11. Body Material	ASTM A105 or ASTM A216 Gr WCB
12. TRIM Material	TRIM CR 13 and HF according BS 1873
13. Obturator Material	ATSI 410
14. Seat Material	Stellite (Co-Cr Alloy acc. item A.8.2.1.2)
15. Stem Material	ASTM A276 (UNS S41000)
16. Seat-Stem Seal Material	Flexible graphite with inconel wire
17. Operator Type	2" - 6" Rising Handwheel 8" - 18" Gearbox
18. Stem Construction	outside screw stem
19. Bonnet Construction	bolted bonnet
20. Product testing	FAT according A.9.3
21. Coating or Cladding	N/A
22. Notes	N/A
23. Additional Requirements	N/A

Valve Code	VGL-300-1-C201
Specs	C6
1. Valve Type	Globe
2. Sealing Type	Metal to Metal
3. Valve Specification Level (VSL)	VSL-1
4. Obturator Type	Bevelled Disc
5. Standard	API 623
6. Size Range (NPS)	2" - 18"
7. End Connection	ASME B16.5, RF
8. Pressure Class	300
9. Temperature	-46°C to 345°C
10. Material Class	Low-Temperature Carbon Steel
11. Body Material	ASTM A350 Gr LF2 CL1 or ASTM A352 Gr LCC
12. TRIM Material	N/A
13. Obturator Material	ATSI 316
14. Seat Material	Stellite (Co-Cr Alloy acc. item A.8.2.1.2)
15. Stem Material	ASTM A564 Type 630 H1150 (UNS S17400)
16. Seat-Stem Seal Material	Flexible graphite with inconel wire
17. Operator Type	2" - 6" Rising Handwheel 8" - 18" Gearbox
18. Stem Construction	outside screw stem
19. Bonnet Construction	bolted bonnet
20. Product testing	FAT according A.9.3
21. Coating or Cladding	N/A
22. Notes	N/A
23. Additional Requirements	N/A



Valve Code	VGL-300-1-C501
Specs	C30
1. Valve Type	Globe
2. Sealing Type	Metal to Metal
3. Valve Specification Level (VSL)	VSL-1
4. Obturator Type	Bevelled Disc
5. Standard	API 623
6. Size Range (NPS)	2" - 20"
7. End Connection	ASME B16.5, RF
8. Pressure Class	300
9. Temperature	-29°C to 400°C
10. Material Class	Carbon Steel with Cladding
11. Body Material	ASTM A105 or ASTM A216 Gr WCB + Inconel 625 weld overlay (acc. item A.7.1.7.3)
12. TRIM Material	N/A
13. Obturator Material	ASTM A105 + Inconel 625 weld overlay (acc. item A.7.1.7.3)
14. Seat Material	ASTM A105 + Inconel 625 weld overlay (acc. item A.7.1.7.3)
15. Stem Material	ASTM B637 (UNS N07718)
16. Seat-Stem Seal Material	Flexible graphite with inconel wire
17. Operator Type	2" - 6" Rising Handwheel 8" - 20" Gearbox
18. Stem Construction	outside screw stem
19. Bonnet Construction	bolted bonnet
20. Product testing	FAT according A.9.3
21. Coating or Cladding	Full clad - Inconel 625 weld overlay on all wetted parts
22. Notes	N/A
23. Additional Requirements	N/A

Valve Code	VGL-300-1-D201
Specs	C11 C16
1. Valve Type	Globe
2. Sealing Type	Metal to Metal
3. Valve Specification Level (VSL)	VSL-1
4. Obturator Type	Bevelled Disc
5. Standard	API 623
6. Size Range (NPS)	2" - 18"
7. End Connection	ASME B16.5, RF
8. Pressure Class	300
9. Temperature	-46°C to 150°C
10. Material Class	Duplex Steel
11. Body Material	ASTM A182 Gr F51 or ASTM A995 Gr 4A
12. TRIM Material	N/A
13. Obturator Material	Duplex (UNS S31803)
14. Seat Material	Duplex (UNS S31803)
15. Stem Material	ASTM A276 (UNS S31803)
16. Seat-Stem Seal Material	Flexible graphite with inconel wire
17. Operator Type	2" - 6" Rising Handwheel 8" - 18" Gearbox
18. Stem Construction	outside screw stem
19. Bonnet Construction	bolted bonnet
20. Product testing	FAT according A.9.3
21. Coating or Cladding	N/A
22. Notes	N/A
23. Additional Requirements	N/A

Valve Code	VGL-300-1-S201
Specs	C3
1. Valve Type	Globe
2. Sealing Type	Metal to Metal
3. Valve Specification Level (VSL)	VSL-1
4. Obturator Type	Bevelled Disc
5. Standard	API 623
6. Size Range (NPS)	2" - 18"
7. End Connection	ASME B16.5, RF
8. Pressure Class	300
9. Temperature	-100°C to 400°C
10. Material Class	Stainless Steel
11. Body Material	ASTM A182 Gr F316 or ASTM A351 Gr CF8M
12. TRIM Material	N/A
13. Obturator Material	AISI 316
14. Seat Material	Stellite (Co-Cr Alloy acc. item A.8.2.1.2)
15. Stem Material	ASTM A276 (UNS S31600)
16. Seat-Stem Seal Material	Flexible graphite with inconel wire
17. Operator Type	2" - 6" Rising Handwheel 8" - 18" Gearbox
18. Stem Construction	outside screw stem
19. Bonnet Construction	bolted bonnet
20. Product testing	FAT according A.9.3
21. Coating or Cladding	N/A
22. Notes	N/A
23. Additional Requirements	N/A

Valve Code	VGL-300-1-U301
Specs	C23
1. Valve Type	Globe
2. Sealing Type	Metal to Metal
3. Valve Specification Level (VSL)	VSL-1
4. Obturator Type	Bevelled Disc
5. Standard	API 623
6. Size Range (NPS)	2" - 12"
7. End Connection	ASME B16.5, RF
8. Pressure Class	300
9. Temperature	0°C to 90°C
10. Material Class	Uncommon Materials
11. Body Material	ASTM B148 (UNS C95800)
12. TRIM Material	N/A
13. Obturator Material	ASTM B148 (UNS C95800)
14. Seat Material	ASTM B148 (UNS C95800)
15. Stem Material	ASTM B150 (UNS C63200)
16. Seat-Stem Seal Material	According manufacturer standard, fitted to service conditions
17. Operator Type	2" - 6" Rising Handwheel 8" - 12" Gearbox
18. Stem Construction	outside screw stem
19. Bonnet Construction	bolted bonnet
20. Product testing	FAT according A.9.3
21. Coating or Cladding	N/A
22. Notes	N/A
23. Additional Requirements	N/A

Valve Code	VGL-300-2-C101
Specs	C10
1. Valve Type	Globe
2. Sealing Type	Metal to Metal
3. Valve Specification Level (VSL)	VSL-2
4. Obturator Type	Bevelled Disc
5. Standard	API 623
6. Size Range (NPS)	2" - 18"
7. End Connection	ASME B16.5, RF
8. Pressure Class	300
9. Temperature	-29°C to 400°C
10. Material Class	Carbon Steel
11. Body Material	ASTM A105 or ASTM A216 Gr WCB
12. TRIM Material	TRIM CR 13 and HF according BS 1873
13. Obturator Material	AISI 410
14. Seat Material	Stellite (Co-Cr Alloy acc. item A.8.2.1.2)
15. Stem Material	ASTM A276 (UNS S41000)
16. Seat-Stem Seal Material	Flexible graphite with inconel wire
17. Operator Type	2" - 6" Rising Handwheel 8" - 18" Gearbox
18. Stem Construction	outside screw stem
19. Bonnet Construction	bolted bonnet
20. Product testing	FAT according A.9.3
21. Coating or Cladding	N/A
22. Notes	N/A
23. Additional Requirements	N/A

Valve Code	VGL-300-2-C1F1
Specs	C10
1. Valve Type	Globe
2. Sealing Type	Metal to Metal
3. Valve Specification Level (VSL)	VSL-2
4. Obturator Type	Bevelled Disc
5. Standard	API 623
6. Size Range (NPS)	2" - 18"
7. End Connection	ASME B16.5, RF
8. Pressure Class	300
9. Temperature	-29°C to 400°C
10. Material Class	Carbon Steel
11. Body Material	ASTM A105 or ASTM A216 Gr WCB
12. TRIM Material	TRIM CR 13 and HF according BS 1873
13. Obturator Material	AISI 410
14. Seat Material	Stellite (Co-Cr Alloy acc. item A.8.2.1.2)
15. Stem Material	ASTM A276 (UNS S41000)
16. Seat-Stem Seal Material	Flexible graphite with inconel wire
17. Operator Type	2" - 6" Rising Handwheel 8" - 18" Gearbox
18. Stem Construction	outside screw stem
19. Bonnet Construction	bolted bonnet
20. Product testing	FAT according A.9.3
21. Coating or Cladding	N/A
22. Notes	N/A
23. Additional Requirements	Fugitive Emission (acc. item A.6.1.6)

Valve Code	VGL-300-2-C1F2
Specs	C10
1. Valve Type	Globe
2. Sealing Type	Metal to Metal
3. Valve Specification Level (VSL)	VSL-2
4. Obturator Type	Bevelled Disc
5. Standard	API 623
6. Size Range (NPS)	2" - 18"
7. End Connection	ASME B16.5, RF
8. Pressure Class	300
9. Temperature	-29°C to 400°C
10. Material Class	Carbon Steel
11. Body Material	ASTM A105 or ASTM A216 Gr WCB
12. TRIM Material	TRIM HF according BS 1873
13. Obturator Material	Stellite (Co-Cr Alloy acc. item A.8.2.1.2)
14. Seat Material	Stellite (Co-Cr Alloy acc. item A.8.2.1.2)
15. Stem Material	ASTM A276 (UNS S41000)
16. Seat-Stem Seal Material	Flexible graphite with inconel wire
17. Operator Type	2" - 6" Rising Handwheel 8" - 18" Gearbox
18. Stem Construction	outside screw stem
19. Bonnet Construction	bolted bonnet
20. Product testing	FAT according A.9.3
21. Coating or Cladding	N/A
22. Notes	N/A
23. Additional Requirements	Fugitive Emission (acc. item A.6.1.6)

Valve Code	VGL-300-2-C201
Specs	C6
1. Valve Type	Globe
2. Sealing Type	Metal to Metal
3. Valve Specification Level (VSL)	VSL-2
4. Obturator Type	Bevelled Disc
5. Standard	API 623
6. Size Range (NPS)	2" - 18"
7. End Connection	ASME B16.5, RF
8. Pressure Class	300
9. Temperature	-46°C to 345°C
10. Material Class	Low-Temperature Carbon Steel
11. Body Material	ASTM A350 Gr LF2 CL1 or ASTM A352 Gr LCC
12. TRIM Material	N/A
13. Obturator Material	AISI 316
14. Seat Material	Stellite (Co-Cr Alloy acc. item A.8.2.1.2)
15. Stem Material	ASTM A564 Type 630 H1150 (UNS S17400)
16. Seat-Stem Seal Material	Flexible graphite with inconel wire
17. Operator Type	2" - 6" Rising Handwheel 8" - 18" Gearbox
18. Stem Construction	outside screw stem
19. Bonnet Construction	bolted bonnet
20. Product testing	FAT according A.9.3
21. Coating or Cladding	N/A
22. Notes	N/A
23. Additional Requirements	N/A

Valve Code	VGL-300-2-C2F1
Specs	C6
1. Valve Type	Globe
2. Sealing Type	Metal to Metal
3. Valve Specification Level (VSL)	VSL-2
4. Obturator Type	Bevelled Disc
5. Standard	API 623
6. Size Range (NPS)	2" - 18"
7. End Connection	ASME B16.5, RF
8. Pressure Class	300
9. Temperature	-46°C to 345°C
10. Material Class	Low-Temperature Carbon Steel
11. Body Material	ASTM A350 Gr LF2 CL1 or ASTM A352 Gr LCC
12. TRIM Material	N/A
13. Obturator Material	AISI 316
14. Seat Material	Stellite (Co-Cr Alloy acc. item A.8.2.1.2)
15. Stem Material	ASTM A564 Type 630 H1150 (UNS S17400)
16. Seat-Stem Seal Material	Flexible graphite with inconel wire
17. Operator Type	2" - 6" Rising Handwheel 8" - 18" Gearbox
18. Stem Construction	outside screw stem
19. Bonnet Construction	bolted bonnet
20. Product testing	FAT according A.9.3
21. Coating or Cladding	N/A
22. Notes	N/A
23. Additional Requirements	Fugitive Emission (acc. item A.6.1.6)

Valve Code	VGL-300-2-C501
Specs	C30
1. Valve Type	Globe
2. Sealing Type	Metal to Metal
3. Valve Specification Level (VSL)	VSL-2
4. Obturator Type	Bevelled Disc
5. Standard	API 623
6. Size Range (NPS)	2" - 20"
7. End Connection	ASME B16.5, RF
8. Pressure Class	300
9. Temperature	-29°C to 400°C
10. Material Class	Carbon Steel with Cladding
11. Body Material	ASTM A105 or ASTM A216 Gr WCB + Inconel 625 weld overlay (acc. item A.7.1.7.3)
12. TRIM Material	N/A
13. Obturator Material	ASTM A105 + Inconel 625 weld overlay (acc. item A.7.1.7.3)
14. Seat Material	ASTM A105 + Inconel 625 weld overlay (acc. item A.7.1.7.3)
15. Stem Material	ASTM B637 (UNS N07718)
16. Seat-Stem Seal Material	Flexible graphite with inconel wire
17. Operator Type	2" - 6" Rising Handwheel 8" - 20" Gearbox
18. Stem Construction	outside screw stem
19. Bonnet Construction	bolted bonnet
20. Product testing	FAT according A.9.3
21. Coating or Cladding	Full clad - Inconel 625 weld overlay on all wetted parts
22. Notes	N/A
23. Additional Requirements	N/A

Valve Code	VGL-300-2-C5F1
Specs	C30
1. Valve Type	Globe
2. Sealing Type	Metal to Metal
3. Valve Specification Level (VSL)	VSL-2
4. Obturator Type	Bevelled Disc
5. Standard	API 623
6. Size Range (NPS)	2" - 18"
7. End Connection	ASME B16.5, RF
8. Pressure Class	300
9. Temperature	-29°C to 400°C
10. Material Class	Carbon Steel with Cladding
11. Body Material	ASTM A105 or ASTM A216 Gr WCB + Inconel 625 weld overlay (acc. item A.7.1.7.3)
12. TRIM Material	N/A
13. Obturator Material	ASTM A105 + Inconel 625 weld overlay (acc. item A.7.1.7.3)
14. Seat Material	ASTM A105 + Inconel 625 weld overlay (acc. item A.7.1.7.3)
15. Stem Material	ASTM B637 (UNS N07718)
16. Seat-Stem Seal Material	Flexible graphite with inconel wire
17. Operator Type	2" - 6" Rising Handwheel 8" - 18" Gearbox
18. Stem Construction	outside screw stem
19. Bonnet Construction	bolted bonnet
20. Product testing	FAT according A.9.3
21. Coating or Cladding	Full clad - Inconel 625 weld overlay on all wetted parts
22. Notes	N/A
23. Additional Requirements	Fugitive Emission (acc. item A.6.1.6)

Valve Code	VGL-300-2-D101
Specs	C11
1. Valve Type	Globe
2. Sealing Type	Metal to Metal
3. Valve Specification Level (VSL)	VSL-2
4. Obturator Type	Bevelled Disc
5. Standard	API 623
6. Size Range (NPS)	2" - 18"
7. End Connection	ASME B16.5, RF
8. Pressure Class	300
9. Temperature	0°C to 150°C
10. Material Class	Duplex Steel
11. Body Material	ASTM A995 Gr 1b
12. TRIM Material	N/A
13. Obturator Material	Duplex (UNS S32550)
14. Seat Material	Duplex (UNS S32550)
15. Stem Material	ASTM A276 (UNS S32550)
16. Seat-Stem Seal Material	Flexible graphite with inconel wire
17. Operator Type	2" - 6" Rising Handwheel 8" - 18" Gearbox
18. Stem Construction	outside screw stem
19. Bonnet Construction	bolted bonnet
20. Product testing	FAT according A.9.3
21. Coating or Cladding	N/A
22. Notes	N/A
23. Additional Requirements	N/A



Valve Code	VGL-300-2-D201
Specs	C11 C16
1. Valve Type	Globe
2. Sealing Type	Metal to Metal
3. Valve Specification Level (VSL)	VSL-2
4. Obturator Type	Bevelled Disc
5. Standard	API 623
6. Size Range (NPS)	2" - 18"
7. End Connection	ASME B16.5, RF
8. Pressure Class	300
9. Temperature	-46°C to 150°C
10. Material Class	Duplex Steel
11. Body Material	ASTM A182 Gr F51 or ASTM A995 Gr 4A
12. TRIM Material	N/A
13. Obturator Material	Duplex (UNS S31803)
14. Seat Material	Duplex (UNS S31803)
15. Stem Material	ASTM A276 (UNS S31803)
16. Seat-Stem Seal Material	Flexible graphite with inconel wire
17. Operator Type	2" - 6" Rising Handwheel 8" - 18" Gearbox
18. Stem Construction	outside screw stem
19. Bonnet Construction	bolted bonnet
20. Product testing	FAT according A.9.3
21. Coating or Cladding	N/A
22. Notes	N/A
23. Additional Requirements	N/A

Valve Code	VGL-300-2-D2F1
Specs	C16
1. Valve Type	Globe
2. Sealing Type	Metal to Metal
3. Valve Specification Level (VSL)	VSL-2
4. Obturator Type	Bevelled Disc
5. Standard	API 623
6. Size Range (NPS)	2" - 18"
7. End Connection	ASME B16.5, RF
8. Pressure Class	300
9. Temperature	-46°C to 150°C
10. Material Class	Duplex Steel
11. Body Material	ASTM A182 Gr F51 or ASTM A995 Gr 4A
12. TRIM Material	N/A
13. Obturator Material	Duplex (UNS S31803)
14. Seat Material	Duplex (UNS S31803)
15. Stem Material	ASTM A276 (UNS S31803)
16. Seat-Stem Seal Material	Flexible graphite with inconel wire
17. Operator Type	2" - 6" Rising Handwheel 8" - 18" Gearbox
18. Stem Construction	outside screw stem
19. Bonnet Construction	bolted bonnet
20. Product testing	FAT according A.9.3
21. Coating or Cladding	N/A
22. Notes	N/A
23. Additional Requirements	Fugitive Emission (acc. item A.6.1.6)

Valve Code	VGL-300-2-S201
Specs	C3
1. Valve Type	Globe
2. Sealing Type	Metal to Metal
3. Valve Specification Level (VSL)	VSL-2
4. Obturator Type	Bevelled Disc
5. Standard	API 623
6. Size Range (NPS)	2" - 18"
7. End Connection	ASME B16.5, RF
8. Pressure Class	300
9. Temperature	-100°C to 400°C
10. Material Class	Stainless Steel
11. Body Material	ASTM A182 Gr F316 or ASTM A351 Gr CF8M
12. TRIM Material	N/A
13. Obturator Material	AISI 316
14. Seat Material	Stellite (Co-Cr Alloy acc. item A.8.2.1.2)
15. Stem Material	ASTM A276 (UNS S31600)
16. Seat-Stem Seal Material	Flexible graphite with inconel wire
17. Operator Type	2" - 6" Rising Handwheel 8" - 18" Gearbox
18. Stem Construction	outside screw stem
19. Bonnet Construction	bolted bonnet
20. Product testing	FAT according A.9.3
21. Coating or Cladding	N/A
22. Notes	N/A
23. Additional Requirements	N/A

Valve Code	VGL-300-2-S2F1
Specs	C3
1. Valve Type	Globe
2. Sealing Type	Metal to Metal
3. Valve Specification Level (VSL)	VSL-2
4. Obturator Type	Bevelled Disc
5. Standard	API 623
6. Size Range (NPS)	2" - 18"
7. End Connection	ASME B16.5, RF
8. Pressure Class	300
9. Temperature	-46°C to 400°C
10. Material Class	Stainless Steel
11. Body Material	ASTM A182 Gr F316 or ASTM A351 Gr CF8M
12. TRIM Material	N/A
13. Obturator Material	AISI 316
14. Seat Material	Stellite (Co-Cr Alloy acc. item A.8.2.1.2)
15. Stem Material	ASTM A276 (UNS S31600)
16. Seat-Stem Seal Material	Flexible graphite with inconel wire
17. Operator Type	2" - 6" Rising Handwheel 8" - 18" Gearbox
18. Stem Construction	outside screw stem
19. Bonnet Construction	bolted bonnet
20. Product testing	FAT according A.9.3
21. Coating or Cladding	N/A
22. Notes	N/A
23. Additional Requirements	Fugitive Emission (acc. item A.6.1.6)

Valve Code	VGL-600-1-C101
Specs	E34
1. Valve Type	Globe
2. Sealing Type	Metal to Metal
3. Valve Specification Level (VSL)	VSL-1
4. Obturator Type	Bevelled Disc
5. Standard	API 623
6. Size Range (NPS)	2" - 4"
7. End Connection	ASME B16.5, RF
8. Pressure Class	600
9. Temperature	-29°C to 400°C
10. Material Class	Carbon Steel
11. Body Material	ASTM A105 or ASTM A216 Gr WCB
12. TRIM Material	TRIM CR 13 and HF according BS 1873
13. Obturator Material	AISI 410
14. Seat Material	Stellite (Co-Cr Alloy acc. item A.8.2.1.2)
15. Stem Material	ASTM A276 (UNS S41000)
16. Seat-Stem Seal Material	Flexible graphite with inconel wire
17. Operator Type	2" - 3" Rising Handwheel 4" Gearbox
18. Stem Construction	outside screw stem
19. Bonnet Construction	bolted bonnet
20. Product testing	FAT according A.9.3
21. Coating or Cladding	N/A
22. Notes	N/A
23. Additional Requirements	N/A

Valve Code	VGL-600-1-C201
Specs	E6 E19
1. Valve Type	Globe
2. Sealing Type	Metal to Metal
3. Valve Specification Level (VSL)	VSL-1
4. Obturator Type	Bevelled Disc
5. Standard	API 623
6. Size Range (NPS)	2" - 20"
7. End Connection	ASME B16.5, RF
8. Pressure Class	600
9. Temperature	-46°C to 345°C
10. Material Class	Low-Temperature Carbon Steel
11. Body Material	ASTM A350 Gr LF2 CL1 or ASTM A352 Gr LCC
12. TRIM Material	N/A
13. Obturator Material	AISI 316
14. Seat Material	Stellite (Co-Cr Alloy acc. item A.8.2.1.2)
15. Stem Material	ASTM A564 Type 630 H1150 (UNS S17400)
16. Seat-Stem Seal Material	Flexible graphite with inconel wire
17. Operator Type	2" - 3" Rising Handwheel 4" - 20" Gearbox
18. Stem Construction	outside screw stem
19. Bonnet Construction	bolted bonnet
20. Product testing	FAT according A.9.3
21. Coating or Cladding	N/A
22. Notes	N/A
23. Additional Requirements	N/A

Valve Code	VGL-600-1-D201
Specs	E16
1. Valve Type	Globe
2. Sealing Type	Metal to Metal
3. Valve Specification Level (VSL)	VSL-1
4. Obturator Type	Bevelled Disc
5. Standard	API 623
6. Size Range (NPS)	2" - 4"
7. End Connection	ASME B16.5, RF
8. Pressure Class	600
9. Temperature	-46°C to 150°C
10. Material Class	Duplex Steel
11. Body Material	ASTM A182 Gr F51 or ASTM A995 Gr 4A
12. TRIM Material	N/A
13. Obturator Material	Duplex (UNS S31803)
14. Seat Material	Duplex (UNS S31803)
15. Stem Material	ASTM A276 (UNS S31803)
16. Seat-Stem Seal Material	Flexible graphite with inconel wire
17. Operator Type	2" - 3" Rising Handwheel 4" Gearbox
18. Stem Construction	outside screw stem
19. Bonnet Construction	bolted bonnet
20. Product testing	FAT according A.9.3
21. Coating or Cladding	N/A
22. Notes	N/A
23. Additional Requirements	N/A

Valve Code	VGL-600-1-S201
Specs	E3
1. Valve Type	Globe
2. Sealing Type	Metal to Metal
3. Valve Specification Level (VSL)	VSL-1
4. Obturator Type	Bevelled Disc
5. Standard	API 623
6. Size Range (NPS)	2" - 4"
7. End Connection	ASME B16.5, RF
8. Pressure Class	600
9. Temperature	-100°C to 400°C
10. Material Class	Stainless Steel
11. Body Material	ASTM A182 Gr F316 or ASTM A351 Gr CF8M
12. TRIM Material	316 and Hardfaced
13. Obturator Material	AISI 316
14. Seat Material	Stellite (Co-Cr Alloy acc. item A.8.2.1.2)
15. Stem Material	ASTM A276 (UNS S31600)
16. Seat-Stem Seal Material	Flexible graphite with inconel wire
17. Operator Type	2" - 3" Rising Handwheel 4" Gearbox
18. Stem Construction	outside screw stem
19. Bonnet Construction	bolted bonnet
20. Product testing	FAT according A.9.3
21. Coating or Cladding	N/A
22. Notes	N/A
23. Additional Requirements	N/A

Valve Code	VGL-600-2-C101
Specs	E34
1. Valve Type	Globe
2. Sealing Type	Metal to Metal
3. Valve Specification Level (VSL)	VSL-2
4. Obturator Type	Bevelled Disc
5. Standard	API 623
6. Size Range (NPS)	2" - 12"
7. End Connection	ASME B16.5, RF
8. Pressure Class	600
9. Temperature	-29°C to 400°C
10. Material Class	Carbon Steel
11. Body Material	ASTM A105 or ASTM A216 Gr WCB
12. TRIM Material	TRIM CR 13 and HF according BS 1873
13. Obturator Material	AISI 410
14. Seat Material	Stellite (Co-Cr Alloy acc. item A.8.2.1.2)
15. Stem Material	ASTM A276 (UNS S41000)
16. Seat-Stem Seal Material	Flexible graphite with inconel wire
17. Operator Type	2" - 3" Rising Handwheel 4" - 12" Gearbox
18. Stem Construction	outside screw stem
19. Bonnet Construction	bolted bonnet
20. Product testing	FAT according A.9.3
21. Coating or Cladding	N/A
22. Notes	N/A
23. Additional Requirements	N/A

Valve Code	VGL-600-2-C1F1
Specs	E34
1. Valve Type	Globe
2. Sealing Type	Metal to Metal
3. Valve Specification Level (VSL)	VSL-2
4. Obturator Type	Bevelled Disc
5. Standard	API 623
6. Size Range (NPS)	2" - 12"
7. End Connection	ASME B16.5, RF
8. Pressure Class	600
9. Temperature	-29°C to 400°C
10. Material Class	Carbon Steel
11. Body Material	ASTM A105 or ASTM A216 Gr WCB
12. TRIM Material	TRIM CR 13 and HF according BS 1873
13. Obturator Material	AISI 410
14. Seat Material	Stellite (Co-Cr Alloy acc. item A.8.2.1.2)
15. Stem Material	ASTM A276 (UNS S41000)
16. Seat-Stem Seal Material	Flexible graphite with inconel wire
17. Operator Type	2" - 3" Rising Handwheel 4" - 12" Gearbox
18. Stem Construction	outside screw stem
19. Bonnet Construction	bolted bonnet
20. Product testing	FAT according A.9.3
21. Coating or Cladding	N/A
22. Notes	N/A
23. Additional Requirements	Fugitive Emission (acc. item A.6.1.6)

Valve Code	VGL-600-2-C1F2
Specs	E34
1. Valve Type	Globe
2. Sealing Type	Metal to Metal
3. Valve Specification Level (VSL)	VSL-2
4. Obturator Type	Bevelled Disc
5. Standard	API 623
6. Size Range (NPS)	2" - 12"
7. End Connection	ASME B16.5, RF
8. Pressure Class	600
9. Temperature	-29°C to 400°C
10. Material Class	Carbon Steel
11. Body Material	ASTM A105 or ASTM A216 Gr WCB
12. TRIM Material	TRIM HF according BS 1873
13. Obturator Material	Stellite (Co-Cr Alloy acc. item A.8.2.1.2)
14. Seat Material	Stellite (Co-Cr Alloy acc. item A.8.2.1.2)
15. Stem Material	ASTM A276 (UNS S41000)
16. Seat-Stem Seal Material	Flexible graphite with inconel wire
17. Operator Type	2" - 3" Rising Handwheel 4" - 12" Gearbox
18. Stem Construction	outside screw stem
19. Bonnet Construction	bolted bonnet
20. Product testing	FAT according A.9.3
21. Coating or Cladding	N/A
22. Notes	N/A
23. Additional Requirements	Fugitive Emission (acc. item A.6.1.6)

Valve Code	VGL-600-2-C201
Specs	E6 E19
1. Valve Type	Globe
2. Sealing Type	Metal to Metal
3. Valve Specification Level (VSL)	VSL-2
4. Obturator Type	Bevelled Disc
5. Standard	API 623
6. Size Range (NPS)	2" - 20"
7. End Connection	ASME B16.5, RF
8. Pressure Class	600
9. Temperature	-46°C to 345°C
10. Material Class	Low-Temperature Carbon Steel
11. Body Material	ASTM A350 Gr LF2 CL1 or ASTM A352 Gr LCC
12. TRIM Material	N/A
13. Obturator Material	AISI 316
14. Seat Material	Stellite (Co-Cr Alloy acc. item A.8.2.1.2)
15. Stem Material	ASTM A564 Type 630 H1150 (UNS S17400)
16. Seat-Stem Seal Material	Flexible graphite with inconel wire
17. Operator Type	2" - 3" Rising Handwheel 4" - 20" Gearbox
18. Stem Construction	outside screw stem
19. Bonnet Construction	bolted bonnet
20. Product testing	FAT according A.9.3
21. Coating or Cladding	N/A
22. Notes	N/A
23. Additional Requirements	N/A

Valve Code	VGL-600-2-C2F1
Specs	E6 E19
1. Valve Type	Globe
2. Sealing Type	Metal to Metal
3. Valve Specification Level (VSL)	VSL-2
4. Obturator Type	Bevelled Disc
5. Standard	API 623
6. Size Range (NPS)	2" - 20"
7. End Connection	ASME B16.5, RF
8. Pressure Class	600
9. Temperature	-46°C to 345°C
10. Material Class	Low-Temperature Carbon Steel
11. Body Material	ASTM A350 Gr LF2 CL1 or ASTM A352 Gr LCC
12. TRIM Material	N/A
13. Obturator Material	AISI 316
14. Seat Material	Stellite (Co-Cr Alloy acc. item A.8.2.1.2)
15. Stem Material	ASTM A564 Type 630 H1150 (UNS S17400)
16. Seat-Stem Seal Material	Flexible graphite with inconel wire
17. Operator Type	2" - 3" Rising Handwheel 4" - 20" Gearbox
18. Stem Construction	outside screw stem
19. Bonnet Construction	bolted bonnet
20. Product testing	FAT according A.9.3
21. Coating or Cladding	N/A
22. Notes	N/A
23. Additional Requirements	Fugitive Emission (acc. item A.6.1.6)

Valve Code	VGL-600-2-C501
Specs	E30
1. Valve Type	Globe
2. Sealing Type	Metal to Metal
3. Valve Specification Level (VSL)	VSL-2
4. Obturator Type	Bevelled Disc
5. Standard	API 623
6. Size Range (NPS)	2" - 12"
7. End Connection	ASME B16.5, RF
8. Pressure Class	600
9. Temperature	-29°C to 400°C
10. Material Class	Carbon Steel with Cladding
11. Body Material	ASTM A105 or ASTM A216 Gr WCB + Inconel 625 weld overlay (acc. item A.7.1.7.3)
12. TRIM Material	N/A
13. Obturator Material	ASTM A105 + Inconel 625 weld overlay (acc. item A.7.1.7.3)
14. Seat Material	ASTM A105 + Inconel 625 weld overlay (acc. item A.7.1.7.3)
15. Stem Material	ASTM B637 (UNS N07718)
16. Seat-Stem Seal Material	Flexible graphite with inconel wire
17. Operator Type	2" - 3" Rising Handwheel 4" - 12" Gearbox
18. Stem Construction	outside screw stem
19. Bonnet Construction	bolted bonnet
20. Product testing	FAT according A.9.3
21. Coating or Cladding	Full clad - Inconel 625 weld overlay on all wetted parts
22. Notes	N/A
23. Additional Requirements	N/A

Valve Code	VGL-600-2-C5F1
Specs	E30
1. Valve Type	Globe
2. Sealing Type	Metal to Metal
3. Valve Specification Level (VSL)	VSL-2
4. Obturator Type	Bevelled Disc
5. Standard	API 623
6. Size Range (NPS)	2" - 12"
7. End Connection	ASME B16.5, RF
8. Pressure Class	600
9. Temperature	-29°C to 400°C
10. Material Class	Carbon Steel with Cladding
11. Body Material	ASTM A105 or ASTM A216 Gr WCB + Inconel 625 weld overlay (acc. item A.7.1.7.3)
12. TRIM Material	N/A
13. Obturator Material	ASTM A105 + Inconel 625 weld overlay (acc. item A.7.1.7.3)
14. Seat Material	ASTM A105 + Inconel 625 weld overlay (acc. item A.7.1.7.3)
15. Stem Material	ASTM B637 (UNS N07718)
16. Seat-Stem Seal Material	Flexible graphite with inconel wire
17. Operator Type	2" - 3" Rising Handwheel 4" - 12" Gearbox
18. Stem Construction	outside screw stem
19. Bonnet Construction	bolted bonnet
20. Product testing	FAT according A.9.3
21. Coating or Cladding	Full clad - Inconel 625 weld overlay on all wetted parts
22. Notes	N/A
23. Additional Requirements	Fugitive Emission (acc. item A.6.1.6)

Valve Code	VGL-600-2-D201
Specs	E16
1. Valve Type	Globe
2. Sealing Type	Metal to Metal
3. Valve Specification Level (VSL)	VSL-2
4. Obturator Type	Bevelled Disc
5. Standard	API 623
6. Size Range (NPS)	2" - 12"
7. End Connection	ASME B16.5, RF
8. Pressure Class	600
9. Temperature	-46°C to 150°C
10. Material Class	Duplex Steel
11. Body Material	ASTM A182 Gr F51 or ASTM A995 Gr 4A
12. TRIM Material	N/A
13. Obturator Material	Duplex (UNS S31803)
14. Seat Material	Duplex (UNS S31803)
15. Stem Material	ASTM A276 (UNS S31803)
16. Seat-Stem Seal Material	Flexible graphite with inconel wire
17. Operator Type	2" - 3" Rising Handwheel 4" - 12" Gearbox
18. Stem Construction	outside screw stem
19. Bonnet Construction	bolted bonnet
20. Product testing	FAT according A.9.3
21. Coating or Cladding	N/A
22. Notes	N/A
23. Additional Requirements	N/A

Valve Code	VGL-600-2-D2F1
Specs	E16
1. Valve Type	Globe
2. Sealing Type	Metal to Metal
3. Valve Specification Level (VSL)	VSL-2
4. Obturator Type	Bevelled Disc
5. Standard	API 623
6. Size Range (NPS)	2" - 12"
7. End Connection	ASME B16.5, RF
8. Pressure Class	600
9. Temperature	-46°C to 150°C
10. Material Class	Duplex Steel
11. Body Material	ASTM A182 Gr F51 or ASTM A995 Gr 4A
12. TRIM Material	N/A
13. Obturator Material	Duplex (UNS S31803)
14. Seat Material	Duplex (UNS S31803)
15. Stem Material	ASTM A276 (UNS S31803)
16. Seat-Stem Seal Material	Flexible graphite with inconel wire
17. Operator Type	2" - 3" Rising Handwheel 4" - 12" Gearbox
18. Stem Construction	outside screw stem
19. Bonnet Construction	bolted bonnet
20. Product testing	FAT according A.9.3
21. Coating or Cladding	N/A
22. Notes	N/A
23. Additional Requirements	Fugitive Emission (acc. item A.6.1.6)

Valve Code	VGL-600-2-S201
Specs	E3
1. Valve Type	Globe
2. Sealing Type	Metal to Metal
3. Valve Specification Level (VSL)	VSL-2
4. Obturator Type	Bevelled Disc
5. Standard	API 623
6. Size Range (NPS)	2" - 18"
7. End Connection	ASME B16.5, RF
8. Pressure Class	600
9. Temperature	-100°C to 400°C
10. Material Class	Stainless Steel
11. Body Material	ASTM A182 Gr F316 or ASTM A351 Gr CF8M
12. TRIM Material	316 and Hardfaced
13. Obturator Material	AISI 316
14. Seat Material	Stellite (Co-Cr Alloy acc. item A.8.2.1.2)
15. Stem Material	ASTM A276 (UNS S31600)
16. Seat-Stem Seal Material	Flexible graphite with inconel wire
17. Operator Type	2" - 3" Rising Handwheel 4" - 18" Gearbox
18. Stem Construction	outside screw stem
19. Bonnet Construction	bolted bonnet
20. Product testing	FAT according A.9.3
21. Coating or Cladding	N/A
22. Notes	N/A
23. Additional Requirements	N/A

Valve Code	VGL-600-2-S2F1
Specs	E3
1. Valve Type	Globe
2. Sealing Type	Metal to Metal
3. Valve Specification Level (VSL)	VSL-2
4. Obturator Type	Bevelled Disc
5. Standard	API 623
6. Size Range (NPS)	2" - 18"
7. End Connection	ASME B16.5, RF
8. Pressure Class	600
9. Temperature	-100°C to 400°C
10. Material Class	Stainless Steel
11. Body Material	ASTM A182 Gr F316 or ASTM A351 Gr CF8M
12. TRIM Material	316 and Hardfaced
13. Obturator Material	AISI 316
14. Seat Material	Stellite (Co-Cr Alloy acc. item A.8.2.1.2)
15. Stem Material	ASTM A276 (UNS S31600)
16. Seat-Stem Seal Material	Flexible graphite with inconel wire
17. Operator Type	2" - 3" Rising Handwheel 4" - 18" Gearbox
18. Stem Construction	outside screw stem
19. Bonnet Construction	bolted bonnet
20. Product testing	FAT according A.9.3
21. Coating or Cladding	N/A
22. Notes	N/A
23. Additional Requirements	Fugitive Emission (acc. item A.6.1.6)

Valve Code	VGL-900-2-C201
Specs	F6
1. Valve Type	Globe
2. Sealing Type	Metal to Metal
3. Valve Specification Level (VSL)	VSL-2
4. Obturator Type	Bevelled Disc
5. Standard	API 623
6. Size Range (NPS)	2" - 14"
7. End Connection	ASME B16.5, RTJ
8. Pressure Class	900
9. Temperature	-46°C to 345°C
10. Material Class	Low-Temperature Carbon Steel
11. Body Material	ASTM A350 Gr LF2 CL1 or ASTM A352 Gr LCC
12. TRIM Material	N/A
13. Obturator Material	AISI 316
14. Seat Material	Stellite (Co-Cr Alloy acc. item A.8.2.1.2)
15. Stem Material	ASTM A564 Type 630 H1150 (UNS S17400)
16. Seat-Stem Seal Material	Flexible graphite with inconel wire
17. Operator Type	2" - 3" Rising Handwheel 4" - 14" Gearbox
18. Stem Construction	outside screw stem
19. Bonnet Construction	bolted bonnet
20. Product testing	FAT according A.9.3
21. Coating or Cladding	N/A
22. Notes	N/A
23. Additional Requirements	N/A

Valve Code	VGL-900-2-C2F1
Specs	F6
1. Valve Type	Globe
2. Sealing Type	Metal to Metal
3. Valve Specification Level (VSL)	VSL-2
4. Obturator Type	Bevelled Disc
5. Standard	API 623
6. Size Range (NPS)	2" - 14"
7. End Connection	ASME B16.5, RTJ
8. Pressure Class	900
9. Temperature	-46°C to 345°C
10. Material Class	Low-Temperature Carbon Steel
11. Body Material	ASTM A350 Gr LF2 CL1 or ASTM A352 Gr LCC
12. TRIM Material	N/A
13. Obturator Material	AISI 316
14. Seat Material	Stellite (Co-Cr Alloy acc. item A.8.2.1.2)
15. Stem Material	ASTM A564 Type 630 H1150 (UNS S17400)
16. Seat-Stem Seal Material	Flexible graphite with inconel wire
17. Operator Type	2" - 3" Rising Handwheel 4" - 14" Gearbox
18. Stem Construction	outside screw stem
19. Bonnet Construction	bolted bonnet
20. Product testing	FAT according A.9.3
21. Coating or Cladding	N/A
22. Notes	N/A
23. Additional Requirements	Fugitive Emission (acc. item A.6.1.6)

A.12.5 CHECK VALVES

Valve Code	VRE-1500-1-C102
Specs	G10
1. Valve Type	Check
2. Sealing Type	Metal to Metal
3. Valve Specification Level (VSL)	VSL-1
4. Obturator Type	Piston
5. Standard	API 602
6. Size Range (NPS)	½" - 1 ½"
7. End Connection	socket weld ends ASME B16.11
8. Pressure Class	1500
9. Temperature	-29°C to 400°C
10. Material Class	Carbon Steel
11. Body Material	ASTM A105
12. TRIM Material	TRIM 8 according API 594
13. Obturator Material	AISI 410
14. Seat Material	Stellite (Co-Cr Alloy acc. item A.8.2.1.2)
15. Spring Material	N/A
16. Shaft Material	Not Applicable
17. Operator Type	N/A
18. Additional Requirement	Fire safe design (acc. item A.6.1.5)
19. Cover Construction	bolted cover
20. Product testing	FAT according A.9.3
21. Notes	N/A

Valve Code	VRE-1500-1-C202
Specs	F6
1. Valve Type	Check
2. Sealing Type	Metal to Metal
3. Valve Specification Level (VSL)	VSL-1
4. Obturator Type	Piston
5. Standard	API 602
6. Size Range (NPS)	½" - 1 ½"
7. End Connection	socket weld ends ASME B16.11
8. Pressure Class	1500
9. Temperature	-46°C to 345°C
10. Material Class	Low-Temperature Carbon Steel
11. Body Material	ASTM A350 Gr LF2 CL1
12. TRIM Material	TRIM 12 according API 594
13. Obturator Material	AISI 316
14. Seat Material	Stellite (Co-Cr Alloy acc. item A.8.2.1.2)
15. Spring Material	N/A
16. Shaft Material	Not Applicable
17. Operator Type	N/A
18. Additional Requirement	Fire safe design (acc. item A.6.1.5)
19. Cover Construction	bolted cover
20. Product testing	FAT according A.9.3
21. Notes	N/A

Valve Code	VRE-1500-1-D202
Specs	G16P G16
1. Valve Type	Check
2. Sealing Type	Metal to Metal
3. Valve Specification Level (VSL)	VSL-1
4. Obturator Type	Piston
5. Standard	API 602
6. Size Range (NPS)	½" - 1 ½"
7. End Connection	socket weld ends ASME B16.11
8. Pressure Class	1500
9. Temperature	-46°C to 150°C
10. Material Class	Duplex Steel
11. Body Material	ASTM A182 Gr F51
12. TRIM Material	N/A
13. Obturator Material	Duplex (UNS S31803)
14. Seat Material	Duplex (UNS S31803)
15. Spring Material	N/A
16. Shaft Material	Not Applicable
17. Operator Type	N/A
18. Additional Requirement	Fire safe design (acc. item A.6.1.5)
19. Cover Construction	bolted cover
20. Product testing	FAT according A.9.3
21. Notes	N/A

Valve Code	VRE-1500-1-S202
Specs	G3
1. Valve Type	Check
2. Sealing Type	Metal to Metal
3. Valve Specification Level (VSL)	VSL-1
4. Obturator Type	Piston
5. Standard	API 602
6. Size Range (NPS)	½" - 1 ½"
7. End Connection	socket weld ends ASME B16.11
8. Pressure Class	1500
9. Temperature	-100°C to 400°C
10. Material Class	Stainless Steel
11. Body Material	ASTM A182 Gr F316/316L
12. TRIM Material	N/A
13. Obturator Material	AISI 316L
14. Seat Material	Stellite (Co-Cr Alloy acc. item A.8.2.1.2)
15. Spring Material	N/A
16. Shaft Material	Not Applicable
17. Operator Type	N/A
18. Additional Requirement	Fire safe design (acc. item A.6.1.5)
19. Cover Construction	bolted cover
20. Product testing	FAT according A.9.3
21. Notes	N/A

Valve Code	VRE-1500-2-C112
Specs	G10
1. Valve Type	Check, Wafer type
2. Sealing Type	Metal to Metal
3. Valve Specification Level (VSL)	VSL-2
4. Obturator Type	Dual Plate
5. Standard	API 594
6. Size Range (NPS)	2" - 24"
7. End Connection	RTJ
8. Pressure Class	1500
9. Temperature	-29°C to 400°C
10. Material Class	Carbon Steel
11. Body Material	ASTM A105
12. TRIM Material	TRIM 8 according API 594
13. Obturator Material	AISI 410
14. Seat Material	Stellite (Co-Cr Alloy acc. item A.8.2.1.2)
15. Spring Material	UNS N07750
16. Shaft Material	ASTM A276 (UNS S41000)
17. Additional Requirement	Fire safe design (acc. item A.6.1.5)
18. Cover Construction	Not Applicable
19. Product testing	FAT according A.9.3
20. Cladding or Coating	N/A
21. Notes	wafer valves shall not to be used with flammable services.

Valve Code	VRE-1500-2-C115
Specs	G10
1. Valve Type	Check, Flanged type
2. Sealing Type	Metal to Metal
3. Valve Specification Level (VSL)	VSL-2
4. Obturator Type	Dual Plate
5. Standard	API 594
6. Size Range (NPS)	2" - 24"
7. End Connection	RTJ
8. Pressure Class	1500
9. Temperature	-29°C to 400°C
10. Material Class	Carbon Steel
11. Body Material	ASTM A105
12. TRIM Material	TRIM 8 according API 594
13. Obturator Material	AISI 410
14. Seat Material	Stellite (Co-Cr Alloy acc. item A.8.2.1.2)
15. Spring Material	UNS N07750
16. Shaft Material	ASTM A276 (UNS S41000)
17. Additional Requirement	Fire safe design (acc. item A.6.1.5)
18. Cover Construction	Not Applicable
19. Product testing	FAT according A.9.3
20. Cladding or Coating	N/A
21. Notes	N/A

Valve Code	VRE-1500-2-C135
Specs	G10
1. Valve Type	Check, Flanged type
2. Sealing Type	Metal to Metal
3. Valve Specification Level (VSL)	VSL-2
4. Obturator Type	Axial non-slam
5. Standard	API 6D
6. Size Range (NPS)	2" - 12"
7. End Connection	RTJ
8. Pressure Class	1500
9. Temperature	-29°C to 210°C
10. Material Class	Carbon Steel
11. Body Material	ASTM A105
12. TRIM Material	N/A
13. Obturator Material	AISI 410
14. Seat Material	AISI 410
15. Spring Material	UNS N07750
16. Shaft Material	Not Applicable
17. Additional Requirement	Fire safe design (acc. item A.6.1.5)
18. Cover Construction	Not Applicable
19. Product testing	FAT according A.9.3
20. Cladding or Coating	N/A
21. Notes	N/A

Valve Code	VRE-1500-2-D212
Specs	G16P G16
1. Valve Type	Check, Wafer type
2. Sealing Type	Metal to Metal
3. Valve Specification Level (VSL)	VSL-2
4. Obturator Type	Dual Plate
5. Standard	API 594
6. Size Range (NPS)	2" - 24"
7. End Connection	RTJ
8. Pressure Class	1500
9. Temperature	-46°C to 150°C
10. Material Class	Duplex Steel
11. Body Material	ASTM A182 Gr F51
12. TRIM Material	N/A
13. Obturator Material	Duplex (UNS S31803)
14. Seat Material	Duplex (UNS S31803)
15. Spring Material	UNS N06625
16. Shaft Material	ASTM A276 (UNS S31803)
17. Additional Requirement	Fire safe design (acc. item A.6.1.5)
18. Cover Construction	Not Applicable
19. Product testing	FAT according A.9.3
20. Cladding or Coating	N/A
21. Notes	wafer valves shall not to be used with flammable services.

Valve Code	VRE-1500-2-D215
Specs	G16P G16
1. Valve Type	Check, Flanged type
2. Sealing Type	Metal to Metal
3. Valve Specification Level (VSL)	VSL-2
4. Obturator Type	Dual Plate
5. Standard	API 594
6. Size Range (NPS)	2" - 24"
7. End Connection	RTJ
8. Pressure Class	1500
9. Temperature	-46°C to 150°C
10. Material Class	Duplex Steel
11. Body Material	ASTM A182 Gr F51
12. TRIM Material	N/A
13. Obturator Material	Duplex (UNS S31803)
14. Seat Material	Duplex (UNS S31803)
15. Spring Material	UNS N06625
16. Shaft Material	ASTM A276 (UNS S31803)
17. Additional Requirement	Fire safe design (acc. item A.6.1.5)
18. Cover Construction	Not Applicable
19. Product testing	FAT according A.9.3
20. Cladding or Coating	N/A
21. Notes	N/A

Valve Code	VRE-1500-2-S202
Specs	G3
1. Valve Type	Check
2. Sealing Type	Metal to Metal
3. Valve Specification Level (VSL)	VSL-2
4. Obturator Type	Piston
5. Standard	API 602
6. Size Range (NPS)	½" - 1 ½"
7. End Connection	socket weld ends ASME B16.11
8. Pressure Class	1500
9. Temperature	-100°C to 400°C
10. Material Class	Stainless Steel
11. Body Material	ASTM A182 Gr F316/316L
12. TRIM Material	N/A
13. Obturator Material	AISI 316L
14. Seat Material	Stellite (Co-Cr Alloy acc. item A.8.2.1.2)
15. Spring Material	N/A
16. Shaft Material	Not Applicable
17. Operator Type	N/A
18. Additional Requirement	Fire safe design (acc. item A.6.1.5)
19. Cover Construction	bolted cover
20. Product testing	FAT according A.9.3
21. Notes	N/A

Valve Code	VRE-1500-2-S212
Specs	G3
1. Valve Type	Check, Wafer type
2. Sealing Type	Metal to Metal
3. Valve Specification Level (VSL)	VSL-2
4. Obturator Type	Dual Plate
5. Standard	API 594
6. Size Range (NPS)	2" - 20"
7. End Connection	RTJ
8. Pressure Class	1500
9. Temperature	-100°C to 400°C
10. Material Class	Stainless Steel
11. Body Material	ASTM A182 Gr F316
12. TRIM Material	TRIM 12 according API 594
13. Obturator Material	AISI 316
14. Seat Material	Stellite (Co-Cr Alloy acc. item A.8.2.1.2)
15. Spring Material	UNS N07718
16. Shaft Material	ASTM A276 (UNS S31600)
17. Additional Requirement	Fire safe design (acc. item A.6.1.5)
18. Cover Construction	Not Applicable
19. Product testing	FAT according A.9.3
20. Cladding or Coating	N/A
21. Notes	wafer valves shall not to be used with flammable services.

Valve Code	VRE-1500-2-S215
Specs	G3
1. Valve Type	Check, Flanged type
2. Sealing Type	Metal to Metal
3. Valve Specification Level (VSL)	VSL-2
4. Obturator Type	Dual Plate
5. Standard	API 594
6. Size Range (NPS)	2" - 20"
7. End Connection	RTJ
8. Pressure Class	1500
9. Temperature	-100°C to 400°C
10. Material Class	Stainless Steel
11. Body Material	ASTM A182 Gr F316
12. TRIM Material	TRIM 12 according API 594
13. Obturator Material	AISI 316
14. Seat Material	Stellite (Co-Cr Alloy acc. item A.8.2.1.2)
15. Spring Material	UNS N07718
16. Shaft Material	ASTM A276 (UNS S31600)
17. Additional Requirement	Fire safe design (acc. item A.6.1.5)
18. Cover Construction	Not Applicable
19. Product testing	FAT according A.9.3
20. Cladding or Coating	N/A
21. Notes	N/A

Valve Code	VRE-1500-2-S235
Specs	G3
1. Valve Type	Check, Flanged type
2. Sealing Type	Metal to Metal
3. Valve Specification Level (VSL)	VSL-2
4. Obturator Type	Axial non-slam
5. Standard	API 6D
6. Size Range (NPS)	2" - 20"
7. End Connection	RTJ
8. Pressure Class	1500
9. Temperature	-100°C to 210°C
10. Material Class	Stainless Steel
11. Body Material	ASTM A182 Gr F316
12. TRIM Material	N/A
13. Obturator Material	AISI 316
14. Seat Material	AISI 316
15. Spring Material	UNS N07718
16. Shaft Material	Not Applicable
17. Additional Requirement	Fire safe design (acc. item A.6.1.5)
18. Cover Construction	Not Applicable
19. Product testing	FAT according A.9.3
20. Cladding or Coating	N/A
21. Notes	N/A

Valve Code	VRE-150-1-C111
Specs	B9 B10
1. Valve Type	Check, wafer type
2. Sealing Type	Soft
3. Valve Specification Level (VSL)	VSL-1
4. Obturator Type	Dual Plate
5. Standard	API 594
6. Size Range (NPS)	2" - 44"
7. End Connection	RF
8. Pressure Class	150
9. Temperature	0°C to 150°C
10. Material Class	Carbon Steel
11. Body Material	ASTM A105 or ASTM A216 Gr WCB
12. TRIM Material	TRIM 1 according API 594
13. Obturator Material	AISI 410
14. Seat Material	Group A (acc. item A.7.3.3.1)
15. Spring Material	UNS N07750
16. Shaft Material	ASTM A276 (UNS S41000)
17. Additional Requirement	N/A
18. Cover Construction	Not Applicable
19. Product testing	FAT according A.9.3
20. Cladding or Coating	N/A
21. Notes	wafer valves shall not to be used with flammable services.

Valve Code	VRE-150-1-C112
Specs	B10
1. Valve Type	Check, wafer type
2. Sealing Type	Metal to Metal
3. Valve Specification Level (VSL)	VSL-1
4. Obturator Type	Dual Plate
5. Standard	API 594
6. Size Range (NPS)	2" - 44"
7. End Connection	RF
8. Pressure Class	150
9. Temperature	-29°C to 400°C
10. Material Class	Carbon Steel
11. Body Material	ASTM A105 or ASTM A216 Gr WCB
12. TRIM Material	TRIM 8 according API 594
13. Obturator Material	AISI 410
14. Seat Material	Stellite (Co-Cr Alloy acc. item A.8.2.1.2)
15. Spring Material	UNS N07750
16. Shaft Material	ASTM A276 (UNS S41000)
17. Additional Requirement	Fire safe design (acc. item A.6.1.5)
18. Cover Construction	Not Applicable
19. Product testing	FAT according A.9.3
20. Cladding or Coating	N/A
21. Notes	wafer valves shall not to be used with flammable services.

Valve Code	VRE-150-1-C113
Specs	B4
1. Valve Type	Check, Wafer type
2. Sealing Type	Metal to Metal
3. Valve Specification Level (VSL)	VSL-1
4. Obturator Type	Dual Plate
5. Standard	API 594
6. Size Range (NPS)	2" - 24"
7. End Connection	RF
8. Pressure Class	150
9. Temperature	-29°C to 400°C
10. Material Class	Carbon Steel
11. Body Material	ASTM A105 or ASTM A216 Gr WCB
12. TRIM Material	TRIM 5 according API 594
13. Obturator Material	Stellite (Co-Cr Alloy acc. item A.8.2.1.2)
14. Seat Material	Stellite (Co-Cr Alloy acc. item A.8.2.1.2)
15. Spring Material	UNS N07750
16. Shaft Material	ASTM A276 (UNS S41000)
17. Additional Requirement	Fire safe design (acc. item A.6.1.5)
18. Cover Construction	Not Applicable
19. Product testing	FAT according A.9.3
20. Cladding or Coating	N/A
21. Notes	wafer valves shall not to be used with flammable services.





Valve Code	VRE-150-1-C211
Specs	B6
1. Valve Type	Check, wafer type
2. Sealing Type	Soft
3. Valve Specification Level (VSL)	VSL-1
4. Obturator Type	Dual Plate
5. Standard	API 594
6. Size Range (NPS)	2" - 36"
7. End Connection	RF
8. Pressure Class	150
9. Temperature	0°C to 345°C
10. Material Class	Low-Temperature Carbon Steel
11. Body Material	ASTM A350 Gr LF2 CL1 or ASTM A352 Gr LCC
12. TRIM Material	TRIM 10 according API 594
13. Obturator Material	AISI 316
14. Seat Material	Group A (acc. item A.7.3.3.1)
15. Spring Material	UNS N07750
16. Shaft Material	ASTM A276 (UNS S31600)
17. Additional Requirement	N/A
18. Cover Construction	Not Applicable
19. Product testing	FAT according A.9.3
20. Cladding or Coating	N/A
21. Notes	wafer valves shall not to be used with flammable services.

Valve Code	VRE-150-1-D111
Specs	B26
1. Valve Type	Check, wafer type
2. Sealing Type	Soft
3. Valve Specification Level (VSL)	VSL-1
4. Obturator Type	Dual Plate
5. Standard	API 594
6. Size Range (NPS)	2" - 24"
7. End Connection	FF
8. Pressure Class	150
9. Temperature	0°C to 150°C
10. Material Class	Duplex Steel
11. Body Material	ASTM A995 Gr 1b
12. TRIM Material	N/A
13. Obturator Material	Duplex (UNS S32550)
14. Seat Material	Group A (acc. item A.7.3.3.1)
15. Spring Material	UNS N06625
16. Shaft Material	ASTM A276 (UNS S31803)
17. Additional Requirement	N/A
18. Cover Construction	Not Applicable
19. Product testing	FAT according A.9.3
20. Cladding or Coating	N/A
21. Notes	Material suitable only for onshore application. Through holes drilled and tapped according to ASME B1.1.

Valve Code	VRE-150-1-D114
Specs	B11 B26
1. Valve Type	Check, wafer type
2. Sealing Type	Soft
3. Valve Specification Level (VSL)	VSL-1
4. Obturator Type	Dual Plate
5. Standard	API 594
6. Size Range (NPS)	2" - 28"
7. End Connection	RF
8. Pressure Class	150
9. Temperature	0°C to 150°C
10. Material Class	Duplex Steel
11. Body Material	ASTM A995 Gr 1b
12. TRIM Material	N/A
13. Obturator Material	Duplex (UNS S32550)
14. Seat Material	Group A (acc. item A.7.3.3.1)
15. Spring Material	UNS N06625
16. Shaft Material	ASTM A276 (UNS S31803)
17. Additional Requirement	N/A
18. Cover Construction	Not Applicable
19. Product testing	FAT according A.9.3
20. Cladding or Coating	N/A
21. Notes	Material suitable only for onshore application. Through holes drilled and tapped according to ASME B1.1.

Valve Code	VRE-150-1-D205
Specs	B11
1. Valve Type	Check
2. Sealing Type	Metal to Metal
3. Valve Specification Level (VSL)	VSL-1
4. Obturator Type	Piston
5. Standard	API 602
6. Size Range (NPS)	1" - 1 1/2"
7. End Connection	N/A
8. Pressure Class	150
9. Temperature	-46°C to 150°C
10. Material Class	Duplex Steel
11. Body Material	ASTM A182 Gr F51
12. TRIM Material	N/A
13. Obturator Material	Duplex (UNS S31803)
14. Seat Material	Super Duplex (UNS S32760)
15. Spring Material	N/A
16. Shaft Material	Not Applicable
17. Operator Type	N/A
18. Additional Requirement	N/A
19. Cover Construction	bolted cover
20. Product testing	FAT according A.9.3
21. Notes	N/A

Valve Code	VRE-150-1-D211
Specs	B11 B16
1. Valve Type	Check, wafer type
2. Sealing Type	Soft
3. Valve Specification Level (VSL)	VSL-1
4. Obturator Type	Dual Plate
5. Standard	API 594
6. Size Range (NPS)	2" - 36"
7. End Connection	RF
8. Pressure Class	150
9. Temperature	0°C to 150°C
10. Material Class	Duplex Steel
11. Body Material	ASTM A182 Gr F51 or ASTM A995 Gr 4A
12. TRIM Material	N/A
13. Obturator Material	Duplex (UNS S31803)
14. Seat Material	Group A (acc. item A.7.3.3.1)
15. Spring Material	UNS N06625
16. Shaft Material	ASTM A276 (UNS S31803)
17. Additional Requirement	N/A
18. Cover Construction	Not Applicable
19. Product testing	FAT according A.9.3
20. Cladding or Coating	N/A
21. Notes	wafer valves shall not to be used with flammable services.

Valve Code	VRE-150-1-D212
Specs	B11 B26
1. Valve Type	Check, wafer type
2. Sealing Type	Metal to Metal
3. Valve Specification Level (VSL)	VSL-1
4. Obturator Type	Dual Plate
5. Standard	API 594
6. Size Range (NPS)	2" - 28"
7. End Connection	RF
8. Pressure Class	150
9. Temperature	-46°C to 150°C
10. Material Class	Duplex Steel
11. Body Material	ASTM A182 Gr F51 or ASTM A995 Gr 4A
12. TRIM Material	N/A
13. Obturator Material	Duplex (UNS S31803)
14. Seat Material	Duplex (UNS S31803)
15. Spring Material	UNS N06625
16. Shaft Material	ASTM A276 (UNS S31803)
17. Additional Requirement	Fire safe design (acc. item A.6.1.5)
18. Cover Construction	Not Applicable
19. Product testing	FAT according A.9.3
20. Cladding or Coating	N/A
21. Notes	wafer valves shall not to be used with flammable services.

Valve Code	VRE-150-1-S211
Specs	B3
1. Valve Type	Check, wafer type
2. Sealing Type	Soft
3. Valve Specification Level (VSL)	VSL-1
4. Obturator Type	Dual Plate
5. Standard	API 594
6. Size Range (NPS)	2" - 36"
7. End Connection	RF
8. Pressure Class	150
9. Temperature	0°C to 150°C
10. Material Class	Stainless Steel
11. Body Material	ASTM A182 Gr F316 or ASTM A351 Gr CF8M
12. TRIM Material	TRIM 10 according API 594
13. Obturator Material	AISI 316
14. Seat Material	Group A (acc. item A.7.3.3.1)
15. Spring Material	UNS N07718
16. Shaft Material	ASTM A276 (UNS S31600)
17. Additional Requirement	N/A
18. Cover Construction	Not Applicable
19. Product testing	FAT according A.9.3
20. Cladding or Coating	N/A
21. Notes	wafer valves shall not to be used with flammable services.

Valve Code	VRE-150-1-S212
Specs	B3
1. Valve Type	Check, wafer type
2. Sealing Type	Metal to Metal
3. Valve Specification Level (VSL)	VSL-1
4. Obturator Type	Dual Plate
5. Standard	API 594
6. Size Range (NPS)	2" - 36"
7. End Connection	RF
8. Pressure Class	150
9. Temperature	-100°C to 400°C
10. Material Class	Stainless Steel
11. Body Material	ASTM A182 Gr F316 or ASTM A351 Gr CF8M
12. TRIM Material	TRIM 12 according API 594
13. Obturator Material	AISI 316
14. Seat Material	Stellite (Co-Cr Alloy acc. item A.8.2.1.2)
15. Spring Material	UNS N07718
16. Shaft Material	ASTM A276 (UNS S31600)
17. Additional Requirement	Fire safe design (acc. item A.6.1.5)
18. Cover Construction	Not Applicable
19. Product testing	FAT according A.9.3
20. Cladding or Coating	N/A
21. Notes	wafer valves shall not to be used with flammable services.

Valve Code	VRE-150-1-U305
Specs	B14 B22 B23
1. Valve Type	Check
2. Sealing Type	Metal to Metal
3. Valve Specification Level (VSL)	VSL-1
4. Obturator Type	Piston
5. Standard	API 602
6. Size Range (NPS)	1" - 2"
7. End Connection	N/A
8. Pressure Class	150
9. Temperature	0°C to 90°C
10. Material Class	Uncommon Materials
11. Body Material	ASTM B148 (UNS C95800)
12. TRIM Material	N/A
13. Obturator Material	ASTM B148 (UNS C95800)
14. Seat Material	ASTM B148 (UNS C95800)
15. Spring Material	N/A
16. Shaft Material	Not Applicable
17. Operator Type	N/A
18. Additional Requirement	N/A
19. Cover Construction	bolted cover
20. Product testing	FAT according A.9.3
21. Notes	N/A

Valve Code	VRE-150-1-U311
Specs	B7
1. Valve Type	Check, wafer type
2. Sealing Type	Soft
3. Valve Specification Level (VSL)	VSL-1
4. Obturator Type	Dual Plate
5. Standard	API 594
6. Size Range (NPS)	2" - 36"
7. End Connection	ASME B16.24, RF
8. Pressure Class	150
9. Temperature	0°C to 90°C
10. Material Class	Uncommon Materials
11. Body Material	ASTM B148 (UNS C95800)
12. TRIM Material	N/A
13. Obturator Material	ASTM B148 (UNS C95800)
14. Seat Material	Group A (acc. item A.7.3.3.1)
15. Spring Material	UNS N05500
16. Shaft Material	ASTM B150 (UNS C63200)
17. Additional Requirement	N/A
18. Cover Construction	Not Applicable
19. Product testing	FAT according A.9.3
20. Cladding or Coating	N/A
21. Notes	wafer valves shall not to be used with flammable services.

Valve Code	VRE-150-1-U312
Specs	B7 B23
1. Valve Type	Check, wafer type
2. Sealing Type	Metal to Metal
3. Valve Specification Level (VSL)	VSL-1
4. Obturator Type	Dual Plate
5. Standard	API 594
6. Size Range (NPS)	2" - 48"
7. End Connection	ASME B16.24, RF
8. Pressure Class	150
9. Temperature	0°C to 90°C
10. Material Class	Uncommon Materials
11. Body Material	ASTM B148 (UNS C95800)
12. TRIM Material	N/A
13. Obturator Material	ASTM B148 (UNS C95800)
14. Seat Material	ASTM B148 (UNS C95800)
15. Spring Material	UNS N05500
16. Shaft Material	ASTM B150 (UNS C63200)
17. Additional Requirement	N/A
18. Cover Construction	Not Applicable
19. Product testing	FAT according A.9.3
20. Cladding or Coating	N/A
21. Notes	wafer valves shall not to be used with flammable services.

Valve Code	VRE-150-1-U314
Specs	B14 B22 B23
1. Valve Type	Check, wafer type
2. Sealing Type	Soft
3. Valve Specification Level (VSL)	VSL-1
4. Obturator Type	Dual Plate
5. Standard	API 594
6. Size Range (NPS)	2" - 48"
7. End Connection	ASME B16.24, FF
8. Pressure Class	150
9. Temperature	0°C to 90°C
10. Material Class	Uncommon Materials
11. Body Material	ASTM B148 (UNS C95800)
12. TRIM Material	N/A
13. Obturator Material	ASTM B148 (UNS C95800)
14. Seat Material	Group A (acc. item A.7.3.3.1)
15. Spring Material	UNS N05500
16. Shaft Material	ASTM B150 (UNS C63200)
17. Additional Requirement	N/A
18. Cover Construction	Not Applicable
19. Product testing	FAT according A.9.3
20. Cladding or Coating	N/A
21. Notes	wafer valves shall not to be used with flammable services.

Valve Code	VRE-150-2-C112
Specs	B9 B10
1. Valve Type	Check, wafer type
2. Sealing Type	Metal to Metal
3. Valve Specification Level (VSL)	VSL-2
4. Obturator Type	Dual Plate
5. Standard	API 594
6. Size Range (NPS)	2" - 44"
7. End Connection	RF
8. Pressure Class	150
9. Temperature	-29°C to 400°C
10. Material Class	Carbon Steel
11. Body Material	ASTM A105 or ASTM A216 Gr WCB
12. TRIM Material	TRIM 8 according API 594
13. Obturator Material	AISI 410
14. Seat Material	Stellite (Co-Cr Alloy acc. item A.8.2.1.2)
15. Spring Material	UNS N07750
16. Shaft Material	ASTM A276 (UNS S41000)
17. Additional Requirement	Fire safe design (acc. item A.6.1.5)
18. Cover Construction	Not Applicable
19. Product testing	FAT according A.9.3
20. Cladding or Coating	N/A
21. Notes	wafer valves shall not to be used with flammable services.

Valve Code	VRE-150-2-C113
Specs	B4
1. Valve Type	Check, wafer type
2. Sealing Type	Metal to Metal
3. Valve Specification Level (VSL)	VSL-2
4. Obturator Type	Dual Plate
5. Standard	API 594
6. Size Range (NPS)	2" - 24"
7. End Connection	RF
8. Pressure Class	150
9. Temperature	-29°C to 400°C
10. Material Class	Carbon Steel
11. Body Material	ASTM A105 or ASTM A216 Gr WCB
12. TRIM Material	TRIM 5 according API 594
13. Obturator Material	Stellite (Co-Cr Alloy acc. item A.8.2.1.2)
14. Seat Material	Stellite (Co-Cr Alloy acc. item A.8.2.1.2)
15. Spring Material	UNS N07750
16. Shaft Material	ASTM A276 (UNS S41000)
17. Additional Requirement	Fire safe design (acc. item A.6.1.5)
18. Cover Construction	Not Applicable
19. Product testing	FAT according A.9.3
20. Cladding or Coating	N/A
21. Notes	wafer valves shall not to be used with flammable services.

Valve Code	VRE-150-2-C115
Specs	B9 B10
1. Valve Type	Check, Flanged type
2. Sealing Type	Metal to Metal
3. Valve Specification Level (VSL)	VSL-2
4. Obturator Type	Dual Plate
5. Standard	API 594
6. Size Range (NPS)	2" - 44"
7. End Connection	RF
8. Pressure Class	150
9. Temperature	-29°C to 400°C
10. Material Class	Carbon Steel
11. Body Material	ASTM A105 or ASTM A216 Gr WCB
12. TRIM Material	TRIM 8 according API 594
13. Obturator Material	AISI 410
14. Seat Material	Stellite (Co-Cr Alloy acc. item A.8.2.1.2)
15. Spring Material	UNS N07750
16. Shaft Material	ASTM A276 (UNS S41000)
17. Additional Requirement	Fire safe design (acc. item A.6.1.5)
18. Cover Construction	Not Applicable
19. Product testing	FAT according A.9.3
20. Cladding or Coating	N/A
21. Notes	N/A

Valve Code	VRE-150-2-C135
Specs	B9 B10
1. Valve Type	Check, Flanged type
2. Sealing Type	Metal to Metal
3. Valve Specification Level (VSL)	VSL-2
4. Obturator Type	Axial non-slam
5. Standard	API 6D
6. Size Range (NPS)	1" - 44"
7. End Connection	RF
8. Pressure Class	150
9. Temperature	-29°C to 210°C
10. Material Class	Carbon Steel
11. Body Material	ASTM A105 or ASTM A216 Gr WCB
12. TRIM Material	N/A
13. Obturator Material	AISI 410
14. Seat Material	AISI 410
15. Spring Material	UNS N07750
16. Shaft Material	Not Applicable
17. Additional Requirement	Fire safe design (acc. item A.6.1.5)
18. Cover Construction	Not Applicable
19. Product testing	FAT according A.9.3
20. Cladding or Coating	N/A
21. Notes	N/A



Valve Code	VRE-150-2-C212
Specs	B6
1. Valve Type	Check, Wafer type
2. Sealing Type	Metal to Metal
3. Valve Specification Level (VSL)	VSL-2
4. Obturator Type	Dual Plate
5. Standard	API 594
6. Size Range (NPS)	2" - 36"
7. End Connection	RF
8. Pressure Class	150
9. Temperature	-46°C to 345°C
10. Material Class	Low-Temperature Carbon Steel
11. Body Material	ASTM A350 Gr LF2 CL1 or ASTM A352 Gr LCC
12. TRIM Material	TRIM 12 according API 594
13. Obturator Material	AISI 316
14. Seat Material	Stellite (Co-Cr Alloy acc. item A.8.2.1.2)
15. Spring Material	UNS N07750
16. Shaft Material	ASTM A276 (UNS S31600)
17. Additional Requirement	Fire safe design (acc. item A.6.1.5)
18. Cover Construction	Not Applicable
19. Product testing	FAT according A.9.3
20. Cladding or Coating	N/A
21. Notes	wafer valves shall not to be used with flammable services.

Valve Code	VRE-150-2-C215
Specs	B6
1. Valve Type	Check, Flanged type
2. Sealing Type	Metal to Metal
3. Valve Specification Level (VSL)	VSL-2
4. Obturator Type	Dual Plate
5. Standard	API 594
6. Size Range (NPS)	2" - 36"
7. End Connection	RF
8. Pressure Class	150
9. Temperature	-46°C to 345°C
10. Material Class	Low-Temperature Carbon Steel
11. Body Material	ASTM A350 Gr LF2 CL1 or ASTM A352 Gr LCC
12. TRIM Material	TRIM 12 according API 594
13. Obturator Material	AISI 316
14. Seat Material	Stellite (Co-Cr Alloy acc. item A.8.2.1.2)
15. Spring Material	UNS N07750
16. Shaft Material	ASTM A276 (UNS S31600)
17. Additional Requirement	Fire safe design (acc. item A.6.1.5)
18. Cover Construction	Not Applicable
19. Product testing	FAT according A.9.3
20. Cladding or Coating	N/A
21. Notes	N/A

Valve Code	VRE-150-2-C235
Specs	B6
1. Valve Type	Check, Flanged type
2. Sealing Type	Metal to Metal
3. Valve Specification Level (VSL)	VSL-2
4. Obturator Type	Axial non-slam
5. Standard	API 6D
6. Size Range (NPS)	1" - 36"
7. End Connection	RF
8. Pressure Class	150
9. Temperature	-46°C to 210°C
10. Material Class	Low-Temperature Carbon Steel
11. Body Material	ASTM A350 Gr LF2 CL1 or ASTM A352 Gr LCC
12. TRIM Material	N/A
13. Obturator Material	AISI 316
14. Seat Material	AISI 316
15. Spring Material	UNS N07750
16. Shaft Material	Not Applicable
17. Additional Requirement	Fire safe design (acc. item A.6.1.5)
18. Cover Construction	Not Applicable
19. Product testing	FAT according A.9.3
20. Cladding or Coating	N/A
21. Notes	N/A

Valve Code	VRE-150-2-C515
Specs	B30
1. Valve Type	Check, Flanged type
2. Sealing Type	Metal to Metal
3. Valve Specification Level (VSL)	VSL-2
4. Obturator Type	Dual Plate
5. Standard	API 594
6. Size Range (NPS)	2" - 30"
7. End Connection	RF
8. Pressure Class	150
9. Temperature	-29°C to 400°C
10. Material Class	Carbon Steel with Cladding
11. Body Material	ASTM A105 or ASTM A216 Gr WCB + Inconel 625 weld overlay (acc. item A.7.1.7.3)
12. TRIM Material	N/A
13. Obturator Material	ASTM A105 + Inconel 625 weld overlay (acc. item A.7.1.7.3)
14. Seat Material	ASTM A105 + Inconel 625 weld overlay (acc. item A.7.1.7.3)
15. Spring Material	UNS N06625
16. Shaft Material	ASTM B637 (UNS N07718)
17. Additional Requirement	Fire safe design (acc. item A.6.1.5)
18. Cover Construction	Not Applicable
19. Product testing	FAT according A.9.3
20. Cladding or Coating	Full clad - Inconel 625 weld overlay on all wetted parts
21. Notes	N/A

Valve Code	VRE-150-2-C535
Specs	B30
1. Valve Type	Check, Flanged type
2. Sealing Type	Metal to Metal
3. Valve Specification Level (VSL)	VSL-2
4. Obturator Type	Axial non-slam
5. Standard	API 6D
6. Size Range (NPS)	2" - 30"
7. End Connection	RF
8. Pressure Class	150
9. Temperature	-29°C to 240°C
10. Material Class	Carbon Steel with Cladding
11. Body Material	ASTM A105 or ASTM A216 Gr WCB + Inconel 625 weld overlay (acc. item A.7.1.7.3)
12. TRIM Material	N/A
13. Obturator Material	ASTM A105 + Inconel 625 weld overlay (acc. item A.7.1.7.3)
14. Seat Material	ASTM A105 + Inconel 625 weld overlay (acc. item A.7.1.7.3)
15. Spring Material	UNS N06625
16. Shaft Material	Not Applicable
17. Additional Requirement	Fire safe design (acc. item A.6.1.5)
18. Cover Construction	Not Applicable
19. Product testing	FAT according A.9.3
20. Cladding or Coating	Full clad - Inconel 625 weld overlay on all wetted parts
21. Notes	N/A

Valve Code	VRE-150-2-D212
Specs	B11 B16
1. Valve Type	Check, wafer type
2. Sealing Type	Metal to Metal
3. Valve Specification Level (VSL)	VSL-2
4. Obturator Type	Dual Plate
5. Standard	API 594
6. Size Range (NPS)	2" - 36"
7. End Connection	RF
8. Pressure Class	150
9. Temperature	-46°C to 150°C
10. Material Class	Duplex Steel
11. Body Material	ASTM A182 Gr F51 or ASTM A995 Gr 4A
12. TRIM Material	N/A
13. Obturator Material	Duplex (UNS S31803)
14. Seat Material	Duplex (UNS S31803)
15. Spring Material	UNS N06625
16. Shaft Material	ASTM A276 (UNS S31803)
17. Additional Requirement	Fire safe design (acc. item A.6.1.5)
18. Cover Construction	Not Applicable
19. Product testing	FAT according A.9.3
20. Cladding or Coating	N/A
21. Notes	wafer valves shall not to be used with flammable services.

Valve Code	VRE-150-2-D215
Specs	B11 B16
1. Valve Type	Check, Flanged type
2. Sealing Type	Metal to Metal
3. Valve Specification Level (VSL)	VSL-2
4. Obturator Type	Dual Plate
5. Standard	API 594
6. Size Range (NPS)	2" - 36"
7. End Connection	RF
8. Pressure Class	150
9. Temperature	-46°C to 150°C
10. Material Class	Duplex Steel
11. Body Material	ASTM A182 Gr F51 or ASTM A995 Gr 4A
12. TRIM Material	N/A
13. Obturator Material	Duplex (UNS S31803)
14. Seat Material	Duplex (UNS S31803)
15. Spring Material	UNS N06625
16. Shaft Material	ASTM A276 (UNS S31803)
17. Additional Requirement	Fire safe design (acc. item A.6.1.5)
18. Cover Construction	Not Applicable
19. Product testing	FAT according A.9.3
20. Cladding or Coating	N/A
21. Notes	N/A

Valve Code	VRE-150-2-D235
Specs	B11 B16 B26
1. Valve Type	Check, Flanged type
2. Sealing Type	Metal to Metal
3. Valve Specification Level (VSL)	VSL-2
4. Obturator Type	Axial non-slam
5. Standard	API 6D
6. Size Range (NPS)	1" - 36"
7. End Connection	RF
8. Pressure Class	150
9. Temperature	-46°C to 150°C
10. Material Class	Duplex Steel
11. Body Material	ASTM A182 Gr F51 or ASTM A995 Gr 4A
12. TRIM Material	N/A
13. Obturator Material	Duplex (UNS S31803)
14. Seat Material	Duplex (UNS S31803)
15. Spring Material	UNS N06625
16. Shaft Material	Not Applicable
17. Additional Requirement	Fire safe design (acc. item A.6.1.5)
18. Cover Construction	Not Applicable
19. Product testing	FAT according A.9.3
20. Cladding or Coating	N/A
21. Notes	N/A

Valve Code	VRE-150-2-D305
Specs	B14 B23
1. Valve Type	Check
2. Sealing Type	Metal to Metal
3. Valve Specification Level (VSL)	VSL-2
4. Obturator Type	Piston
5. Standard	API 602
6. Size Range (NPS)	1" - 1 1/2"
7. End Connection	N/A
8. Pressure Class	150
9. Temperature	-46°C to 150°C
10. Material Class	Super Duplex Steel
11. Body Material	ASTM A182 Gr F55
12. TRIM Material	N/A
13. Obturator Material	Super Duplex (UNS S32760)
14. Seat Material	Super Duplex (UNS S32760)
15. Spring Material	N/A
16. Shaft Material	Not Applicable
17. Operator Type	N/A
18. Additional Requirement	N/A
19. Cover Construction	bolted cover
20. Product testing	FAT according A.9.3
21. Notes	N/A

Valve Code	VRE-150-2-D315
Specs	B12
1. Valve Type	Check, Flanged type
2. Sealing Type	Metal to Metal
3. Valve Specification Level (VSL)	VSL-2
4. Obturator Type	Dual Plate
5. Standard	API 594
6. Size Range (NPS)	2" - 36"
7. End Connection	RF
8. Pressure Class	150
9. Temperature	-46°C to 150°C
10. Material Class	Super Duplex Steel
11. Body Material	ASTM A182 Gr F55 or ASTM A995 Gr 6A
12. TRIM Material	N/A
13. Obturator Material	Super Duplex (UNS S32760)
14. Seat Material	Super Duplex (UNS S32760)
15. Spring Material	UNS N06625
16. Shaft Material	ASTM A276 (UNS S32760)
17. Additional Requirement	Fire safe design (acc. item A.6.1.5)
18. Cover Construction	Not Applicable
19. Product testing	FAT according A.9.3
20. Cladding or Coating	N/A
21. Notes	N/A

Valve Code	VRE-150-2-D335
Specs	B12
1. Valve Type	Check, Flanged type
2. Sealing Type	Metal to Metal
3. Valve Specification Level (VSL)	VSL-2
4. Obturator Type	Axial non-slam
5. Standard	API 6D
6. Size Range (NPS)	2" - 36"
7. End Connection	RF
8. Pressure Class	150
9. Temperature	-46°C to 150°C
10. Material Class	Super Duplex Steel
11. Body Material	ASTM A182 Gr F55 or ASTM A995 Gr 6A
12. TRIM Material	N/A
13. Obturator Material	Super Duplex (UNS S32760)
14. Seat Material	Super Duplex (UNS S32760)
15. Spring Material	UNS N06625
16. Shaft Material	Not Applicable
17. Additional Requirement	Fire safe design (acc. item A.6.1.5)
18. Cover Construction	Not Applicable
19. Product testing	FAT according A.9.3
20. Cladding or Coating	N/A
21. Notes	N/A

Valve Code	VRE-150-2-N153
Specs	B30
1. Valve Type	Check
2. Sealing Type	Metal to Metal
3. Valve Specification Level (VSL)	VSL-2
4. Obturator Type	Swing, spring-loaded, non-slam
5. Standard	API 6D
6. Size Range (NPS)	1" - 1 1/2"
7. End Connection	Flanged ASME B16.5, RF
8. Pressure Class	150
9. Temperature	-100°C to 400°C
10. Material Class	Nickel Alloys
11. Body Material	ASTM B564 (UNS N06625)
12. TRIM Material	N/A
13. Obturator Material	ASTM B564 (UNS N06625)
14. Seat Material	ASTM B564 (UNS N06625)
15. Spring Material	UNS N07750
16. Shaft Material	Not Applicable
17. Operator Type	N/A
18. Additional Requirement	N/A
19. Cover Construction	Not Applicable
20. Product testing	FAT according A.9.3
21. Notes	N/A

Valve Code	VRE-150-2-S212
Specs	B3
1. Valve Type	Check, wafer type
2. Sealing Type	Metal to Metal
3. Valve Specification Level (VSL)	VSL-2
4. Obturator Type	Dual Plate
5. Standard	API 594
6. Size Range (NPS)	2" - 36"
7. End Connection	RF
8. Pressure Class	150
9. Temperature	-100°C to 400°C
10. Material Class	Stainless Steel
11. Body Material	ASTM A182 Gr F316 or ASTM A351 Gr CF8M
12. TRIM Material	TRIM 12 according API 594
13. Obturator Material	AISI 316
14. Seat Material	Stellite (Co-Cr Alloy acc. item A.8.2.1.2)
15. Spring Material	UNS N07718
16. Shaft Material	ASTM A276 (UNS S31600)
17. Additional Requirement	Fire safe design (acc. item A.6.1.5)
18. Cover Construction	Not Applicable
19. Product testing	FAT according A.9.3
20. Cladding or Coating	N/A
21. Notes	wafer valves shall not to be used with flammable services.

Valve Code	VRE-150-2-S215
Specs	B3
1. Valve Type	Check, Flanged type
2. Sealing Type	Metal to Metal
3. Valve Specification Level (VSL)	VSL-2
4. Obturator Type	Dual Plate
5. Standard	API 594
6. Size Range (NPS)	2" - 36"
7. End Connection	RF
8. Pressure Class	150
9. Temperature	-100°C to 400°C
10. Material Class	Stainless Steel
11. Body Material	ASTM A182 Gr F316 or ASTM A351 Gr CF8M
12. TRIM Material	TRIM 12 according API 594
13. Obturator Material	AISI 316
14. Seat Material	Stellite (Co-Cr Alloy acc. item A.8.2.1.2)
15. Spring Material	UNS N07718
16. Shaft Material	ASTM A276 (UNS S31600)
17. Additional Requirement	Fire safe design (acc. item A.6.1.5)
18. Cover Construction	Not Applicable
19. Product testing	FAT according A.9.3
20. Cladding or Coating	N/A
21. Notes	N/A

Valve Code	VRE-150-2-S235
Specs	B3
1. Valve Type	Check, Flanged type
2. Sealing Type	Metal to Metal
3. Valve Specification Level (VSL)	VSL-2
4. Obturator Type	Axial non-slam
5. Standard	API 6D
6. Size Range (NPS)	1" - 36"
7. End Connection	RF
8. Pressure Class	150
9. Temperature	-100°C to 200°C
10. Material Class	Stainless Steel
11. Body Material	ASTM A182 Gr F316 or ASTM A351 Gr CF8M
12. TRIM Material	N/A
13. Obturator Material	AISI 316
14. Seat Material	AISI 316
15. Spring Material	UNS N07718
16. Shaft Material	Not Applicable
17. Additional Requirement	Fire safe design (acc. item A.6.1.5)
18. Cover Construction	Not Applicable
19. Product testing	FAT according A.9.3
20. Cladding or Coating	N/A
21. Notes	N/A

Valve Code	VRE-150-2-U335
Specs	B14 B23
1. Valve Type	Check, Flanged type
2. Sealing Type	Metal to Metal
3. Valve Specification Level (VSL)	VSL-2
4. Obturator Type	Axial non-slam
5. Standard	API 6D
6. Size Range (NPS)	2" - 40"
7. End Connection	ASME B16.24, FF
8. Pressure Class	150
9. Temperature	0°C to 90°C
10. Material Class	Uncommon Materials
11. Body Material	ASTM B148 (UNS C95800)
12. TRIM Material	N/A
13. Obturator Material	ASTM B148 (UNS C95800)
14. Seat Material	ASTM B148 (UNS C95800)
15. Spring Material	UNS N05500
16. Shaft Material	Not Applicable
17. Additional Requirement	N/A
18. Cover Construction	Not Applicable
19. Product testing	FAT according A.9.3
20. Cladding or Coating	N/A
21. Notes	N/A





Valve Code	VRE-150-2-U666
Specs	B14 B27
1. Valve Type	Check, Flanged type
2. Sealing Type	Soft
3. Valve Specification Level (VSL)	VSL-2
4. Obturator Type	Manufacturer Standard
5. Standard	Manufacturer Standard
6. Size Range (NPS)	2" - 6"
7. End Connection	ASME B16.24, FF
8. Pressure Class	150
9. Temperature	0°C to 70°C
10. Material Class	Uncommon Materials
11. Body Material	ASTM A395 60-40-18 + PFA liner
12. TRIM Material	N/A
13. Obturator Material	PFA
14. Seat Material	PFA
15. Spring Material	According manufacturer standard, fitted to service conditions
16. Shaft Material	Not Applicable
17. Additional Requirement	N/A
18. Cover Construction	Not Applicable
19. Product testing	FAT according manufacturer standard
20. Cladding or Coating	N/A
21. Notes	N/A

Valve Code	VRE-200-1-U122
Specs	B7
1. Valve Type	Check
2. Sealing Type	Metal to Metal
3. Valve Specification Level (VSL)	VSL-1
4. Obturator Type	Swing
5. Standard	MSS SP-80
6. Size Range (NPS)	½" - 1 ½"
7. End Connection	Screwed ends ASME B1.20.1 NPT
8. Pressure Class	max. press 200 psig
9. Temperature	0°C to 75°C
10. Material Class	Uncommon Materials
11. Body Material	ASTM B62 (UNS C83600)
12. TRIM Material	TRIM AA according API 594
13. Obturator Material	ASTM B62 (UNS C83600)
14. Seat Material	ASTM B62 (UNS C83600)
15. Spring Material	N/A
16. Shaft Material	Not Applicable
17. Operator Type	N/A
18. Additional Requirement	N/A
19. Cover Construction	screwed cover
20. Product testing	FAT according A.9.3
21. Notes	N/A

Valve Code	VRE-2500-1-D202
Specs	H16
1. Valve Type	Check
2. Sealing Type	Metal to Metal
3. Valve Specification Level (VSL)	VSL-1
4. Obturator Type	Piston
5. Standard	ASME B16.34 LTD
6. Size Range (NPS)	1" - 1 ½"
7. End Connection	butt weld ASME B16.25
8. Pressure Class	2500
9. Temperature	-46°C to 150°C
10. Material Class	Duplex Steel
11. Body Material	ASTM A182 Gr F51
12. TRIM Material	N/A
13. Obturator Material	Duplex (UNS S31803)
14. Seat Material	Duplex (UNS S31803)
15. Spring Material	N/A
16. Shaft Material	Not Applicable
17. Operator Type	N/A
18. Additional Requirement	Fire safe design (acc. item A.6.1.5)
19. Cover Construction	bolted cover
20. Product testing	FAT according A.9.3
21. Notes	N/A

Valve Code	VRE-2500-1-N102
Specs	H30
1. Valve Type	Check
2. Sealing Type	Metal to Metal
3. Valve Specification Level (VSL)	VSL-1
4. Obturator Type	Piston
5. Standard	ASME B16.34 LTD
6. Size Range (NPS)	1" - 1 ½"
7. End Connection	butt weld ASME B16.25
8. Pressure Class	2500
9. Temperature	-100°C to 400°C
10. Material Class	Nickel Alloys
11. Body Material	ASTM B564 (UNS N06625)
12. TRIM Material	N/A
13. Obturator Material	ASTM B564 (UNS N06625)
14. Seat Material	ASTM B564 (UNS N06625)
15. Spring Material	N/A
16. Shaft Material	Not Applicable
17. Operator Type	N/A
18. Additional Requirement	Fire safe design (acc. item A.6.1.5)
19. Cover Construction	bolted cover
20. Product testing	FAT according A.9.3
21. Notes	N/A

Valve Code	VRE-2500-2-D302
Specs	H12
1. Valve Type	Check
2. Sealing Type	Metal to Metal
3. Valve Specification Level (VSL)	VSL-2
4. Obturator Type	Piston
5. Standard	ASME B16.34 LTD
6. Size Range (NPS)	1" - 1 ½"
7. End Connection	butt weld ASME B16.25
8. Pressure Class	2500
9. Temperature	-50°C to 150°C
10. Material Class	Super Duplex Steel
11. Body Material	ASTM A182 Gr F55
12. TRIM Material	N/A
13. Obturator Material	Super Duplex (UNS S32760)
14. Seat Material	Super Duplex (UNS S32760)
15. Spring Material	N/A
16. Shaft Material	Not Applicable
17. Operator Type	N/A
18. Additional Requirement	Fire safe design (acc. item A.6.1.5)
19. Cover Construction	bolted cover
20. Product testing	FAT according A.9.3
21. Notes	N/A

Valve Code	VRE-2500-2-S202
Specs	H3
1. Valve Type	Check
2. Sealing Type	Metal to Metal
3. Valve Specification Level (VSL)	VSL-2
4. Obturator Type	Piston
5. Standard	ASME B16.34 LTD
6. Size Range (NPS)	1" - 1 ½"
7. End Connection	butt weld ASME B16.25
8. Pressure Class	2500
9. Temperature	-100°C to 400°C
10. Material Class	Stainless Steel
11. Body Material	ASTM A182 Gr F316/316L
12. TRIM Material	TRIM 12 according API 594
13. Obturator Material	AISI 316L
14. Seat Material	Stellite (Co-Cr Alloy acc. item A.8.2.1.2)
15. Spring Material	N/A
16. Shaft Material	Not Applicable
17. Operator Type	N/A
18. Additional Requirement	Fire safe design (acc. item A.6.1.5)
19. Cover Construction	bolted cover
20. Product testing	FAT according A.9.3
21. Notes	N/A

Valve Code	VRE-2510-2-C512
Specs	H30
1. Valve Type	Check, Wafer type
2. Sealing Type	Metal to Metal
3. Valve Specification Level (VSL)	VSL-2
4. Obturator Type	Dual Plate
5. Standard	API 594
6. Size Range (NPS)	2" - 24"
7. End Connection	ISO 27509, IX
8. Pressure Class	2500
9. Temperature	-29°C to 150°C
10. Material Class	Carbon Steel with Cladding
11. Body Material	ASTM A105 + Inconel 625 weld overlay (acc. item A.7.1.7.3)
12. TRIM Material	N/A
13. Obturator Material	ASTM A105 + Inconel 625 weld overlay (acc. item A.7.1.7.3)
14. Seat Material	ASTM A105 + Inconel 625 weld overlay (acc. item A.7.1.7.3)
15. Spring Material	UNS N06625
16. Shaft Material	ASTM B637 (UNS N07718)
17. Additional Requirement	Fire safe design (acc. item A.6.1.5)
18. Cover Construction	Not Applicable
19. Product testing	FAT according A.9.3
20. Cladding or Coating	Full clad - Inconel 625 weld overlay on all wetted parts
21. Notes	N/A

Valve Code	VRE-2510-2-C515
Specs	H30
1. Valve Type	Check, Flanged type
2. Sealing Type	Metal to Metal
3. Valve Specification Level (VSL)	VSL-2
4. Obturator Type	Dual Plate
5. Standard	API 594
6. Size Range (NPS)	2" - 24"
7. End Connection	ISO 27509, IX
8. Pressure Class	2500
9. Temperature	-29°C to 150°C
10. Material Class	Carbon Steel with Cladding
11. Body Material	ASTM A105 + Inconel 625 weld overlay (acc. item A.7.1.7.3)
12. TRIM Material	N/A
13. Obturator Material	ASTM A105 + Inconel 625 weld overlay (acc. item A.7.1.7.3)
14. Seat Material	ASTM A105 + Inconel 625 weld overlay (acc. item A.7.1.7.3)
15. Spring Material	UNS N06625
16. Shaft Material	ASTM B637 (UNS N07718)
17. Additional Requirement	Fire safe design (acc. item A.6.1.5)
18. Cover Construction	Not Applicable
19. Product testing	FAT according A.9.3
20. Cladding or Coating	Full clad - Inconel 625 weld overlay on all wetted parts
21. Notes	N/A

Valve Code	VRE-2510-2-C535
Specs	H30
1. Valve Type	Check, Flanged type
2. Sealing Type	Metal to Metal
3. Valve Specification Level (VSL)	VSL-2
4. Obturator Type	Axial non-slam
5. Standard	API 6D
6. Size Range (NPS)	2" - 24"
7. End Connection	ISO 27509, IX
8. Pressure Class	2500
9. Temperature	-29°C to 200°C
10. Material Class	Carbon Steel with Cladding
11. Body Material	ASTM A105 + Inconel 625 weld overlay (acc. item A.7.1.7.3)
12. TRIM Material	N/A
13. Obturator Material	ASTM A105 + Inconel 625 weld overlay (acc. item A.7.1.7.3)
14. Seat Material	ASTM A105 + Inconel 625 weld overlay (acc. item A.7.1.7.3)
15. Spring Material	UNS N06625
16. Shaft Material	Not Applicable
17. Additional Requirement	Fire safe design (acc. item A.6.1.5)
18. Cover Construction	Not Applicable
19. Product testing	FAT according A.9.3
20. Cladding or Coating	Full clad - Inconel 625 weld overlay on all wetted parts
21. Notes	N/A

Valve Code	VRE-2510-2-D212
Specs	H16
1. Valve Type	Check, wafer type
2. Sealing Type	Metal to Metal
3. Valve Specification Level (VSL)	VSL-2
4. Obturator Type	Dual Plate
5. Standard	API 594
6. Size Range (NPS)	2" - 24"
7. End Connection	ISO 27509, IX
8. Pressure Class	2500
9. Temperature	-46°C to 150°C
10. Material Class	Duplex Steel
11. Body Material	ASTM A182 Gr F51
12. TRIM Material	N/A
13. Obturator Material	Duplex (UNS S31803)
14. Seat Material	Duplex (UNS S31803)
15. Spring Material	UNS N06625
16. Shaft Material	ASTM A276 (UNS S31803)
17. Additional Requirement	Fire safe design (acc. item A.6.1.5)
18. Cover Construction	Not Applicable
19. Product testing	FAT according A.9.3
20. Cladding or Coating	N/A
21. Notes	wafer valves shall not to be used with flammable services.

Valve Code	VRE-2510-2-D215
Specs	H16
1. Valve Type	Check, Flanged type
2. Sealing Type	Metal to Metal
3. Valve Specification Level (VSL)	VSL-2
4. Obturator Type	Dual Plate
5. Standard	API 594
6. Size Range (NPS)	2" - 12"
7. End Connection	ISO 27509, IX
8. Pressure Class	2500
9. Temperature	-46°C to 150°C
10. Material Class	Duplex Steel
11. Body Material	ASTM A182 Gr F51
12. TRIM Material	N/A
13. Obturator Material	Duplex (UNS S31803)
14. Seat Material	Duplex (UNS S31803)
15. Spring Material	UNS N06625
16. Shaft Material	ASTM A276 (UNS S31803)
17. Additional Requirement	Fire safe design (acc. item A.6.1.5)
18. Cover Construction	Not Applicable
19. Product testing	FAT according A.9.3
20. Cladding or Coating	N/A
21. Notes	N/A

Valve Code	VRE-2510-2-D235
Specs	H16
1. Valve Type	Check, Flanged type
2. Sealing Type	Metal to Metal
3. Valve Specification Level (VSL)	VSL-2
4. Obturator Type	Axial non-slam
5. Standard	API 6D
6. Size Range (NPS)	2" - 12"
7. End Connection	ISO 27509, IX
8. Pressure Class	2500
9. Temperature	-46°C to 150°C
10. Material Class	Duplex Steel
11. Body Material	ASTM A182 Gr F51
12. TRIM Material	N/A
13. Obturator Material	Duplex (UNS S31803)
14. Seat Material	Duplex (UNS S31803)
15. Spring Material	UNS N06625
16. Shaft Material	ASTM A276 (UNS S31803)
17. Additional Requirement	Fire safe design (acc. item A.6.1.5)
18. Cover Construction	Not Applicable
19. Product testing	FAT according A.9.3
20. Cladding or Coating	N/A
21. Notes	N/A

Valve Code	VRE-2510-2-D315
Specs	H12
1. Valve Type	Check, Flanged type
2. Sealing Type	Metal to Metal
3. Valve Specification Level (VSL)	VSL-2
4. Obturator Type	Dual Plate
5. Standard	API 594
6. Size Range (NPS)	2" - 18"
7. End Connection	ISO 27509, IX
8. Pressure Class	2500
9. Temperature	-50°C to 150°C
10. Material Class	Super Duplex Steel
11. Body Material	ASTM A182 Gr F55
12. TRIM Material	N/A
13. Obturator Material	Super Duplex (UNS S32760)
14. Seat Material	Super Duplex (UNS S32760)
15. Spring Material	UNS N06625
16. Shaft Material	ASTM A276 (UNS S32760)
17. Additional Requirement	Fire safe design (acc. item A.6.1.5)
18. Cover Construction	Not Applicable
19. Product testing	FAT according A.9.3
20. Cladding or Coating	N/A
21. Notes	N/A

Valve Code	VRE-2510-2-D335
Specs	H12
1. Valve Type	Check, Flanged type
2. Sealing Type	Metal to Metal
3. Valve Specification Level (VSL)	VSL-2
4. Obturator Type	Axial non-slam
5. Standard	API 6D
6. Size Range (NPS)	1" - 18"
7. End Connection	ISO 27509, IX
8. Pressure Class	2500
9. Temperature	-50°C to 260°C
10. Material Class	Super Duplex Steel
11. Body Material	ASTM A182 Gr F55
12. TRIM Material	N/A
13. Obturator Material	ASTM A182 Gr F55
14. Seat Material	ASTM A182 Gr F55
15. Spring Material	UNS N06625
16. Shaft Material	Not Applicable
17. Additional Requirement	Fire safe design (acc. item A.6.1.5)
18. Cover Construction	Not Applicable
19. Product testing	FAT according A.9.3
20. Cladding or Coating	N/A
21. Notes	N/A

Valve Code	VRE-2510-2-S212
Specs	H3
1. Valve Type	Check, wafer type
2. Sealing Type	Metal to Metal
3. Valve Specification Level (VSL)	VSL-2
4. Obturator Type	Dual Plate
5. Standard	API 594
6. Size Range (NPS)	2" - 24"
7. End Connection	ISO 27509, IX
8. Pressure Class	2500
9. Temperature	-46°C to 210°C
10. Material Class	Stainless Steel
11. Body Material	ASTM A182 Gr F316
12. TRIM Material	TRIM 12 according API 594
13. Obturator Material	AISI 316
14. Seat Material	Stellite (Co-Cr Alloy acc. item A.8.2.1.2)
15. Spring Material	UNS N07718
16. Shaft Material	ASTM A276 (UNS S31600)
17. Additional Requirement	Fire safe design (acc. item A.6.1.5)
18. Cover Construction	Not Applicable
19. Product testing	FAT according A.9.3
20. Cladding or Coating	N/A
21. Notes	wafer valves shall not to be used with flammable services.

Valve Code	VRE-2510-2-S215
Specs	H3
1. Valve Type	Check, Flanged type
2. Sealing Type	Metal to Metal
3. Valve Specification Level (VSL)	VSL-2
4. Obturator Type	Dual Plate
5. Standard	API 594
6. Size Range (NPS)	2" - 16"
7. End Connection	ISO 27509, IX
8. Pressure Class	2500
9. Temperature	-100°C to 210°C
10. Material Class	Stainless Steel
11. Body Material	ASTM A182 Gr F316
12. TRIM Material	TRIM 12 according API 594
13. Obturator Material	AISI 316
14. Seat Material	Stellite (Co-Cr Alloy acc. item A.8.2.1.2)
15. Spring Material	UNS N07718
16. Shaft Material	ASTM A276 (UNS S31600)
17. Additional Requirement	Fire safe design (acc. item A.6.1.5)
18. Cover Construction	Not Applicable
19. Product testing	FAT according A.9.3
20. Cladding or Coating	N/A
21. Notes	N/A

Valve Code	VRE-2510-2-S235
Specs	H3
1. Valve Type	Check, Flanged type
2. Sealing Type	Metal to Metal
3. Valve Specification Level (VSL)	VSL-2
4. Obturator Type	Axial non-slam
5. Standard	API 6D
6. Size Range (NPS)	2" - 16"
7. End Connection	ISO 27509, IX
8. Pressure Class	2500
9. Temperature	-100°C to 210°C
10. Material Class	Stainless Steel
11. Body Material	ASTM A182 Gr F316 or ASTM A351 Gr CF8M
12. TRIM Material	N/A
13. Obturator Material	AISI 316
14. Seat Material	AISI 316
15. Spring Material	UNS N07718
16. Shaft Material	Not Applicable
17. Additional Requirement	Fire safe design (acc. item A.6.1.5)
18. Cover Construction	Not Applicable
19. Product testing	FAT according A.9.3
20. Cladding or Coating	N/A
21. Notes	N/A

Valve Code	VRE-300-1-C111
Specs	C8 C10
1. Valve Type	Check, wafer type
2. Sealing Type	Soft
3. Valve Specification Level (VSL)	VSL-1
4. Obturator Type	Dual Plate
5. Standard	API 594
6. Size Range (NPS)	2" - 24"
7. End Connection	RF
8. Pressure Class	300
9. Temperature	0°C to 150°C
10. Material Class	Carbon Steel
11. Body Material	ASTM A105 or ASTM A216 Gr WCB
12. TRIM Material	TRIM 1 according API 594
13. Obturator Material	AISI 410
14. Seat Material	Group A (acc. item A.7.3.3.1)
15. Spring Material	UNS N07750
16. Shaft Material	ASTM A276 (UNS S41000)
17. Additional Requirement	N/A
18. Cover Construction	Not Applicable
19. Product testing	FAT according A.9.3
20. Cladding or Coating	N/A
21. Notes	wafer valves shall not to be used with flammable services.

Valve Code	VRE-300-1-C112
Specs	C10
1. Valve Type	Check, wafer type
2. Sealing Type	Metal to Metal
3. Valve Specification Level (VSL)	VSL-1
4. Obturator Type	Dual Plate
5. Standard	API 594
6. Size Range (NPS)	2" - 24"
7. End Connection	RF
8. Pressure Class	300
9. Temperature	-29°C to 400°C
10. Material Class	Carbon Steel
11. Body Material	ASTM A105 or ASTM A216 Gr WCB
12. TRIM Material	TRIM 8 according API 594
13. Obturator Material	AISI 410
14. Seat Material	Stellite (Co-Cr Alloy acc. item A.8.2.1.2)
15. Spring Material	UNS N07750
16. Shaft Material	ASTM A276 (UNS S41000)
17. Additional Requirement	Fire safe design (acc. item A.6.1.5)
18. Cover Construction	Not Applicable
19. Product testing	FAT according A.9.3
20. Cladding or Coating	N/A
21. Notes	wafer valves shall not to be used with flammable services.

Valve Code	VRE-300-1-C211
Specs	C6
1. Valve Type	Check, wafer type
2. Sealing Type	Soft
3. Valve Specification Level (VSL)	VSL-1
4. Obturator Type	Dual Plate
5. Standard	API 594
6. Size Range (NPS)	2" - 30"
7. End Connection	RF
8. Pressure Class	300
9. Temperature	0°C to 150°C
10. Material Class	Low-Temperature Carbon Steel
11. Body Material	ASTM A350 Gr LF2 CL1 or ASTM A352 Gr LCC
12. TRIM Material	TRIM 10 according API 594
13. Obturator Material	AISI 316
14. Seat Material	Group A (acc. item A.7.3.3.1)
15. Spring Material	UNS N07750
16. Shaft Material	ASTM A276 (UNS S31600)
17. Additional Requirement	N/A
18. Cover Construction	Not Applicable
19. Product testing	FAT according A.9.3
20. Cladding or Coating	N/A
21. Notes	wafer valves shall not to be used with flammable services.

Valve Code	VRE-300-1-C512
Specs	C30
1. Valve Type	Check, wafer type
2. Sealing Type	Metal to Metal
3. Valve Specification Level (VSL)	VSL-1
4. Obturator Type	Dual Plate
5. Standard	API 594
6. Size Range (NPS)	2" - 30"
7. End Connection	RF
8. Pressure Class	300
9. Temperature	-29°C to 400°C
10. Material Class	Carbon Steel with Cladding
11. Body Material	ASTM A105 or ASTM A216 Gr WCB + Inconel 625 weld overlay (acc. item A.7.1.7.3)
12. TRIM Material	N/A
13. Obturator Material	ASTM A105 + Inconel 625 weld overlay (acc. item A.7.1.7.3)
14. Seat Material	ASTM A105 + Inconel 625 weld overlay (acc. item A.7.1.7.3)
15. Spring Material	UNS N06625
16. Shaft Material	ASTM B637 (UNS N07718)
17. Additional Requirement	Fire safe design (acc. item A.6.1.5)
18. Cover Construction	Not Applicable
19. Product testing	FAT according A.9.3
20. Cladding or Coating	Full clad - Inconel 625 weld overlay on all wetted parts
21. Notes	N/A

Valve Code	VRE-300-1-D205
Specs	C11
1. Valve Type	Check
2. Sealing Type	Metal to Metal
3. Valve Specification Level (VSL)	VSL-1
4. Obturator Type	Piston
5. Standard	API 602
6. Size Range (NPS)	1" - 1 1/2"
7. End Connection	N/A
8. Pressure Class	300
9. Temperature	-46°C to 150°C
10. Material Class	Duplex Steel
11. Body Material	ASTM A182 Gr F51
12. TRIM Material	N/A
13. Obturator Material	Duplex (UNS S31803)
14. Seat Material	Super Duplex (UNS S32760)
15. Spring Material	N/A
16. Shaft Material	Not Applicable
17. Operator Type	N/A
18. Additional Requirement	Fire safe design (acc. item A.6.1.5)
19. Cover Construction	bolting cover
20. Product testing	FAT according A.9.3
21. Notes	N/A

Valve Code	VRE-300-1-D211
Specs	C11 C16
1. Valve Type	Check, wafer type
2. Sealing Type	Soft
3. Valve Specification Level (VSL)	VSL-1
4. Obturator Type	Dual Plate
5. Standard	API 594
6. Size Range (NPS)	2" - 32"
7. End Connection	RF
8. Pressure Class	300
9. Temperature	0°C to 150°C
10. Material Class	Duplex Steel
11. Body Material	ASTM A182 Gr F51 or ASTM A995 Gr 4A
12. TRIM Material	N/A
13. Obturator Material	Duplex (UNS S31803)
14. Seat Material	Group A (acc. item A.7.3.3.1)
15. Spring Material	UNS N06625
16. Shaft Material	ASTM A276 (UNS S31803)
17. Additional Requirement	N/A
18. Cover Construction	Not Applicable
19. Product testing	FAT according A.9.3
20. Cladding or Coating	N/A
21. Notes	wafer valves shall not to be used with flammable services.

Valve Code	VRE-300-1-D212
Specs	C11
1. Valve Type	Check, wafer type
2. Sealing Type	Metal to Metal
3. Valve Specification Level (VSL)	VSL-1
4. Obturator Type	Dual Plate
5. Standard	API 594
6. Size Range (NPS)	2" - 20"
7. End Connection	RF
8. Pressure Class	300
9. Temperature	-46°C to 150°C
10. Material Class	Duplex Steel
11. Body Material	ASTM A182 Gr F51 or ASTM A995 Gr 4A
12. TRIM Material	N/A
13. Obturator Material	Duplex (UNS S31803)
14. Seat Material	Duplex (UNS S31803)
15. Spring Material	UNS N06625
16. Shaft Material	ASTM A276 (UNS S31803)
17. Additional Requirement	Fire safe design (acc. item A.6.1.5)
18. Cover Construction	Not Applicable
19. Product testing	FAT according A.9.3
20. Cladding or Coating	N/A
21. Notes	wafer valves shall not to be used with flammable services.

Valve Code	VRE-300-1-S211
Specs	C3
1. Valve Type	Check, wafer type
2. Sealing Type	Soft
3. Valve Specification Level (VSL)	VSL-1
4. Obturator Type	Dual Plate
5. Standard	API 594
6. Size Range (NPS)	2" - 30"
7. End Connection	RF
8. Pressure Class	300
9. Temperature	0°C to 150°C
10. Material Class	Stainless Steel
11. Body Material	ASTM A182 Gr F316 or ASTM A351 Gr CF8M
12. TRIM Material	TRIM 10 according API 594
13. Obturator Material	AISI 316
14. Seat Material	Group A (acc. item A.7.3.3.1)
15. Spring Material	UNS N07718
16. Shaft Material	ASTM A276 (UNS S31600)
17. Additional Requirement	N/A
18. Cover Construction	Not Applicable
19. Product testing	FAT according A.9.3
20. Cladding or Coating	N/A
21. Notes	wafer valves shall not to be used with flammable services.

Valve Code	VRE-300-1-U311
Specs	C23
1. Valve Type	Check, wafer type
2. Sealing Type	Soft
3. Valve Specification Level (VSL)	VSL-1
4. Obturator Type	Dual Plate
5. Standard	API 594
6. Size Range (NPS)	2" - 28"
7. End Connection	ASME B16.24, RF
8. Pressure Class	300
9. Temperature	0°C to 90°C
10. Material Class	Uncommon Materials
11. Body Material	ASTM B148 (UNS C95800)
12. TRIM Material	N/A
13. Obturator Material	ASTM B148 (UNS C95800)
14. Seat Material	Group A (acc. item A.7.3.3.1)
15. Spring Material	UNS N05500
16. Shaft Material	ASTM B150 (UNS C63200)
17. Additional Requirement	N/A
18. Cover Construction	Not Applicable
19. Product testing	FAT according A.9.3
20. Cladding or Coating	N/A
21. Notes	wafer valves shall not to be used with flammable services.

Valve Code	VRE-300-1-U312
Specs	C23
1. Valve Type	Check, wafer type
2. Sealing Type	Metal to Metal
3. Valve Specification Level (VSL)	VSL-1
4. Obturator Type	Dual Plate
5. Standard	API 594
6. Size Range (NPS)	2" - 28"
7. End Connection	ASME B16.24, RF
8. Pressure Class	300
9. Temperature	0°C to 90°C
10. Material Class	Uncommon Materials
11. Body Material	ASTM B148 (UNS C95800)
12. TRIM Material	N/A
13. Obturator Material	ASTM B148 (UNS C95800)
14. Seat Material	ASTM B148 (UNS C95800)
15. Spring Material	UNS N05500
16. Shaft Material	ASTM B150 (UNS C63200)
17. Additional Requirement	N/A
18. Cover Construction	Not Applicable
19. Product testing	FAT according A.9.3
20. Cladding or Coating	N/A
21. Notes	wafer valves shall not to be used with flammable services.

Valve Code	VRE-300-1-U315
Specs	C23
1. Valve Type	Check, Flanged type
2. Sealing Type	Metal to Metal
3. Valve Specification Level (VSL)	VSL-1
4. Obturator Type	Dual Plate
5. Standard	API 594
6. Size Range (NPS)	2" - 28"
7. End Connection	ASME B16.24, RF
8. Pressure Class	300
9. Temperature	0°C to 90°C
10. Material Class	Uncommon Materials
11. Body Material	ASTM B148 (UNS C95800)
12. TRIM Material	N/A
13. Obturator Material	ASTM B148 (UNS C95800)
14. Seat Material	ASTM B148 (UNS C95800)
15. Spring Material	UNS N05500
16. Shaft Material	ASTM B150 (UNS C63200)
17. Additional Requirement	N/A
18. Cover Construction	Not Applicable
19. Product testing	FAT according A.9.3
20. Cladding or Coating	N/A
21. Notes	wafer valves shall not to be used with flammable services.

Valve Code	VRE-300-2-C112
Specs	C10
1. Valve Type	Check, wafer type
2. Sealing Type	Metal to Metal
3. Valve Specification Level (VSL)	VSL-2
4. Obturator Type	Dual Plate
5. Standard	API 594
6. Size Range (NPS)	2" - 24"
7. End Connection	RF
8. Pressure Class	300
9. Temperature	-29°C to 400°C
10. Material Class	Carbon Steel
11. Body Material	ASTM A105 or ASTM A216 Gr WCB
12. TRIM Material	TRIM 8 according API 594
13. Obturator Material	AISI 410
14. Seat Material	Stellite (Co-Cr Alloy acc. item A.8.2.1.2)
15. Spring Material	UNS N07750
16. Shaft Material	ASTM A276 (UNS S41000)
17. Additional Requirement	Fire safe design (acc. item A.6.1.5)
18. Cover Construction	Not Applicable
19. Product testing	FAT according A.9.3
20. Cladding or Coating	N/A
21. Notes	wafer valves shall not to be used with flammable services.

Valve Code	VRE-300-2-C115
Specs	C10
1. Valve Type	Check, Flanged type
2. Sealing Type	Metal to Metal
3. Valve Specification Level (VSL)	VSL-2
4. Obturator Type	Dual Plate
5. Standard	API 594
6. Size Range (NPS)	2" - 24"
7. End Connection	RF
8. Pressure Class	300
9. Temperature	-29°C to 400°C
10. Material Class	Carbon Steel
11. Body Material	ASTM A105 or ASTM A216 Gr WCB
12. TRIM Material	TRIM 8 according API 594
13. Obturator Material	AISI 410
14. Seat Material	Stellite (Co-Cr Alloy acc. item A.8.2.1.2)
15. Spring Material	UNS N07750
16. Shaft Material	ASTM A276 (UNS S41000)
17. Additional Requirement	Fire safe design (acc. item A.6.1.5)
18. Cover Construction	Not Applicable
19. Product testing	FAT according A.9.3
20. Cladding or Coating	N/A
21. Notes	N/A

Valve Code	VRE-300-2-C135
Specs	C10
1. Valve Type	Check, Flanged type
2. Sealing Type	Metal to Metal
3. Valve Specification Level (VSL)	VSL-2
4. Obturator Type	Axial non-slam
5. Standard	API 6D
6. Size Range (NPS)	1" - 24"
7. End Connection	RF
8. Pressure Class	300
9. Temperature	-29°C to 210°C
10. Material Class	Carbon Steel
11. Body Material	ASTM A105 or ASTM A216 Gr WCB
12. TRIM Material	N/A
13. Obturator Material	AISI 410
14. Seat Material	AISI 410
15. Spring Material	UNS N07750
16. Shaft Material	Not Applicable
17. Additional Requirement	Fire safe design (acc. item A.6.1.5)
18. Cover Construction	Not Applicable
19. Product testing	FAT according A.9.3
20. Cladding or Coating	N/A
21. Notes	N/A

Valve Code	VRE-300-2-C212
Specs	C6
1. Valve Type	Check, wafer type
2. Sealing Type	Metal to Metal
3. Valve Specification Level (VSL)	VSL-2
4. Obturator Type	Dual Plate
5. Standard	API 594
6. Size Range (NPS)	2" - 30"
7. End Connection	RF
8. Pressure Class	300
9. Temperature	-46°C to 345°C
10. Material Class	Low-Temperature Carbon Steel
11. Body Material	ASTM A350 Gr LF2 CL1 or ASTM A352 Gr LCC
12. TRIM Material	TRIM 12 according API 594
13. Obturator Material	AISI 316
14. Seat Material	Stellite (Co-Cr Alloy acc. item A.8.2.1.2)
15. Spring Material	UNS N07750
16. Shaft Material	ASTM A276 (UNS S31600)
17. Additional Requirement	Fire safe design (acc. item A.6.1.5)
18. Cover Construction	Not Applicable
19. Product testing	FAT according A.9.3
20. Cladding or Coating	N/A
21. Notes	wafer valves shall not to be used with flammable services.





Valve Code	VRE-300-2-C215
Specs	C6
1. Valve Type	Check, Flanged type
2. Sealing Type	Metal to Metal
3. Valve Specification Level (VSL)	VSL-2
4. Obturator Type	Dual Plate
5. Standard	API 594
6. Size Range (NPS)	2" - 30"
7. End Connection	RF
8. Pressure Class	300
9. Temperature	-46°C to 345°C
10. Material Class	Low-Temperature Carbon Steel
11. Body Material	ASTM A350 Gr LF2 CL1 or ASTM A352 Gr LCC
12. TRIM Material	TRIM 12 according API 594
13. Obturator Material	AISI 316
14. Seat Material	Stellite (Co-Cr Alloy acc. item A.8.2.1.2)
15. Spring Material	UNS N07750
16. Shaft Material	ASTM A276 (UNS S31600)
17. Additional Requirement	Fire safe design (acc. item A.6.1.5)
18. Cover Construction	Not Applicable
19. Product testing	FAT according A.9.3
20. Cladding or Coating	N/A
21. Notes	N/A

Valve Code	VRE-300-2-C235
Specs	C6
1. Valve Type	Check, Flanged type
2. Sealing Type	Metal to Metal
3. Valve Specification Level (VSL)	VSL-2
4. Obturator Type	Axial non-slam
5. Standard	API 6D
6. Size Range (NPS)	2" - 30"
7. End Connection	RF
8. Pressure Class	300
9. Temperature	-46°C to 210°C
10. Material Class	Low-Temperature Carbon Steel
11. Body Material	ASTM A350 Gr LF2 CL1 or ASTM A352 Gr LCC
12. TRIM Material	N/A
13. Obturator Material	AISI 316
14. Seat Material	AISI 316
15. Spring Material	UNS N07750
16. Shaft Material	Not Applicable
17. Additional Requirement	Fire safe design (acc. item A.6.1.5)
18. Cover Construction	Not Applicable
19. Product testing	FAT according A.9.3
20. Cladding or Coating	N/A
21. Notes	N/A

Valve Code	VRE-300-2-C512
Specs	C30
1. Valve Type	Check, Wafer type
2. Sealing Type	Metal to Metal
3. Valve Specification Level (VSL)	VSL-2
4. Obturator Type	Dual Plate
5. Standard	API 594
6. Size Range (NPS)	2" - 30"
7. End Connection	RF
8. Pressure Class	300
9. Temperature	-29°C to 400°C
10. Material Class	Carbon Steel with Cladding
11. Body Material	ASTM A105 or ASTM A216 Gr WCB + Inconel 625 weld overlay (acc. item A.7.1.7.3)
12. TRIM Material	N/A
13. Obturator Material	ASTM A105 + Inconel 625 weld overlay (acc. item A.7.1.7.3)
14. Seat Material	ASTM A105 + Inconel 625 weld overlay (acc. item A.7.1.7.3)
15. Spring Material	UNS N06625
16. Shaft Material	ASTM B637 (UNS N07718)
17. Additional Requirement	Fire safe design (acc. item A.6.1.5)
18. Cover Construction	Not Applicable
19. Product testing	FAT according A.9.3
20. Cladding or Coating	Full clad - Inconel 625 weld overlay on all wetted parts
21. Notes	N/A

Valve Code	VRE-300-2-C515
Specs	C30
1. Valve Type	Check, Flanged type
2. Sealing Type	Metal to Metal
3. Valve Specification Level (VSL)	VSL-2
4. Obturator Type	Dual Plate
5. Standard	API 594
6. Size Range (NPS)	2" - 30"
7. End Connection	RF
8. Pressure Class	300
9. Temperature	-29°C to 400°C
10. Material Class	Carbon Steel with Cladding
11. Body Material	ASTM A105 or ASTM A216 Gr WCB + Inconel 625 weld overlay (acc. item A.7.1.7.3)
12. TRIM Material	N/A
13. Obturator Material	ASTM A105 + Inconel 625 weld overlay (acc. item A.7.1.7.3)
14. Seat Material	ASTM A105 + Inconel 625 weld overlay (acc. item A.7.1.7.3)
15. Spring Material	UNS N06625
16. Shaft Material	ASTM B637 (UNS N07718)
17. Additional Requirement	Fire safe design (acc. item A.6.1.5)
18. Cover Construction	Not Applicable
19. Product testing	FAT according A.9.3
20. Cladding or Coating	Full clad - Inconel 625 weld overlay on all wetted parts
21. Notes	N/A

Valve Code	VRE-300-2-C535
Specs	C30
1. Valve Type	Check, Flanged type
2. Sealing Type	Metal to Metal
3. Valve Specification Level (VSL)	VSL-2
4. Obturator Type	Axial non-slam
5. Standard	API 6D
6. Size Range (NPS)	2" - 30"
7. End Connection	RF
8. Pressure Class	300
9. Temperature	-29°C to 210°C
10. Material Class	Carbon Steel with Cladding
11. Body Material	ASTM A105 or ASTM A216 Gr WCB + Inconel 625 weld overlay (acc. item A.7.1.7.3)
12. TRIM Material	N/A
13. Obturator Material	ASTM A105 + Inconel 625 weld overlay (acc. item A.7.1.7.3)
14. Seat Material	ASTM A105 + Inconel 625 weld overlay (acc. item A.7.1.7.3)
15. Spring Material	UNS N06625
16. Shaft Material	Not Applicable
17. Additional Requirement	Fire safe design (acc. item A.6.1.5)
18. Cover Construction	Not Applicable
19. Product testing	FAT according A.9.3
20. Cladding or Coating	Full clad - Inconel 625 weld overlay on all wetted parts
21. Notes	N/A

Valve Code	VRE-300-2-D212
Specs	C11 C16
1. Valve Type	Check, wafer type
2. Sealing Type	Metal to Metal
3. Valve Specification Level (VSL)	VSL-2
4. Obturator Type	Dual Plate
5. Standard	API 594
6. Size Range (NPS)	2" - 32"
7. End Connection	RF
8. Pressure Class	300
9. Temperature	-46°C to 150°C
10. Material Class	Duplex Steel
11. Body Material	ASTM A182 Gr F51 or ASTM A995 Gr 4A
12. TRIM Material	N/A
13. Obturator Material	Duplex (UNS S31803)
14. Seat Material	Duplex (UNS S31803)
15. Spring Material	UNS N06625
16. Shaft Material	ASTM A276 (UNS S31803)
17. Additional Requirement	Fire safe design (acc. item A.6.1.5)
18. Cover Construction	Not Applicable
19. Product testing	FAT according A.9.3
20. Cladding or Coating	N/A
21. Notes	wafer valves shall not to be used with flammable services.

Valve Code	VRE-300-2-D215
Specs	C11 C16
1. Valve Type	Check, Flanged type
2. Sealing Type	Metal to Metal
3. Valve Specification Level (VSL)	VSL-2
4. Obturator Type	Dual Plate
5. Standard	API 594
6. Size Range (NPS)	2" - 32"
7. End Connection	RF
8. Pressure Class	300
9. Temperature	-46°C to 150°C
10. Material Class	Duplex Steel
11. Body Material	ASTM A182 Gr F51 or ASTM A995 Gr 4A
12. TRIM Material	N/A
13. Obturator Material	Duplex (UNS S31803)
14. Seat Material	Duplex (UNS S31803)
15. Spring Material	UNS N06625
16. Shaft Material	ASTM A276 (UNS S31803)
17. Additional Requirement	Fire safe design (acc. item A.6.1.5)
18. Cover Construction	Not Applicable
19. Product testing	FAT according A.9.3
20. Cladding or Coating	N/A
21. Notes	N/A

Valve Code	VRE-300-2-D235
Specs	C11 C16
1. Valve Type	Check, Flanged type
2. Sealing Type	Metal to Metal
3. Valve Specification Level (VSL)	VSL-2
4. Obturator Type	Axial non-slam
5. Standard	API 6D
6. Size Range (NPS)	1" - 32"
7. End Connection	RF
8. Pressure Class	300
9. Temperature	-46°C to 150°C
10. Material Class	Duplex Steel
11. Body Material	ASTM A182 Gr F51 or ASTM A995 Gr 4A
12. TRIM Material	N/A
13. Obturator Material	Duplex (UNS S31803)
14. Seat Material	Duplex (UNS S31803)
15. Spring Material	UNS N06625
16. Shaft Material	Not Applicable
17. Additional Requirement	Fire safe design (acc. item A.6.1.5)
18. Cover Construction	Not Applicable
19. Product testing	FAT according A.9.3
20. Cladding or Coating	N/A
21. Notes	N/A

Valve Code	VRE-300-2-N153
Specs	C30
1. Valve Type	Check
2. Sealing Type	Metal to Metal
3. Valve Specification Level (VSL)	VSL-2
4. Obturator Type	Swing, spring-loaded, non-slam
5. Standard	API 6D
6. Size Range (NPS)	1" - 1 1/2"
7. End Connection	Flanged ASME B16.5, RF
8. Pressure Class	300
9. Temperature	-100°C to 400°C
10. Material Class	Nickel Alloys
11. Body Material	ASTM B564 (UNS N06625)
12. TRIM Material	N/A
13. Obturator Material	ASTM B564 (UNS N06625)
14. Seat Material	ASTM B564 (UNS N06625)
15. Spring Material	UNS N07750
16. Shaft Material	Not Applicable
17. Operator Type	N/A
18. Additional Requirement	Fire safe design (acc. item A.6.1.5)
19. Cover Construction	Not Applicable
20. Product testing	FAT according A.9.3
21. Notes	N/A

Valve Code	VRE-300-2-S212
Specs	C3
1. Valve Type	Check, wafer type
2. Sealing Type	Metal to Metal
3. Valve Specification Level (VSL)	VSL-2
4. Obturator Type	Dual Plate
5. Standard	API 594
6. Size Range (NPS)	2" - 30"
7. End Connection	RF
8. Pressure Class	300
9. Temperature	-46°C to 150°C
10. Material Class	Stainless Steel
11. Body Material	ASTM A182 Gr F316 or ASTM A351 Gr CF8M
12. TRIM Material	TRIM 12 according API 594
13. Obturator Material	AISI 316
14. Seat Material	Stellite (Co-Cr Alloy acc. item A.8.2.1.2)
15. Spring Material	UNS N07718
16. Shaft Material	ASTM A276 (UNS S31600)
17. Additional Requirement	Fire safe design (acc. item A.6.1.5)
18. Cover Construction	Not Applicable
19. Product testing	FAT according A.9.3
20. Cladding or Coating	N/A
21. Notes	wafer valves shall not to be used with flammable services.

Valve Code	VRE-300-2-S215
Specs	C3
1. Valve Type	Check, Flanged type
2. Sealing Type	Metal to Metal
3. Valve Specification Level (VSL)	VSL-2
4. Obturator Type	Dual Plate
5. Standard	API 594
6. Size Range (NPS)	2" - 30"
7. End Connection	RF
8. Pressure Class	300
9. Temperature	-46°C to 150°C
10. Material Class	Stainless Steel
11. Body Material	ASTM A182 Gr F316 or ASTM A351 Gr CF8M
12. TRIM Material	TRIM 12 according API 594
13. Obturator Material	AISI 316
14. Seat Material	Stellite (Co-Cr Alloy acc. item A.8.2.1.2)
15. Spring Material	UNS N07718
16. Shaft Material	ASTM A276 (UNS S31600)
17. Additional Requirement	Fire safe design (acc. item A.6.1.5)
18. Cover Construction	Not Applicable
19. Product testing	FAT according A.9.3
20. Cladding or Coating	N/A
21. Notes	N/A

Valve Code	VRE-300-2-S235
Specs	C3
1. Valve Type	Check, Flanged type
2. Sealing Type	Metal to Metal
3. Valve Specification Level (VSL)	VSL-2
4. Obturator Type	Axial non-slam
5. Standard	API 6D
6. Size Range (NPS)	1" - 30"
7. End Connection	RF
8. Pressure Class	300
9. Temperature	-46°C to 150°C
10. Material Class	Stainless Steel
11. Body Material	ASTM A182 Gr F316 or ASTM A351 Gr CF8M
12. TRIM Material	N/A
13. Obturator Material	AISI 316
14. Seat Material	AISI 316
15. Spring Material	UNS N07718
16. Shaft Material	Not Applicable
17. Additional Requirement	Fire safe design (acc. item A.6.1.5)
18. Cover Construction	Not Applicable
19. Product testing	FAT according A.9.3
20. Cladding or Coating	N/A
21. Notes	N/A

Valve Code	VRE-300-2-U335
Specs	C23
1. Valve Type	Check, Flanged type
2. Sealing Type	Metal to Metal
3. Valve Specification Level (VSL)	VSL-2
4. Obturator Type	Axial non-slam
5. Standard	API 6D
6. Size Range (NPS)	2" - 28"
7. End Connection	ASME B16.24, FF
8. Pressure Class	300
9. Temperature	0°C to 90°C
10. Material Class	Uncommon Materials
11. Body Material	ASTM B148 (UNS C95800)
12. TRIM Material	N/A
13. Obturator Material	ASTM B148 (UNS C95800)
14. Seat Material	ASTM B148 (UNS C95800)
15. Spring Material	UNS N05500
16. Shaft Material	Not Applicable
17. Additional Requirement	N/A
18. Cover Construction	Not Applicable
19. Product testing	FAT according A.9.3
20. Cladding or Coating	N/A
21. Notes	N/A

Valve Code	VRE-600-1-C111
Specs	E8 E34
1. Valve Type	Check, wafer type
2. Sealing Type	Soft
3. Valve Specification Level (VSL)	VSL-1
4. Obturator Type	Dual Plate
5. Standard	API 594
6. Size Range (NPS)	2" - 4"
7. End Connection	RF
8. Pressure Class	600
9. Temperature	0°C to 150°C
10. Material Class	Carbon Steel
11. Body Material	ASTM A105 or ASTM A216 Gr WCB
12. TRIM Material	TRIM 1 according API 594
13. Obturator Material	AISI 410
14. Seat Material	Group A (acc. item A.7.3.3.1)
15. Spring Material	UNS N07750
16. Shaft Material	ASTM A276 (UNS S41000)
17. Additional Requirement	N/A
18. Cover Construction	Not Applicable
19. Product testing	FAT according A.9.3
20. Cladding or Coating	N/A
21. Notes	wafer valves shall not to be used with flammable services.

Valve Code	VRE-600-1-C211
Specs	E6 E19
1. Valve Type	Check, wafer type
2. Sealing Type	Soft
3. Valve Specification Level (VSL)	VSL-1
4. Obturator Type	Dual Plate
5. Standard	API 594
6. Size Range (NPS)	2" - 4"
7. End Connection	RF
8. Pressure Class	600
9. Temperature	0°C to 150°C
10. Material Class	Low-Temperature Carbon Steel
11. Body Material	ASTM A350 Gr LF2 CL1 or ASTM A352 Gr LCC
12. TRIM Material	TRIM 10 according API 594
13. Obturator Material	AISI 316
14. Seat Material	Group A (acc. item A.7.3.3.1)
15. Spring Material	UNS N07750
16. Shaft Material	ASTM A276 (UNS S31600)
17. Additional Requirement	N/A
18. Cover Construction	Not Applicable
19. Product testing	FAT according A.9.3
20. Cladding or Coating	N/A
21. Notes	wafer valves shall not to be used with flammable services.

Valve Code	VRE-600-1-D211
Specs	E16
1. Valve Type	Check, wafer type
2. Sealing Type	Soft
3. Valve Specification Level (VSL)	VSL-1
4. Obturator Type	Dual Plate
5. Standard	API 594
6. Size Range (NPS)	2" - 4"
7. End Connection	RF
8. Pressure Class	600
9. Temperature	0°C to 150°C
10. Material Class	Duplex Steel
11. Body Material	ASTM A182 Gr F51 or ASTM A995 Gr 4A
12. TRIM Material	N/A
13. Obturator Material	Duplex (UNS S31803)
14. Seat Material	Group A (acc. item A.7.3.3.1)
15. Spring Material	UNS N06625
16. Shaft Material	ASTM A276 (UNS S31803)
17. Additional Requirement	N/A
18. Cover Construction	Not Applicable
19. Product testing	FAT according A.9.3
20. Cladding or Coating	N/A
21. Notes	wafer valves shall not to be used with flammable services.





Valve Code	VRE-800-1-C103
Specs	B4
1. Valve Type	Check
2. Sealing Type	Metal to Metal
3. Valve Specification Level (VSL)	VSL-1
4. Obturator Type	Piston
5. Standard	API 602
6. Size Range (NPS)	½" - 1 ½"
7. End Connection	socket weld ends ASME B16.11
8. Pressure Class	800
9. Temperature	-29°C to 400°C
10. Material Class	Carbon Steel
11. Body Material	ASTM A105
12. TRIM Material	TRIM 5 according API 594
13. Obturator Material	Stellite (Co-Cr Alloy acc. item A.8.2.1.2)
14. Seat Material	Stellite (Co-Cr Alloy acc. item A.8.2.1.2)
15. Spring Material	N/A
16. Shaft Material	Not Applicable
17. Operator Type	N/A
18. Additional Requirement	Fire safe design (acc. item A.6.1.5)
19. Cover Construction	bolted cover
20. Product testing	FAT according A.9.3
21. Notes	N/A

Valve Code	VRE-800-1-C202
Specs	B6 C6
1. Valve Type	Check
2. Sealing Type	Metal to Metal
3. Valve Specification Level (VSL)	VSL-1
4. Obturator Type	Piston
5. Standard	API 602
6. Size Range (NPS)	½" - 1 ½"
7. End Connection	socket weld ends ASME B16.11
8. Pressure Class	800
9. Temperature	-46°C to 345°C
10. Material Class	Low-Temperature Carbon Steel
11. Body Material	ASTM A350 Gr LF2 CL1
12. TRIM Material	TRIM 12 according API 594
13. Obturator Material	AISI 316
14. Seat Material	Stellite (Co-Cr Alloy acc. item A.8.2.1.2)
15. Spring Material	N/A
16. Shaft Material	Not Applicable
17. Operator Type	N/A
18. Additional Requirement	Fire safe design (acc. item A.6.1.5)
19. Cover Construction	bolted cover
20. Product testing	FAT according A.9.3
21. Notes	N/A

Valve Code	VRE-800-1-D202
Specs	B16 C16 E16
1. Valve Type	Check
2. Sealing Type	Metal to Metal
3. Valve Specification Level (VSL)	VSL-1
4. Obturator Type	Piston
5. Standard	API 602
6. Size Range (NPS)	½" - 1 ½"
7. End Connection	socket weld ends ASME B16.11
8. Pressure Class	800
9. Temperature	-46°C to 150°C
10. Material Class	Duplex Steel
11. Body Material	ASTM A182 Gr F51
12. TRIM Material	N/A
13. Obturator Material	Duplex (UNS S31803)
14. Seat Material	Duplex (UNS S31803)
15. Spring Material	N/A
16. Shaft Material	Not Applicable
17. Operator Type	N/A
18. Additional Requirement	Fire safe design (acc. item A.6.1.5)
19. Cover Construction	bolted cover
20. Product testing	FAT according A.9.3
21. Notes	N/A

Valve Code	VRE-800-1-D302
Specs	B12
1. Valve Type	Check
2. Sealing Type	Metal to Metal
3. Valve Specification Level (VSL)	VSL-1
4. Obturator Type	Piston
5. Standard	API 602
6. Size Range (NPS)	½" - 1 ½"
7. End Connection	socket weld ends ASME B16.11
8. Pressure Class	800
9. Temperature	-46°C to 150°C
10. Material Class	Super Duplex Steel
11. Body Material	ASTM A182 Gr F55
12. TRIM Material	N/A
13. Obturator Material	Super Duplex (UNS S32760)
14. Seat Material	Super Duplex (UNS S32760)
15. Spring Material	N/A
16. Shaft Material	Not Applicable
17. Operator Type	N/A
18. Additional Requirement	Fire safe design (acc. item A.6.1.5)
19. Cover Construction	bolted cover
20. Product testing	FAT according A.9.3
21. Notes	N/A

Valve Code	VRE-800-1-N102
Specs	B30 C30
1. Valve Type	Check
2. Sealing Type	Metal to Metal
3. Valve Specification Level (VSL)	VSL-1
4. Obturator Type	Piston
5. Standard	API 602
6. Size Range (NPS)	½" - 1 ½"
7. End Connection	socket weld ends ASME B16.11
8. Pressure Class	800
9. Temperature	-100°C to 400°C
10. Material Class	Nickel Alloys
11. Body Material	ASTM B564 (UNS N06625)
12. TRIM Material	N/A
13. Obturator Material	ASTM B564 (UNS N06625)
14. Seat Material	ASTM B564 (UNS N06625)
15. Spring Material	N/A
16. Shaft Material	Not Applicable
17. Operator Type	N/A
18. Additional Requirement	Fire safe design (acc. item A.6.1.5)
19. Cover Construction	bolted cover
20. Product testing	FAT according A.9.3
21. Notes	N/A

Valve Code	VRE-800-1-S202
Specs	B3 C3
1. Valve Type	Check
2. Sealing Type	Metal to Metal
3. Valve Specification Level (VSL)	VSL-1
4. Obturator Type	Piston
5. Standard	API 602
6. Size Range (NPS)	½" - 1 ½"
7. End Connection	socket weld ends ASME B16.11
8. Pressure Class	800
9. Temperature	-100°C to 400°C
10. Material Class	Stainless Steel
11. Body Material	ASTM A182 Gr F316/316L
12. TRIM Material	N/A
13. Obturator Material	AISI 316L
14. Seat Material	Stellite (Co-Cr Alloy acc. item A.8.2.1.2)
15. Spring Material	N/A
16. Shaft Material	Not Applicable
17. Operator Type	N/A
18. Additional Requirement	Fire safe design (acc. item A.6.1.5)
19. Cover Construction	bolted cover
20. Product testing	FAT according A.9.3
21. Notes	N/A

Valve Code	VRE-800-2-C102
Specs	B10 C10
1. Valve Type	Check
2. Sealing Type	Metal to Metal
3. Valve Specification Level (VSL)	VSL-2
4. Obturator Type	Piston
5. Standard	API 602
6. Size Range (NPS)	½" - 1 ½"
7. End Connection	socket weld ends ASME B16.11
8. Pressure Class	800
9. Temperature	-29°C to 400°C
10. Material Class	Carbon Steel
11. Body Material	ASTM A105
12. TRIM Material	TRIM 8 according API 594
13. Obturator Material	AISI 410
14. Seat Material	Stellite (Co-Cr Alloy acc. item A.8.2.1.2)
15. Spring Material	N/A
16. Shaft Material	Not Applicable
17. Operator Type	N/A
18. Additional Requirement	Fire safe design (acc. item A.6.1.5)
19. Cover Construction	bolted cover
20. Product testing	FAT according A.9.3
21. Notes	N/A

Valve Code	VRE-800-2-C103
Specs	B9 B10
1. Valve Type	Check
2. Sealing Type	Metal to Metal
3. Valve Specification Level (VSL)	VSL-2
4. Obturator Type	Piston
5. Standard	API 602
6. Size Range (NPS)	½" - 1 ½"
7. End Connection	socket weld ends ASME B16.11
8. Pressure Class	800
9. Temperature	-29°C to 400°C
10. Material Class	Carbon Steel
11. Body Material	ASTM A105
12. TRIM Material	TRIM 5 according API 594
13. Obturator Material	Stellite (Co-Cr Alloy acc. item A.8.2.1.2)
14. Seat Material	Stellite (Co-Cr Alloy acc. item A.8.2.1.2)
15. Spring Material	N/A
16. Shaft Material	Not Applicable
17. Operator Type	N/A
18. Additional Requirement	Fire safe design (acc. item A.6.1.5)
19. Cover Construction	bolted cover
20. Product testing	FAT according A.9.3
21. Notes	N/A

Valve Code	VRE-800-2-C202
Specs	B6 C6 E6 E19
1. Valve Type	Check
2. Sealing Type	Metal to Metal
3. Valve Specification Level (VSL)	VSL-2
4. Obturator Type	Piston
5. Standard	API 602
6. Size Range (NPS)	½" - 1 ½"
7. End Connection	socket weld ends ASME B16.11
8. Pressure Class	800
9. Temperature	-46°C to 345°C
10. Material Class	Low-Temperature Carbon Steel
11. Body Material	ASTM A350 Gr LF2 CL1
12. TRIM Material	TRIM 12 according API 594
13. Obturator Material	AISI 316
14. Seat Material	Stellite (Co-Cr Alloy acc. item A.8.2.1.2)
15. Spring Material	N/A
16. Shaft Material	Not Applicable
17. Operator Type	N/A
18. Additional Requirement	Fire safe design (acc. item A.6.1.5)
19. Cover Construction	bolted cover
20. Product testing	FAT according A.9.3
21. Notes	N/A

Valve Code	VRE-800-2-D202
Specs	B16 C16
1. Valve Type	Check
2. Sealing Type	Metal to Metal
3. Valve Specification Level (VSL)	VSL-2
4. Obturator Type	Piston
5. Standard	API 602
6. Size Range (NPS)	½" - 1 ½"
7. End Connection	socket weld ends ASME B16.11
8. Pressure Class	800
9. Temperature	-46°C to 150°C
10. Material Class	Duplex Steel
11. Body Material	ASTM A182 Gr F51
12. TRIM Material	N/A
13. Obturator Material	Duplex (UNS S31803)
14. Seat Material	Duplex (UNS S31803)
15. Spring Material	N/A
16. Shaft Material	Not Applicable
17. Operator Type	N/A
18. Additional Requirement	Fire safe design (acc. item A.6.1.5)
19. Cover Construction	bolted cover
20. Product testing	FAT according A.9.3
21. Notes	N/A

Valve Code	VRE-800-2-N102
Specs	B30 C30 E30
1. Valve Type	Check
2. Sealing Type	Metal to Metal
3. Valve Specification Level (VSL)	VSL-2
4. Obturator Type	Piston
5. Standard	API 602
6. Size Range (NPS)	½" - 1 ½"
7. End Connection	socket weld ends ASME B16.11
8. Pressure Class	800
9. Temperature	-100°C to 400°C
10. Material Class	Nickel Alloys
11. Body Material	ASTM B564 (UNS N06625)
12. TRIM Material	N/A
13. Obturator Material	ASTM B564 (UNS N06625)
14. Seat Material	ASTM B564 (UNS N06625)
15. Spring Material	N/A
16. Shaft Material	Not Applicable
17. Operator Type	N/A
18. Additional Requirement	Fire safe design (acc. item A.6.1.5)
19. Cover Construction	bolted cover
20. Product testing	FAT according A.9.3
21. Notes	N/A

Valve Code	VRE-800-2-S202
Specs	B3 C3 E3
1. Valve Type	Check
2. Sealing Type	Metal to Metal
3. Valve Specification Level (VSL)	VSL-2
4. Obturator Type	Piston
5. Standard	API 602
6. Size Range (NPS)	½" - 1 ½"
7. End Connection	socket weld ends ASME B16.11
8. Pressure Class	800
9. Temperature	-100°C to 400°C
10. Material Class	Stainless Steel
11. Body Material	ASTM A182 Gr F316/316L
12. TRIM Material	N/A
13. Obturator Material	AISI 316L
14. Seat Material	Stellite (Co-Cr Alloy acc. item A.8.2.1.2)
15. Spring Material	N/A
16. Shaft Material	Not Applicable
17. Operator Type	N/A
18. Additional Requirement	Fire safe design (acc. item A.6.1.5)
19. Cover Construction	bolted cover
20. Product testing	FAT according A.9.3
21. Notes	N/A

Valve Code	VRE-900-2-C212
Specs	F6
1. Valve Type	Check, Wafer type
2. Sealing Type	Metal to Metal
3. Valve Specification Level (VSL)	VSL-2
4. Obturator Type	Dual Plate
5. Standard	API 594
6. Size Range (NPS)	2" - 16"
7. End Connection	RTJ
8. Pressure Class	900
9. Temperature	-46°C to 150°C
10. Material Class	Low-Temperature Carbon Steel
11. Body Material	ASTM A350 Gr LF2 CL1 or ASTM A352 Gr LCC
12. TRIM Material	TRIM 12 according API 594
13. Obturator Material	AISI 316
14. Seat Material	Stellite (Co-Cr Alloy acc. item A.8.2.1.2)
15. Spring Material	UNS N07750
16. Shaft Material	ASTM A276 (UNS S31600)
17. Additional Requirement	Fire safe design (acc. item A.6.1.5)
18. Cover Construction	Not Applicable
19. Product testing	FAT according A.9.3
20. Cladding or Coating	N/A
21. Notes	wafer valves shall not be used with flammable services.

Valve Code	VRE-900-2-C215
Specs	F6
1. Valve Type	Check, Flanged type
2. Sealing Type	Metal to Metal
3. Valve Specification Level (VSL)	VSL-2
4. Obturator Type	Dual Plate
5. Standard	API 594
6. Size Range (NPS)	2" - 16"
7. End Connection	RTJ
8. Pressure Class	900
9. Temperature	-46°C to 340°C
10. Material Class	Low-Temperature Carbon Steel
11. Body Material	ASTM A350 Gr LF2 CL1 or ASTM A352 Gr LCC
12. TRIM Material	TRIM 12 according API 594
13. Obturator Material	AISI 316
14. Seat Material	Stellite (Co-Cr Alloy acc. item A.8.2.1.2)
15. Spring Material	UNS N07750
16. Shaft Material	ASTM A276 (UNS S31600)
17. Additional Requirement	Fire safe design (acc. item A.6.1.5)
18. Cover Construction	Not Applicable
19. Product testing	FAT according A.9.3
20. Cladding or Coating	N/A
21. Notes	N/A

Valve Code	VRE-900-2-C235
Specs	F6
1. Valve Type	Check, Flanged type
2. Sealing Type	Metal to Metal
3. Valve Specification Level (VSL)	VSL-2
4. Obturator Type	Axial non-slam
5. Standard	API 6D
6. Size Range (NPS)	2" - 20"
7. End Connection	RTJ
8. Pressure Class	900
9. Temperature	-46°C to 320°C
10. Material Class	Low-Temperature Carbon Steel
11. Body Material	ASTM A350 Gr LF2 CL1 or ASTM A352 Gr LCC
12. TRIM Material	N/A
13. Obturator Material	AISI 316
14. Seat Material	AISI 316
15. Spring Material	UNS N07750
16. Shaft Material	Not Applicable
17. Additional Requirement	Fire safe design (acc. item A.6.1.5)
18. Cover Construction	Not Applicable
19. Product testing	FAT according A.9.3
20. Cladding or Coating	N/A
21. Notes	N/A



A.12.6 BUTTERFLY VALVES

Valve Code	VBO-150-1-U204
Specs	B22
1. Valve Type	Butterfly, Lug type
2. Sealing Type	Soft
3. Valve Specification Level (VSL)	VSL-1
4. Disc & Seat Configuration	Concentric, trim 1
5. Standard	API 609 Category A
6. Size Range (NPS)	2" - 20"
7. End Connection	ASME B16.5, FF
8. Pressure Class	max. press 150 psig
9. Temperature	0°C to 75°C
10. Material Class	Uncommon Materials
11. Body Material	ASTM A536 Gr. 65-45-12
12. Disc Material	ASTM B148 (UNS C95800)
13. Seat Material	FKM
14. Seal Ring	N/A
15. Stem Material	Monel K500
16. Stem Seal Material	According manufacturer standard, fitted to service conditions
17. Operator Type	2" - 8" Lever 10" - 20" Gearbox
18. Additional Requirement	Dead-end Service per API 609.
19. Product testing	FAT according A.9.3
20. Disc Coating	N/A
21. Notes	Through holes drilled and tapped according to ASME B1.1.

Valve Code	VBO-150-1-U206
Specs	B22
1. Valve Type	Butterfly, Double Flanged (short pattern)
2. Sealing Type	Soft
3. Valve Specification Level (VSL)	VSL-1
4. Disc & Seat Configuration	Concentric, trim 1
5. Standard	API 609 Category A
6. Size Range (NPS)	24" - 46"
7. End Connection	ASME B16.47, FF
8. Pressure Class	max. press 150 psig
9. Temperature	0°C to 75°C
10. Material Class	Uncommon Materials
11. Body Material	ASTM A536 Gr. 65-45-12
12. Disc Material	ASTM B148 (UNS C95800)
13. Seat Material	FKM
14. Seal Ring	N/A
15. Stem Material	Monel K500
16. Stem Seal Material	According manufacturer standard, fitted to service conditions
17. Operator Type	Gearbox
18. Additional Requirement	Dead-end Service per API 609.
19. Product testing	FAT according A.9.3
20. Disc Coating	N/A
21. Notes	N/A

Valve Code	VBO-150-2-C111
Specs	B4 B9 B10 B28
1. Valve Type	Butterfly, Lug type
2. Sealing Type	Soft
3. Valve Specification Level (VSL)	VSL-2
4. Disc & Seat Configuration	Double Offset
5. Standard	API 609 Category B
6. Size Range (NPS)	3" - 20"
7. End Connection	RF
8. Pressure Class	150
9. Temperature	-29°C to 150°C
10. Material Class	Carbon Steel
11. Body Material	ASTM A105 or ASTM A216 Gr WCB
12. Disc Material	AISI 410 + ENP (acc. Item A.8.2.1.1)
13. Seat Material	RPTFE
14. Seal Ring	N/A
15. Stem Material	ASTM A276 (UNS S41000)
16. Stem Seal Material	According manufacturer standard, fitted to service conditions
17. Operator Type	3" - 6" Lever 8" - 20" Gearbox
18. Additional Requirement	Dead-end Service per API 609.
19. Product testing	FAT according A.9.3
20. Disc Coating	Electroless Nickel Plating (ENP)
21. Notes	Through holes drilled and tapped according to ASME B1.1.

Valve Code	VBO-150-2-C113
Specs	B4 B9 B10 B28
1. Valve Type	Butterfly, Double Flanged (short pattern)
2. Sealing Type	Soft
3. Valve Specification Level (VSL)	VSL-2
4. Disc & Seat Configuration	Double Offset
5. Standard	API 609 Category B
6. Size Range (NPS)	24" - 38"
7. End Connection	RF
8. Pressure Class	150
9. Temperature	-29°C to 200°C
10. Material Class	Carbon Steel
11. Body Material	ASTM A105 or ASTM A216 Gr WCB
12. Disc Material	AISI 410 + ENP (acc. Item A.8.2.1.1)
13. Seat Material	RPTFE
14. Seal Ring	N/A
15. Stem Material	ASTM A276 (UNS S41000)
16. Stem Seal Material	According manufacturer standard, fitted to service conditions
17. Operator Type	Gearbox
18. Additional Requirement	Dead-end Service per API 609.
19. Product testing	FAT according A.9.3
20. Disc Coating	Electroless Nickel Plating (ENP)
21. Notes	N/A

Valve Code	VBO-150-2-C131
Specs	B9 B10
1. Valve Type	Butterfly, Lug type
2. Sealing Type	Soft
3. Valve Specification Level (VSL)	VSL-2
4. Disc & Seat Configuration	Double Offset, metal-seated
5. Standard	API 609 Category B
6. Size Range (NPS)	6" - 20"
7. End Connection	RF
8. Pressure Class	150
9. Temperature	-29°C to 240°C
10. Material Class	Carbon Steel
11. Body Material	ASTM A105 or ASTM A216 Gr WCB
12. Disc Material	AISI 410 + ENP (acc. Item A.8.2.1.1)
13. Seat Material	AISI 316 + Metallic Coating (acc. Item A.7.5.4.3.2)
14. Seal Ring	N/A
15. Stem Material	ASTM A276 (UNS S41000)
16. Stem Seal Material	According manufacturer standard, fitted to service conditions
17. Operator Type	6" - 8" Lever 8" - 20" Gearbox
18. Additional Requirement	Dead-end Service per API 609.
19. Product testing	FAT according A.9.3
20. Disc Coating	Electroless Nickel Plating (ENP)
21. Notes	Through holes drilled and tapped according to ASME B1.1.

Valve Code	VBO-150-2-C133
Specs	B9 B10
1. Valve Type	Butterfly, Double Flanged (short pattern)
2. Sealing Type	Soft
3. Valve Specification Level (VSL)	VSL-2
4. Disc & Seat Configuration	Double Offset, metal-seated
5. Standard	API 609 Category B
6. Size Range (NPS)	24" - 36"
7. End Connection	RF
8. Pressure Class	150
9. Temperature	-29°C to 240°C
10. Material Class	Carbon Steel
11. Body Material	ASTM A105 or ASTM A216 Gr WCB
12. Disc Material	AISI 410 + ENP (acc. Item A.8.2.1.1)
13. Seat Material	AISI 316 + Metallic Coating (acc. Item A.7.5.4.3.2)
14. Seal Ring	N/A
15. Stem Material	ASTM A276 (UNS S41000)
16. Stem Seal Material	According manufacturer standard, fitted to service conditions
17. Operator Type	Gearbox
18. Additional Requirement	Dead-end Service per API 609.
19. Product testing	FAT according A.9.3
20. Disc Coating	Electroless Nickel Plating (ENP)
21. Notes	N/A

Valve Code	VBO-150-2-C151
Specs	B10 B28
1. Valve Type	Butterfly, Lug type
2. Sealing Type	Soft
3. Valve Specification Level (VSL)	VSL-2
4. Disc & Seat Configuration	Double Offset, fire tested
5. Standard	API 609 Category B
6. Size Range (NPS)	3" - 20"
7. End Connection	RF
8. Pressure Class	150
9. Temperature	-29°C to 150°C
10. Material Class	Carbon Steel
11. Body Material	ASTM A105 or ASTM A216 Gr WCB
12. Disc Material	AISI 410 + ENP (acc. Item A.8.2.1.1)
13. Seat Material	RPTFE
14. Seal Ring	N/A
15. Stem Material	ASTM A276 (UNS S41000)
16. Stem Seal Material	According manufacturer standard, fitted to service conditions
17. Operator Type	3" - 6" Lever 8" - 20" Gearbox
18. Additional Requirement	Fire Tested (acc. item A.6.1.4). Dead-end Service per API 609.
19. Product testing	FAT according A.9.3
20. Disc Coating	Electroless Nickel Plating (ENP)
21. Notes	Through holes drilled and tapped according to ASME B1.1.

Valve Code	VBO-150-2-C153
Specs	B10 B28
1. Valve Type	Butterfly, Double Flanged (short pattern)
2. Sealing Type	Soft
3. Valve Specification Level (VSL)	VSL-2
4. Disc & Seat Configuration	Double Offset, fire tested
5. Standard	API 609 Category B
6. Size Range (NPS)	24" - 36"
7. End Connection	RF
8. Pressure Class	150
9. Temperature	-29°C to 150°C
10. Material Class	Carbon Steel
11. Body Material	ASTM A105 or ASTM A216 Gr WCB
12. Disc Material	AISI 410 + ENP (acc. Item A.8.2.1.1)
13. Seat Material	RPTFE
14. Seal Ring	N/A
15. Stem Material	ASTM A276 (UNS S41000)
16. Stem Seal Material	According manufacturer standard, fitted to service conditions
17. Operator Type	Gearbox
18. Additional Requirement	Fire Tested (acc. item A.6.1.4). Dead-end Service per API 609.
19. Product testing	FAT according A.9.3
20. Disc Coating	Electroless Nickel Plating (ENP)
21. Notes	Through holes drilled and tapped according to ASME B1.1.

Valve Code	VBO-150-2-C211
Specs	B6
1. Valve Type	Butterfly, Lug type
2. Sealing Type	Soft
3. Valve Specification Level (VSL)	VSL-2
4. Disc & Seat Configuration	Double Offset
5. Standard	API 609 Category B
6. Size Range (NPS)	6" - 20"
7. End Connection	RF
8. Pressure Class	150
9. Temperature	-46°C to 200°C
10. Material Class	Carbon Steel
11. Body Material	ASTM A350 Gr LF2 CL1 or ASTM A352 Gr LCC
12. Disc Material	AISI 316
13. Seat Material	RPTFE
14. Seal Ring	N/A
15. Stem Material	ASTM A276 (UNS S31600)
16. Stem Seal Material	According manufacturer standard, fitted to service conditions
17. Operator Type	6" - 8" Lever 8" - 20" Gearbox
18. Additional Requirement	Dead-end Service per API 609.
19. Product testing	FAT according A.9.3
20. Disc Coating	N/A
21. Notes	N/A

Valve Code	VBO-150-2-C213
Specs	B6
1. Valve Type	Butterfly, Double Flanged (short pattern)
2. Sealing Type	Soft
3. Valve Specification Level (VSL)	VSL-2
4. Disc & Seat Configuration	Double Offset
5. Standard	API 609 Category B
6. Size Range (NPS)	24" - 40"
7. End Connection	RF
8. Pressure Class	150
9. Temperature	-46°C to 200°C
10. Material Class	Carbon Steel
11. Body Material	ASTM A350 Gr LF2 CL1 or ASTM A352 Gr LCC
12. Disc Material	AISI 316
13. Seat Material	RPTFE
14. Seal Ring	N/A
15. Stem Material	ASTM A276 (UNS S31600)
16. Stem Seal Material	According manufacturer standard, fitted to service conditions
17. Operator Type	Gearbox
18. Additional Requirement	Dead-end Service per API 609.
19. Product testing	FAT according A.9.3
20. Disc Coating	N/A
21. Notes	N/A

Valve Code	VBO-150-2-D111
Specs	B26
1. Valve Type	Butterfly, Lug type
2. Sealing Type	Soft
3. Valve Specification Level (VSL)	VSL-2
4. Disc & Seat Configuration	Double Offset
5. Standard	API 609 Category B
6. Size Range (NPS)	6" - 20"
7. End Connection	FF
8. Pressure Class	150
9. Temperature	-29°C to 150°C
10. Material Class	Duplex Steel
11. Body Material	ASTM A995 Gr 1b
12. Disc Material	ASTM A995 Gr 1b
13. Seat Material	RPTFE
14. Seal Ring	N/A
15. Stem Material	ASTM A276 (UNS S32550)
16. Stem Seal Material	According manufacturer standard, fitted to service conditions
17. Operator Type	6" - 8" Lever 8" - 20" Gearbox
18. Additional Requirement	Dead-end Service per API 609.
19. Product testing	FAT according A.9.3
20. Disc Coating	N/A
21. Notes	Material suitable only for onshore application. Through holes drilled and tapped according to ASME B1.1.

Valve Code	VBO-150-2-D113
Specs	B26
1. Valve Type	Butterfly, Double Flanged (short pattern)
2. Sealing Type	Soft
3. Valve Specification Level (VSL)	VSL-2
4. Disc & Seat Configuration	Double Offset
5. Standard	API 609 Category B
6. Size Range (NPS)	24" - 36"
7. End Connection	FF
8. Pressure Class	150
9. Temperature	-29°C to 150°C
10. Material Class	Duplex Steel
11. Body Material	ASTM A995 Gr 1b
12. Disc Material	ASTM A995 Gr 1b
13. Seat Material	RPTFE
14. Seal Ring	N/A
15. Stem Material	ASTM A276 (UNS S32550)
16. Stem Seal Material	According manufacturer standard, fitted to service conditions
17. Operator Type	Gearbox
18. Additional Requirement	Dead-end Service per API 609.
19. Product testing	FAT according A.9.3
20. Disc Coating	N/A
21. Notes	Material suitable only for onshore application. Through holes drilled and tapped according to ASME B1.1.







Valve Code	VBO-150-3-S261
Specs	B3
1. Valve Type	Butterfly, Lug type
2. Sealing Type	Metal to Metal
3. Valve Specification Level (VSL)	VSL-3
4. Disc & Seat Configuration	Triple Offset, fire tested
5. Standard	API 609 Category B
6. Size Range (NPS)	3" - 20"
7. End Connection	RF
8. Pressure Class	150
9. Temperature	-100°C to 345°C
10. Material Class	Stainless Steel
11. Body Material	ASTM A182 Gr F316
12. Disc Material	AISI 316
13. Seat Material	AISI 316 + Metallic Coating (acc. Item A.7.5.4.3.2)
14. Seal Ring	Graphite Laminated with AISI 316
15. Stem Material	ASTM A276 (UNS S31600)
16. Stem Seal Material	Graphite Based Seal
17. Operator Type	Gearbox
18. Additional Requirement	Fire Tested (acc. item A.6.1.4). Dead-end Service per API 609.
19. Product testing	FAT according A.9.3
20. Disc Coating	N/A
21. Notes	Acceptance criteria for all HP/LP seat tests (Normative/Supplementary): ISO 5208 Rate A.

Valve Code	VBO-150-3-S263
Specs	B3
1. Valve Type	Butterfly, Double Flanged (short pattern)
2. Sealing Type	Metal to Metal
3. Valve Specification Level (VSL)	VSL-3
4. Disc & Seat Configuration	Triple Offset, fire tested
5. Standard	API 609 Category B
6. Size Range (NPS)	24" - 30"
7. End Connection	RF
8. Pressure Class	150
9. Temperature	-100°C to 345°C
10. Material Class	Stainless Steel
11. Body Material	ASTM A182 Gr F316
12. Disc Material	AISI 316
13. Seat Material	AISI 316 + Metallic Coating (acc. Item A.7.5.4.3.2)
14. Seal Ring	Graphite Laminated with AISI 316
15. Stem Material	ASTM A276 (UNS S31600)
16. Stem Seal Material	Graphite Based Seal
17. Operator Type	Gearbox
18. Additional Requirement	Fire Tested (acc. item A.6.1.4). Dead-end Service per API 609.
19. Product testing	FAT according A.9.3
20. Disc Coating	N/A
21. Notes	Acceptance criteria for all HP/LP seat tests (Normative/Supplementary): ISO 5208 Rate A.

Valve Code	VBO-150-3-U361
Specs	B7 B23
1. Valve Type	Butterfly, Lug type
2. Sealing Type	Metal to Metal
3. Valve Specification Level (VSL)	VSL-3
4. Disc & Seat Configuration	Triple Offset, fire tested
5. Standard	API 609 Category B
6. Size Range (NPS)	3" - 20"
7. End Connection	RF
8. Pressure Class	150
9. Temperature	-29°C to 75°C
10. Material Class	Uncommon Materials
11. Body Material	ASTM B148 (UNS C95800)
12. Disc Material	ASTM B148 (UNS C95800)
13. Seat Material	ASTM B148 (UNS C95800) + Metallic Coating (acc. Item A.7.5.4.3.2)
14. Seal Ring	Solid NAB (UNS C95800)
15. Stem Material	Monel K500
16. Stem Seal Material	PTFE
17. Operator Type	Gearbox
18. Additional Requirement	Fire Tested (acc. item A.6.1.4). Dead-end Service per API 609.
19. Product testing	FAT according A.9.3
20. Disc Coating	N/A
21. Notes	Acceptance criteria for all HP/LP seat tests (Normative/Supplementary): ISO 5208 Rate A.

Valve Code	VBO-150-3-U363
Specs	B7 B23
1. Valve Type	Butterfly, Double Flanged (short pattern)
2. Sealing Type	Metal to Metal
3. Valve Specification Level (VSL)	VSL-3
4. Disc & Seat Configuration	Triple Offset, fire tested
5. Standard	API 609 Category B
6. Size Range (NPS)	24" - 36"
7. End Connection	RF
8. Pressure Class	150
9. Temperature	-29°C to 75°C
10. Material Class	Uncommon Materials
11. Body Material	ASTM B148 (UNS C95800)
12. Disc Material	ASTM B148 (UNS C95800)
13. Seat Material	ASTM B148 (UNS C95800) + Metallic Coating (acc. Item A.7.5.4.3.2)
14. Seal Ring	Solid NAB (UNS C95800)
15. Stem Material	Monel K500
16. Stem Seal Material	PTFE
17. Operator Type	Gearbox
18. Additional Requirement	Fire Tested (acc. item A.6.1.4). Dead-end Service per API 609.
19. Product testing	FAT according A.9.3
20. Disc Coating	N/A
21. Notes	Acceptance criteria for all HP/LP seat tests (Normative/Supplementary): ISO 5208 Rate A.

Valve Code	VBO-150-3-U364
Specs	B14 B22
1. Valve Type	Butterfly, Lug type
2. Sealing Type	Metal to Metal
3. Valve Specification Level (VSL)	VSL-3
4. Disc & Seat Configuration	Triple Offset, fire tested
5. Standard	API 609 Category B
6. Size Range (NPS)	3" - 20"
7. End Connection	FF
8. Pressure Class	150
9. Temperature	-29°C to 75°C
10. Material Class	Uncommon Materials
11. Body Material	ASTM B148 (UNS C95800)
12. Disc Material	ASTM B148 (UNS C95800)
13. Seat Material	ASTM B148 (UNS C95800) + Metallic Coating (acc. Item A.7.5.4.3.2)
14. Seal Ring	Solid NAB (UNS C95800)
15. Stem Material	Monel K500
16. Stem Seal Material	PTFE
17. Operator Type	Gearbox
18. Additional Requirement	Fire Tested (acc. item A.6.1.4). Dead-end Service per API 609.
19. Product testing	FAT according A.9.3
20. Disc Coating	N/A
21. Notes	Acceptance criteria for all HP/LP seat tests (Normative/Supplementary): ISO 5208 Rate A.

Valve Code	VBO-150-3-U366
Specs	B14 B22
1. Valve Type	Butterfly, Double Flanged (short pattern)
2. Sealing Type	Metal to Metal
3. Valve Specification Level (VSL)	VSL-3
4. Disc & Seat Configuration	Triple Offset, fire tested
5. Standard	API 609 Category B
6. Size Range (NPS)	24" - 42"
7. End Connection	FF
8. Pressure Class	150
9. Temperature	-29°C to 75°C
10. Material Class	Uncommon Materials
11. Body Material	ASTM B148 (UNS C95800)
12. Disc Material	ASTM B148 (UNS C95800)
13. Seat Material	ASTM B148 (UNS C95800) + Metallic Coating (acc. Item A.7.5.4.3.2)
14. Seal Ring	Solid NAB (UNS C95800)
15. Stem Material	Monel K500
16. Stem Seal Material	PTFE
17. Operator Type	Gearbox
18. Additional Requirement	Fire Tested (acc. item A.6.1.4). Dead-end Service per API 609.
19. Product testing	FAT according A.9.3
20. Disc Coating	N/A
21. Notes	Acceptance criteria for all HP/LP seat tests (Normative/Supplementary): ISO 5208 Rate A.

Valve Code	VBO-250-1-U204
Specs	B14
1. Valve Type	Butterfly, Lug type
2. Sealing Type	Soft
3. Valve Specification Level (VSL)	VSL-1
4. Disc & Seat Configuration	Concentric, trim 1
5. Standard	API 609 Category A
6. Size Range (NPS)	2" - 20"
7. End Connection	ASME B16.5, FF
8. Pressure Class	max. press 250 psig
9. Temperature	0°C to 75°C
10. Material Class	Uncommon Materials
11. Body Material	ASTM A536 Gr. 65-45-12
12. Disc Material	ASTM B148 (UNS C95800)
13. Seat Material	FKM
14. Seal Ring	N/A
15. Stem Material	Monel K500
16. Stem Seal Material	According manufacturer standard, fitted to service conditions
17. Operator Type	2" - 8" Lever 10" - 20" Gearbox
18. Additional Requirement	Dead-end Service per API 609.
19. Product testing	FAT according A.9.3
20. Disc Coating	N/A
21. Notes	Through holes drilled and tapped according to ASME B1.1.

Valve Code	VBO-250-1-U206
Specs	B14
1. Valve Type	Butterfly, Double Flanged (short pattern)
2. Sealing Type	Soft
3. Valve Specification Level (VSL)	VSL-1
4. Disc & Seat Configuration	Concentric, trim 1
5. Standard	API 609 Category A
6. Size Range (NPS)	24" - 46"
7. End Connection	ASME B16.47, FF
8. Pressure Class	max. press 250 psig
9. Temperature	0°C to 75°C
10. Material Class	Uncommon Materials
11. Body Material	ASTM A536 Gr. 65-45-12
12. Disc Material	ASTM B148 (UNS C95800)
13. Seat Material	FKM
14. Seal Ring	N/A
15. Stem Material	Monel K500
16. Stem Seal Material	According manufacturer standard, fitted to service conditions
17. Operator Type	Gearbox
18. Additional Requirement	Dead-end Service per API 609.
19. Product testing	FAT according A.9.3
20. Disc Coating	N/A
21. Notes	N/A

Valve Code	VBO-250-1-U284
Specs	B11
1. Valve Type	Butterfly, Lug type
2. Sealing Type	Soft
3. Valve Specification Level (VSL)	VSL-1
4. Disc & Seat Configuration	Concentric, trim 3
5. Standard	API 609 Category A
6. Size Range (NPS)	2" - 20"
7. End Connection	ASME B16.47, RF
8. Pressure Class	max. press 250 psig
9. Temperature	0°C to 80°C
10. Material Class	Uncommon Materials
11. Body Material	ASTM A536 Gr. 65-45-12
12. Disc Material	Super Duplex (UNS S32760)
13. Seat Material	NBR
14. Seal Ring	N/A
15. Stem Material	ASTM A276 (UNS S31803)
16. Stem Seal Material	According manufacturer standard, fitted to service conditions
17. Operator Type	2" - 8" Lever 10" - 20" Gearbox
18. Additional Requirement	Dead-end Service per API 609.
19. Product testing	FAT according A.9.3
20. Disc Coating	N/A
21. Notes	N/A

Valve Code	VBO-250-1-U286
Specs	B11
1. Valve Type	Butterfly, Double Flanged (short pattern)
2. Sealing Type	Soft
3. Valve Specification Level (VSL)	VSL-1
4. Disc & Seat Configuration	Concentric, trim 3
5. Standard	API 609 Category A
6. Size Range (NPS)	24" - 28"
7. End Connection	ASME B16.47, RF
8. Pressure Class	max. press 250 psig
9. Temperature	0°C to 80°C
10. Material Class	Uncommon Materials
11. Body Material	ASTM A536 Gr. 65-45-12
12. Disc Material	Super Duplex (UNS S32760)
13. Seat Material	NBR
14. Seal Ring	N/A
15. Stem Material	ASTM A276 (UNS S31803)
16. Stem Seal Material	According manufacturer standard, fitted to service conditions
17. Operator Type	Gearbox
18. Additional Requirement	Dead-end Service per API 609.
19. Product testing	FAT according A.9.3
20. Disc Coating	N/A
21. Notes	N/A

Valve Code	VBO-250-1-U291
Specs	B3 B9 B10 B23 B28
1. Valve Type	Butterfly, Lug type
2. Sealing Type	Soft
3. Valve Specification Level (VSL)	VSL-1
4. Disc & Seat Configuration	Concentric, trim 4
5. Standard	API 609 Category A
6. Size Range (NPS)	2" - 20"
7. End Connection	ASME B16.5, RF
8. Pressure Class	max. press 250 psig
9. Temperature	0°C to 75°C
10. Material Class	Uncommon Materials
11. Body Material	ASTM A536 Gr. 65-45-12
12. Disc Material	ASTM B148 (UNS C95800)
13. Seat Material	NBR
14. Seal Ring	N/A
15. Stem Material	ASTM B150 (UNS C63200)
16. Stem Seal Material	According manufacturer standard, fitted to service conditions
17. Operator Type	2" - 8" Lever 10" - 20" Gearbox
18. Additional Requirement	Dead-end Service per API 609.
19. Product testing	FAT according A.9.3
20. Disc Coating	N/A
21. Notes	Through holes drilled and tapped according to ASME B1.1.

Valve Code	VBO-250-1-U293
Specs	B3 B9 B10 B23 B28
1. Valve Type	Butterfly, Double Flanged (short pattern)
2. Sealing Type	Soft
3. Valve Specification Level (VSL)	VSL-1
4. Disc & Seat Configuration	Concentric, trim 4
5. Standard	API 609 Category A
6. Size Range (NPS)	24" - 46"
7. End Connection	ASME B16.47, RF
8. Pressure Class	max. press 250 psig
9. Temperature	0°C to 75°C
10. Material Class	Uncommon Materials
11. Body Material	ASTM A536 Gr. 65-45-12
12. Disc Material	ASTM B148 (UNS C95800)
13. Seat Material	NBR
14. Seal Ring	N/A
15. Stem Material	ASTM B150 (UNS C63200)
16. Stem Seal Material	According manufacturer standard, fitted to service conditions
17. Operator Type	Gearbox
18. Additional Requirement	Dead-end Service per API 609.
19. Product testing	FAT according A.9.3
20. Disc Coating	N/A
21. Notes	N/A



Valve Code	VBO-300-2-C111
Specs	C10
1. Valve Type	Butterfly, Lug type
2. Sealing Type	Soft
3. Valve Specification Level (VSL)	VSL-2
4. Disc & Seat Configuration	Double Offset
5. Standard	API 609 Category B
6. Size Range (NPS)	3" - 20"
7. End Connection	RF
8. Pressure Class	300
9. Temperature	-29°C to 150°C
10. Material Class	Carbon Steel
11. Body Material	ASTM A105 or ASTM A216 Gr WCB
12. Disc Material	AISI 410 + ENP (acc. item A.8.2.1.1)
13. Seat Material	RPTFE
14. Seal Ring	N/A
15. Stem Material	ASTM A276 (UNS S41000)
16. Stem Seal Material	According manufacturer standard, fitted to service conditions
17. Operator Type	3" - 6" Lever 8" - 20" Gearbox
18. Additional Requirement	Dead-end Service per API 609.
19. Product testing	FAT according A.9.3
20. Disc Coating	Electroless Nickel Plating (ENP)
21. Notes	Through holes drilled and tapped according to ASME B1.1.

Valve Code	VBO-300-2-C113
Specs	C10
1. Valve Type	Butterfly, Double Flanged (short pattern)
2. Sealing Type	Soft
3. Valve Specification Level (VSL)	VSL-2
4. Disc & Seat Configuration	Double Offset
5. Standard	API 609 Category B
6. Size Range (NPS)	24" - 40"
7. End Connection	RF
8. Pressure Class	300
9. Temperature	0°C to 100°C
10. Material Class	Carbon Steel
11. Body Material	ASTM A105 or ASTM A216 Gr WCB
12. Disc Material	AISI 316
13. Seat Material	RPTFE
14. Seal Ring	N/A
15. Stem Material	ASTM A564 Type 630 H1150 (UNS S17400)
16. Stem Seal Material	According manufacturer standard, fitted to service conditions
17. Operator Type	Gearbox
18. Additional Requirement	Dead-end Service per API 609.
19. Product testing	FAT according A.9.3
20. Disc Coating	N/A
21. Notes	N/A

Valve Code	VBO-300-2-C511
Specs	C30
1. Valve Type	Butterfly, Lug type
2. Sealing Type	Soft
3. Valve Specification Level (VSL)	VSL-2
4. Disc & Seat Configuration	Double Offset
5. Standard	API 609 Category B
6. Size Range (NPS)	4" - 12"
7. End Connection	RF
8. Pressure Class	300
9. Temperature	-29°C to 150°C
10. Material Class	Carbon Steel with Cladding
11. Body Material	ASTM A105 or ASTM A216 Gr WCB
12. Disc Material	AISI 316 + Inconel 625 weld overlay (acc. item A.7.1.7.3)
13. Seat Material	RPTFE
14. Seal Ring	N/A
15. Stem Material	ASTM B637 (UNS N07718)
16. Stem Seal Material	PTFE
17. Operator Type	4" - 6" Lever 8" - 12" Gearbox
18. Additional Requirement	N/A
19. Product testing	FAT according A.9.3
20. Disc Coating	Full clad - Inconel 625 weld overlay on all wetted parts
21. Notes	Through holes drilled and tapped according to ASME B1.1.

Valve Code	VBO-300-2-C512
Specs	C30
1. Valve Type	Butterfly, wafer type
2. Sealing Type	Soft
3. Valve Specification Level (VSL)	VSL-2
4. Disc & Seat Configuration	Double Offset
5. Standard	API 609 Category B
6. Size Range (NPS)	4" - 12"
7. End Connection	RF
8. Pressure Class	300
9. Temperature	-29°C to 100°C
10. Material Class	Carbon Steel
11. Body Material	ASTM A105 or ASTM A216 Gr WCB
12. Disc Material	AISI 316 + Inconel 625 weld overlay (acc. item A.7.1.7.3)
13. Seat Material	RPTFE
14. Seal Ring	N/A
15. Stem Material	ASTM B637 (UNS N07718)
16. Stem Seal Material	According manufacturer standard, fitted to service conditions
17. Operator Type	4" - 6" Lever 8" - 12" Gearbox
18. Additional Requirement	N/A
19. Product testing	FAT according A.9.3
20. Disc Coating	Full clad - Inconel 625 weld overlay on all wetted parts
21. Notes	N/A

Valve Code	VBO-300-2-C513
Specs	C30
1. Valve Type	Butterfly, Double Flanged (short pattern)
2. Sealing Type	Soft
3. Valve Specification Level (VSL)	VSL-2
4. Disc & Seat Configuration	Double Offset
5. Standard	API 609 Category B
6. Size Range (NPS)	4" - 12"
7. End Connection	RF
8. Pressure Class	300
9. Temperature	-29°C to 150°C
10. Material Class	Carbon Steel with Cladding
11. Body Material	ASTM A105 or ASTM A216 Gr WCB
12. Disc Material	AISI 316 + Inconel 625 weld overlay (acc. item A.7.1.7.3)
13. Seat Material	RPTFE
14. Seal Ring	N/A
15. Stem Material	ASTM B637 (UNS N07718)
16. Stem Seal Material	PTFE
17. Operator Type	4" - 6" Lever 8" - 12" Gearbox
18. Additional Requirement	N/A
19. Product testing	FAT according A.9.3
20. Disc Coating	Full clad - Inconel 625 weld overlay on all wetted parts
21. Notes	N/A

Valve Code	VBO-300-2-D211
Specs	C11 C16
1. Valve Type	Butterfly, Lug type
2. Sealing Type	Soft
3. Valve Specification Level (VSL)	VSL-2
4. Disc & Seat Configuration	Double Offset
5. Standard	API 609 Category B
6. Size Range (NPS)	4" - 20"
7. End Connection	RF
8. Pressure Class	300
9. Temperature	-46°C to 150°C
10. Material Class	Duplex Steel
11. Body Material	ASTM A182 Gr F51 or ASTM A995 Gr 4A
12. Disc Material	Duplex (UNS S31803)
13. Seat Material	RPTFE
14. Seal Ring	N/A
15. Stem Material	ASTM A276 (UNS S31803)
16. Stem Seal Material	According manufacturer standard, fitted to service conditions
17. Operator Type	4" - 6" Lever 8" - 20" Gearbox
18. Additional Requirement	Dead-end Service per API 609.
19. Product testing	FAT according A.9.3
20. Disc Coating	N/A
21. Notes	Through holes drilled and tapped according to ASME B1.1.

Valve Code	VBO-300-2-D213
Specs	C16
1. Valve Type	Butterfly, Double Flanged (short pattern)
2. Sealing Type	Soft
3. Valve Specification Level (VSL)	VSL-2
4. Disc & Seat Configuration	Double Offset
5. Standard	API 609 Category B
6. Size Range (NPS)	24" - 32"
7. End Connection	RF
8. Pressure Class	300
9. Temperature	-46°C to 150°C
10. Material Class	Duplex Steel
11. Body Material	ASTM A182 Gr F51 or ASTM A995 Gr 4A
12. Disc Material	Duplex (UNS S31803)
13. Seat Material	RPTFE
14. Seal Ring	N/A
15. Stem Material	ASTM A276 (UNS S31803)
16. Stem Seal Material	According manufacturer standard, fitted to service conditions
17. Operator Type	Gearbox
18. Additional Requirement	Dead-end Service per API 609.
19. Product testing	FAT according A.9.3
20. Disc Coating	N/A
21. Notes	N/A

Valve Code	VBO-300-2-D251
Specs	C11 C16
1. Valve Type	Butterfly, Lug type
2. Sealing Type	Soft
3. Valve Specification Level (VSL)	VSL-2
4. Disc & Seat Configuration	Double Offset, fire tested
5. Standard	API 609 Category B
6. Size Range (NPS)	4" - 20"
7. End Connection	RF
8. Pressure Class	300
9. Temperature	-46°C to 150°C
10. Material Class	Duplex Steel
11. Body Material	ASTM A182 Gr F51 or ASTM A995 Gr 4A
12. Disc Material	Duplex (UNS S31803)
13. Seat Material	RPTFE
14. Seal Ring	N/A
15. Stem Material	ASTM A276 (UNS S31803)
16. Stem Seal Material	According manufacturer standard, fitted to service conditions
17. Operator Type	4" - 6" Lever 8" - 20" Gearbox
18. Additional Requirement	Fire Tested (acc. item A.6.1.4). Dead-end Service per API 609.
19. Product testing	FAT according A.9.3
20. Disc Coating	N/A
21. Notes	Through holes drilled and tapped according to ASME B1.1.

Valve Code	VBO-300-2-D253
Specs	C16
1. Valve Type	Butterfly, Double Flanged (short pattern)
2. Sealing Type	Soft
3. Valve Specification Level (VSL)	VSL-2
4. Disc & Seat Configuration	Double Offset, fire tested
5. Standard	API 609 Category B
6. Size Range (NPS)	24" - 32"
7. End Connection	RF
8. Pressure Class	300
9. Temperature	-46°C to 150°C
10. Material Class	Duplex Steel
11. Body Material	ASTM A182 Gr F51 or ASTM A995 Gr 4A
12. Disc Material	Duplex (UNS S31803)
13. Seat Material	RPTFE
14. Seal Ring	N/A
15. Stem Material	ASTM A276 (UNS S31803)
16. Stem Seal Material	According manufacturer standard, fitted to service conditions
17. Operator Type	Gearbox
18. Additional Requirement	Fire Tested (acc. item A.6.1.4). Dead-end Service per API 609.
19. Product testing	FAT according A.9.3
20. Disc Coating	N/A
21. Notes	Through holes drilled and tapped according to ASME B1.1.

Valve Code	VBO-300-2-S211
Specs	C3
1. Valve Type	Butterfly, Lug type
2. Sealing Type	Soft
3. Valve Specification Level (VSL)	VSL-2
4. Disc & Seat Configuration	Double Offset
5. Standard	API 609 Category B
6. Size Range (NPS)	3" - 20"
7. End Connection	RF
8. Pressure Class	300
9. Temperature	-46°C to 150°C
10. Material Class	Stainless Steel
11. Body Material	ASTM A182 Gr F316 or ASTM A351 Gr CF8M
12. Disc Material	AISI 316
13. Seat Material	RPTFE
14. Seal Ring	N/A
15. Stem Material	ASTM A564 Type 630 H1150 (UNS S17400)
16. Stem Seal Material	According manufacturer standard, fitted to service conditions
17. Operator Type	3" - 6" Lever 8" - 20" Gearbox
18. Additional Requirement	Dead-end Service per API 609.
19. Product testing	FAT according A.9.3
20. Disc Coating	N/A
21. Notes	N/A

Valve Code	VBO-300-2-S213
Specs	C3
1. Valve Type	Butterfly, Double Flanged (short pattern)
2. Sealing Type	Soft
3. Valve Specification Level (VSL)	VSL-2
4. Disc & Seat Configuration	Double Offset
5. Standard	API 609 Category B
6. Size Range (NPS)	24" - 30"
7. End Connection	RF
8. Pressure Class	300
9. Temperature	-46°C to 150°C
10. Material Class	Stainless Steel
11. Body Material	ASTM A182 Gr F316 or ASTM A351 Gr CF8M
12. Disc Material	AISI 316
13. Seat Material	RPTFE
14. Seal Ring	N/A
15. Stem Material	ASTM A564 Type 630 H1150 (UNS S17400)
16. Stem Seal Material	According manufacturer standard, fitted to service conditions
17. Operator Type	Gearbox
18. Additional Requirement	Dead-end Service per API 609.
19. Product testing	FAT according A.9.3
20. Disc Coating	N/A
21. Notes	N/A

Valve Code	VBO-300-2-S231
Specs	C3
1. Valve Type	Butterfly, Lug type
2. Sealing Type	Metal to Metal
3. Valve Specification Level (VSL)	VSL-2
4. Disc & Seat Configuration	Double Offset, metal-seated
5. Standard	API 609 Category B
6. Size Range (NPS)	3" - 20"
7. End Connection	RF
8. Pressure Class	300
9. Temperature	-100°C to 150°C
10. Material Class	Stainless Steel
11. Body Material	ASTM A182 Gr F316 or ASTM A351 Gr CF8M
12. Disc Material	AISI 316
13. Seat Material	AISI 316 + Metallic Coating (acc. item A.7.5.4.3.2)
14. Seal Ring	N/A
15. Stem Material	ASTM A276 (UNS S31600)
16. Stem Seal Material	According manufacturer standard, fitted to service conditions
17. Operator Type	3" - 6" Lever 8" - 20" Gearbox
18. Additional Requirement	Dead-end Service per API 609.
19. Product testing	FAT according A.9.3
20. Disc Coating	N/A
21. Notes	N/A

Valve Code	VBO-300-2-S233
Specs	C3
1. Valve Type	Butterfly, Double Flanged (short pattern)
2. Sealing Type	Metal to Metal
3. Valve Specification Level (VSL)	VSL-2
4. Disc & Seat Configuration	Double Offset, metal-seated
5. Standard	API 609 Category B
6. Size Range (NPS)	24" - 30"
7. End Connection	RF
8. Pressure Class	300
9. Temperature	-100°C to 150°C
10. Material Class	Stainless Steel
11. Body Material	ASTM A182 Gr F316 or ASTM A351 Gr CF8M
12. Disc Material	AISI 316
13. Seat Material	AISI 316 + Metallic Coating (acc. item A.7.5.4.3.2)
14. Seal Ring	N/A
15. Stem Material	ASTM A276 (UNS S31600)
16. Stem Seal Material	According manufacturer standard, fitted to service conditions
17. Operator Type	Gearbox
18. Additional Requirement	Dead-end Service per API 609.
19. Product testing	FAT according A.9.3
20. Disc Coating	N/A
21. Notes	N/A

Valve Code	VBO-300-2-U311
Specs	C23
1. Valve Type	Butterfly, Lug type
2. Sealing Type	Soft
3. Valve Specification Level (VSL)	VSL-2
4. Disc & Seat Configuration	Double Offset
5. Standard	API 609 Category B
6. Size Range (NPS)	4" - 20"
7. End Connection	RF
8. Pressure Class	300
9. Temperature	0°C to 90°C
10. Material Class	Uncommon Materials
11. Body Material	ASTM B148 (UNS C95800)
12. Disc Material	ASTM B148 (UNS C95800)
13. Seat Material	RPTFE
14. Seal Ring	N/A
15. Stem Material	ASTM B574 (UNS N10276)
16. Stem Seal Material	PTFE
17. Operator Type	4" - 6" Lever 8" - 20" Gearbox
18. Additional Requirement	Dead-end Service per API 609.
19. Product testing	FAT according A.9.3
20. Disc Coating	N/A
21. Notes	Through holes drilled and tapped according to ASME B1.1.

Valve Code	VBO-300-2-U313
Specs	C23
1. Valve Type	Butterfly, Double Flanged (short pattern)
2. Sealing Type	Soft
3. Valve Specification Level (VSL)	VSL-2
4. Disc & Seat Configuration	Double Offset
5. Standard	API 609 Category B
6. Size Range (NPS)	24" - 32"
7. End Connection	RF
8. Pressure Class	300
9. Temperature	0°C to 90°C
10. Material Class	Uncommon Materials
11. Body Material	ASTM B148 (UNS C95800)
12. Disc Material	ASTM B148 (UNS C95800)
13. Seat Material	RPTFE
14. Seal Ring	N/A
15. Stem Material	ASTM B574 (UNS N10276)
16. Stem Seal Material	PTFE
17. Operator Type	Gearbox
18. Additional Requirement	Dead-end Service per API 609.
19. Product testing	FAT according A.9.3
20. Disc Coating	N/A
21. Notes	N/A

Valve Code	VBO-300-3-C161
Specs	C10
1. Valve Type	Butterfly, Lug type
2. Sealing Type	Metal to Metal
3. Valve Specification Level (VSL)	VSL-3
4. Disc & Seat Configuration	Triple Offset, fire tested
5. Standard	API 609 Category B
6. Size Range (NPS)	3" - 20"
7. End Connection	ASME B16.5, RF
8. Pressure Class	300
9. Temperature	-29°C to 240°C
10. Material Class	Carbon Steel
11. Body Material	ASTM A105
12. Disc Material	AISI 316
13. Seat Material	AISI 316 + Metallic Coating (acc. item A.7.5.4.3.2)
14. Seal Ring	Graphite Laminated with AISI 316
15. Stem Material	ASTM A564 Type 630 H1150 (UNS S17400)
16. Stem Seal Material	Graphite Based Seal
17. Operator Type	Gearbox
18. Additional Requirement	Fire Tested (acc. item A.6.1.4). Dead-end Service per API 609.
19. Product testing	FAT according A.9.3
20. Disc Coating	N/A
21. Notes	Acceptance criteria for all HP/LP seat tests (Normative/Supplementary): ISO 5208 Rate A.



Valve Code	VBO-300-3-C163
Specs	C10
1. Valve Type	Butterfly, Double Flanged (short pattern)
2. Sealing Type	Metal to Metal
3. Valve Specification Level (VSL)	VSL-3
4. Disc & Seat Configuration	Triple Offset, fire tested
5. Standard	API 609 Category B
6. Size Range (NPS)	24" - 26"
7. End Connection	RF
8. Pressure Class	300
9. Temperature	-29°C to 240°C
10. Material Class	Carbon Steel
11. Body Material	ASTM A105
12. Disc Material	AISI 316
13. Seat Material	AISI 316 + Metallic Coating (acc. Item A.7.5.4.3.2)
14. Seal Ring	Graphite Laminated with AISI 316
15. Stem Material	ASTM A564 Type 630 H1150 (UNS S17400)
16. Stem Seal Material	Graphite Based Seal Material
17. Operator Type	Gearbox
18. Additional Requirement	Fire Tested (acc. item A.6.1.4). Dead-end Service per API 609.
19. Product testing	FAT according A.9.3
20. Disc Coating	N/A
21. Notes	Acceptance criteria for all HP/LP seat tests (Normative/Supplementary): ISO 5208 Rate A.

Valve Code	VBO-300-3-C261
Specs	C6
1. Valve Type	Butterfly, Lug type
2. Sealing Type	Metal to Metal
3. Valve Specification Level (VSL)	VSL-3
4. Disc & Seat Configuration	Triple Offset, fire tested
5. Standard	API 609 Category B
6. Size Range (NPS)	10" - 20"
7. End Connection	RF
8. Pressure Class	300
9. Temperature	-46°C to 240°C
10. Material Class	Low-Temperature Carbon Steel
11. Body Material	ASTM A350 Gr LF2 CL1
12. Disc Material	AISI 316
13. Seat Material	AISI 316 + Metallic Coating (acc. Item A.7.5.4.3.2)
14. Seal Ring	Graphite Laminated with AISI 316
15. Stem Material	ASTM A564 Type 630 H1150 (UNS S17400)
16. Stem Seal Material	Graphite Based Seal Material
17. Operator Type	Gearbox
18. Additional Requirement	Fire Tested (acc. item A.6.1.4). Dead-end Service per API 609.
19. Product testing	FAT according A.9.3
20. Disc Coating	N/A
21. Notes	Acceptance criteria for all HP/LP seat tests (Normative/Supplementary): ISO 5208 Rate A.

Valve Code	VBO-300-3-C263
Specs	C6
1. Valve Type	Butterfly, Double Flanged (short pattern)
2. Sealing Type	Metal to Metal
3. Valve Specification Level (VSL)	VSL-3
4. Disc & Seat Configuration	Triple Offset, fire tested
5. Standard	API 609 Category B
6. Size Range (NPS)	24" - 30"
7. End Connection	RF
8. Pressure Class	300
9. Temperature	-46°C to 240°C
10. Material Class	Low-Temperature Carbon Steel
11. Body Material	ASTM A350 Gr LF2 CL1
12. Disc Material	AISI 316
13. Seat Material	AISI 316 + Metallic Coating (acc. Item A.7.5.4.3.2)
14. Seal Ring	Graphite Laminated with AISI 316
15. Stem Material	ASTM A564 Type 630 H1150 (UNS S17400)
16. Stem Seal Material	Graphite Based Seal Material
17. Operator Type	Gearbox
18. Additional Requirement	Fire Tested (acc. item A.6.1.4). Dead-end Service per API 609.
19. Product testing	FAT according A.9.3
20. Disc Coating	N/A
21. Notes	Acceptance criteria for all HP/LP seat tests (Normative/Supplementary): ISO 5208 Rate A.

Valve Code	VBO-300-3-D261
Specs	C11
1. Valve Type	Butterfly, Lug type
2. Sealing Type	Metal to Metal
3. Valve Specification Level (VSL)	VSL-3
4. Disc & Seat Configuration	Triple Offset, fire tested
5. Standard	API 609 Category B
6. Size Range (NPS)	6" - 20"
7. End Connection	RF
8. Pressure Class	300
9. Temperature	-46°C to 150°C
10. Material Class	Duplex Steel
11. Body Material	ASTM A182 Gr F51
12. Disc Material	Duplex (UNS S31803)
13. Seat Material	Duplex (UNS S31803) + Metallic Coating (acc. Item A.7.5.4.3.2)
14. Seal Ring	Graphite Laminated with Duplex (UNS S31803)
15. Stem Material	ASTM A276 (UNS S31803)
16. Stem Seal Material	Graphite Based Seal Material
17. Operator Type	Gearbox
18. Additional Requirement	Fire Tested (acc. item A.6.1.4). Dead-end Service per API 609.
19. Product testing	FAT according A.9.3
20. Disc Coating	N/A
21. Notes	Acceptance criteria for all HP/LP seat tests (Normative/Supplementary): ISO 5208 Rate A.

Valve Code	VBO-600-3-D261
Specs	E16
1. Valve Type	Butterfly, Lug type
2. Sealing Type	Metal to Metal
3. Valve Specification Level (VSL)	VSL-3
4. Disc & Seat Configuration	Triple Offset, fire tested
5. Standard	API 609 Category B
6. Size Range (NPS)	6" - 16"
7. End Connection	RF
8. Pressure Class	600
9. Temperature	-46°C to 150°C
10. Material Class	Duplex Steel
11. Body Material	ASTM A182 Gr F51
12. Disc Material	Duplex (UNS S31803)
13. Seat Material	Duplex (UNS S31803) + Metallic Coating (acc. Item A.7.5.4.3.2)
14. Seal Ring	Graphite Laminated with Duplex (UNS S31803)
15. Stem Material	ASTM A276 (UNS S31803)
16. Stem Seal Material	Graphite Based Seal Material
17. Operator Type	Gearbox
18. Additional Requirement	Fire Tested (acc. item A.6.1.4). Dead-end Service per API 609.
19. Product testing	FAT according A.9.3
20. Disc Coating	N/A
21. Notes	Acceptance criteria for all HP/LP seat tests (Normative/Supplementary): ISO 5208 Rate A.

Valve Code	VBO-600-3-S261
Specs	E3
1. Valve Type	Butterfly, Lug type
2. Sealing Type	Metal to Metal
3. Valve Specification Level (VSL)	VSL-3
4. Disc & Seat Configuration	Triple Offset, fire tested
5. Standard	API 609 Category B
6. Size Range (NPS)	6" - 20"
7. End Connection	RF
8. Pressure Class	600
9. Temperature	-100°C to 345°C
10. Material Class	Stainless Steel
11. Body Material	ASTM A182 Gr F316
12. Disc Material	AISI 316
13. Seat Material	AISI 316 + Metallic Coating (acc. Item A.7.5.4.3.2)
14. Seal Ring	Graphite Laminated with AISI 316
15. Stem Material	ASTM A276 (UNS S31600)
16. Stem Seal Material	Graphite Based Seal Material
17. Operator Type	Gearbox
18. Additional Requirement	Fire Tested (acc. item A.6.1.4). Dead-end Service per API 609.
19. Product testing	FAT according A.9.3
20. Disc Coating	N/A
21. Notes	Acceptance criteria for all HP/LP seat tests (Normative/Supplementary): ISO 5208 Rate A.

Valve Code	VBO-600-3-S263
Specs	E3
1. Valve Type	Butterfly, Double Flanged (short pattern)
2. Sealing Type	Metal to Metal
3. Valve Specification Level (VSL)	VSL-3
4. Disc & Seat Configuration	Triple Offset, fire tested
5. Standard	API 609 Category B
6. Size Range (NPS)	24" - 32"
7. End Connection	RF
8. Pressure Class	600
9. Temperature	-100°C to 345°C
10. Material Class	Stainless Steel
11. Body Material	ASTM A182 Gr F316
12. Disc Material	AISI 316
13. Seat Material	AISI 316 + Metallic Coating (acc. Item A.7.5.4.3.2)
14. Seal Ring	Graphite Laminated with AISI 316
15. Stem Material	ASTM A276 (UNS S31600)
16. Stem Seal Material	Graphite Based Seal Material
17. Operator Type	Gearbox
18. Additional Requirement	Fire Tested (acc. item A.6.1.4). Dead-end Service per API 609.
19. Product testing	FAT according A.9.3
20. Disc Coating	N/A
21. Notes	Acceptance criteria for all HP/LP seat tests (Normative/Supplementary): ISO 5208 Rate A.

Valve Code	VBO-900-3-C267
Specs	F6
1. Valve Type	Butterfly, Lug type
2. Sealing Type	Metal to Metal
3. Valve Specification Level (VSL)	VSL-3
4. Disc & Seat Configuration	Triple Offset, fire tested
5. Standard	API 609 Category B
6. Size Range (NPS)	6" - 20"
7. End Connection	RTJ
8. Pressure Class	900
9. Temperature	-46°C to 340°C
10. Material Class	Low-Temperature Carbon Steel
11. Body Material	ASTM A350 Gr LF2 CL1
12. Disc Material	AISI 316
13. Seat Material	AISI 316 + Metallic Coating (acc. Item A.7.5.4.3.2)
14. Seal Ring	Graphite Laminated with AISI 316
15. Stem Material	ASTM A564 Type 630 H1150 (UNS S17400)
16. Stem Seal Material	Graphite Based Seal Material
17. Operator Type	Gearbox
18. Additional Requirement	Fire Tested (acc. item A.6.1.4). Dead-end Service per API 609.
19. Product testing	FAT according A.9.3
20. Disc Coating	N/A
21. Notes	Acceptance criteria for all HP/LP seat tests (Normative/Supplementary): ISO 5208 Rate A.







Valve Code	VAG-5000-1-S202
Specs	G3 G10
1. Valve Type	Needle
2. Sealing Type	Metal to Metal
3. Valve Specification Level (VSL)	VSL-1
4. Obturator Type	Rising Plug
5. Standard	ASME 16.34 LTD
6. Size Range (NPS)	½" - 1 ½"
7. End Connection	socket weld ends ASME B16.11
8. Pressure Class	max. pressure 5000 psi
9. Temperature	-100°C to 400°C
10. Material Class	Stainless Steel
11. Body Material	ASTM A182 Gr F316/316L
12. Obturator Material	Stainless Steel with hardness superior to seat
13. Seat Material	ASTM A 182 Gr F316L
14. Stem Seal Material	Graphoil
15. Body Construction	N/A
16. Additional Requirement	N/A
17. Operator Type	Rising Handwheel
18. Stem Design	rising stem, inside screw stem; Stem swivel
19. Product testing	FAT according A.9.3
20. Coating or Cladding	N/A
21. Notes	N/A

Valve Code	VAG-5000-1-S2F1
Specs	G3 G10
1. Valve Type	Needle
2. Sealing Type	Metal to Metal
3. Valve Specification Level (VSL)	VSL-1
4. Obturator Type	Rising Plug
5. Standard	ASME 16.34 LTD
6. Size Range (NPS)	½" - 1 ½"
7. End Connection	socket weld ends ASME B16.11
8. Pressure Class	max. pressure 5000 psi
9. Temperature	-100°C to 200°C
10. Material Class	Stainless Steel
11. Body Material	ASTM A182 Gr F316/316L
12. Obturator Material	Stainless Steel with hardness superior to seat
13. Seat Material	ASTM A 182 Gr F316L
14. Stem Seal Material	PTFE
15. Body Construction	N/A
16. Additional Requirement	Fugitive Emission (acc. item A.6.1.6)
17. Operator Type	Rising Handwheel
18. Stem Design	rising stem, inside screw stem; Stem swivel
19. Product testing	FAT according A.9.3
20. Coating or Cladding	N/A
21. Notes	N/A

Valve Code	VAG-5000-1-S2F2
Specs	G3 G10
1. Valve Type	Needle
2. Sealing Type	Metal to Metal
3. Valve Specification Level (VSL)	VSL-1
4. Obturator Type	Rising Plug
5. Standard	ASME 16.34 LTD
6. Size Range (NPS)	½" - 1 ½"
7. End Connection	socket weld ends ASME B16.11
8. Pressure Class	max. pressure 5000 psi
9. Temperature	-100°C to 400°C
10. Material Class	Stainless Steel
11. Body Material	ASTM A182 Gr F316/316L
12. Obturator Material	Stainless Steel with hardness superior to seat
13. Seat Material	ASTM A 182 Gr F316L
14. Stem Seal Material	Graphoil
15. Body Construction	N/A
16. Additional Requirement	Fugitive Emission (acc. item A.6.1.6)
17. Operator Type	Rising Handwheel
18. Stem Design	rising stem, inside screw stem; Stem swivel
19. Product testing	FAT according A.9.3
20. Coating or Cladding	N/A
21. Notes	N/A

Valve Code	VAG-6000-1-D302
Specs	H12
1. Valve Type	Needle
2. Sealing Type	Metal to Metal
3. Valve Specification Level (VSL)	VSL-1
4. Obturator Type	Rising Plug
5. Standard	ASME 16.34 LTD
6. Size Range (NPS)	1" - 1 ½"
7. End Connection	butt weld ASME B16.25
8. Pressure Class	max. pressure 6000 psi
9. Temperature	-50°C to 150°C
10. Material Class	Duplex Steel
11. Body Material	ASTM A182 Gr F55
12. Obturator Material	ASTM A182 Gr F55
13. Seat Material	ASTM A182 Gr F55
14. Stem Seal Material	Graphoil
15. Body Construction	N/A
16. Additional Requirement	N/A
17. Operator Type	Rising Handwheel
18. Stem Design	rising stem, inside screw stem; Stem swivel
19. Product testing	FAT according A.9.3
20. Coating or Cladding	N/A
21. Notes	N/A

Valve Code	VAG-6000-1-D3F2
Specs	H12
1. Valve Type	Needle
2. Sealing Type	Metal to Metal
3. Valve Specification Level (VSL)	VSL-1
4. Obturator Type	Rising Plug
5. Standard	ASME 16.34 LTD
6. Size Range (NPS)	1" - 1 ½"
7. End Connection	butt weld ASME B16.25
8. Pressure Class	max. pressure 6000 psi
9. Temperature	-50°C to 150°C
10. Material Class	Duplex Steel
11. Body Material	ASTM A182 Gr F55
12. Obturator Material	ASTM A182 Gr F55
13. Seat Material	ASTM A182 Gr F55
14. Stem Seal Material	Graphoil
15. Body Construction	N/A
16. Additional Requirement	Fugitive Emission (acc. item A.6.1.6)
17. Operator Type	Rising Handwheel
18. Stem Design	rising stem, inside screw stem; Stem swivel
19. Product testing	FAT according A.9.3
20. Coating or Cladding	N/A
21. Notes	N/A

Valve Code	VAG-6000-1-N102
Specs	H30
1. Valve Type	Needle
2. Sealing Type	Metal to Metal
3. Valve Specification Level (VSL)	VSL-1
4. Obturator Type	Rising Plug
5. Standard	ASME 16.34 LTD
6. Size Range (NPS)	1" - 1 ½"
7. End Connection	butt weld ASME B16.25
8. Pressure Class	max. pressure 6000 psi
9. Temperature	-100°C to 400°C
10. Material Class	Nickel Alloys
11. Body Material	ASTM B564 (UNS N06625)
12. Obturator Material	ASTM B564 (UNS N06625)
13. Seat Material	ASTM B564 (UNS N06625)
14. Stem Seal Material	Graphoil
15. Body Construction	N/A
16. Additional Requirement	N/A
17. Operator Type	Rising Handwheel
18. Stem Design	rising stem, inside screw stem; Stem swivel
19. Product testing	FAT according A.9.3
20. Coating or Cladding	N/A
21. Notes	N/A

Valve Code	VAG-6000-1-N1F2
Specs	H30
1. Valve Type	Needle
2. Sealing Type	Metal to Metal
3. Valve Specification Level (VSL)	VSL-1
4. Obturator Type	Rising Plug
5. Standard	ASME 16.34 LTD
6. Size Range (NPS)	1" - 1 ½"
7. End Connection	butt weld ASME B16.25
8. Pressure Class	max. pressure 6000 psi
9. Temperature	-100°C to 400°C
10. Material Class	Nickel Alloys
11. Body Material	ASTM B564 (UNS N06625)
12. Obturator Material	ASTM B564 (UNS N06625)
13. Seat Material	ASTM B564 (UNS N06625)
14. Stem Seal Material	Graphoil
15. Body Construction	N/A
16. Additional Requirement	Fugitive Emission (acc. item A.6.1.6)
17. Operator Type	Rising Handwheel
18. Stem Design	rising stem, inside screw stem; Stem swivel
19. Product testing	FAT according A.9.3
20. Coating or Cladding	N/A
21. Notes	N/A

Valve Code	VAG-6000-1-S201
Specs	H3
1. Valve Type	Needle
2. Sealing Type	Metal to Metal
3. Valve Specification Level (VSL)	VSL-1
4. Obturator Type	Rising Plug
5. Standard	ASME 16.34 LTD
6. Size Range (NPS)	1" - 1 ½"
7. End Connection	butt weld ASME B16.25
8. Pressure Class	max. pressure 6000 psi
9. Temperature	-100°C to 200°C
10. Material Class	Stainless Steel
11. Body Material	ASTM A182 Gr F316/316L
12. Obturator Material	Stainless Steel with hardness superior to seat
13. Seat Material	ASTM A 182 Gr F316L
14. Stem Seal Material	PTFE
15. Body Construction	N/A
16. Additional Requirement	N/A
17. Operator Type	Rising Handwheel
18. Stem Design	rising stem, inside screw stem; Stem swivel
19. Product testing	FAT according A.9.3
20. Coating or Cladding	N/A
21. Notes	N/A

Valve Code	VAG-6000-1-S202
Specs	H3
1. Valve Type	Needle
2. Sealing Type	Metal to Metal
3. Valve Specification Level (VSL)	VSL-1
4. Obturator Type	Rising Plug
5. Standard	ASME 16.34 LTD
6. Size Range (NPS)	1" - 1 ½"
7. End Connection	butt weld ASME B16.25
8. Pressure Class	max. pressure 6000 psi
9. Temperature	-100°C to 400°C
10. Material Class	Stainless Steel
11. Body Material	ASTM A182 Gr F316/316L
12. Obturator Material	Stainless Steel with hardness superior to seat
13. Seat Material	ASTM A 182 Gr F316L
14. Stem Seal Material	Graphoil
15. Body Construction	N/A
16. Additional Requirement	N/A
17. Operator Type	Rising Handwheel
18. Stem Design	rising stem, inside screw stem; Stem swivel
19. Product testing	FAT according A.9.3
20. Coating or Cladding	N/A
21. Notes	N/A

Valve Code	VAG-6000-1-S2F1
Specs	H3
1. Valve Type	Needle
2. Sealing Type	Metal to Metal
3. Valve Specification Level (VSL)	VSL-1
4. Obturator Type	Rising Plug
5. Standard	ASME 16.34 LTD
6. Size Range (NPS)	1" - 1 ½"
7. End Connection	butt weld ASME B16.25
8. Pressure Class	max. pressure 6000 psi
9. Temperature	-100°C to 200°C
10. Material Class	Stainless Steel
11. Body Material	ASTM A182 Gr F316/316L
12. Obturator Material	Stainless Steel with hardness superior to seat
13. Seat Material	ASTM A 182 Gr F316L
14. Stem Seal Material	PTFE
15. Body Construction	N/A
16. Additional Requirement	Fugitive Emission (acc. item A.6.1.6)
17. Operator Type	Rising Handwheel
18. Stem Design	rising stem, inside screw stem; Stem swivel
19. Product testing	FAT according A.9.3
20. Coating or Cladding	N/A
21. Notes	N/A

Valve Code	VAG-6000-1-S2F2
Specs	H3
1. Valve Type	Needle
2. Sealing Type	Metal to Metal
3. Valve Specification Level (VSL)	VSL-1
4. Obturator Type	Rising Plug
5. Standard	ASME 16.34 LTD
6. Size Range (NPS)	1" - 1 ½"
7. End Connection	butt weld ASME B16.25
8. Pressure Class	max. pressure 6000 psi
9. Temperature	-100°C to 400°C
10. Material Class	Stainless Steel
11. Body Material	ASTM A182 Gr F316/316L
12. Obturator Material	Stainless Steel with hardness superior to seat
13. Seat Material	ASTM A 182 Gr F316L
14. Stem Seal Material	Graphoil
15. Body Construction	N/A
16. Additional Requirement	Fugitive Emission (acc. item A.6.1.6)
17. Operator Type	Rising Handwheel
18. Stem Design	rising stem, inside screw stem; Stem swivel
19. Product testing	FAT according A.9.3
20. Coating or Cladding	N/A
21. Notes	N/A



## A.12.9 DIAPHRAGM VALVES

Valve Code	VDI-300-2-U301
Specs	B7
1. Valve Type	Diaphragm
2. Sealing Type	Soft
3. Valve Specification Level (VSL)	VSL-2
4. Obturator Type	Diaphragm
5. Standard	According to Manufacturer Standard
6. Size Range (NPS)	1 1/2" - 12"
7. End Connection	Flanged ASME B16.5 (CL150), RF
8. Pressure Class	max. press 300 psig
9. Temperature	0°C to 80°C
10. Material Class	Uncommon Materials
11. Body Material	ASTM B148 (UNS C95800)
12. Diaphragm Material	NBR
13. Stem Material	ASTM B150 (UNS C63200)
14. Spring Material	UNS N07750
15. Additional Requirement	Fire safe design (acc. item A.6.1.5)
16. Body Construction	According to Manufacturer Standard
16. Stem Seal Material	N/A
17. Product Testing	FAT according A.9.3
18. Cladding or Coating	N/A
19. Notes	N/A



## A.12.10 AXIAL VALVES

Valve Code	VAX-1500-3-S2F1
Specs	G3
Valve Code	VAX-2510-3-D3F1
Specs	H12
Valve Code	VAX-2510-4-D2F1
Specs	H16
Valve Code	VAX-2510-4-D3F1
Specs	H12

Valve Code	VAX-2510-3-D201
Specs	H16
Valve Code	VAX-2510-3-S2F1
Specs	H3
Valve Code	VAX-2510-4-D2F2
Specs	H16
Valve Code	VAX-2510-4-D3F2
Specs	H12

Valve Code	VAX-2510-3-D2F1
Specs	H16
Valve Code	VAX-2510-4-D201
Specs	H16
Valve Code	VAX-2510-4-D301
Specs	H12 H30

Valve Code	VAX-2510-3-D301
Specs	H12 H30
Valve Code	VAX-2510-4-D202
Specs	H16
Valve Code	VAX-2510-4-D302
Specs	H12 H30

A.12.11 BRONZE VALVES

Valve Code Specs	VAN-150-1-U101 B7
1. Valve Type	Angular Valve
2. Sealing Type	Metal to Metal
3. Valve Specification Level (VSL)	VSL-1
4. Obturator Type	Bevelled Disc
5. Standard	MSS SP-80
6. Size Range (NPS)	2 ½"
7. End Connection	Inlet: flange acc. B16.24 - Outlet: Male-threaded acc. NFPA 1693 2,5-7,5 NH
8. Pressure Class	150
9. Temperature	0°C to 75°C
10. Material Class	Uncommon Materials
11. Body Material	ASTM B62 (UNS C83600)
12. TRIM Material	N/A
13. Gate Material	ASTM B62 (UNS C83600)
14. Seat Material	ASTM B62 (UNS C83600)
15. Stem Material	According manufacturer standard, fitted to service conditions
16. Stem Seal Material	PTFE
17. Operator Type	Rising Handwheel
18. Additional Requirement	N/A
19. Body Construction	screwed bonnet
20. Product Testing	FAT according A.9.3
21. Cladding or Coating	N/A
22. Stem Design	inside screw stem

Valve Code Specs	VGA-150-1-U102 B14
1. Valve Type	Gate Valve
2. Sealing Type	Metal to Metal
3. Valve Specification Level (VSL)	VSL-1
4. Obturator Type	Solid wedge
5. Standard	MSS SP-80
6. Size Range (NPS)	1" - 3"
7. End Connection	Flat Face, ASME B16.24
8. Pressure Class	150
9. Temperature	-29°C to 75°C
10. Material Class	Uncommon Materials
11. Body Material	ASTM B62 (UNS C83600)
12. TRIM Material	N/A
13. Gate Material	ASTM B62 (UNS C83600)
14. Seat Material	ASTM B62 (UNS C83600)
15. Stem Material	ASTM B62 (UNS C83600)
16. Stem Seal Material	According manufacturer standard, fitted to service conditions
17. Operator Type	non rising handwheel
18. Additional Requirement	N/A
19. Body Construction	union bonnet
20. Product Testing	FAT according A.9.3
21. Cladding or Coating	N/A
22. Stem Design	inside screw stem

Valve Code Specs	VGA-200-1-U101 B7
1. Valve Type	Gate Valve
2. Sealing Type	Metal to Metal
3. Valve Specification Level (VSL)	VSL-1
4. Obturator Type	Solid wedge
5. Standard	MSS SP-80
6. Size Range (NPS)	½" - 3"
7. End Connection	Screwed ends, ASME B1.20.1
8. Pressure Class	max. press 200 psig
9. Temperature	-29°C to 75°C
10. Material Class	Uncommon Materials
11. Body Material	ASTM B61 (UNS C92200)
12. TRIM Material	N/A
13. Gate Material	ASTM B61 (UNS C92200)
14. Seat Material	ASTM B61 (UNS C92200)
15. Stem Material	ASTM B61 (UNS C92200)
16. Stem Seal Material	According manufacturer standard, fitted to service conditions
17. Operator Type	non rising handwheel
18. Additional Requirement	N/A
19. Body Construction	union bonnet
20. Product Testing	FAT according A.9.3
21. Cladding or Coating	N/A
22. Stem Design	inside screw stem

Valve Code Specs	VGL-150-1-U101 B7
1. Valve Type	Globe Valve
2. Sealing Type	Metal to Metal
3. Valve Specification Level (VSL)	VSL-1
4. Obturator Type	Bevelled Disc
5. Standard	MSS SP-80
6. Size Range (NPS)	½" - 1 ½"
7. End Connection	Screwed ends, ASME B1.20.1
8. Pressure Class	150
9. Temperature	0°C to 75°C
10. Material Class	Uncommon Materials
11. Body Material	ASTM B62 (UNS C83600)
12. TRIM Material	N/A
13. Gate Material	ASTM B62 (UNS C83600)
14. Seat Material	ASTM B62 (UNS C83600)
15. Stem Material	ASTM B62 (UNS C83600)
16. Stem Seal Material	According manufacturer standard, fitted to service conditions
17. Operator Type	Rising Handwheel
18. Additional Requirement	N/A
19. Body Construction	union bonnet
20. Product Testing	FAT according A.9.3
21. Cladding or Coating	N/A
22. Stem Design	inside screw stem

A.12.12 PLASTIC VALVES

Valve Code	VES-150-1-U403
Specs	B22 B23
1. Valve Type	Ball Valve
2. Sealing Type	Soft
3. Valve Specification Level (VSL)	VSL-1
4. Standard	Manufacturer standard
5. Size Range (NPS)	4" - 44"
6. End Connection	Flanged ASME B16.1, FF
7. Pressure Class	max. press 150 psig
8. Temperature	10°C to 70°C
9. Material Class	Uncommon Materials
10. Body Material	glass-fiber reinforced vinyl ester
11. Obturator Material	Glass fiber reinforced vinyl ester resin
12. Seat Material	Glass fiber reinforced vinyl ester
13. Stem Material	According manufacturer standard, fitted to service conditions
14. Operator Type	Lever
15. Bore Type	Full Bore
16. Body Construction	N/A
17. Product Testing	FAT according manufacturer standard
18. Notes	Any metallic parts used in valve construction and in contact with process fluid shall be made of ASTM B564 (UNS N10276), For use with temperatures higher than ambient, see item A.7.6.2

Valve Code	VES-150-1-U404
Specs	B26
1. Valve Type	Ball Valve
2. Sealing Type	Soft
3. Valve Specification Level (VSL)	VSL-1
4. Standard	Manufacturer standard
5. Size Range (NPS)	4" - 10"
6. End Connection	Flanged ASME B16.1, FF
7. Pressure Class	max. press 150 psig
8. Temperature	10°C to 90°C
9. Material Class	Uncommon Materials
10. Body Material	glass-fiber reinforced vinyl ester
11. Obturator Material	Glass Fiber reinforced novolac epoxy
12. Seat Material	Glass fiber reinforced vinyl ester
13. Stem Material	According manufacturer standard, fitted to service conditions
14. Operator Type	Lever
15. Bore Type	Full Bore
16. Body Construction	N/A
17. Product Testing	FAT according manufacturer standard
18. Notes	Any metallic parts used in valve construction and in contact with process fluid shall be made of ASTM B564 (UNS N10276), For use with temperatures higher than ambient, see item A.7.6.2

Valve Code	VES-250-1-U403
Specs	B22 B23
1. Valve Type	Ball Valve
2. Sealing Type	Soft
3. Valve Specification Level (VSL)	VSL-1
4. Standard	Manufacturer standard
5. Size Range (NPS)	2" - 3"
6. End Connection	Flanged ASME B16.1, FF
7. Pressure Class	max. press 250 psig
8. Temperature	10°C to 70°C
9. Material Class	Uncommon Materials
10. Body Material	glass-fiber reinforced vinyl ester
11. Obturator Material	Glass fiber reinforced vinyl ester resin
12. Seat Material	Glass fiber reinforced vinyl ester
13. Stem Material	According manufacturer standard, fitted to service conditions
14. Operator Type	Lever
15. Bore Type	Full Bore
16. Body Construction	N/A
17. Product Testing	FAT according manufacturer standard
18. Notes	Any metallic parts used in valve construction and in contact with process fluid shall be made of ASTM B564 (UNS N10276), For use with temperatures higher than ambient, see item A.7.6.2

Valve Code	VES-250-1-U404
Specs	B26
1. Valve Type	Ball Valve
2. Sealing Type	Soft
3. Valve Specification Level (VSL)	VSL-1
4. Standard	Manufacturer standard
5. Size Range (NPS)	2" - 3"
6. End Connection	Flanged ASME B16.1, FF
7. Pressure Class	max. press 250 psig
8. Temperature	10°C to 90°C
9. Material Class	Uncommon Materials
10. Body Material	glass-fiber reinforced vinyl ester
11. Obturator Material	Glass Fiber reinforced novolac epoxy
12. Seat Material	Glass fiber reinforced vinyl ester
13. Stem Material	According manufacturer standard, fitted to service conditions
14. Operator Type	Lever
15. Bore Type	Full Bore
16. Body Construction	N/A
17. Product Testing	FAT according manufacturer standard
18. Notes	Any metallic parts used in valve construction and in contact with process fluid shall be made of ASTM B564 (UNS N10276), For use with temperatures higher than ambient, see item A.7.6.2

Valve Code	VES-275-1-U403
Specs	B22 B23
1. Valve Type	Ball Valve
2. Sealing Type	Soft
3. Valve Specification Level (VSL)	VSL-1
4. Standard	Manufacturer standard
5. Size Range (NPS)	1" - 1 1/2"
6. End Connection	Flanged ASME B16.1, FF
7. Pressure Class	max. press 275 psig
8. Temperature	10°C to 70°C
9. Material Class	Uncommon Materials
10. Body Material	glass-fiber reinforced vinyl ester
11. Obturator Material	Glass fiber reinforced vinyl ester resin
12. Seat Material	Glass fiber reinforced vinyl ester
13. Stem Material	According manufacturer standard, fitted to service conditions
14. Operator Type	Lever
15. Bore Type	Full Bore
16. Body Construction	N/A
17. Product Testing	FAT according manufacturer standard
18. Notes	Any metallic parts used in valve construction and in contact with process fluid shall be made of ASTM B564 (UNS N10276), For use with temperatures higher than ambient, see item A.7.6.2

Valve Code	VES-275-1-U404
Specs	B26
1. Valve Type	Ball Valve
2. Sealing Type	Soft
3. Valve Specification Level (VSL)	VSL-1
4. Standard	Manufacturer standard
5. Size Range (NPS)	1" - 1 1/2"
6. End Connection	Flanged ASME B16.1, FF
7. Pressure Class	max. press 275 psig
8. Temperature	10°C to 90°C
9. Material Class	Uncommon Materials
10. Body Material	glass-fiber reinforced vinyl ester
11. Obturator Material	Glass Fiber reinforced novolac epoxy
12. Seat Material	Glass fiber reinforced vinyl ester
13. Stem Material	According manufacturer standard, fitted to service conditions
14. Operator Type	Lever
15. Bore Type	Full Bore
16. Body Construction	N/A
17. Product Testing	FAT according manufacturer standard
18. Notes	Any metallic parts used in valve construction and in contact with process fluid shall be made of ASTM B564 (UNS N10276), For use with temperatures higher than ambient, see item A.7.6.2



A.12.13 INSTRUMENTATION VALVES

Valve Code	VAGI-6000-1-S201
Specs	T60A
1. Valve Type	Needle valve for instrumentation
2. Sealing Type	Soft
3. Valve Specification Level (VSL)	VSL-1
4. Obturator Type	Obturator not solid with stem
5. Valve Standard	Manufacturer Standard
6. Size Range (NPS)	¼" - 1 ½"
7. End Connection	OD tube connection
8. Pressure Class	max. pressure 6000 psi
9. Temperature	0°C to 200°C
10. Material Class	Stainless Steel
11. Body Material	ASTM A182 Gr F316
12. Obturator Material	Stainless Steel with hardness superior to seat
13. Seat Material	ASTM A276 (UNS S31600)
14. Stem Seal	PTFE
15. Operator Type	Lever
16. Stem Construction	inside screw stem
17. Bonnet Construction	union bonnet
18. Product Testing	FAT according manufacturer standard
19. Notes	Device or constructive criterion that avoids accidental disassembly of valve TRIM

Valve Code	VAGI-6000-1-S202
Specs	T60A
1. Valve Type	Needle valve for instrumentation
2. Sealing Type	Soft
3. Valve Specification Level (VSL)	VSL-1
4. Obturator Type	Obturator not solid with stem
5. Valve Standard	Manufacturer Standard
6. Size Range (NPS)	¼" - 1 ½"
7. End Connection	NPT Female
8. Pressure Class	max. pressure 6000 psi
9. Temperature	0°C to 200°C
10. Material Class	Stainless Steel
11. Body Material	ASTM A182 Gr F316
12. Obturator Material	Stainless Steel with hardness superior to seat
13. Seat Material	ASTM A276 (UNS S31600)
14. Stem Seal	PTFE
15. Operator Type	Lever
16. Stem Construction	inside screw stem
17. Bonnet Construction	union bonnet
18. Product Testing	FAT according manufacturer standard
19. Notes	Device or constructive criterion that avoids accidental disassembly of valve TRIM

Valve Code	VDEI-6000-1-S201
Specs	T60A
1. Valve Type	Double Ball valve for instrumentation
2. Sealing Type	Soft
3. Valve Specification Level (VSL)	VSL-1
4. Obturator Type	Floating Ball
5. Valve Standard	Manufacturer Standard
6. Size Range (NPS)	¼" - 1 ½"
7. End Connection	OD tube connection
8. Pressure Class	max. pressure 6000 psi
9. Temperature	0°C to 200°C
10. Material Class	Stainless Steel
11. Body Material	ASTM A182 Gr F316
12. Obturator Material	AISI 316
13. Seat Material	ASTM A276 (UNS S31600)
14. Stem Seal	PTFE
15. Operator Type	Lever
16. Stem Construction	inside screw stem
17. Bonnet Construction	Integral bonnet
18. Product Testing	FAT according manufacturer standard
19. Notes	Needle valve between balls for cavity-pressure relief. Device or constructive criterion that avoids accidental disassembly of valve TRIM

Valve Code	VESI-6000-1-S201
Specs	T60A
1. Valve Type	Ball valve for instrumentation
2. Sealing Type	Soft
3. Valve Specification Level (VSL)	VSL-1
4. Obturator Type	Floating Ball
5. Valve Standard	Manufacturer Standard
6. Size Range (NPS)	¼" - 1 ½"
7. End Connection	OD tube connection
8. Pressure Class	max. pressure 6000 psi
9. Temperature	0°C to 200°C
10. Material Class	Stainless Steel
11. Body Material	ASTM A182 Gr F316
12. Obturator Material	AISI 316
13. Seat Material	ASTM A276 (UNS S31600)
14. Stem Seal	PTFE
15. Operator Type	Lever
16. Stem Construction	inside screw stem
17. Bonnet Construction	Integral bonnet
18. Product Testing	FAT according manufacturer standard
19. Notes	Device or constructive criterion that avoids accidental disassembly of valve TRIM

Valve Code	VESI-6000-1-S202
Specs	T60A
1. Valve Type	Ball valve for instrumentation
2. Sealing Type	Soft
3. Valve Specification Level (VSL)	VSL-1
4. Obturator Type	Floating Ball
5. Valve Standard	Manufacturer Standard
6. Size Range (NPS)	¼" - 1 ½"
7. End Connection	NPT Female
8. Pressure Class	max. pressure 6000 psi
9. Temperature	0°C to 200°C
10. Material Class	Stainless Steel
11. Body Material	ASTM A182 Gr F316
12. Obturator Material	AISI 316
13. Seat Material	ASTM A276 (UNS S31600)
14. Stem Seal	PTFE
15. Operator Type	Lever
16. Stem Construction	inside screw stem
17. Bonnet Construction	Integral bonnet
18. Product Testing	FAT according manufacturer standard
19. Notes	Device or constructive criterion that avoids accidental disassembly of valve TRIM

Valve Code	VREI-6000-1-S201
Specs	T60A
1. Valve Type	Check valve for instrumentation
2. Sealing Type	Metal to Metal
3. Valve Specification Level (VSL)	VSL-1
4. Obturator Type	Manufacturer Standard
5. Valve Standard	Manufacturer Standard
6. Size Range (NPS)	¼" - 1 ½"
7. End Connection	OD tube connection
8. Pressure Class	max. pressure 6000 psi
9. Temperature	0°C to 90°C
10. Material Class	Stainless Steel
11. Body Material	ASTM A182 Gr F316
12. obturator Material	AISI 316
13. Seat Material	N/A
14. Stem Seal	N/A
15. Operator Type	Not Applicable
16. Stem Construction	Not Applicable
17. Bonnet Construction	Not Applicable
18. Product Testing	FAT according manufacturer standard
19. Notes	Seal material shall be acc. "Group B" Annex A item A.7.1.5.6. Spring material acc. Manufacturer Standard.

Valve Code	VREI-6000-1-S202
Specs	T60A
1. Valve Type	Check valve for instrumentation
2. Sealing Type	Metal to Metal
3. Valve Specification Level (VSL)	VSL-1
4. Obturator Type	Manufacturer Standard
5. Valve Standard	Manufacturer Standard
6. Size Range (NPS)	¼" - 1 ½"
7. End Connection	NPT Female
8. Pressure Class	max. pressure 6000 psi
9. Temperature	0°C to 90°C
10. Material Class	Stainless Steel
11. Body Material	ASTM A182 Gr F316
12. obturator Material	AISI 316
13. Seat Material	N/A
14. Stem Seal	N/A
15. Operator Type	Not Applicable
16. Stem Construction	Not Applicable
17. Bonnet Construction	Not Applicable
18. Product Testing	FAT according manufacturer standard
19. Notes	Seal material shall be acc. "Group B" Annex A item A.7.1.5.6. Spring material acc. Manufacturer Standard.



## A.12.14 AXIAL CONTROL

Valve Code	VAC-150-1-C111
Specs	B10

# ANNEX B

## PIPES | FITTINGS | ACCESSORIES (Mandatory)

## INDEX

<b>B.1. SCOPE .....</b>	<b>3</b>
<b>B.2. NORMATIVE REFERENCES .....</b>	<b>3</b>
<b>B.3. TERMS AND DEFINITIONS .....</b>	<b>5</b>
<b>B.4. SYMBOLS AND ABBREVIATED TERMS .....</b>	<b>5</b>
<b>B.5. PIPES AND TUBES .....</b>	<b>5</b>
B.5.1. IDENTIFICATION CODE .....	5
B.5.2. GENERAL INFORMATION .....	5
<b>B.6. FITTINGS .....</b>	<b>5</b>
B.6.1. IDENTIFICATION CODE .....	5
B.6.2. GENERAL INFORMATION .....	8
<b>B.7. NIPPLES .....</b>	<b>8</b>
B.7.1. IDENTIFICATION CODE .....	8
<b>B.8. FLANGES .....</b>	<b>9</b>
B.8.1. IDENTIFICATION CODE .....	9
B.8.2. GENERAL INFORMATION .....	10
<b>B.9. GASKETS .....</b>	<b>10</b>
B.9.1. IDENTIFICATION CODE .....	10
B.9.2. GENERAL INFORMATION .....	11
<b>B.10. BOLTS AND NUTS .....</b>	<b>11</b>
B.10.1. IDENTIFICATION CODE .....	11
B.10.2. GENERAL INFORMATION .....	12
<b>B.11. ZINC-NICKEL COATING REQUIREMENTS .....</b>	<b>12</b>
<b>B.12. ALTERNATIVE MATERIALS .....</b>	<b>12</b>
<b>B.13. DATASHEETS .....</b>	<b>13</b>



## **B.1. SCOPE**

This document defines requirements and material data sheets for pipes, fittings, flanges, gaskets and bolts, for use in Exploration and Production (E&P) business area, onshore and offshore, especially in oil and gas production and process facilities.

## **B.2. NORMATIVE REFERENCES**

Note: The Standards referred herein shall be considered in their latest edition/revision.

ABNT NBR 5648 -Tubos e Conexões de PVC-U com Junta Soldável para Sistemas Prediais de Água Fria;

API SPEC 6A - Specification for Wellhead and Christmas Tree Equipment;

API SPEC 5L - Specification for Line Pipe;

ASME B1.1 - Unified Inch Screw Threads (UN and UNR Thread Form);

ASME B1.20.1 - Pipe Threads, General Purpose (Inch);

ASME B16.1 - Gray Iron Pipe Flanges and Flanged Fittings Classes 25, 125 and 250;

ASME B16.5 - Pipe Flanges and Flanged Fittings NPS 1/2 through NPS 24 Metric/Inch Standard;

ASME B16.9 - Factory-Made Wrought Steel Butt-Welding Fittings;

ASME B16.11 - Forged Fittings, Socket-Welding and Threaded;

ASME B16.14 - Ferrous Pipe Plugs, Bushings and Locknuts with Pipe Threads;

ASME B16.15 - Cast Copper Alloy Threaded Fitting Classes 125 and 250;

ASME B16.20 - Metallic Gaskets for Pipe Flanges Ring-Joint, Spiral-Wound and Jacketed;

ASME B16.21 - Nonmetallic Flat Gaskets for Pipe Flanges;

ASME B16.25 - Buttwelding Ends;

ASME B16.39 - Malleable Iron Threaded Pipe Unions Classes 150, 250 and 300;

ASME B16.47 - Large Diameter Steel Flanges NPS 26 through NPS 60 Metric/Inch Standard;

ASME B18.2.1 - Square, Hex, Heavy Hex, and Askew Head Bolts and Hex, Heavy Hex, Hex Flange, Lobed Head and Lag Screws (Inch Series);

ASME B18.2.2 - Nuts for General Applications: Machine Screw Nuts, Hex, Square, Hex Flange, and Coupling Nuts (Inch Series);

ASME B31.3 - Process Piping;

ASME B31.4 - Pipeline Transportation Systems for Liquid Hydrocarbons and Other Liquids;

ASME B31.8 - Gas Transmission and Distribution Piping Systems;

ASME B36.10 - Welded and Seamless Wrought Steel Pipe;

ASME B36.19 - Stainless Steel Pipe;

ASME BPVC Section VIII, Division I - Rules for Construction of Pressure Vessels;

ASTM A105/A105M - Standard Specification for Carbon Steel Forgings for Piping Applications;

ASTM A126 - Standard Specification for Gray Iron castings for Valves, Flanges, and Pipe Fittings;

ASTM A182/A182M - Standard Specification for Forged or Rolled Alloy and Stainless Steel Pipe Flanges, Forged Fittings, and Valves and Parts for High-Temperature Service;

ASTM A193/A193M - Standard Specification for Alloy-Steel and Stainless Steel Bolting for High Temperature Service or High Pressure Service and other Special Purpose Applications;

ASTM A194/A194M - Standard Specification for Carbon and Alloy Steel Nuts for Bolts for High Pressure or High Temperature Service, or Both;

ASTM A312/A312M - Standard Specification for Seamless, Welded, and Heavily Cold Worked Austenitic Stainless Steel Pipes;

ASTM A320/A320M - Standard Specification for Alloy-Steel and Stainless Steel Bolting for Low-Temperature Service;

ASTM A333/A333M - Standard Specification for Seamless and Welded Steel Pipe for Low-Temperature Service;

ASTM A335/A335M - Standard Specification for Seamless Ferritic Alloy-Steel Pipe for High-Temperature Service;

ASTM A350/A350M - Standard Specification for Carbon and Low-Alloy Steel Forgings, Requiring Notch Toughness Testing for Piping Components;

ASTM A358/A358M - Standard Specification for Electric-Fusion-Welded Austenitic Chromium-Nickel Stainless Steel Pipe for High-Temperature Service and General Applications;

ASTM A671/A671M - Standard Specification for Electric-Fusion-Welded Steel Pipe for Atmospheric and Lower Temperatures;

ASTM A672/A672M - Standard Specification for Electric-Fusion-Welded Steel Pipe for High-Pressure Service at Moderate Temperatures;

ASTM A733 - Standard Specification for Welded and Seamless Carbon Steel and Austenitic Stainless Steel Pipe Nipples;

ASTM B841 - Standard Specification for Electrodeposited Coatings of Zinc Nickel Alloy Deposits

ASTM B849 - Standard Specification for Pre-Treatments of Iron or Steel for Reducing Risk of Hydrogen Embrittlement

ASTM B850 - Standard Guide for Post-Coating Treatments of Steel for Reducing the Risk of Hydrogen Embrittlement

ASTM F 1378 - Standard specification for performance of piping and tubing mechanically attached fittings

ASTM B62 - Standard Specification for Composition Bronze or Ounce Metal Castings;

EEMUA 144 - 90/10 copper nickel alloy piping for offshore applications – specification: tubes seamless and welded

EEMUA 145 - 90/10 copper nickel alloy piping for offshore applications – specification: flanges composite and solid

EEMUA 146 - 90/10 copper nickel alloy piping for offshore applications – specification: fittings

MSS SP-6 - Standard Finishes for Contact Faces of Pipe Flanges and Connecting - End Flanges of Valves and Fittings;

MSS SP-43 - Wrought and Fabricated Butt-Welding Fittings for Low Pressure, Corrosion Resistant Applications;

MSS SP-83 - Class 3 000 Steel Pipe Unions, Socket Welding and Threaded;

MSS SP-95 - Swage (d) Nipples and Bull Plugs;

MSS SP-97 - Integrally Reinforced Forged Branch Outlet Fittings - Socket Welding, Threaded and Buttwelding Ends.

ISO 27509 - Petroleum and natural gas industries – compact flanged connections with IX seal ring

### B.3. TERMS AND DEFINITIONS

### B.4. SYMBOLS AND ABBREVIATED TERMS

For the purposes of this document, the following symbols and abbreviated terms apply:

### B.5. PIPES AND TUBES

#### B.5.1. IDENTIFICATION CODE

Each pipe datasheet is identify by a code which follow the rule below:

**T-XY**

Where:

**X** - Pipe material code, according to Table B.1.

**YY** - Sequential number.

Table B.1 - Pipe material codes

MATERIAL	CODE X
CARBON STEEL	1
ALLOYS AND ALLOY STEELS	2
STAINLESS STEEL	3
NON METTALICS	4

#### B.5.2. GENERAL INFORMATION

B.5.2.1. Shall not be used the following diameters (NPS): 3 ½, 5 and 22. NPS 1 ¼ and 2 ½ may be used only in non-metallic piping and fittings.

B.5.2.2. The minimum piping diameter is NPS 1 for organic coat specs (11 and 14 group) in order to minimize flanges connections.

B.5.2.3. The organic coating shall be according to annex F.

B.5.2.4. Specs with Inconel clad pipes shall have monolithic pipes under NPS 4. For NPS 4 and greater the Inconel cladding shall be according to annex G.

B.5.2.5. The thickness calculation for piggable specs is according to ASME B31.4/B31.8 for NPS equal and greater than NPS 4. Under NPS 4 the thickness is according to ASME B31.3.

### B.6. FITTINGS

#### B.6.1. IDENTIFICATION CODE

Each fitting datasheet is identify by a code which follow the rule below:

**CXX.Y-ZZ**

Where:

**XX** - Fitting type, according to Table B.2.

**Y** - Sequential number to use when necessary.

**ZZ** - Fitting material codes according to Table B.2.

Table B.2 - Fitting type and material

FITTING TYPE	CODE CXX.Y	FITTING TYPE	CODE CXX.Y
Elbow 90°	C01	Connector	C37
Elbow 45°	C02	Union Connector	C38
Tee	C03	Stub End type L	C39
Reduction Tee	C04	Elbow 45° - MAF	C40
Cross	C05	Elbow 90° - MAF	C41
Coupling	C06	Coupling - MAF	C42
Half Coupling	C07	Tee - MAF	C43
Reduction Coupling	C08	Union - MAF	C44
Plug	C09	Cap - MAF	C45
Union	C10	Union – Plain seat type with isolation gasket	C46
Cap	C11	Cap - MAF	C45
Weldolet	C12	Union – Flexible lug nut type	C47
Elbow 90° LR (B16.9)	C15	45° Tee	C48
Elbow 45° LR (B16.9)	C16	22°30' Elbow	C49
Elbow 90° SR (B16.9)	C17	11°15' deg Elbow	C50
Reduction Concentric (B16.9)	C18	Flanged Saddle	C51
Reduction Eccentric (B16.9)	C19	Threaded Saddle Flg	C52
Tee (B16.9)	C20	Reduction Cross	C53
Reduction Tee (B16.9)	C21	Thredolet	C54
Cap (B16.9)	C22	Sockolet	C55
Reduction Bushing	C23	Reducer Bushing	C56
Cross (B16.9)	C24	Sweepolet	C57
Elbow 45° 3D Radius	C33	Y Tee - 30 Deg	C58
Elbow 45° 5D Radius	C34	Reduction Y Tee - 30 Deg	C59
Elbow 90° 3D Radius	C35	Cap Threade End	C60
Elbow 90° 5D Radius	C36	Elbow 45° SR	C61
		Flanged Nipolet	C62

MATERIAL	CODE ZZ
A105	2
A234 WPB	3
A350 LF2 CI 1	4
A420 WPL6	5
A420 WPL3	11
A182 F316L	14
A403 WP316L	15
API 5L B PSL 1 SML	20
API 5L X65 PSL 2	21
A860 WPHY65	22
A333 8	23
A420 WPL8	24
A522 Tp I	25
A182 F316	26
A182 F51 (UNS S31803)	27
A790 (UNS S31803)	28
A815 (UNS S31803)	29
A182 F55 (UNS S32760)	30
A790 (UNS S32760)	31
A815 (UNS S32760)	32
B366 (UNS N06625)	33
Cu-Ni 70/30	34
Cu-Ni 90/10 (UNS C70620)	35
B62 (UNS C83600)	36
A333 6	37
A312 TP316L	38
B444 1 (UNS N06625)	39
AISI 316	40
ASTM A312 TP310H	41
ASTM A 403 Gr WP 316/316L	44
ASTM A 312 TP 316 / 316L	45
PVC	50
CPVC	51
FRP - Bisphenol A Epoxy resins reinforced with fiberglass type E or E-CR. Design pressure 10bar@90°C	52

MATERIAL	CODE ZZ
FRP Epoxy vinylester resins (bisphenol A ou brominated) reinforced with fiberglass type E-CR, inner liner with fiberglass veils type C. Suitable for 85°C and 16 bar.	53
FRP Bisphenol A Epoxy resins reinforced with fiberglass type E or E-CR, inner liner with fiberglass veils type C or synthetic organic fibers. Suitable for 90 °C and 10 bar.	54
FRP Bisphenol A Epoxy resins reinforced with fiberglass type E or E-CR, inner liner with fiberglass veils type C or synthetic organic fibers. Suitable for 90 °C and 16 bar.	55
FRP Bisphenol A Epoxy vinylester resins reinforced with fiberglass type E or E-CR, inner liner with fiberglass veils type C or synthetic organic fibers. Suitable for 90 °C and 10 bar.	56
FRP Bisphenol A Epoxy resins reinforced with fiberglass type E or E-CR, inner liner with fiberglass veils type C or synthetic organic fibers. Suitable for 120 °C and 16 bar.	57
RPVC RJ/BS	58
RPVC RJ/SS	59
RPVC EJ/BS	60
FRP Bisphenol A Epoxy vinylester resins reinforced with fiberglass type E or E-CR, inner liner with fiberglass veils type C or synthetic organic fibers. Suitable for 90 °C and 16 bar.	61



## B.6.2. GENERAL INFORMATION

B.6.2.1. Maximum allowed thickness reduction for 3D and 5D pipe bends are 15% and 10%, respectively.

B.6.2.2. The organic coating shall be according to Annex F.

B.6.2.3. The Inconel cladding shall be according to Annex G.

## B.7. NIPPLES

### B.7.1. IDENTIFICATION CODE

Each nipple datasheet is identify by a code which follow the rule below:

**N-XXYY**

Where:

**XX** - Code that identify the relation of nipple types with end type, according to Table B.3.

**YY** - Nipple material code, according to Table B.3.

Table B.3 – Nipple type and material

CODE XX									
END TYPE	PE	BE	TE	BE x PE	BE x TE	MAF	Female TE X Male Capilar	Male TE X Male Capilar	PE X TE
CONCENTRIC	C1	C2	C3	C4	C5	C6	-	-	
ECCENTRIC	E1	E2	E3	E4	E5	-	-	-	
STRAIGHT	S1	S2	S3	-	-	-	-	-	S9
CONNECTOR	-	-	A3	-	-	-	A7	A8	

MATERIAL	CODE
	YY
ASTM A105	2
ASTM A234 Gr WPB	3
ASTM A350 Gr LF2 Cl 1	4
ASTM A420 Gr WPL6	5
ASTM A420 Gr WPL3	11
ASTM A182 Gr F316L	14
ASTM A403 Gr WP316L	15
API 5L Gr B PSL 1 seamless	20
API 5L Gr X65 PSL 2	21
ASTM A860 WPHY65	22
ASTM A333 Gr 8	23
ASTM A420 Gr WPL8	24

MATERIAL	CODE
	YY
ASTM B366 (UNS N06625)	33
Cu-Ni 70/30	34
Cu-Ni 90/10 (UNS C70620)	35
ASTM B62 (UNS C83600)	36
ASTM A333 Gr 6	37
ASTM A312 TP316L	38
ASTM B444 Gr 1 (UNS N06625)	39
PVC - ASTM D1785 class 1120	50
CPVC - ASTM F441 class 4120	51
RPVC-Glass fiber reinforced PVC	52
Glass fiber reinforced plastic suitable for 70°C and 16 bar	53

ASTM A522 Type I	25	Glass fiber reinforced plastic suitable for 90°C and 10 bar	54
ASTM A182 Gr F316	26		
ASTM A182 Gr F51 (UNS S31803)	27		
ASTM A790 (UNS S31803)	28		
ASTM A815 (UNS S31803)	29		
ASTM A182 Gr F55 (UNS S32760)	30		
ASTM A790 (UNS S32760)	31		
ASTM A815 (UNS S32760)	32	Glass fiber reinforced plastic suitable for 90°C and 16 bar	55
		Glass fiber reinforced plastic suitable for 120°C and 10 bar	56
		Glass fiber reinforced plastic suitable for 120°C and 16 bar	57

## B.8. FLANGES

### B.8.1. IDENTIFICATION CODE

Each flange datasheet is identify by a code which follow the rule below:

### *F-class-XY*

Where:

**Class** – Pressure class, according to Table B.4.

**X** – Code that identify the relation of flange face with flange type, according to Table B.4.

**Y** – Flange material codes according to Table B.4.

Table B.4 - Codes for flanges

CLASS	
150	ASME B16.5 ou B16.47
300	ASME B16.5 ou B16.47
600	ASME B16.5 ou B16.47
900	ASME B16.5 ou B16.47
1500	ASME B16.5
2500	ASME B16.5 ou ISO 27509
10000	API 6A
20	EEMUA
16	D4024
25	D4024

MATERIAL	CODE Y
ASTM A105 Galvanized	1
ASTM A105	2
ASTM A350 Gr LF2 CL1	3
ASTM A182 Gr F5	4
ASTM A350 Gr LF3	5
ASTM A182 Gr F304L	6
ASTM A182 Gr F316L	7
ASTM A182 Gr F11	8
ASTM A182 Gr F317L	9
ASTM A182 Gr F347	A
ASTM A105 with cladded	B
ASTM A694 Gr F65	C
ASTM A694 Gr F65 cladded	D
ASTM A350 Gr LF3 cladded	E
ASTM A182 Gr F316	F
ASTM A182 Gr F51	G
ASTM A182 Gr F55	H
ASTM A522 Type 1	J
ASTM A522 Tipo 1 cladded	K

CODE X											
Face Type	Flange type										
	THD	SO	SW	WN	BL	OR	RJ	EJ	BF	MAF	INT
FF	A	B	C	D	E	F	W	X			1
RF	G	H	J	K	L	M			Y	Z	

RTJ	N	P	Q	R	S	T					
MSJ				U	V						

ASTM B564	L
Cu-Ni 90/10	M
Cu-Ni 70/30	N
PVC	P
CVPC	Q
RPVC	R
FRP 70°C	S
FRP 90°C	T
FRP 120°C	U

### B.8.2. GENERAL INFORMATION

B.8.2.1. The organic coating shall be according to Annex F.

B.8.2.2. The Inconel cladding shall be according to Annex G.

B.8.2.3. The composite welding neck flange is according to EEMUA 145, composed of a backing flange and a stub end type L. The backing flange shall be epoxy coated following annex F recommendations.

### B.9. GASKETS

#### B.9.1. IDENTIFICATION CODE

Each Gasket datasheet is identify by a code which follow the rule below:

## *J-class-XY*

Where:

**Class** – Pressure class, according to Table B.5.

**X** – Code that identify the relation of flange face with gasket type, according to Table B.5.

**Y** – Flange material codes according to Table B.5.

Table B.5 - Codes for gaskets

Flange Standard	Class
ASME B16.1	125
ASME B16.5 and ASME B16.47	150
	300
	600
	900
	1500
ASME B16.5 / ISO 27509	2500
API 6A	10000

MATERIAL	FILLER	Inner Ring	Centering Ring	Facing layer	CODE Y
Aramide Fiber	-	-	-	-	A
Neoprene	-	-	-	-	B
PTFE expanded	-	-	-	-	C
SBR	-	-	-	-	D
AISI 304	Graphite	AISI 304	Carbon steel	-	E
AISI 316	Graphite	AISI 316	Carbon steel	-	F
AISI 316	Graphite	AISI 317	Carbon steel	-	G
AISI 316	Graphite	AISI 316	AISI 316	-	H
AISI 347	Graphite	-	Carbon steel	-	J
MONEL	PTFE	MONEL	Carbon steel	-	K
Duplex	Graphite	Duplex	AISI 316	-	L
Inconel 625	Graphite	Inconel 625	AISI 316	-	M
Carbon Steel	-	-	-	-	N
A182 F5	-	-	-	-	P

CODE X				
Gasket type	Face type			
	FP	FR	FJA	MSJ

Flat	C	P		
Spiral Wound		E		
Ring Joint			A	B
Grooved		G		
Isolation	D	F	H	

A182 F11	-	-	-	-	Q
A182 F347	-	-	-	-	R
AISI 304	-	-	-	-	S
AISI 316	-	-	-	-	T
A182 F51	-	-	-	-	U
Inconel 625	-	-	-	-	V
A522 TP I	-	-	-	-	W
AISI 316	-	-	-	PTFE	X
Phenolic	-	-	-	Nitrile Rubber	Y
AISI 316	-	-	-	G10	Z

### B.9.2. GENERAL INFORMATION

B.9.2.1. The Zinc-Nickel coating indicated in gaskets datasheets shall be according to item B.11.

B.9.2.2. Electric isolation gasket shall be according to Annex J.

## B.10. BOLTS AND NUTS

### B.10.1. IDENTIFICATION CODE

Each Bolt and nut datasheet, is identify by a code which follow the rule below:

***P-class-XX***

Where:

**Class** – Flange pressure class

**XX** - Sequential number.

Table B.6 - Codes for Bolts and Nuts

BOLT MATERIAL	NUT MATERIAL	CODE XX
ASTM A193 Gr. B7	ASTM A194 Gr. 2H	01
ASTM A320 Gr. L7	ASTM A194 Gr. 4L	02
ASTM A 193 Gr. B7, revestido em Zn-Ni	ASTM A 194 Gr. 2H, revestido em Zn-Ni	07
ASTM A 320 Gr. L7, revestido em Zn-Ni	ASTM A 194 Gr. 4L, revestido em Zn-Ni	08
ASTM A320 Gr. L43, revestido em Zn-Ni	ASTM A194 Gr. 4L, revestido em Zn-Ni	09

### B.10.2. GENERAL INFORMATION

B.10.2.1. The studs, bolts and nuts shall be coated with zinc-nickel (Zn-Ni) according to item B.11.

### B.11. ZINC-NICKEL COATING REQUIREMENTS

B.11.1. The procedure for studs, bolts, nuts, washers and gaskets Zn-Ni coating shall be in accordance with I-ET-3010.00-1200-251-P4X-001 - REQUIREMENTS FOR BOLTING MATERIALS.

### B.12. ALTERNATIVE MATERIALS

B.12.1. All materials listed in pipe specs shall be considered as standardized materials. Therefore, alternative materials (equivalent or better) may be proposed, conditioned to PETROBRAS approval.

B.12.2. When substitutions were made shall be verified the wall thickness and the piping spec shall be updated.

B.12.3. Other alternative materials may be acceptable subject to Petrobras approval.

B.12.4. Some examples of alternative materials are in Table B.7

Table B.7 – Alternative Materials

Standardized material	Alternative material
API 5L Gr B	ASTM A 106 Gr B
API 5L Gr B	API 5L Gr X65 PSL 2
API 5L Gr B	ASTM A333 GR 6
Super duplex UNS S32760	Super duplex UNS S32750
Duplex UNS 31803	Super duplex UNS S32760 or UNS S32750
ASTM A105	ASTM A350 LF2
ASTM A234 WPB	ASTM A420 WPL6



## B.13. DATASHEETS

1. PIPES

PIPE

Commodity Code	T-102
Specs	B4 B9 B10 B11 B14 B30 C8 C10 C11 C30 E8 E34 G10
1. Item	Pipe
2. Material	API 5L Gr B PSL 1
3. Standard	ASME B36.10
4. Schedule	-
5. Ends	½" - 1 ½" NPT Threaded End, Plain End 2" - 44" Beveled End
6. Seam Type	½" - 1 ½" Seamless 2" - 14" HFW, SAW, Seamless 16" - 24" HFW, SAW 26" - 44" SAW
7. Size Range (NPS)	½" - 44"
8. Additional Requirement	-

Commodity Code	T-105
Specs	B6 C6 E6 E19 F6
1. Item	Pipe
2. Material	ASTM A333 Gr 6
3. Standard	ASME B36.10
4. Schedule	-
5. Ends	½" - 1 ½" Plain End 2" - 28" Beveled End
6. Seam Type	½" - 10" Seamless 12" - 14" Seamless, welded 16" - 28" welded
7. Size Range (NPS)	½" - 28"
8. Additional Requirement	-

Commodity Code	T-106
Specs	B6 C6 E6 E19 F6
1. Item	Pipe
2. Material	ASTM A671 Gr CC60 Class 22
3. Standard	ASME B36.10
4. Schedule	-
5. Ends	Beveled End
6. Seam Type	2" - 10" Seamless 12" - 14" Seamless, welded 16" - 44" welded
7. Size Range (NPS)	2" - 44"
8. Additional Requirement	-

Commodity Code	T-107
Specs	E30 E34 G10 H30
1. Item	Pipe
2. Material	API 5L Gr X65 PSL 2
3. Standard	ASME B36.10
4. Schedule	-
5. Ends	1" - 1 ½" Plain End 2" - 34" Beveled End
6. Seam Type	1" - 1 ½" Seamless 2" - 14" SAW, Seamless 16" - 34" SAW
7. Size Range (NPS)	1" - 34"
8. Additional Requirement	-

Commodity Code	T-202
Specs	B7
1. Item	Pipe
2. Material	Cu-Ni 90/10 (UNS C7060X)
3. Standard	EEMUA 234
4. Schedule	-
5. Ends	½" - 2" Plain End 2 ½" - 36" Beveled End
6. Seam Type	½" - 4" Seamless 6" - 16" Seamless, welded 18" - 36" welded
7. Size Range (NPS)	½" - 36"
8. Additional Requirement	-

Commodity Code	T-203
Specs	B30 C30 E30 H30
1. Item	Pipe
2. Material	ASTM B444 Gr 1 (UNS N06625)
3. Standard	ASME B36.10/B36.19
4. Schedule	-
5. Ends	½" - 1 ½" Plain End 2" - 14" Beveled End
6. Seam Type	Seamless
7. Size Range (NPS)	½" - 14"
8. Additional Requirement	-

Commodity Code	T-217
Specs	
1. Item	Pipe
2. Material	ASTM A671 Gr CFE70 Class 32
3. Standard	ASME B36.10
4. Schedule	-
5. Ends	-
6. Seam Type	-
7. Size Range (NPS)	-
8. Additional Requirement	-

Commodity Code	T-301
Specs	B16 C16 E16 G16P G16 H16
1. Item	Pipe
2. Material	ASTM A790 (UNS S31803)
3. Standard	ASME B36.10/B36.19
4. Schedule	-
5. Ends	½" - 1 ½" Plain End 2" - 14" Beveled End
6. Seam Type	½" - 8" Seamless 10" - 14" welded
7. Size Range (NPS)	½" - 14"
8. Additional Requirement	-

Commodity Code	T-302
Specs	B16 C16 E16 G16P G16 H16
1. Item	Pipe
2. Material	ASTM A928 (UNS S31803 Cl 1 or 3)
3. Standard	ASME B36.10/B36.19
4. Schedule	-
5. Ends	Beveled End
6. Seam Type	welded
7. Size Range (NPS)	10" - 40"
8. Additional Requirement	-

Commodity Code	T-303
Specs	B12 H12P H12
1. Item	Pipe
2. Material	ASTM A790 (UNS S32760)
3. Standard	ASME B36.10/B36.19
4. Schedule	-
5. Ends	½" - 1 ½" Plain End 2" - 8" Beveled End
6. Seam Type	Seamless 8" welded
7. Size Range (NPS)	½" - 8"
8. Additional Requirement	-

Commodity Code	T-304
Specs	B12 H12P H12
1. Item	Pipe
2. Material	ASTM A928 (UNS S32760 Cl 1 or 3)
3. Standard	ASME B36.10/B36.19
4. Schedule	-
5. Ends	½" - 1 ½" Plain End 2" - 48" Beveled End
6. Seam Type	½" - 8" Seamless 10" - 48" welded
7. Size Range (NPS)	½" - 48"
8. Additional Requirement	-

Commodity Code	T-322
Specs	B3 C3 E3 G3 H3
1. Item	Pipe
2. Material	ASTM A312 TP 316/316L
3. Standard	ASME B36.19
4. Schedule	-
5. Ends	½" - 1 ½" Plain End 2" - 6" Beveled End
6. Seam Type	½" - 1 ½" Seamless 2" - 6" welded
7. Size Range (NPS)	½" - 6"
8. Additional Requirement	-

Commodity Code	T-323
Specs	B3 C3 E3 G3 H3
1. Item	Pipe
2. Material	ASTM A358 Type 316/316L Cl 1 or 3
3. Standard	ASME B36.10/B36.19
4. Schedule	-
5. Ends	Beveled End
6. Seam Type	welded
7. Size Range (NPS)	2" - 44"
8. Additional Requirement	-

Commodity Code	T-325
Specs	T60A
1. Item	Pipe
2. Material	A269 (UNS S31254)
3. Standard	-
4. Schedule	-
5. Ends	Plain End
6. Seam Type	Seamless
7. Size Range (NPS)	½" - 1 ½"
8. Additional Requirement	-

Commodity Code	T-404
Specs	B22
1. Item	Pipe
2. Material	FRP - Bisphenol A Epoxy resins reinforced with fiberglass type E or E-CR. Design pressure 10 bar@90°C.
3. Standard	ISO 14692
4. Schedule	-
5. Ends	½" - ¾" Plain End 1" - 8" Butt-Strap, Elastic Joint / Bell x Spigot Ends, Plain End, Rigid Joint / Bell x Spigot Ends, Rigid Joint / Spigot Ends 10" - 28" Butt-Strap, Elastic Joint / Bell x Spigot Ends, Rigid Joint / Bell x Spigot Ends, Rigid Joint / Spigot Ends 30" - 48" Butt-Strap
6. Seam Type	Seamless
7. Size Range (NPS)	½" - 48"
8. Additional Requirement	-

Commodity Code	T-405
Specs	
1. Item	Pipe
2. Material	FRP - Bisphenol A Epoxy vinyl ester resins reinforced with fiberglass type E or E-CR. Design pressure 10 bar@90°C.
3. Standard	ISO 14692
4. Schedule	-
5. Ends	-
6. Seam Type	-
7. Size Range (NPS)	-
8. Additional Requirement	-

Commodity Code	T-406
Specs	B23
1. Item	Pipe
2. Material	FRP - Bisphenol A Epoxy resins reinforced with fiberglass type E or E-CR. Design pressure 16 bar@90°C.
3. Standard	ISO 14692
4. Schedule	-
5. Ends	Butt-Strap
6. Seam Type	Seamless
7. Size Range (NPS)	1" - 64"
8. Additional Requirement	-

Commodity Code	T-407
Specs	
1. Item	Pipe
2. Material	FRP - Bisphenol A Epoxy vinyl ester resins reinforced with fiberglass type E or E-CR. Design pressure 16 bar@90°C.
3. Standard	ISO 14692
4. Schedule	-
5. Ends	-
6. Seam Type	-
7. Size Range (NPS)	-
8. Additional Requirement	-

Commodity Code	T-408
Specs	B26
1. Item	Pipe
2. Material	FRP - Bisphenol A Epoxy resins reinforced with fiberglass type E or E-CR. Design pressure 16 bar@120°C.
3. Standard	ISO 14692
4. Schedule	-
5. Ends	Butt-Strap
6. Seam Type	Seamless
7. Size Range (NPS)	1" - 36"
8. Additional Requirement	-

Commodity Code	T-409
Specs	B27
1. Item	Pipe
2. Material	FRP - Epoxy vinyl ester resins (bisphenol A brominated) reinforced with fiberglass type E-CR, inner liner with fiberglass veils type C. Design pressure 16 bar@85°C.
3. Standard	ISO 14692
4. Schedule	-
5. Ends	Butt-Strap
6. Seam Type	Seamless
7. Size Range (NPS)	1" - 6"
8. Additional Requirement	-

Commodity Code	T-410
Specs	B28 C23
1. Item	Pipe
2. Material	FRP - Bisphenol A Epoxy resins reinforced with fiberglass type E or E-CR. Design pressure 25 bar@90°C.
3. Standard	ISO 14692
4. Schedule	-
5. Ends	Butt-Strap
6. Seam Type	Seamless
7. Size Range (NPS)	1" - 40"
8. Additional Requirement	-

2. FITTINGS

B12.2.1 5D 45 DEG PIPE BEND

Commodity Code	!! EXISTING !! C34-39 ID155040
Specs	
1. Fitting type	5D 45 deg Pipe Bend
2. Material	ASTM B444 Gr 1 (UNS N06625)
3. Standard	ASME B31.8 (ISO 15590-1 or ASME B16.49)
4. Pressure class or thickness	-
5. End connections	Beveled end
6. Size Range (NPS)	-
7. Additional requirement	-
8. Weight	-
9. Dimension	-

Commodity Code	C34-28
Specs	G16P
1. Fitting type	5D 45 deg Pipe Bend
2. Material	ASTM A790 (UNS S31803)
3. Standard	NORSOK M-630 NBE2
4. Pressure class or thickness	-
5. End connections	Beveled end
6. Size Range (NPS)	2" - 14"
7. Additional requirement	-
8. Weight	-
9. Dimension	-

Commodity Code	C34-31
Specs	H12P
1. Fitting type	5D 45 deg Pipe Bend
2. Material	ASTM A790 (UNS S32760)
3. Standard	NORSOK M-630 NBE2
4. Pressure class or thickness	-
5. End connections	Beveled end
6. Size Range (NPS)	2" - 18"
7. Additional requirement	-
8. Weight	-
9. Dimension	-

Commodity Code	C34-41
Specs	H12P
1. Fitting type	5D 45 deg Pipe Bend
2. Material	ASTM A928 (UNS S32760 Cl 1 or 3)
3. Standard	NORSOK M-630 NBE2
4. Pressure class or thickness	-
5. End connections	Beveled end
6. Size Range (NPS)	10" - 18"
7. Additional requirement	-
8. Weight	-
9. Dimension	-

Commodity Code	C34-42
Specs	G16P
1. Fitting type	5D 45 deg Pipe Bend
2. Material	ASTM A928 (UNS S31803 Cl 1 or 3)
3. Standard	NORSOK M-630 NBE2
4. Pressure class or thickness	-
5. End connections	Beveled end
6. Size Range (NPS)	10" - 14"
7. Additional requirement	-
8. Weight	-
9. Dimension	-

Commodity Code	C34-46
Specs	
1. Fitting type	5D 45 deg Pipe Bend
2. Material	ASTM A358 TP316/316L
3. Standard	ASME B31.8 (ISO 15590-1 or ASME B16.49)
4. Pressure class or thickness	-
5. End connections	Beveled end
6. Size Range (NPS)	-
7. Additional requirement	-
8. Weight	-
9. Dimension	-

B12.2.2 5D 90 DEG PIPE BEND

Commodity Code	!! EXISTING !! C36-39 ID155044
Specs	
1. Fitting type	5D 90 deg Pipe Bend
2. Material	ASTM B444 Gr 1 (UNS N06625)
3. Standard	ASME B31.8 (ISO 15590-1 or ASME B16.49)
4. Pressure class or thickness	-
5. End connections	Beveled end
6. Size Range (NPS)	-
7. Additional requirement	-
8. Weight	-
9. Dimension	-

Commodity Code	C36-28
Specs	G16P
1. Fitting type	5D 90 deg Pipe Bend
2. Material	ASTM A790 (UNS S31803)
3. Standard	NORSOK M-630 NBE2
4. Pressure class or thickness	-
5. End connections	Beveled end
6. Size Range (NPS)	2" - 14"
7. Additional requirement	-
8. Weight	-
9. Dimension	-

Commodity Code	C36-31
Specs	H12P
1. Fitting type	5D 90 deg Pipe Bend
2. Material	ASTM A790 (UNS S32760)
3. Standard	NORSOK M-630 NBE2
4. Pressure class or thickness	-
5. End connections	Beveled end
6. Size Range (NPS)	4" - 8"
7. Additional requirement	-
8. Weight	-
9. Dimension	-

Commodity Code	C36-41
Specs	H12P
1. Fitting type	5D 90 deg Pipe Bend
2. Material	ASTM A928 (UNS S32760 Cl 1 or 3)
3. Standard	NORSOK M-630 NBE2
4. Pressure class or thickness	-
5. End connections	Beveled end
6. Size Range (NPS)	10" - 18"
7. Additional requirement	-
8. Weight	-
9. Dimension	-

Commodity Code	C36-42
Specs	G16P
1. Fitting type	5D 90 deg Pipe Bend
2. Material	ASTM A928 (UNS S31803 Cl 1 or 3)
3. Standard	NORSOK M-630 NBE2
4. Pressure class or thickness	-
5. End connections	Beveled end
6. Size Range (NPS)	10" - 14"
7. Additional requirement	-
8. Weight	-
9. Dimension	-

Commodity Code	C36-46
Specs	
1. Fitting type	5D 90 deg Pipe Bend
2. Material	ASTM A358 TP316/316L
3. Standard	ASME B31.8 (ISO 15590-1 or ASME B16.49)
4. Pressure class or thickness	-
5. End connections	Beveled end
6. Size Range (NPS)	-
7. Additional requirement	-
8. Weight	-
9. Dimension	-

B12.2.3 90 DEG ELBOW, B16.11

Commodity Code	C01-02
Specs	B4 B9 B10 C8 C10 E8 E34 G10
1. Fitting type	90 deg Elbow, B16.11
2. Material	ASTM A105
3. Standard	ASME B16.11
4. Pressure class or thickness	3000 1/2" - 1 1/2" 2000, 6000, 9000
5. End connections	NPT Threaded End 1/2" - 1 1/2" Socket weld
6. Size Range (NPS)	1/2" - 2"
7. Additional requirement	-
8. Weight	-
9. Dimension	-

Commodity Code	C01-04
Specs	B6 C6 E6 E19 F6
1. Fitting type	90 deg Elbow, B16.11
2. Material	ASTM A350 Gr LF2 Cl 1
3. Standard	ASME B16.11
4. Pressure class or thickness	3000, 6000, 9000
5. End connections	Socket weld
6. Size Range (NPS)	1/2" - 1 1/2"
7. Additional requirement	-
8. Weight	-
9. Dimension	-

Commodity Code	C01-24
Specs	
1. Fitting type	90 deg Elbow, B16.11
2. Material	ASTM A420 Gr WPL8
3. Standard	ASME B16.11
4. Pressure class or thickness	-
5. End connections	-
6. Size Range (NPS)	-
7. Additional requirement	-
8. Weight	-
9. Dimension	-

Commodity Code	C01-27
Specs	B16 C16 E16 G16P G16
1. Fitting type	90 deg Elbow, B16.11
2. Material	ASTM A182 Gr F51 (UNS S31803)
3. Standard	ASME B16.11
4. Pressure class or thickness	3000
5. End connections	Socket weld
6. Size Range (NPS)	1/2" - 1 1/2"
7. Additional requirement	-
8. Weight	-
9. Dimension	-

Commodity Code	C01-30
Specs	B12
1. Fitting type	90 deg Elbow, B16.11
2. Material	ASTM A182 Gr F55 (UNS S32760)
3. Standard	ASME B16.11
4. Pressure class or thickness	3000
5. End connections	Socket weld
6. Size Range (NPS)	1/2" - 1 1/2"
7. Additional requirement	-
8. Weight	-
9. Dimension	-

Commodity Code	C01-33
Specs	B30 C30 E30
1. Fitting type	90 deg Elbow, B16.11
2. Material	ASTM A350 Gr LF2 Cl 1
3. Standard	ASME B16.11
4. Pressure class or thickness	3000
5. End connections	Socket weld
6. Size Range (NPS)	1/2" - 1 1/2"
7. Additional requirement	-
8. Weight	-
9. Dimension	-

Commodity Code	C01-35
Specs	B7
1. Fitting type	90 deg Elbow, B16.11
2. Material	Cu-Ni 90/10 (UNS C7060X)
3. Standard	EEMUA 234
4. Pressure class or thickness	20 bar
5. End connections	Female Capilar
6. Size Range (NPS)	1/2" - 1 1/2"
7. Additional requirement	-
8. Weight	-
9. Dimension	-

Commodity Code	C01-43
Specs	B3 C3 E3 G3
1. Fitting type	90 deg Elbow, B16.11
2. Material	ASTM A182 Gr F316/316L
3. Standard	ASME B16.11
4. Pressure class or thickness	3000
5. End connections	Socket weld
6. Size Range (NPS)	1/2" - 1 1/2"
7. Additional requirement	-
8. Weight	-
9. Dimension	-

B12.2.4 45 DEG ELBOW, B16.11

Commodity Code	C02-02
Specs	B4 B9 B10 C8 C10 E8 E34 G10
1. Fitting type	45 deg Elbow, B16.11
2. Material	ASTM A105
3. Standard	ASME B16.11
4. Pressure class or thickness	3000, 6000, 9000
5. End connections	NPT Threaded End, Socket weld
6. Size Range (NPS)	1/2" - 1 1/2"
7. Additional requirement	-
8. Weight	-
9. Dimension	-

Commodity Code	C02-04
Specs	B6 C6 E6 E19 F6
1. Fitting type	45 deg Elbow, B16.11
2. Material	ASTM A350 Gr LF2 Cl 1
3. Standard	ASME B16.11
4. Pressure class or thickness	3000, 6000, 9000
5. End connections	Socket weld
6. Size Range (NPS)	1/2" - 1 1/2"
7. Additional requirement	-
8. Weight	-
9. Dimension	-

Commodity Code	C02-27
Specs	B16 C16 E16 G16P G16
1. Fitting type	45 deg Elbow, B16.11
2. Material	ASTM A182 Gr F51 (UNS S31803)
3. Standard	ASME B16.11
4. Pressure class or thickness	3000
5. End connections	Socket weld
6. Size Range (NPS)	1/2" - 1 1/2"
7. Additional requirement	-
8. Weight	-
9. Dimension	-

Commodity Code	C02-30
Specs	B12
1. Fitting type	45 deg Elbow, B16.11
2. Material	ASTM A182 Gr F55 (UNS S32760)
3. Standard	ASME B16.11
4. Pressure class or thickness	3000
5. End connections	Socket weld
6. Size Range (NPS)	1/2" - 1 1/2"
7. Additional requirement	-
8. Weight	-
9. Dimension	-

Commodity Code	C02-33
Specs	B30 C30 E30
1. Fitting type	45 deg Elbow, B16.11
2. Material	ASTM B366 (UNS N06625)
3. Standard	ASME B16.11
4. Pressure class or thickness	3000
5. End connections	Socket weld
6. Size Range (NPS)	1/2" - 1 1/2"
7. Additional requirement	-
8. Weight	-
9. Dimension	-

Commodity Code	C02-35
Specs	B7
1. Fitting type	45 deg Elbow, B16.11
2. Material	Cu-Ni 90/10 (UNS C7060X)
3. Standard	EEMUA 234
4. Pressure class or thickness	20 bar
5. End connections	Female Capilar
6. Size Range (NPS)	1/2" - 1 1/2"
7. Additional requirement	-
8. Weight	-
9. Dimension	-

Commodity Code	C02-43
Specs	B3 C3 E3 G3
1. Fitting type	45 deg Elbow, B16.11
2. Material	ASTM A182 Gr F316/316L
3. Standard	ASME B16.11
4. Pressure class or thickness	3000
5. End connections	Socket weld
6. Size Range (NPS)	1/2" - 1 1/2"
7. Additional requirement	-
8. Weight	-
9. Dimension	-

B12.2.5 TEE, B16.11

Commodity Code	C03-02
Specs	B4 B9 B10 C8 C10 E8 E34 G10
1. Fitting type	Tee, B16.11
2. Material	ASTM A105
3. Standard	ASME B16.11
4. Pressure class or thickness	3000, 6000 1/2" - 1 1/2" 9000
5. End connections	NPT Threaded End, Socket weld
6. Size Range (NPS)	1/2" - 1 1/2"
7. Additional requirement	-

Commodity Code	C03-04
Specs	B6 C6 E6 E19 F6
1. Fitting type	Tee, B16.11
2. Material	ASTM A350 Gr LF2 Cl 1
3. Standard	ASME B16.11
4. Pressure class or thickness	3000, 6000, 9000
5. End connections	Socket weld
6. Size Range (NPS)	1/2" - 1 1/2"
7. Additional requirement	-

Commodity Code	C03-27
Specs	B16 C16 E16 G16P G16
1. Fitting type	Tee, B16.11
2. Material	ASTM A182 Gr F51 (UNS S31803)
3. Standard	ASME B16.11
4. Pressure class or thickness	3000
5. End connections	Socket weld
6. Size Range (NPS)	1/2" - 1 1/2"
7. Additional requirement	-

Commodity Code	C03-30
Specs	B12
1. Fitting type	Tee, B16.11
2. Material	ASTM A182 Gr F55 (UNS S32760)
3. Standard	ASME B16.11
4. Pressure class or thickness	3000
5. End connections	Socket weld
6. Size Range (NPS)	1/2" - 1 1/2"
7. Additional requirement	-

Commodity Code	C03-33
Specs	B30 C30 E30
1. Fitting type	Tee, B16.11
2. Material	ASTM B366 (UNS N06625)
3. Standard	ASME B16.11
4. Pressure class or thickness	3000
5. End connections	Socket weld
6. Size Range (NPS)	½" - 1 ½"
7. Additional requirement	-

B12.2.6 REDUCING TEE, B16.11

Commodity Code	C03-35
Specs	B7
1. Fitting type	Tee, B16.11
2. Material	Cu-Ni 90/10 (UNS C7060X)
3. Standard	EEMUA 234
4. Pressure class or thickness	20 bar
5. End connections	Female Capilar
6. Size Range (NPS)	½" - 1 ½"
7. Additional requirement	-

Commodity Code	C03-43
Specs	B3 C3 E3 G3
1. Fitting type	Tee, B16.11
2. Material	ASTM A182 Gr F316/316L
3. Standard	ASME B16.11
4. Pressure class or thickness	3000
5. End connections	Socket weld
6. Size Range (NPS)	½" - 1 ½"
7. Additional requirement	-

Commodity Code	C04-02
Specs	B4 B9 B10 C8 C10 E8 E34 G10
1. Fitting type	Reducing Tee, B16.11
2. Material	ASTM A105
3. Standard	ASME B16.11
4. Pressure class or thickness	3000, 6000, 9000
5. End connections	NPT Threaded End, Socket Weld
6. Size Range (NPS)	¾" - 1 ½"
7. Additional requirement	-
8. Weight	-
9. Dimension	-

Commodity Code	C04-04
Specs	B6 C6 E6 E19 F6
1. Fitting type	Reducing Tee, B16.11
2. Material	ASTM A350 Gr LF2 Cl 1
3. Standard	ASME B16.11
4. Pressure class or thickness	3000, 6000, 9000
5. End connections	Socket weld
6. Size Range (NPS)	¾" - 1 ½"
7. Additional requirement	-
8. Weight	-
9. Dimension	-

Commodity Code	C04-27
Specs	B16 C16 E16 G16P G16
1. Fitting type	Reducing Tee, B16.11
2. Material	ASTM A182 Gr F51 (UNS S31803)
3. Standard	ASME B16.11
4. Pressure class or thickness	3000
5. End connections	Socket weld
6. Size Range (NPS)	¾" - 1 ½"
7. Additional requirement	-
8. Weight	-
9. Dimension	-

Commodity Code	C04-30
Specs	B12
1. Fitting type	Reducing Tee, B16.11
2. Material	ASTM A182 Gr F55 (UNS S32760)
3. Standard	ASME B16.11
4. Pressure class or thickness	3000
5. End connections	Socket weld
6. Size Range (NPS)	¾" - 1 ½"
7. Additional requirement	-
8. Weight	-
9. Dimension	-

Commodity Code	C04-33
Specs	B30 C30 E30
1. Fitting type	Reducing Tee, B16.11
2. Material	ASTM B366 (UNS N06625)
3. Standard	ASME B16.11
4. Pressure class or thickness	3000
5. End connections	Socket weld
6. Size Range (NPS)	¾" - 1 ½"
7. Additional requirement	-
8. Weight	-
9. Dimension	-

Commodity Code	C04-35
Specs	
1. Fitting type	Reducing Tee, B16.11
2. Material	Cu-Ni 90/10 (UNS C7060X)
3. Standard	EEMUA 234
4. Pressure class or thickness	-
5. End connections	-
6. Size Range (NPS)	-
7. Additional requirement	-
8. Weight	-
9. Dimension	-

Commodity Code	C04-43
Specs	B3 C3 E3 G3
1. Fitting type	Reducing Tee, B16.11
2. Material	ASTM A182 Gr F316/316L
3. Standard	ASME B16.11
4. Pressure class or thickness	3000
5. End connections	Socket weld
6. Size Range (NPS)	¾" - 1 ½"
7. Additional requirement	-
8. Weight	-
9. Dimension	-

B12.2.7 CROSS, B16.11

Commodity Code	C05-02
Specs	B4 B9 B10 C8 C10 E8 E34 G10
1. Fitting type	Cross, B16.11
2. Material	ASTM A105
3. Standard	ASME B16.11
4. Pressure class or thickness	3000, 6000, 9000
5. End connections	NPT Threaded End, Socket Weld
6. Size Range (NPS)	¾" - 1 ½"
7. Additional requirement	-
8. Weight	-
9. Dimension	-

Commodity Code	C05-04
Specs	B6 C6 E6 E19 F6
1. Fitting type	Cross, B16.11
2. Material	ASTM A350 Gr LF2 Cl 1
3. Standard	ASME B16.11
4. Pressure class or thickness	3000, 6000, 9000
5. End connections	Socket weld
6. Size Range (NPS)	¾" - 1 ½"
7. Additional requirement	-
8. Weight	-
9. Dimension	-

Commodity Code	C05-27
Specs	B16 C16 E16 G16P G16
1. Fitting type	Cross, B16.11
2. Material	ASTM A182 Gr F51 (UNS S31803)
3. Standard	ASME B16.11
4. Pressure class or thickness	3000
5. End connections	Socket weld
6. Size Range (NPS)	¾" - 1 ½"
7. Additional requirement	-
8. Weight	-
9. Dimension	-

Commodity Code	C05-30
Specs	B12
1. Fitting type	Cross, B16.11
2. Material	ASTM A182 Gr F55 (UNS S32760)
3. Standard	ASME B16.11
4. Pressure class or thickness	3000
5. End connections	Socket weld
6. Size Range (NPS)	¾" - 1 ½"
7. Additional requirement	-
8. Weight	-
9. Dimension	-

Commodity Code	C05-33
Specs	B30 C30 E30
1. Fitting type	Cross, B16.11
2. Material	ASTM B366 (UNS N06625)
3. Standard	ASME B16.11
4. Pressure class or thickness	3000
5. End connections	Socket weld
6. Size Range (NPS)	¾" - 1 ½"
7. Additional requirement	-
8. Weight	-
9. Dimension	-

Commodity Code	C05-43
Specs	B3 C3 E3 G3
1. Fitting type	Cross, B16.11
2. Material	ASTM A182 Gr F316/316L
3. Standard	ASME B16.11
4. Pressure class or thickness	3000
5. End connections	Socket weld
6. Size Range (NPS)	¾" - 1 ½"
7. Additional requirement	-
8. Weight	-
9. Dimension	-

B12.2.8 COUPLING

Commodity Code	C06-02
Specs	B4 B9 B10 C8 C10 E8 E34 G10
1. Fitting type	Coupling
2. Material	ASTM A105
3. Standard	ASME B16.11
4. Pressure class or thickness	3000, 6000, 9000
5. End connections	NPT Threaded End, Socket weld
6. Size Range (NPS)	¾" - 1 ½"
7. Additional requirement	-
8. Weight	-
9. Dimension	-

Commodity Code	C06-04
Specs	B6 C6 E6 E19 F6
1. Fitting type	Coupling
2. Material	ASTM A350 Gr LF2 Cl 1
3. Standard	ASME B16.11
4. Pressure class or thickness	3000, 6000, 9000
5. End connections	Socket weld
6. Size Range (NPS)	¾" - 1 ½"
7. Additional requirement	-
8. Weight	-
9. Dimension	-

Commodity Code	C06-27
Specs	B16 C16 E16 G16P G16
1. Fitting type	Coupling
2. Material	ASTM A182 Gr F51 (UNS S31803)
3. Standard	ASME B16.11
4. Pressure class or thickness	3000
5. End connections	Socket weld
6. Size Range (NPS)	¾" - 1 ½"
7. Additional requirement	-
8. Weight	-
9. Dimension	-

Commodity Code	C06-30
Specs	B12
1. Fitting type	Coupling
2. Material	ASTM A182 Gr F55 (UNS S32760)
3. Standard	ASME B16.11
4. Pressure class or thickness	3000
5. End connections	Socket weld
6. Size Range (NPS)	¾" - 1 ½"
7. Additional requirement	-
8. Weight	-
9. Dimension	-

Commodity Code	C06-33
Specs	B30 C30 E30
1. Fitting type	Coupling
2. Material	ASTM B366 (UNS N06625)
3. Standard	ASME B16.11
4. Pressure class or thickness	3000
5. End connections	Socket weld
6. Size Range (NPS)	¾" - 1 ½"
7. Additional requirement	-
8. Weight	-
9. Dimension	-

Commodity Code	C06-35
Specs	B7
1. Fitting type	Coupling
2. Material	Cu-Ni 90/10 (UNS C7060X)
3. Standard	EEMUA 234
4. Pressure class or thickness	20 bar
5. End connections	Female Capilar
6. Size Range (NPS)	¾" - 1 ½"
7. Additional requirement	-
8. Weight	-
9. Dimension	-

Commodity Code	C06-43
Specs	B3 C3 E3 G3
1. Fitting type	Coupling
2. Material	ASTM A182 Gr F316/316L
3. Standard	ASME B16.11
4. Pressure class or thickness	3000
5. End connections	Socket weld
6. Size Range (NPS)	¾" - 1 ½"
7. Additional requirement	-
8. Weight	-
9. Dimension	-

Commodity Code	C06-52
Specs	B22
1. Fitting type	Coupling
2. Material	FRP - Bisphenol A Epoxy resins reinforced with fiberglass type E or E-CR. Design pressure 10bar@90°C
3. Standard	ISO 14692
4. Pressure class or thickness	10 bar
5. End connections	-
6. Size Range (NPS)	1" - 40"
7. Additional requirement	-
8. Weight	-
9. Dimension	-

Commodity Code	C06-53
Specs	
1. Fitting type	Coupling
2. Material	FRP - Bisphenol A Epoxy vinyl ester resins reinforced with fiberglass type E or E-CR. Design pressure 10bar@90°C.
3. Standard	ISO 14692
4. Pressure class or thickness	-
5. End connections	-
6. Size Range (NPS)	-
7. Additional requirement	-
8. Weight	-
9. Dimension	-

Commodity Code	C06-54
Specs	B23
1. Fitting type	Coupling
2. Material	FRP - Bisphenol A Epoxy resins reinforced with fiberglass type E or E-CR. Design pressure 16bar@90°C
3. Standard	ISO 14692
4. Pressure class or thickness	16 bar
5. End connections	Bell-Spigot
6. Size Range (NPS)	1" - 48"
7. Additional requirement	-
8. Weight	-
9. Dimension	-

Commodity Code	C06-55
Specs	
1. Fitting type	Coupling
2. Material	FRP - Bisphenol A Epoxy vinyl ester resins reinforced with fiberglass type E or E-CR. Design pressure 16bar@90°C.
3. Standard	ISO 14692
4. Pressure class or thickness	16 bar
5. End connections	-
6. Size Range (NPS)	-
7. Additional requirement	-
8. Weight	-
9. Dimension	-

Commodity Code	C06-56
Specs	B26
1. Fitting type	Coupling
2. Material	FRP - Bisphenol A Epoxy resins reinforced with fiberglass type E or E-CR. Design pressure 16bar@120°C
3. Standard	ISO 14692
4. Pressure class or thickness	16 bar
5. End connections	1" - 16"   10 bar, 25 bar
6. Size Range (NPS)	Butt-Strap
7. Additional requirement	1" - 36"
8. Weight	-
9. Dimension	-

Commodity Code	C06-57
Specs	B27
1. Fitting type	Coupling
2. Material	FRP - Epoxy vinyl ester resins (bisphenol A or brominated) reinforced with fiberglass type E-CR, inner liner with fiberglass veils type C. Design pressure 16bar@85°C
3. Standard	ISO 14692
4. Pressure class or thickness	16 bar
5. End connections	-
6. Size Range (NPS)	1" - 6"
7. Additional requirement	-
8. Weight	-
9. Dimension	-

Commodity Code	C06-64
Specs	B28 C23
1. Fitting type	Coupling
2. Material	FRP - Bisphenol A Epoxy resins reinforced with fiberglass type E or E-CR. Design pressure 25bar@90°C
3. Standard	ISO 14692
4. Pressure class or thickness	25 bar
5. End connections	1" - 6"   16 bar
6. Size Range (NPS)	1" - 28"
7. Additional requirement	-
8. Weight	-
9. Dimension	-



B12.2.9 HALF COUPLING, B16.11

Commodity Code	C07-43
Specs	
1. Fitting type	Half Coupling, B16.11
2. Material	ASTM A182 Gr F316/316L
3. Standard	ASME B16.11
4. Pressure class or thickness	-
5. End connections	-
6. Size Range (NPS)	-
7. Additional requirement	-

Commodity Code	C07-50
Specs	
1. Fitting type	Half Coupling, B16.11
2. Material	PVC - ASTM D1784 class 12454
3. Standard	ASTM D2464
4. Pressure class or thickness	-
5. End connections	-
6. Size Range (NPS)	-
7. Additional requirement	-

Commodity Code	C07-51
Specs	
1. Fitting type	Half Coupling, B16.11
2. Material	CPVC - ASTM D1784 class 23447
3. Standard	ASTM F439
4. Pressure class or thickness	-
5. End connections	-
6. Size Range (NPS)	-
7. Additional requirement	-

Commodity Code	C07-52
Specs	
1. Fitting type	Half Coupling, B16.11
2. Material	FRP - Bisphenol A Epoxy resins reinforced with fiberglass type E or E-CR. Design pressure 10bar@90°C
3. Standard	ISO 14692
4. Pressure class or thickness	-
5. End connections	-
6. Size Range (NPS)	-
7. Additional requirement	-

Commodity Code	C07-53
Specs	
1. Fitting type	Half Coupling, B16.11
2. Material	FRP - Bisphenol A Epoxy vinyl ester resins reinforced with fiberglass type E or E-CR. Design pressure 10bar@90°C.
3. Standard	ISO 14692
4. Pressure class or thickness	-
5. End connections	-
6. Size Range (NPS)	-
7. Additional requirement	-

Commodity Code	C07-54
Specs	
1. Fitting type	Half Coupling, B16.11
2. Material	FRP - Bisphenol A Epoxy vinyl ester resins reinforced with fiberglass type E or E-CR. Design pressure 16bar@90°C
3. Standard	ISO 14692
4. Pressure class or thickness	-
5. End connections	-
6. Size Range (NPS)	-
7. Additional requirement	-

Commodity Code	C07-55
Specs	
1. Fitting type	Half Coupling, B16.11
2. Material	FRP - Bisphenol A Epoxy vinyl ester resins reinforced with fiberglass type E or E-CR. Design pressure 16bar@90°C.
3. Standard	ISO 14692
4. Pressure class or thickness	-
5. End connections	-
6. Size Range (NPS)	-
7. Additional requirement	-

Commodity Code	C07-56
Specs	
1. Fitting type	Half Coupling, B16.11
2. Material	FRP - Bisphenol A Epoxy vinyl ester resins reinforced with fiberglass type E or E-CR. Design pressure 16bar@120°C
3. Standard	ISO 14692
4. Pressure class or thickness	-
5. End connections	-
6. Size Range (NPS)	-
7. Additional requirement	-

Commodity Code	C07-57
Specs	
1. Fitting type	Half Coupling, B16.11
2. Material	FRP - Epoxy vinyl ester resins (bisphenol A or brominated) reinforced with fiberglass type E-CR, inner liner with fiberglass veils type C. Design pressure 16bar@85°C
3. Standard	ISO 14692
4. Pressure class or thickness	-
5. End connections	-
6. Size Range (NPS)	-
7. Additional requirement	-

B12.2.10 REDUCING COUPLING, B16.11

Commodity Code	C08-02
Specs	
1. Fitting type	Reducing Coupling, B16.11
2. Material	ASTM A105
3. Standard	ASME B16.11
4. Pressure class or thickness	3000, 6000, 9000
5. End connections	Socket weld NPT Threaded End
6. Size Range (NPS)	1/2" - 1 1/2"
7. Additional requirement	-
8. Weight	-
9. Dimension	-

Commodity Code	C08-04
Specs	
1. Fitting type	Reducing Coupling, B16.11
2. Material	ASTM A350 Gr LF2 Cl 1
3. Standard	ASME B16.11
4. Pressure class or thickness	3000, 6000, 9000
5. End connections	Socket weld NPT Threaded End
6. Size Range (NPS)	1/2" - 1 1/2"
7. Additional requirement	-
8. Weight	-
9. Dimension	-

Commodity Code	C08-27
Specs	
1. Fitting type	Reducing Coupling, B16.11
2. Material	ASTM A182 Gr F51 (UNS S31803)
3. Standard	ASME B16.11
4. Pressure class or thickness	3000
5. End connections	Socket weld NPT Threaded End
6. Size Range (NPS)	1/2" - 1 1/2"
7. Additional requirement	-
8. Weight	-
9. Dimension	-

Commodity Code	C08-30
Specs	
1. Fitting type	Reducing Coupling, B16.11
2. Material	ASTM A182 Gr F55 (UNS S32760)
3. Standard	ASME B16.11
4. Pressure class or thickness	3000
5. End connections	Socket weld NPT Threaded End
6. Size Range (NPS)	1/2" - 1 1/2"
7. Additional requirement	-
8. Weight	-
9. Dimension	-

Commodity Code	C08-33
Specs	
1. Fitting type	Reducing Coupling, B16.11
2. Material	ASTM B366 (UNS N06625)
3. Standard	ASME B16.11
4. Pressure class or thickness	3000
5. End connections	Socket weld NPT Threaded End
6. Size Range (NPS)	1/2" - 1 1/2"
7. Additional requirement	-
8. Weight	-
9. Dimension	-

Commodity Code	C08-35
Specs	
1. Fitting type	Reducing Coupling, B16.11
2. Material	Cu-Ni 90/10 (UNS C7060X)
3. Standard	EEMUA 234
4. Pressure class or thickness	20 bar
5. End connections	Female Capilar, Male x Female Capilar
6. Size Range (NPS)	1/2" - 2"
7. Additional requirement	-
8. Weight	-
9. Dimension	-

Commodity Code	C08-43
Specs	
1. Fitting type	Reducing Coupling, B16.11
2. Material	ASTM A182 Gr F316/316L
3. Standard	ASME B16.11
4. Pressure class or thickness	3000
5. End connections	Socket weld
6. Size Range (NPS)	1/2" - 1 1/2"
7. Additional requirement	-
8. Weight	-
9. Dimension	-

Commodity Code	C08-52
Specs	
1. Fitting type	Reducing Coupling, B16.11
2. Material	FRP - Bisphenol A Epoxy resins reinforced with fiberglass type E or E-CR. Design pressure 10bar@90°C
3. Standard	ISO 14692
4. Pressure class or thickness	-
5. End connections	-
6. Size Range (NPS)	-
7. Additional requirement	-
8. Weight	-
9. Dimension	-

Commodity Code	C08-53
Specs	
1. Fitting type	Reducing Coupling, B16.11
2. Material	FRP - Bisphenol A Epoxy vinyl ester resins reinforced with fiberglass type E or E-CR. Design pressure 10bar@90°C.
3. Standard	ISO 14692
4. Pressure class or thickness	-
5. End connections	-
6. Size Range (NPS)	-
7. Additional requirement	-
8. Weight	-
9. Dimension	-

Commodity Code	C08-54
Specs	
1. Fitting type	Reducing Coupling, B16.11
2. Material	FRP - Bisphenol A Epoxy vinyl ester resins reinforced with fiberglass type E or E-CR. Design pressure 16bar@90°C
3. Standard	ISO 14692
4. Pressure class or thickness	-
5. End connections	-
6. Size Range (NPS)	-
7. Additional requirement	-
8. Weight	-
9. Dimension	-

Commodity Code	C08-55
Specs	
1. Fitting type	Reducing Coupling, B16.11
2. Material	FRP - Bisphenol A Epoxy vinyl ester resins reinforced with fiberglass type E or E-CR. Design pressure 16bar@90°C.
3. Standard	ISO 14692
4. Pressure class or thickness	-
5. End connections	-
6. Size Range (NPS)	-
7. Additional requirement	-
8. Weight	-
9. Dimension	-

Commodity Code	C08-56
Specs	
1. Fitting type	Reducing Coupling, B16.11
2. Material	FRP - Bisphenol A Epoxy vinyl ester resins reinforced with fiberglass type E or E-CR. Design pressure 16bar@120°C
3. Standard	ISO 14692
4. Pressure class or thickness	-
5. End connections	-
6. Size Range (NPS)	-
7. Additional requirement	-
8. Weight	-
9. Dimension	-

Commodity Code	C08-57
Specs	
1. Fitting type	Reducing Coupling, B16.11
2. Material	FRP - Epoxy vinyl ester resins (bisphenol A or brominated) reinforced with fiberglass type E-CR, inner liner with fiberglass veils type C. Design pressure 16bar@85°C
3. Standard	ISO 14692
4. Pressure class or thickness	-
5. End connections	-
6. Size Range (NPS)	-
7. Additional requirement	-
8. Weight	-
9. Dimension	-

B12.2.11 HEX HEAD PLUG, B16.11

Commodity Code	C09-26
Specs	
1. Fitting type	Hex Head Plug, B16.11
2. Material	ASTM A182 Gr F316
3. Standard	ASME B16.11
4. Pressure class or thickness	-
5. End connections	Beveled End
6. Size Range (NPS)	1/2" - 2"
7. Additional requirement	-
8. Weight	-
9. Dimension	-

Commodity Code	C09-35
Specs	
1. Fitting type	Hex Head Plug, B16.11
2. Material	Cu-Ni 90/10 (UNS C7060X)
3. Standard	EEMUA 234
4. Pressure class or thickness	20 bar
5. End connections	NPT Threaded End
6. Size Range (NPS)	1/2" - 1 1/2"
7. Additional requirement	-
8. Weight	-
9. Dimension	-

Commodity Code	C09-36
Specs	
1. Fitting type	Hex Head Plug, B16.11
2. Material	ASTM B62 (UNS C83600)
3. Standard	ASME B16.15
4. Pressure class or thickness	250
5. End connections	NPT Threaded End
6. Size Range (NPS)	1" - 1 1/2"
7. Additional requirement	-
8. Weight	-
9. Dimension	-

B12.2.12 UNION



Commodity Code	C10-02
Specs	C8 E8
1. Fitting type	Union
2. Material	ASTM A105
3. Standard	ASME B16.11
4. Pressure class or thickness	3000
5. End connections	NPT Threaded End , Socket weld
6. Size Range (NPS)	½" - 1 ½"
7. Additional requirement	-
8. Weight	-
9. Dimension	-

B12.2.13 CAP, B16.11

Commodity Code	C10-35
Specs	B7
1. Fitting type	Union
2. Material	Cu-Ni 90/10 (UNS C7060X)
3. Standard	EEMUA 234
4. Pressure class or thickness	20 bar
5. End connections	Female Capilar
6. Size Range (NPS)	½" - 1 ½"
7. Additional requirement	-
8. Weight	-
9. Dimension	-

Commodity Code	C11-02
Specs	B4 B9 B10 C8 C10 E8 E34 G10
1. Fitting type	Cap, B16.11
2. Material	ASTM A105
3. Standard	ASME B16.11
4. Pressure class or thickness	3000, 6000, 9000
5. End connections	NPT Threaded End , Socket weld 1" - 1 ½" Beveled End
6. Size Range (NPS)	½" - 1 ½"
7. Additional requirement	-
8. Weight	-
9. Dimension	-

Commodity Code	C11-04
Specs	B6 C6 E6 E19 F6
1. Fitting type	Cap, B16.11
2. Material	ASTM A350 Gr LF2 Cl 1
3. Standard	ASME B16.11
4. Pressure class or thickness	3000, 6000, 9000
5. End connections	NPT Threaded End , Socket weld
6. Size Range (NPS)	½" - 1 ½"
7. Additional requirement	-
8. Weight	-
9. Dimension	-

Commodity Code	C11-27
Specs	B16 C16 E16 G16P G16
1. Fitting type	Cap, B16.11
2. Material	ASTM A182 Gr F51 (UNS S31803)
3. Standard	ASME B16.11
4. Pressure class or thickness	3000
5. End connections	NPT Threaded End , Socket weld
6. Size Range (NPS)	½" - 1 ½"
7. Additional requirement	-
8. Weight	-
9. Dimension	-

Commodity Code	C11-30
Specs	B12
1. Fitting type	Cap, B16.11
2. Material	ASTM A182 Gr F55 (UNS S32760)
3. Standard	ASME B16.11
4. Pressure class or thickness	3000
5. End connections	NPT Threaded End , Socket weld
6. Size Range (NPS)	½" - 1 ½"
7. Additional requirement	-
8. Weight	-
9. Dimension	-

Commodity Code	C11-33
Specs	B30 C30 E30
1. Fitting type	Cap, B16.11
2. Material	ASTM B366 (UNS N06625)
3. Standard	ASME B16.11
4. Pressure class or thickness	3000
5. End connections	NPT Threaded End , Socket weld
6. Size Range (NPS)	½" - 1 ½"
7. Additional requirement	-
8. Weight	-
9. Dimension	-

Commodity Code	C11-35
Specs	B7
1. Fitting type	Cap, B16.11
2. Material	Cu-Ni 90/10 (UNS C7060X)
3. Standard	EEMUA 234
4. Pressure class or thickness	20 bar
5. End connections	Female Capilar
6. Size Range (NPS)	½" - 1 ½"
7. Additional requirement	-
8. Weight	-
9. Dimension	-

Commodity Code	C11-43
Specs	B3 C3 E3 G3
1. Fitting type	Cap, B16.11
2. Material	ASTM A182 Gr F316/316L
3. Standard	ASME B16.11
4. Pressure class or thickness	3000
5. End connections	Socket weld
6. Size Range (NPS)	½" - 1 ½"
7. Additional requirement	-
8. Weight	-
9. Dimension	-

B12.2.14 WELDOLET

Commodity Code	C12-02
Specs	B4 B9 B10 B11 B14 B30 C8 C10 C11 C30 E8
1. Fitting type	weldolet
2. Material	ASTM A105
3. Standard	MSS SP-97
4. Pressure class or thickness	-
5. End connections	Beveled end
6. Size Range (NPS)	1" - 20"
7. Additional requirement	-
8. Weight	-
9. Dimension	-

Commodity Code	C12-04
Specs	B6 C6 E6 E19 F6
1. Fitting type	weldolet
2. Material	ASTM A350 Gr LF2 Cl 1
3. Standard	MSS SP-97
4. Pressure class or thickness	-
5. End connections	Beveled end
6. Size Range (NPS)	1" - 50"
7. Additional requirement	-
8. Weight	-
9. Dimension	-

Commodity Code	C12-22
Specs	E30 E34 G10 H30
1. Fitting type	weldolet
2. Material	ASTM A694 Gr F65
3. Standard	MSS SP-97
4. Pressure class or thickness	-
5. End connections	Beveled end
6. Size Range (NPS)	1" - 16"
7. Additional requirement	-
8. Weight	-
9. Dimension	-

Commodity Code	C12-27
Specs	B16 C16 E16 G16P G16 H16
1. Fitting type	weldolet
2. Material	ASTM A182 Gr F51 (UNS S31803)
3. Standard	MSS SP-97
4. Pressure class or thickness	-
5. End connections	Beveled end
6. Size Range (NPS)	1" - 18"
7. Additional requirement	-
8. Weight	-
9. Dimension	-

Commodity Code	C12-30
Specs	B12 H12P H12
1. Fitting type	weldolet
2. Material	ASTM A182 Gr F55 (UNS S32760)
3. Standard	MSS SP-97
4. Pressure class or thickness	-
5. End connections	Beveled end
6. Size Range (NPS)	1" - 16"
7. Additional requirement	-
8. Weight	-
9. Dimension	-

Commodity Code	C12-33
Specs	B30 C30 E30 H30
1. Fitting type	weldolet
2. Material	ASTM B366 (UNS N06625)
3. Standard	MSS SP-97
4. Pressure class or thickness	-
5. End connections	Beveled end
6. Size Range (NPS)	1" - 14"
7. Additional requirement	-
8. Weight	-
9. Dimension	-

Commodity Code	C12-35
Specs	B7
1. Fitting type	weldolet
2. Material	Cu-Ni 90/10 (UNS C7060X)
3. Standard	EEMUA 234
4. Pressure class or thickness	-
5. End connections	Beveled end
6. Size Range (NPS)	2" - 16"
7. Additional requirement	-
8. Weight	-
9. Dimension	-

Commodity Code	C12-43
Specs	B3 C3 E3 G3 H3
1. Fitting type	weldolet
2. Material	ASTM A182 Gr F316/316L
3. Standard	MSS SP-97
4. Pressure class or thickness	-
5. End connections	Beveled end
6. Size Range (NPS)	1" - 20"
7. Additional requirement	-
8. Weight	-
9. Dimension	-

B12.2.15 LONG RADIUS 90 DEG ELBOW

Commodity Code	C15-03
Specs	B4 B9 B10 B11 B14 B30 C8 C10 C11 C30 E8
1. Fitting type	Long Radius 90 deg Elbow
2. Material	ASTM A234 Gr WPB
3. Standard	ASME B16.9
4. Pressure class or thickness	-
5. End connections	Beveled End
6. Size Range (NPS)	1" - 44"
7. Additional requirement	-
8. Weight	-
9. Dimension	-

Commodity Code	C15-05
Specs	B6 C6 E6 E19 F6
1. Fitting type	Long Radius 90 deg Elbow
2. Material	ASTM A420 Gr WPL6
3. Standard	ASME B16.9
4. Pressure class or thickness	-
5. End connections	Beveled End
6. Size Range (NPS)	1" - 40"
7. Additional requirement	-
8. Weight	-
9. Dimension	-

Commodity Code	C15-22
Specs	E30 E34 G10 H30
1. Fitting type	Long Radius 90 deg Elbow
2. Material	ASTM A860 WPHY65
3. Standard	MSS SP-75
4. Pressure class or thickness	-
5. End connections	Beveled End
6. Size Range (NPS)	1" - 24"
7. Additional requirement	-
8. Weight	-
9. Dimension	-

Commodity Code	C15-29
Specs	B16 C16 E16 G16P G16 H16
1. Fitting type	Long Radius 90 deg Elbow
2. Material	ASTM A815 (UNS S31803)
3. Standard	ASME B16.9
4. Pressure class or thickness	-
5. End connections	Beveled End
6. Size Range (NPS)	1" - 40"
7. Additional requirement	-
8. Weight	-
9. Dimension	-

Commodity Code	C15-32
Specs	B12 H12P H12
1. Fitting type	Long Radius 90 deg Elbow
2. Material	ASTM A815 (UNS S32760)
3. Standard	ASME B16.9
4. Pressure class or thickness	-
5. End connections	Beveled End
6. Size Range (NPS)	1" - 36"
7. Additional requirement	-
8. Weight	-
9. Dimension	-

Commodity Code	C15-33
Specs	B30 C30 E30 H30
1. Fitting type	Long Radius 90 deg Elbow
2. Material	ASTM B366 (UNS N06625)
3. Standard	ASME B16.9
4. Pressure class or thickness	-
5. End connections	Beveled End
6. Size Range (NPS)	1" - 14"
7. Additional requirement	-
8. Weight	-
9. Dimension	-

Commodity Code	C15-35
Specs	B7
1. Fitting type	Long Radius 90 deg Elbow
2. Material	Cu-Ni 90/10 (UNS C7060X)
3. Standard	EEMUA 234
4. Pressure class or thickness	-
5. End connections	Beveled End
6. Size Range (NPS)	2" - 36"
7. Additional requirement	-
8. Weight	-
9. Dimension	-

Commodity Code	C15-44
Specs	B3 C3 E3 G3 H3
1. Fitting type	Long Radius 90 deg Elbow
2. Material	ASTM A403 Gr WP316/316L
3. Standard	ASME B16.9
4. Pressure class or thickness	-
5. End connections	Beveled End
6. Size Range (NPS)	1" - 44"
7. Additional requirement	-
8. Weight	-
9. Dimension	-

Commodity Code	C15-52
Specs	B22
1. Fitting type	Long Radius 90 deg Elbow
2. Material	FRP - Bisphenol A Epoxy resins reinforced with fiberglass type E or E-CR. Design pressure 10bar@90°C
3. Standard	ISO 14692
4. Pressure class or thickness	10 bar
5. End connections	Bell-Spigot, Butt-Strap
6. Size Range (NPS)	1" - 44"
7. Additional requirement	-
8. Weight	-
9. Dimension	-

Commodity Code	C15-53
Specs	B22
1. Fitting type	Long Radius 90 deg Elbow
2. Material	FRP - Bisphenol A Epoxy vinyl ester resins reinforced with fiberglass type E or E-CR. Design pressure 10bar@90°C
3. Standard	ISO 14692
4. Pressure class or thickness	-
5. End connections	-
6. Size Range (NPS)	-
7. Additional requirement	-
8. Weight	-
9. Dimension	-

Commodity Code	C15-54
Specs	B23
1. Fitting type	Long Radius 90 deg Elbow
2. Material	FRP - Bisphenol A Epoxy resins reinforced with fiberglass type E or E-CR. Design pressure 16bar@90°C
3. Standard	ISO 14692
4. Pressure class or thickness	16 bar
5. End connections	Butt-Strap 1" - 48"   Bell-Spigot
6. Size Range (NPS)	1" - 64"
7. Additional requirement	-
8. Weight	-
9. Dimension	-

Commodity Code	C15-55
Specs	B23
1. Fitting type	Long Radius 90 deg Elbow
2. Material	FRP - Bisphenol A Epoxy vinyl ester resins reinforced with fiberglass type E or E-CR. Design pressure 16bar@90°C
3. Standard	ISO 14692
4. Pressure class or thickness	-
5. End connections	-
6. Size Range (NPS)	-
7. Additional requirement	-
8. Weight	-
9. Dimension	-

Commodity Code	C15-56
Specs	B26
1. Fitting type	Long Radius 90 deg Elbow
2. Material	FRP - Bisphenol A Epoxy resins reinforced with fiberglass type E or E-CR. Design pressure 16bar@120°C
3. Standard	ISO 14692
4. Pressure class or thickness	16 bar
5. End connections	Butt-Strap
6. Size Range (NPS)	1" - 36"
7. Additional requirement	-
8. Weight	-
9. Dimension	-

Commodity Code	C15-57
Specs	B27
1. Fitting type	Long Radius 90 deg Elbow
2. Material	FRP - Epoxy vinyl ester resins (Bisphenol A or brominated) reinforced with fiberglass type E-CR, inner liner with fiberglass veils type C. Design pressure 16bar@85°C
3. Standard	ISO 14692
4. Pressure class or thickness	16 bar
5. End connections	Butt-Strap
6. Size Range (NPS)	1" - 6"
7. Additional requirement	-
8. Weight	-
9. Dimension	-

Commodity Code	C15-58
Specs	
1. Fitting type	Long Radius 90 deg Elbow
2. Material	RPVC - Glass fiber reinforced PVC
3. Standard	according to manufacturer
4. Pressure class or thickness	-
5. End connections	-
6. Size Range (NPS)	-
7. Additional requirement	-
8. Weight	-
9. Dimension	-

Commodity Code	C15-59
Specs	
1. Fitting type	Long Radius 90 deg Elbow
2. Material	RPVC - Glass fiber reinforced PVC
3. Standard	according to manufacturer
4. Pressure class or thickness	-
5. End connections	-
6. Size Range (NPS)	-
7. Additional requirement	-
8. Weight	-
9. Dimension	-

Commodity Code	C15-60
Specs	
1. Fitting type	Long Radius 90 deg Elbow
2. Material	RPVC - Glass fiber reinforced PVC
3. Standard	according to manufacturer
4. Pressure class or thickness	-
5. End connections	-
6. Size Range (NPS)	-
7. Additional requirement	-
8. Weight	-
9. Dimension	-

Commodity Code	C15-64
Specs	B28 C23
1. Fitting type	Long Radius 90 deg Elbow
2. Material	FRP - Bisphenol A Epoxy resins reinforced with fiberglass type E or E-CR. Design pressure 25bar@90°C
3. Standard	ISO 14692
4. Pressure class or thickness	25 bar
5. End connections	Butt-Strap
6. Size Range (NPS)	1" - 28"
7. Additional requirement	-
8. Weight	-
9. Dimension	-

B12.2.16 LONG RADIUS 45 DEG ELBOW

Commodity Code	C16-03
Specs	B4 B9 B10 B11 B14 B30 C8 C10 C11 C30 E8
1. Fitting type	Long Radius 45 deg Elbow
2. Material	ASTM A234 Gr WPB
3. Standard	ASME B16.9
4. Pressure class or thickness	-
5. End connections	Beveled End
6. Size Range (NPS)	1" - 44"
7. Additional requirement	-

Commodity Code	C16-05
Specs	B6 C6 E6 E19 F6
1. Fitting type	Long Radius 45 deg Elbow
2. Material	ASTM A420 Gr WPL6
3. Standard	ASME B16.9
4. Pressure class or thickness	-
5. End connections	Beveled End
6. Size Range (NPS)	1" - 40"
7. Additional requirement	-

Commodity Code	C16-22
Specs	E30 E34 G10 H30
1. Fitting type	Long Radius 45 deg Elbow
2. Material	ASTM A860 WPHY65
3. Standard	MSS SP-75
4. Pressure class or thickness	""
5. End connections	Beveled End
6. Size Range (NPS)	1" - 24"
7. Additional requirement	-

Commodity Code	C16-29
Specs	B16 C16 E16 G16P G16 H16
1. Fitting type	Long Radius 45 deg Elbow
2. Material	ASTM A815 (UNS S31803)
3. Standard	ASME B16.9
4. Pressure class or thickness	-
5. End connections	Beveled End
6. Size Range (NPS)	1" - 40"
7. Additional requirement	-

Commodity Code	C16-32
Specs	B12 H12P H12
1. Fitting type	Long Radius 45 deg Elbow
2. Material	ASTM A815 (UNS S32760)
3. Standard	ASME B16.9
4. Pressure class or thickness	-
5. End connections	Beveled End
6. Size Range (NPS)	1" - 36"
7. Additional requirement	-

Commodity Code	C16-33
Specs	B30 C30 E30 H30
1. Fitting type	Long Radius 45 deg Elbow
2. Material	ASTM B366 (UNS N06625)
3. Standard	ASME B16.9
4. Pressure class or thickness	-
5. End connections	Beveled End
6. Size Range (NPS)	1" - 14"
7. Additional requirement	-

Commodity Code	C16-35
Specs	B7
1. Fitting type	Long Radius 45 deg Elbow
2. Material	Cu-Ni 90/10 (UNS C7060X)
3. Standard	EEMUA 234
4. Pressure class or thickness	-
5. End connections	Beveled End
6. Size Range (NPS)	2" - 36"
7. Additional requirement	-

Commodity Code	C16-44
Specs	B3 C3 E3 G3 H3
1. Fitting type	Long Radius 45 deg Elbow
2. Material	ASTM A403 Gr WP316/316L
3. Standard	ASME B16.9
4. Pressure class or thickness	-
5. End connections	Beveled End
6. Size Range (NPS)	1" - 44"
7. Additional requirement	-

Commodity Code	C16-52
Specs	B22
1. Fitting type	Long Radius 45 deg Elbow
2. Material	FRP - Bisphenol A Epoxy resins reinforced with fiberglass type E or E-CR. Design pressure 10bar@90°C
3. Standard	ISO 14692
4. Pressure class or thickness	10 bar
5. End connections	Bell-Spigot, Butt-Strap
6. Size Range (NPS)	1" - 44"
7. Additional requirement	-

Commodity Code	C16-53
Specs	
1. Fitting type	Long Radius 45 deg Elbow
2. Material	FRP - Bisphenol A Epoxy vinyl ester resins reinforced with fiberglass type E or E-CR. Design pressure 10bar@90°C.
3. Standard	ISO 14692
4. Pressure class or thickness	-
5. End connections	-
6. Size Range (NPS)	-
7. Additional requirement	-

Commodity Code	C16-54
Specs	B23
1. Fitting type	Long Radius 45 deg Elbow
2. Material	FRP - Bisphenol A Epoxy vinyl ester resins reinforced with fiberglass type E or E-CR. Design pressure 16bar@90°C
3. Standard	ISO 14692
4. Pressure class or thickness	16 bar
5. End connections	Butt-Strap
6. Size Range (NPS)	1" - 60"
7. Additional requirement	-

Commodity Code	C16-55
Specs	
1. Fitting type	Long Radius 45 deg Elbow
2. Material	FRP - Bisphenol A Epoxy vinyl ester resins reinforced with fiberglass type E or E-CR. Design pressure 16bar@90°C.
3. Standard	ISO 14692
4. Pressure class or thickness	-
5. End connections	-
6. Size Range (NPS)	-
7. Additional requirement	-

Commodity Code	C16-56
Specs	B26
1. Fitting type	Long Radius 45 deg Elbow
2. Material	FRP - Bisphenol A Epoxy resins reinforced with fiberglass type E or E-CR. Design pressure 16bar@120°C
3. Standard	ISO 14692
4. Pressure class or thickness	16 bar
5. End connections	Butt-Strap
6. Size Range (NPS)	1" - 36"
7. Additional requirement	-

Commodity Code	C16-57
Specs	B27
1. Fitting type	Long Radius 45 deg Elbow
2. Material	FRP - Epoxy vinyl ester resins (Bisphenol A or brominated) reinforced with fiberglass type E-CR, inner liner with fiberglass veils type C. Design pressure 16bar@85°C
3. Standard	ISO 14692
4. Pressure class or thickness	16 bar
5. End connections	Butt-Strap
6. Size Range (NPS)	1" - 6"
7. Additional requirement	-

Commodity Code	C16-58
Specs	
1. Fitting type	Long Radius 45 deg Elbow
2. Material	RPVC - Glass fiber reinforced PVC
3. Standard	according to manufacturer
4. Pressure class or thickness	-
5. End connections	-
6. Size Range (NPS)	-
7. Additional requirement	-

Commodity Code	C16-59
Specs	
1. Fitting type	Long Radius 45 deg Elbow
2. Material	RPVC - Glass fiber reinforced PVC
3. Standard	according to manufacturer
4. Pressure class or thickness	-
5. End connections	-
6. Size Range (NPS)	-
7. Additional requirement	-

Commodity Code	C16-60
Specs	
1. Fitting type	Long Radius 45 deg Elbow
2. Material	RPVC - Glass fiber reinforced PVC
3. Standard	according to manufacturer
4. Pressure class or thickness	-
5. End connections	-
6. Size Range (NPS)	-
7. Additional requirement	-

Commodity Code	C16-64
Specs	B28 C23
1. Fitting type	Long Radius 45 deg Elbow
2. Material	FRP - Bisphenol A Epoxy resins reinforced with fiberglass type E or E-CR. Design pressure 25bar@90°C
3. Standard	ISO 14692
4. Pressure class or thickness	25 bar
5. End connections	Butt-Strap
6. Size Range (NPS)	1" - 28"
7. Additional requirement	-

B12.2.17 SHORT RADIUS 90 DEG ELBOW

Commodity Code	C17-03
Specs	B4 B9 B10 B11 B14 B30 C8 C10 C11 C30 E8
1. Fitting type	Short radius 90 deg Elbow
2. Material	ASTM A234 Gr WPB
3. Standard	ASME B16.9
4. Pressure class or thickness	-
5. End connections	Beveled End
6. Size Range (NPS)	1" - 44"
7. Additional requirement	-
8. Weight	-
9. Dimension	-

Commodity Code	C17-05
Specs	B6 C6 E6 E19 F6
1. Fitting type	Short radius 90 deg Elbow
2. Material	ASTM A420 Gr WPL6
3. Standard	ASME B16.9
4. Pressure class or thickness	-
5. End connections	Beveled End
6. Size Range (NPS)	1" - 40"
7. Additional requirement	-
8. Weight	-
9. Dimension	-

Commodity Code	C17-22
Specs	E30 E34 G10 H30
1. Fitting type	Short radius 90 deg Elbow
2. Material	ASTM A860 WPHY65
3. Standard	MSS SP-75
4. Pressure class or thickness	""
5. End connections	Beveled End
6. Size Range (NPS)	1" - 24"
7. Additional requirement	-
8. Weight	-
9. Dimension	-

Commodity Code	C17-29
Specs	B16 C16 E16 G16P G16 H16
1. Fitting type	Short radius 90 deg Elbow
2. Material	ASTM A815 (UNS S31803)
3. Standard	ASME B16.9
4. Pressure class or thickness	-
5. End connections	Beveled End
6. Size Range (NPS)	1" - 40"
7. Additional requirement	-
8. Weight	-
9. Dimension	-

Commodity Code	C17-32
Specs	B12 H12P H12
1. Fitting type	Short radius 90 deg Elbow
2. Material	ASTM A815 (UNS S32760)
3. Standard	ASME B16.9
4. Pressure class or thickness	-
5. End connections	Beveled End
6. Size Range (NPS)	1" - 36"
7. Additional requirement	-
8. Weight	-
9. Dimension	-

B12.2.18 CONCENTRIC REDUCING

Commodity Code	C17-33
Specs	B30 C30 E30 H30
1. Fitting type	Short radius 90 deg Elbow
2. Material	ASTM B366 (UNS N06625)
3. Standard	ASME B16.9
4. Pressure class or thickness	-
5. End connections	Beveled End
6. Size Range (NPS)	1" - 14"
7. Additional requirement	-
8. Weight	-
9. Dimension	-

Commodity Code	C17-44
Specs	B3 C3 E3 G3 H3
1. Fitting type	Short radius 90 deg Elbow
2. Material	ASTM A403 Gr WP316/316L
3. Standard	ASME B16.9
4. Pressure class or thickness	-
5. End connections	Beveled End
6. Size Range (NPS)	1" - 44"
7. Additional requirement	-
8. Weight	-
9. Dimension	-

Commodity Code	C18-03
Specs	B4 B9 B10 B11 B14 B30 C8 C10 C11 C30 E8
1. Fitting type	Concentric Reducing
2. Material	ASTM A234 Gr WPB
3. Standard	ASME B16.9
4. Pressure class or thickness	-
5. End connections	Beveled end
6. Size Range (NPS)	1 1/2" - 44"
7. Additional requirement	-
8. Weight	-
9. Dimension	-

Commodity Code	C18-05
Specs	B6 C6 E6 E19 F6
1. Fitting type	Concentric Reducing
2. Material	ASTM A420 Gr WPL6
3. Standard	ASME B16.9
4. Pressure class or thickness	-
5. End connections	Beveled end
6. Size Range (NPS)	1 1/2" - 44"
7. Additional requirement	-
8. Weight	-
9. Dimension	-

Commodity Code	C18-22
Specs	E30 E34 G10 H30
1. Fitting type	Concentric Reducing
2. Material	ASTM A860 WPHY65
3. Standard	MSS SP-75
4. Pressure class or thickness	-
5. End connections	Beveled end
6. Size Range (NPS)	1 1/2" - 24"
7. Additional requirement	-
8. Weight	-
9. Dimension	-

Commodity Code	C18-29
Specs	B16 C16 E16 G16P G16 H16
1. Fitting type	Concentric Reducing
2. Material	ASTM A815 (UNS S31803)
3. Standard	ASME B16.9
4. Pressure class or thickness	-
5. End connections	Beveled end
6. Size Range (NPS)	1 1/2" - 40"
7. Additional requirement	-
8. Weight	-
9. Dimension	-

Commodity Code	C18-32
Specs	B12 H12P H12
1. Fitting type	Concentric Reducing
2. Material	ASTM A815 (UNS S32760)
3. Standard	ASME B16.9
4. Pressure class or thickness	-
5. End connections	Beveled end
6. Size Range (NPS)	1 1/2" - 44"
7. Additional requirement	-
8. Weight	-
9. Dimension	-

Commodity Code	C18-33
Specs	B30 C30 E30 H30
1. Fitting type	Concentric Reducing
2. Material	ASTM B366 (UNS N06625)
3. Standard	ASME B16.9
4. Pressure class or thickness	-
5. End connections	Beveled end
6. Size Range (NPS)	1 1/2" - 14"
7. Additional requirement	-
8. Weight	-
9. Dimension	-

Commodity Code	C18-35
Specs	B7
1. Fitting type	Concentric Reducing
2. Material	Cu-Ni 90/10 (UNS C7060X)
3. Standard	EEMUA 234
4. Pressure class or thickness	-
5. End connections	Beveled end
6. Size Range (NPS)	3" - 36"
7. Additional requirement	-
8. Weight	-
9. Dimension	-

Commodity Code	C18-44
Specs	B3 C3 E3 G3 H3
1. Fitting type	Concentric Reducing
2. Material	ASTM A403 Gr WP316/316L
3. Standard	ASME B16.9
4. Pressure class or thickness	-
5. End connections	Beveled end
6. Size Range (NPS)	2" - 44"
7. Additional requirement	-
8. Weight	-
9. Dimension	-

B12.2.19 ECCENTRIC REDUCING

Commodity Code	C19-03
Specs	B4 B9 B10 B11 B14 B30 C8 C10 C11 C30 E8
1. Fitting type	Eccentric Reducing
2. Material	ASTM A234 Gr WPB
3. Standard	ASME B16.9
4. Pressure class or thickness	-
5. End connections	Beveled end
6. Size Range (NPS)	1 1/2" - 44"
7. Additional requirement	-
8. Weight	-
9. Dimension	-

Commodity Code	C19-05
Specs	B6 C6 E6 E19 F6
1. Fitting type	Eccentric Reducing
2. Material	ASTM A420 Gr WPL6
3. Standard	ASME B16.9
4. Pressure class or thickness	-
5. End connections	Beveled end
6. Size Range (NPS)	1 1/2" - 44"
7. Additional requirement	-
8. Weight	-
9. Dimension	-

Commodity Code	C19-22
Specs	E30 E34 G10 H30
1. Fitting type	Eccentric Reducing
2. Material	ASTM A860 WPHY65
3. Standard	MSS SP-75
4. Pressure class or thickness	-
5. End connections	Beveled end
6. Size Range (NPS)	1 1/2" - 24"
7. Additional requirement	-
8. Weight	-
9. Dimension	-

Commodity Code	C19-29
Specs	B16 C16 E16 G16P G16 H16
1. Fitting type	Eccentric Reducing
2. Material	ASTM A815 (UNS S31803)
3. Standard	ASME B16.9
4. Pressure class or thickness	-
5. End connections	Beveled end
6. Size Range (NPS)	1 1/2" - 40"
7. Additional requirement	-
8. Weight	-
9. Dimension	-

Commodity Code	C19-32
Specs	B12 H12P H12
1. Fitting type	Eccentric Reducing
2. Material	ASTM A815 (UNS S32760)
3. Standard	ASME B16.9
4. Pressure class or thickness	-
5. End connections	Beveled end
6. Size Range (NPS)	1 1/2" - 36"
7. Additional requirement	-
8. Weight	-
9. Dimension	-

Commodity Code	C19-33
Specs	B30 C30 E30 H30
1. Fitting type	Eccentric Reducing
2. Material	ASTM B366 (UNS N06625)
3. Standard	ASME B16.9
4. Pressure class or thickness	-
5. End connections	Beveled end
6. Size Range (NPS)	1 1/2" - 14"
7. Additional requirement	-
8. Weight	-
9. Dimension	-

Commodity Code	C19-35
Specs	B7
1. Fitting type	Eccentric Reducing
2. Material	Cu-Ni 90/10 (UNS C7060X)
3. Standard	EEMUA 234
4. Pressure class or thickness	-
5. End connections	Beveled end
6. Size Range (NPS)	3" - 36"
7. Additional requirement	-
8. Weight	-
9. Dimension	-

Commodity Code	C19-44
Specs	B3 C3 E3 G3 H3
1. Fitting type	Eccentric Reducing
2. Material	ASTM A403 Gr WP316/316L
3. Standard	ASME B16.9
4. Pressure class or thickness	-
5. End connections	Beveled end
6. Size Range (NPS)	2" - 44"
7. Additional requirement	-
8. Weight	-
9. Dimension	-

B12.2.20 TEE

Commodity Code	C20-03
Specs	B4 B9 B10 B11 B14 B30 C8 C10 C11 C30 E8
1. Fitting type	Tee
2. Material	ASTM A234 Gr WPB
3. Standard	ASME B16.9
4. Pressure class or thickness	-
5. End connections	Beveled End
6. Size Range (NPS)	1" - 44"
7. Additional requirement	-
8. Weight	-
9. Dimension	-

Commodity Code	C20-05
Specs	B6 C6 E6 E19 F6
1. Fitting type	Tee
2. Material	ASTM A420 Gr WPL6
3. Standard	ASME B16.9
4. Pressure class or thickness	-
5. End connections	Beveled End
6. Size Range (NPS)	1" - 40"
7. Additional requirement	-
8. Weight	-
9. Dimension	-

Commodity Code	C20-22
Specs	E30 E34 G10 H30
1. Fitting type	Tee
2. Material	ASTM A860 WPHY65
3. Standard	MSS SP-75
4. Pressure class or thickness	-
5. End connections	Beveled End
6. Size Range (NPS)	1" - 34"
7. Additional requirement	-
8. Weight	-
9. Dimension	-

Commodity Code	C20-29
Specs	B16 C16 E16 G16P G16 H16
1. Fitting type	Tee
2. Material	ASTM A815 (UNS S31803)
3. Standard	ASME B16.9
4. Pressure class or thickness	-
5. End connections	Beveled End
6. Size Range (NPS)	1" - 40"
7. Additional requirement	-
8. Weight	-
9. Dimension	-

Commodity Code	C20-32
Specs	B12 H12P H12
1. Fitting type	Tee
2. Material	ASTM A815 (UNS S32760)
3. Standard	ASME B16.9
4. Pressure class or thickness	-
5. End connections	Beveled End
6. Size Range (NPS)	1" - 36"
7. Additional requirement	-
8. Weight	-
9. Dimension	-

Commodity Code	C20-33
Specs	B30 C30 E30 H30
1. Fitting type	Tee
2. Material	ASTM B366 (UNS N06625)
3. Standard	ASME B16.9
4. Pressure class or thickness	-
5. End connections	Beveled End
6. Size Range (NPS)	1" - 14"
7. Additional requirement	-
8. Weight	-
9. Dimension	-

Commodity Code	C20-35
Specs	B7
1. Fitting type	Tee
2. Material	Cu-Ni 90/10 (UNS C7060X)
3. Standard	EEMUA 234
4. Pressure class or thickness	-
5. End connections	Beveled End
6. Size Range (NPS)	2" - 36"
7. Additional requirement	-
8. Weight	-
9. Dimension	-

Commodity Code	C20-44
Specs	B3 C3 E3 G3 H3
1. Fitting type	Tee
2. Material	ASTM A403 Gr WP316/316L
3. Standard	ASME B16.9
4. Pressure class or thickness	-
5. End connections	Beveled End
6. Size Range (NPS)	2" - 44"
7. Additional requirement	-
8. Weight	-
9. Dimension	-

Commodity Code	C20-50
Specs	
1. Fitting type	Tee
2. Material	PVC - ASTM D1784 class 12454
3. Standard	ASTM D2464
4. Pressure class or thickness	-
5. End connections	-
6. Size Range (NPS)	-
7. Additional requirement	-
8. Weight	-
9. Dimension	-

Commodity Code	C20-51
Specs	
1. Fitting type	Tee
2. Material	CPVC - ASTM D1784 class 23447
3. Standard	ASTM F439
4. Pressure class or thickness	-
5. End connections	-
6. Size Range (NPS)	-
7. Additional requirement	-
8. Weight	-
9. Dimension	-

Commodity Code	C20-52
Specs	B22
1. Fitting type	Tee
2. Material	FRP - Bisphenol A Epoxy resins reinforced with fiberglass type E or E-CR. Design pressure 10bar@90°C
3. Standard	ISO 14692
4. Pressure class or thickness	10 bar
5. End connections	Bell-Spigot, Butt-Strap
6. Size Range (NPS)	1" - 40"
7. Additional requirement	-
8. Weight	-
9. Dimension	-

Commodity Code	C20-53
Specs	
1. Fitting type	Tee
2. Material	FRP - Bisphenol A Epoxy vinyl ester resins reinforced with fiberglass type E or E-CR. Design pressure 10bar@90°C.
3. Standard	ISO 14692
4. Pressure class or thickness	-
5. End connections	-
6. Size Range (NPS)	-
7. Additional requirement	-
8. Weight	-
9. Dimension	-

Commodity Code	C20-54
Specs	B23
1. Fitting type	Tee
2. Material	FRP - Bisphenol A Epoxy resins reinforced with fiberglass type E or E-CR. Design pressure 16bar@90°C
3. Standard	ISO 14692
4. Pressure class or thickness	16 bar
5. End connections	Bell-Spigot, Butt-Strap
6. Size Range (NPS)	1" - 48"
7. Additional requirement	-
8. Weight	-
9. Dimension	-

Commodity Code	C20-55
Specs	
1. Fitting type	Tee
2. Material	FRP - Bisphenol A Epoxy vinyl ester resins reinforced with fiberglass type E or E-CR. Design pressure 16bar@90°C.
3. Standard	ISO 14692
4. Pressure class or thickness	-
5. End connections	-
6. Size Range (NPS)	-
7. Additional requirement	-
8. Weight	-
9. Dimension	-

Commodity Code	C20-56
Specs	B26
1. Fitting type	Tee
2. Material	FRP - Bisphenol A Epoxy resins reinforced with fiberglass type E or E-CR. Design pressure 16bar@120°C
3. Standard	ISO 14692
4. Pressure class or thickness	16 bar
5. End connections	Butt-Strap
6. Size Range (NPS)	1" - 36"
7. Additional requirement	-



Commodity Code	C20-64
Specs	B28 C23
1. Fitting type	Tee
2. Material	FRP - Bisphenol A Epoxy resins reinforced with fiberglass type E or E-CR. Design pressure 25bar@90°C
3. Standard	ISO 14692
4. Pressure class or thickness	25 bar
5. End connections	Butt-Strap
6. Size Range (NPS)	1" - 28"
7. Additional requirement	-
8. Weight	-
9. Dimension	-

B12.2.21 REDUCING TEE

Commodity Code	C21-03
Specs	B4 B9 B10 B11 B14 B30 C8 C10 C11 C30 E8
1. Fitting type	Reducing Tee
2. Material	ASTM A234 Gr WPB
3. Standard	ASME B16.9
4. Pressure class or thickness	-
5. End connections	Beveled end
6. Size Range (NPS)	1 1/2" - 44"
7. Additional requirement	-
8. Weight	-
9. Dimension	-

Commodity Code	C21-05
Specs	B6 C6 E6 E19 F6
1. Fitting type	Reducing Tee
2. Material	ASTM A420 Gr WPL6
3. Standard	ASME B16.9
4. Pressure class or thickness	-
5. End connections	Beveled end
6. Size Range (NPS)	1 1/2" - 40"
7. Additional requirement	-
8. Weight	-
9. Dimension	-

Commodity Code	C21-22
Specs	E30 E34 G10 H30
1. Fitting type	Reducing Tee
2. Material	ASTM A860 WPHY65
3. Standard	MSS SP-75
4. Pressure class or thickness	-
5. End connections	Beveled end
6. Size Range (NPS)	1 1/2" - 34"
7. Additional requirement	-
8. Weight	-
9. Dimension	-

Commodity Code	C21-29
Specs	B16 C16 E16 G16P G16 H16
1. Fitting type	Reducing Tee
2. Material	ASTM A815 (UNS S31803)
3. Standard	ASME B16.9
4. Pressure class or thickness	-
5. End connections	Beveled end
6. Size Range (NPS)	2" - 40"
7. Additional requirement	-
8. Weight	-
9. Dimension	-

Commodity Code	C21-32
Specs	B12 H12P H12
1. Fitting type	Reducing Tee
2. Material	ASTM A815 (UNS S32760)
3. Standard	ASME B16.9
4. Pressure class or thickness	-
5. End connections	Beveled end
6. Size Range (NPS)	1 1/2" - 36"
7. Additional requirement	-
8. Weight	-
9. Dimension	-

Commodity Code	C21-33
Specs	B30 C30 E30 H30
1. Fitting type	Reducing Tee
2. Material	ASTM B366 (UNS N06625)
3. Standard	ASME B16.9
4. Pressure class or thickness	-
5. End connections	Beveled end
6. Size Range (NPS)	1 1/2" - 14"
7. Additional requirement	-
8. Weight	-
9. Dimension	-

Commodity Code	C21-35
Specs	B7
1. Fitting type	Reducing Tee
2. Material	Cu-Ni 90/10 (UNS C7060X)
3. Standard	EEMUA 234
4. Pressure class or thickness	-
5. End connections	Beveled end
6. Size Range (NPS)	3" - 36"
7. Additional requirement	-
8. Weight	-
9. Dimension	-

Commodity Code	C21-44
Specs	B3 C3 E3 G3 H3
1. Fitting type	Reducing Tee
2. Material	ASTM A403 Gr WP316/316L
3. Standard	ASME B16.9
4. Pressure class or thickness	-
5. End connections	Beveled end
6. Size Range (NPS)	1 1/2" - 44"
7. Additional requirement	-
8. Weight	-
9. Dimension	-

B12.2.22 CAP

Commodity Code	C22-03
Specs	B4 B9 B10 B11 B14 B30 C8 C10 C11 C30 E8
1. Fitting type	Cap
2. Material	ASTM A234 Gr WPB
3. Standard	ASME B16.9
4. Pressure class or thickness	-
5. End connections	Beveled End
6. Size Range (NPS)	1" - 44"
7. Additional requirement	-
8. Weight	-
9. Dimension	-

Commodity Code	C22-05
Specs	B6 C6 E6 E19 F6
1. Fitting type	Cap
2. Material	ASTM A420 Gr WPL6
3. Standard	ASME B16.9
4. Pressure class or thickness	-
5. End connections	Beveled End
6. Size Range (NPS)	1" - 40"
7. Additional requirement	-
8. Weight	-
9. Dimension	-

Commodity Code	C22-22
Specs	E30 E34 G10 H30
1. Fitting type	Cap
2. Material	ASTM A860 WPHY65
3. Standard	MSS SP-75
4. Pressure class or thickness	""
5. End connections	Beveled End
6. Size Range (NPS)	1" - 34"
7. Additional requirement	-
8. Weight	-
9. Dimension	-

Commodity Code	C22-29
Specs	B16 C16 E16 G16 H16
1. Fitting type	Cap
2. Material	ASTM A815 (UNS S31803)
3. Standard	ASME B16.9
4. Pressure class or thickness	-
5. End connections	Beveled End
6. Size Range (NPS)	1" - 40"
7. Additional requirement	-
8. Weight	-
9. Dimension	-

Commodity Code	C22-32
Specs	B12 H12P H12
1. Fitting type	Cap
2. Material	ASTM A815 (UNS S32760)
3. Standard	ASME B16.9
4. Pressure class or thickness	-
5. End connections	Beveled End
6. Size Range (NPS)	1" - 36"
7. Additional requirement	-
8. Weight	-
9. Dimension	-

Commodity Code	C22-33
Specs	B30 C30 E30 H30
1. Fitting type	Cap
2. Material	ASTM B366 (UNS N06625)
3. Standard	ASME B16.9
4. Pressure class or thickness	-
5. End connections	Beveled End
6. Size Range (NPS)	1" - 14"
7. Additional requirement	-
8. Weight	-
9. Dimension	-

Commodity Code	C22-35
Specs	B7
1. Fitting type	Cap
2. Material	Cu-Ni 90/10 (UNS C7060X)
3. Standard	EEMUA 234
4. Pressure class or thickness	-
5. End connections	Beveled End
6. Size Range (NPS)	2" - 36"
7. Additional requirement	-
8. Weight	-
9. Dimension	-

Commodity Code	C22-44
Specs	B3 C3 E3 G3 H3
1. Fitting type	Cap
2. Material	ASTM A403 Gr WP316/316L
3. Standard	ASME B16.9
4. Pressure class or thickness	-
5. End connections	Beveled End
6. Size Range (NPS)	1" - 44"
7. Additional requirement	-
8. Weight	-
9. Dimension	-

Commodity Code	C22-50
Specs	
1. Fitting type	Cap
2. Material	PVC - ASTM D1784 class 12454
3. Standard	ASTM D2464
4. Pressure class or thickness	-
5. End connections	-
6. Size Range (NPS)	-
7. Additional requirement	-
8. Weight	-
9. Dimension	-

Commodity Code	C22-51
Specs	
1. Fitting type	Cap
2. Material	CPVC - ASTM D1784 class 23447
3. Standard	ASTM F439
4. Pressure class or thickness	-
5. End connections	-
6. Size Range (NPS)	-
7. Additional requirement	-
8. Weight	-
9. Dimension	-

B12.2.23 HEX HEAD BUSHING, B16.11

Commodity Code	C23-35
Specs	B7
1. Fitting type	Hex Head Bushing, B16.11
2. Material	Cu-Ni 90/10 (UNS C7060X)
3. Standard	EEMUA 234
4. Pressure class or thickness	20 bar, 3000, 6000, 9000 1 1/2" 10 bar, 16 bar, 25 bar
5. End connections	Female Capilar, Female NPT Thread x Male Capilar, Male x Female Capilar, NPT Threaded End, Socket weld 1 1/2" Butt-Strap, Elastic Joint / Bell x Spigot Ends, Rigid Joint / Bell x Spigot Ends, Rigid Joint / Spigot Ends
6. Size Range (NPS)	3/8" - 1 1/2"
7. Additional requirement	-

B12.2.24 CROSS

Commodity Code	C24-03
Specs	B4 B9 B10 B11 B14 B30 C8 C10 C11 C30 E8
1. Fitting type	Cross
2. Material	ASTM A234 Gr WPB
3. Standard	ASME B16.9
4. Pressure class or thickness	-
5. End connections	Beveled End
6. Size Range (NPS)	1" - 44"
7. Additional requirement	-
8. Weight	-
9. Dimension	-

Commodity Code	C24-05
Specs	B6 C6 E6 E19 F6
1. Fitting type	Cross
2. Material	ASTM A420 Gr WPL6
3. Standard	ASME B16.9
4. Pressure class or thickness	-
5. End connections	Beveled End
6. Size Range (NPS)	1" - 40"
7. Additional requirement	-
8. Weight	-
9. Dimension	-

Commodity Code	C24-22
Specs	E30 E34 G10 H30
1. Fitting type	Cross
2. Material	ASTM A860 WPHY65
3. Standard	MSS SP-75
4. Pressure class or thickness	""
5. End connections	Beveled End
6. Size Range (NPS)	1" - 24"
7. Additional requirement	-
8. Weight	-
9. Dimension	-

Commodity Code	C24-29
Specs	B16 C16 E16 G16 H16
1. Fitting type	Cross
2. Material	ASTM A815 (UNS S31803)
3. Standard	ASME B16.9
4. Pressure class or thickness	-
5. End connections	Beveled End
6. Size Range (NPS)	1" - 40"
7. Additional requirement	-
8. Weight	-
9. Dimension	-

Commodity Code	C24-32
Specs	B12 H12P H12
1. Fitting type	Cross
2. Material	ASTM A815 (UNS S32760)
3. Standard	ASME B16.9
4. Pressure class or thickness	-
5. End connections	Beveled End
6. Size Range (NPS)	1" - 36"
7. Additional requirement	-
8. Weight	-
9. Dimension	-

Commodity Code	C24-33
Specs	B30 C30 E30 H30
1. Fitting type	Cross
2. Material	ASTM B366 (UNS N06625)
3. Standard	ASME B16.9
4. Pressure class or thickness	-
5. End connections	Beveled End
6. Size Range (NPS)	1" - 14"
7. Additional requirement	-
8. Weight	-
9. Dimension	-

Commodity Code	C24-44
Specs	B3 C3 E3 G3 H3
1. Fitting type	Cross
2. Material	ASTM A403 Gr WP316/316L
3. Standard	ASME B16.9
4. Pressure class or thickness	-
5. End connections	Beveled End
6. Size Range (NPS)	1" - 44"
7. Additional requirement	-
8. Weight	-
9. Dimension	-

Commodity Code	C24-50
Specs	
1. Fitting type	Cross
2. Material	PVC - ASTM D1784 class 12454
3. Standard	ASTM D2464
4. Pressure class or thickness	-
5. End connections	-
6. Size Range (NPS)	-
7. Additional requirement	-
8. Weight	-
9. Dimension	-

Commodity Code	C24-51
Specs	
1. Fitting type	Cross
2. Material	CPVC - ASTM D1784 class 23447
3. Standard	ASTM F439
4. Pressure class or thickness	-
5. End connections	-
6. Size Range (NPS)	-
7. Additional requirement	-
8. Weight	-
9. Dimension	-

B12.2.25 3D 45 DEG PIPE BEND

Commodity Code	C33-28
Specs	G16P
1. Fitting type	3D 45 deg Pipe Bend
2. Material	ASTM A790 (UNS S31803)
3. Standard	NORSOK M-630 NBE2
4. Pressure class or thickness	-
5. End connections	Beveled end
6. Size Range (NPS)	2" - 14"
7. Additional requirement	-
8. Weight	-
9. Dimension	-

Commodity Code	C33-31
Specs	H12P
1. Fitting type	3D 45 deg Pipe Bend
2. Material	ASTM A790 (UNS S32760)
3. Standard	NORSOK M-630 NBE2
4. Pressure class or thickness	-
5. End connections	Beveled end
6. Size Range (NPS)	2" - 18"
7. Additional requirement	-
8. Weight	-
9. Dimension	-

Commodity Code	C33-41
Specs	H12P
1. Fitting type	3D 45 deg Pipe Bend
2. Material	ASTM A928 (UNS S32760 Cl 1 or 3)
3. Standard	NORSOK M-630 NBE2
4. Pressure class or thickness	-
5. End connections	Beveled end
6. Size Range (NPS)	10" - 18"
7. Additional requirement	-
8. Weight	-
9. Dimension	-

Commodity Code	C33-42
Specs	G16P
1. Fitting type	3D 45 deg Pipe Bend
2. Material	ASTM A928 (UNS S31803 Cl 1 or 3)
3. Standard	NORSOK M-630 NBE2
4. Pressure class or thickness	-
5. End connections	Beveled end
6. Size Range (NPS)	10" - 14"
7. Additional requirement	-
8. Weight	-
9. Dimension	-

Commodity Code	C33-46
Specs	
1. Fitting type	3D 45 deg Pipe Bend
2. Material	ASTM A358 TP316/316L
3. Standard	ASME B31.8 (ISO 15590-1 or ASME B16.49)
4. Pressure class or thickness	-
5. End connections	Beveled end
6. Size Range (NPS)	-
7. Additional requirement	-
8. Weight	-
9. Dimension	-

B12.2.26 3D 90 DEG PIPE BEND

Commodity Code	C35-28
Specs	G16P
1. Fitting type	3D 90 deg Pipe Bend
2. Material	ASTM A790 (UNS S31803)
3. Standard	NORSOK M-630 NBE2
4. Pressure class or thickness	-
5. End connections	Beveled end
6. Size Range (NPS)	2" - 14"
7. Additional requirement	-
8. Weight	-
9. Dimension	-

Commodity Code	C35-31
Specs	H12P
1. Fitting type	3D 90 deg Pipe Bend
2. Material	ASTM A790 (UNS S32760)
3. Standard	NORSOK M-630 NBE2
4. Pressure class or thickness	-
5. End connections	Beveled end
6. Size Range (NPS)	2" - 18"
7. Additional requirement	-
8. Weight	-
9. Dimension	-

Commodity Code	C35-41
Specs	H12P
1. Fitting type	3D 90 deg Pipe Bend
2. Material	ASTM A928 (UNS S32760 Cl 1 or 3)
3. Standard	NORSOK M-630 NBE2
4. Pressure class or thickness	-
5. End connections	Beveled end
6. Size Range (NPS)	10" - 18"
7. Additional requirement	-
8. Weight	-
9. Dimension	-

Commodity Code	C35-42
Specs	G16P
1. Fitting type	3D 90 deg Pipe Bend
2. Material	ASTM A928 (UNS S31803 Cl 1 or 3)
3. Standard	NORSOK M-630 NBE2
4. Pressure class or thickness	-
5. End connections	Beveled end
6. Size Range (NPS)	10" - 14"
7. Additional requirement	-
8. Weight	-
9. Dimension	-

Commodity Code	C35-46
Specs	
1. Fitting type	3D 90 deg Pipe Bend
2. Material	ASTM A358 TP316/316L
3. Standard	ASME B31.8 (ISO 15590-1 or ASME B16.49)
4. Pressure class or thickness	-
5. End connections	Beveled end
6. Size Range (NPS)	-
7. Additional requirement	-
8. Weight	-
9. Dimension	-

B12.2.27 CONNECTOR

Commodity Code	C37-35
Specs	B7
1. Fitting type	Connector
2. Material	Cu-Ni 90/10 (UNS C7060X)
3. Standard	EEMUA 234
4. Pressure class or thickness	20 bar
5. End connections	-
6. Size Range (NPS)	½" - 1 ½"
7. Additional requirement	-
8. Weight	-
9. Dimension	-

B12.2.28 CONNECTOR UNION

Commodity Code	C38-35
Specs	B7
1. Fitting type	Connector Union
2. Material	Cu-Ni 90/10 (UNS C7060X)
3. Standard	EEMUA 234
4. Pressure class or thickness	20 bar
5. End connections	-
6. Size Range (NPS)	½" - 1 ½"
7. Additional requirement	-

B12.2.29 STUB END WELDING NECK L TYPE

Commodity Code	C39-35
Specs	B7
1. Fitting type	Stub End Welding Neck L type
2. Material	Cu-Ni 90/10 (UNS C7060X)
3. Standard	EEMUA 234
4. Pressure class or thickness	20 bar 6" - 36" 16 bar
5. End connections	Beveled end
6. Size Range (NPS)	4" - 36"
7. Additional requirement	-
8. Weight	-
9. Dimension	-

B12.2.30 FLANGED SADDLE



Commodity Code	C51-52
Specs	B22
1. Fitting type	Flanged Saddle
2. Material	FRP - Bisphenol A Epoxy resins reinforced with fiberglass type E or E-CR. Design pressure 10bar@90°C
3. Standard	ISO 14692
4. Pressure class or thickness	-
5. End connections	-
6. Size Range (NPS)	1" - 6"
7. Additional requirement	-
8. Weight	-
9. Dimension	-

Commodity Code	C51-53
Specs	B22
1. Fitting type	Flanged Saddle
2. Material	FRP - Bisphenol A Epoxy vinyl ester resins reinforced with fiberglass type E or E-CR. Design pressure 10bar@90°C.
3. Standard	ISO 14692
4. Pressure class or thickness	-
5. End connections	-
6. Size Range (NPS)	-
7. Additional requirement	-
8. Weight	-
9. Dimension	-

Commodity Code	C51-54
Specs	B23
1. Fitting type	Flanged Saddle
2. Material	FRP - Bisphenol A Epoxy resins reinforced with fiberglass type E or E-CR. Design pressure 16bar@90°C
3. Standard	ISO 14692
4. Pressure class or thickness	-
5. End connections	-
6. Size Range (NPS)	1" - 6"
7. Additional requirement	-
8. Weight	-
9. Dimension	-

Commodity Code	C51-55
Specs	B23
1. Fitting type	Flanged Saddle
2. Material	FRP - Bisphenol A Epoxy vinyl ester resins reinforced with fiberglass type E or E-CR. Design pressure 16bar@90°C.
3. Standard	ISO 14692
4. Pressure class or thickness	-
5. End connections	-
6. Size Range (NPS)	-
7. Additional requirement	-
8. Weight	-
9. Dimension	-

Commodity Code	C51-56
Specs	B26
1. Fitting type	Flanged Saddle
2. Material	FRP - Bisphenol A Epoxy resins reinforced with fiberglass type E or E-CR. Design pressure 16bar@120°C
3. Standard	ISO 14692
4. Pressure class or thickness	-
5. End connections	-
6. Size Range (NPS)	1" - 6"
7. Additional requirement	-
8. Weight	-
9. Dimension	-

Commodity Code	C51-57
Specs	B27
1. Fitting type	Flanged Saddle
2. Material	FRP - Epoxy vinyl ester resins (bisphenol A or brominated) reinforced with fiberglass type E-CR, inner liner with fiberglass veils type C. Design pressure 16bar@85°C
3. Standard	ISO 14692
4. Pressure class or thickness	-
5. End connections	-
6. Size Range (NPS)	1" - 4"
7. Additional requirement	-
8. Weight	-
9. Dimension	-

Commodity Code	C51-64
Specs	B28 C23
1. Fitting type	Flanged Saddle
2. Material	FRP - Bisphenol A Epoxy resins reinforced with fiberglass type E or E-CR. Design pressure 25bar@90°C
3. Standard	ISO 14692
4. Pressure class or thickness	-
5. End connections	-
6. Size Range (NPS)	1" - 6"
7. Additional requirement	-
8. Weight	-
9. Dimension	-

B12.2.31 THREADED SADDLE FLG

Commodity Code	C52-52
Specs	B22
1. Fitting type	Threaded Saddle Flg
2. Material	FRP - Bisphenol A Epoxy resins reinforced with fiberglass type E or E-CR. Design pressure 10bar@90°C
3. Standard	ISO 14692
4. Pressure class or thickness	-
5. End connections	-
6. Size Range (NPS)	1" - 1 1/2"
7. Additional requirement	-

Commodity Code	C52-53
Specs	B22
1. Fitting type	Threaded Saddle Flg
2. Material	FRP - Bisphenol A Epoxy vinyl ester resins reinforced with fiberglass type E or E-CR. Design pressure 10bar@90°C.
3. Standard	ISO 14692
4. Pressure class or thickness	-
5. End connections	-
6. Size Range (NPS)	-
7. Additional requirement	-

Commodity Code	C52-54
Specs	B23
1. Fitting type	Threaded Saddle Flg
2. Material	FRP - Bisphenol A Epoxy resins reinforced with fiberglass type E or E-CR. Design pressure 16bar@90°C
3. Standard	ISO 14692
4. Pressure class or thickness	-
5. End connections	-
6. Size Range (NPS)	1" - 6"
7. Additional requirement	-

Commodity Code	C52-55
Specs	B23
1. Fitting type	Threaded Saddle Flg
2. Material	FRP - Bisphenol A Epoxy vinyl ester resins reinforced with fiberglass type E or E-CR. Design pressure 16bar@90°C.
3. Standard	ISO 14692
4. Pressure class or thickness	-
5. End connections	-
6. Size Range (NPS)	-
7. Additional requirement	-

Commodity Code	C52-56
Specs	B26
1. Fitting type	Threaded Saddle Flg
2. Material	FRP - Bisphenol A Epoxy resins reinforced with fiberglass type E or E-CR. Design pressure 16bar@120°C
3. Standard	ISO 14692
4. Pressure class or thickness	-
5. End connections	-
6. Size Range (NPS)	1" - 1 1/2"
7. Additional requirement	-

Commodity Code	C52-57
Specs	B27
1. Fitting type	Threaded Saddle Flg
2. Material	FRP - Epoxy vinyl ester resins (bisphenol A or brominated) reinforced with fiberglass type E-CR, inner liner with fiberglass veils type C. Design pressure 16bar@85°C
3. Standard	ISO 14692
4. Pressure class or thickness	-
5. End connections	-
6. Size Range (NPS)	1" - 1 1/2"
7. Additional requirement	-

Commodity Code	C52-64
Specs	B28 C23
1. Fitting type	Threaded Saddle Flg
2. Material	FRP - Bisphenol A Epoxy resins reinforced with fiberglass type E or E-CR. Design pressure 25bar@90°C
3. Standard	ISO 14692
4. Pressure class or thickness	-
5. End connections	-
6. Size Range (NPS)	1" - 1 1/2"
7. Additional requirement	-

B12.2.32 SOCKOLET

Commodity Code	C55-02
Specs	B4 B9 B10 C8 C10 E8 E34 G10
1. Fitting type	Socketlet
2. Material	ASTM A105
3. Standard	MSS SP-97
4. Pressure class or thickness	3000, 6000
5. End connections	Socket weld
6. Size Range (NPS)	1/2" - 1 1/2"
7. Additional requirement	-
8. Weight	-
9. Dimension	-

Commodity Code	C55-04
Specs	B6 C6 E6 E19 F6
1. Fitting type	Socketlet
2. Material	ASTM A350 Gr LF2 Cl 1
3. Standard	MSS SP-97
4. Pressure class or thickness	3000, 6000
5. End connections	Socket weld
6. Size Range (NPS)	1/2" - 1 1/2"
7. Additional requirement	-
8. Weight	-
9. Dimension	-

Commodity Code	C55-14
Specs	B30 C30 E30
1. Fitting type	Socketlet
2. Material	ASTM A182 Gr F316L
3. Standard	MSS SP-97
4. Pressure class or thickness	3000, 6000
5. End connections	Socket weld
6. Size Range (NPS)	1/2" - 1 1/2"
7. Additional requirement	-
8. Weight	-
9. Dimension	-

Commodity Code	C55-26
Specs	B7
1. Fitting type	Socketlet
2. Material	ASTM A182 Gr F316
3. Standard	MSS SP-97
4. Pressure class or thickness	3000, 6000
5. End connections	Socket weld
6. Size Range (NPS)	1/2" - 1 1/2"
7. Additional requirement	-
8. Weight	-
9. Dimension	-

Commodity Code	C55-27
Specs	B16 C16 E16 G16P G16
1. Fitting type	Socketlet
2. Material	ASTM A182 Gr F51 (UNS S31803)
3. Standard	MSS SP-97
4. Pressure class or thickness	3000, 6000
5. End connections	Socket weld
6. Size Range (NPS)	1/2" - 1 1/2"
7. Additional requirement	-
8. Weight	-
9. Dimension	-

Commodity Code	C55-30
Specs	B12
1. Fitting type	Socketlet
2. Material	ASTM A182 Gr F55 (UNS S32760)
3. Standard	MSS SP-97
4. Pressure class or thickness	3000, 6000
5. End connections	Socket weld
6. Size Range (NPS)	1/2" - 1 1/2"
7. Additional requirement	-
8. Weight	-
9. Dimension	-

Commodity Code	C55-33
Specs	B30 C30 E30
1. Fitting type	Socketlet
2. Material	ASTM B366 (UNS N06625)
3. Standard	MSS SP-97
4. Pressure class or thickness	3000, 6000
5. End connections	Socket weld
6. Size Range (NPS)	1/2" - 1 1/2"
7. Additional requirement	-
8. Weight	-
9. Dimension	-

Commodity Code	C55-35
Specs	B7
1. Fitting type	Socketlet
2. Material	CU-Ni 90/10 (UNS C7060X)
3. Standard	EEMUA 234
4. Pressure class or thickness	-
5. End connections	Capillary
6. Size Range (NPS)	1/2" - 2"
7. Additional requirement	-
8. Weight	-
9. Dimension	-

Commodity Code	C55-43
Specs	B3 C3 E3 G3
1. Fitting type	Socketlet
2. Material	ASTM A182 Gr F316/316L
3. Standard	MSS SP-97
4. Pressure class or thickness	3000
5. End connections	Socket weld
6. Size Range (NPS)	1/2" - 1 1/2"
7. Additional requirement	-
8. Weight	-
9. Dimension	-

B12.2.33 SWEEPolet

Commodity Code	C57-43
Specs	B3 C3
1. Fitting type	Sweepolet
2. Material	ASTM A182 Gr F316/316L
3. Standard	MSS SP-97
4. Pressure class or thickness	-
5. End connections	Beveled end
6. Size Range (NPS)	-
7. Additional requirement	-
8. Weight	-
9. Dimension	-

B12.2.34 COMPRESSION FITTING & ADAPTER

Commodity Code	C60-40
Specs	T60A
1. Fitting type	Compression Fitting & adapter
2. Material	Compression fitting with double ferrule, body AISI 316, ferrules and nuts in AISI 316.
3. Standard	according to manufacturer
4. Pressure class or thickness	6000
5. End connections	Outside Diameter x NPT Thread, Outside Diameter x Outside Diameter, Outside Diameter x Socket Weld
6. Size Range (NPS)	½" - 1 ½"
7. Additional requirement	-
8. Weight	-
9. Dimension	-

B12.2.35 CONCENTRIC REDUCING, FRP

Commodity Code	C61-52
Specs	B22
1. Fitting type	Concentric Reducing, FRP
2. Material	FRP - Bisphenol A Epoxy resins reinforced with fiberglass type E or E-CR. Design pressure 10bar@90°C
3. Standard	ISO 14692
4. Pressure class or thickness	10 bar
5. End connections	Bell-Spigot, Butt-Strap
6. Size Range (NPS)	2" - 48"
7. Additional requirement	-
8. Weight	-
9. Dimension	-

Commodity Code	C61-53
Specs	B22
1. Fitting type	Concentric Reducing, FRP
2. Material	FRP - Bisphenol A Epoxy vinyl ester resins reinforced with fiberglass type E or E-CR. Design pressure 10bar@90°C.
3. Standard	ISO 14692
4. Pressure class or thickness	-
5. End connections	-
6. Size Range (NPS)	-
7. Additional requirement	-
8. Weight	-
9. Dimension	-

Commodity Code	C61-54
Specs	B23
1. Fitting type	Concentric Reducing, FRP
2. Material	FRP - Bisphenol A Epoxy resins reinforced with fiberglass type E or E-CR. Design pressure 16bar@90°C
3. Standard	ISO 14692
4. Pressure class or thickness	16 bar
5. End connections	Butt-Strap 2" - 48"   Bell-Spigot
6. Size Range (NPS)	1 ½" - 64"
7. Additional requirement	-
8. Weight	-
9. Dimension	-

Commodity Code	C61-55
Specs	B22
1. Fitting type	Concentric Reducing, FRP
2. Material	FRP - Bisphenol A Epoxy vinyl ester resins reinforced with fiberglass type E or E-CR. Design pressure 16bar@90°C.
3. Standard	ISO 14692
4. Pressure class or thickness	-
5. End connections	-
6. Size Range (NPS)	-
7. Additional requirement	-
8. Weight	-
9. Dimension	-

Commodity Code	C61-56
Specs	B26
1. Fitting type	Concentric Reducing, FRP
2. Material	FRP - Bisphenol A Epoxy resins reinforced with fiberglass type E or E-CR. Design pressure 16bar@120°C
3. Standard	ISO 14692
4. Pressure class or thickness	16 bar
5. End connections	Butt-Strap
6. Size Range (NPS)	2" - 36"
7. Additional requirement	-
8. Weight	-
9. Dimension	-

Commodity Code	C61-57
Specs	B27
1. Fitting type	Concentric Reducing, FRP
2. Material	FRP - Epoxy vinyl ester resins (bisphenol A or brominated) reinforced with fiberglass type E-CR, inner liner with fiberglass veils type C. Design pressure 16bar@85°C
3. Standard	ISO 14692
4. Pressure class or thickness	16 bar
5. End connections	Butt-Strap
6. Size Range (NPS)	2" - 6"
7. Additional requirement	-
8. Weight	-
9. Dimension	-

Commodity Code	C61-64
Specs	B28 C23
1. Fitting type	Concentric Reducing, FRP
2. Material	FRP - Bisphenol A Epoxy resins reinforced with fiberglass type E or E-CR. Design pressure 25bar@90°C
3. Standard	ISO 14692
4. Pressure class or thickness	25 bar
5. End connections	Butt-Strap
6. Size Range (NPS)	2" - 28"
7. Additional requirement	-
8. Weight	-
9. Dimension	-

B12.2.36 ECCENTRIC REDUCING, FRP

Commodity Code	C62-52
Specs	B22
1. Fitting type	Eccentric Reducing, FRP
2. Material	FRP - Bisphenol A Epoxy resins reinforced with fiberglass type E or E-CR. Design pressure 10bar@90°C
3. Standard	ISO 14692
4. Pressure class or thickness	10 bar
5. End connections	Bell-Spigot, Butt-Strap
6. Size Range (NPS)	2" - 40"
7. Additional requirement	-

Commodity Code	C62-53
Specs	B22
1. Fitting type	Eccentric Reducing, FRP
2. Material	FRP - Bisphenol A Epoxy vinyl ester resins reinforced with fiberglass type E or E-CR. Design pressure 10bar@90°C.
3. Standard	ISO 14692
4. Pressure class or thickness	-
5. End connections	-
6. Size Range (NPS)	-
7. Additional requirement	-

Commodity Code	C62-54
Specs	B23
1. Fitting type	Eccentric Reducing, FRP
2. Material	FRP - Bisphenol A Epoxy vinyl ester resins reinforced with fiberglass type E or E-CR. Design pressure 16bar@90°C
3. Standard	ISO 14692
4. Pressure class or thickness	16 bar
5. End connections	Butt-Strap 2" - 48"   Bell-Spigot
6. Size Range (NPS)	2" - 64"
7. Additional requirement	-

Commodity Code	C62-55
Specs	B22
1. Fitting type	Eccentric Reducing, FRP
2. Material	FRP - Bisphenol A Epoxy vinyl ester resins reinforced with fiberglass type E or E-CR. Design pressure 16bar@90°C.
3. Standard	ISO 14692
4. Pressure class or thickness	-
5. End connections	-
6. Size Range (NPS)	-
7. Additional requirement	-

Commodity Code	C62-56
Specs	B26
1. Fitting type	Eccentric Reducing, FRP
2. Material	FRP - Bisphenol A Epoxy resins reinforced with fiberglass type E or E-CR. Design pressure 16bar@120°C
3. Standard	ISO 14692
4. Pressure class or thickness	16 bar
5. End connections	Butt-Strap
6. Size Range (NPS)	2" - 36"
7. Additional requirement	-

Commodity Code	C62-57
Specs	B27
1. Fitting type	Eccentric Reducing, FRP
2. Material	FRP - Epoxy vinyl ester resins (bisphenol A or brominated) reinforced with fiberglass type E-CR, inner liner with fiberglass veils type C. Design pressure 16bar@85°C
3. Standard	ISO 14692
4. Pressure class or thickness	16 bar
5. End connections	Butt-Strap
6. Size Range (NPS)	2" - 6"
7. Additional requirement	-

Commodity Code	C62-64
Specs	B28 C23
1. Fitting type	Eccentric Reducing, FRP
2. Material	FRP - Bisphenol A Epoxy resins reinforced with fiberglass type E or E-CR. Design pressure 25bar@90°C
3. Standard	ISO 14692
4. Pressure class or thickness	25 bar
5. End connections	Butt-Strap
6. Size Range (NPS)	2" - 28"
7. Additional requirement	-

B12.2.37 FRP REDUCING TEE

Commodity Code	C63-52
Specs	B22
1. Fitting type	FRP Reducing Tee
2. Material	FRP - Bisphenol A Epoxy resins reinforced with fiberglass type E or E-CR. Design pressure 10bar@90°C
3. Standard	ISO 14692
4. Pressure class or thickness	10 bar
5. End connections	Bell-Spigot, Butt-Strap
6. Size Range (NPS)	2" - 40"
7. Additional requirement	-
8. Weight	-
9. Dimension	-

Commodity Code	C63-53
Specs	B22
1. Fitting type	FRP Reducing Tee
2. Material	FRP - Bisphenol A Epoxy vinyl ester resins reinforced with fiberglass type E or E-CR. Design pressure 10bar@90°C.
3. Standard	ISO 14692
4. Pressure class or thickness	-
5. End connections	-
6. Size Range (NPS)	-
7. Additional requirement	-
8. Weight	-
9. Dimension	-

Commodity Code	C63-54
Specs	B23
1. Fitting type	FRP Reducing Tee
2. Material	FRP - Bisphenol A Epoxy resins reinforced with fiberglass type E or E-CR. Design pressure 16bar@90°C
3. Standard	ISO 14692
4. Pressure class or thickness	16 bar
5. End connections	Bell-Spigot, Butt-Strap
6. Size Range (NPS)	2" - 48"
7. Additional requirement	-
8. Weight	-
9. Dimension	-

Commodity Code	C63-55
Specs	B22
1. Fitting type	FRP Reducing Tee
2. Material	FRP - Bisphenol A Epoxy vinyl ester resins reinforced with fiberglass type E or E-CR. Design pressure 16bar@90°C.
3. Standard	ISO 14692
4. Pressure class or thickness	-
5. End connections	-
6. Size Range (NPS)	-
7. Additional requirement	-
8. Weight	-
9. Dimension	-

Commodity Code	C63-56
Specs	B26
1. Fitting type	FRP Reducing Tee
2. Material	FRP - Bisphenol A Epoxy resins reinforced with fiberglass type E or E-CR. Design pressure 16bar@120°C
3. Standard	ISO 14692
4. Pressure class or thickness	16 bar
5. End connections	Butt-Strap
6. Size Range (NPS)	2" - 36"
7. Additional requirement	-
8. Weight	-
9. Dimension	-

Commodity Code	C63-57
Specs	B27
1. Fitting type	FRP Reducing Tee
2. Material	FRP - Epoxy vinyl ester resins (bisphenol A or brominated) reinforced with fiberglass type E-CR, inner liner with fiberglass veils type C. Design pressure 16bar@85°C
3. Standard	ISO 14692
4. Pressure class or thickness	16 bar
5. End connections	Butt-Strap
6. Size Range (NPS)	2" - 3"
7. Additional requirement	-
8. Weight	-
9. Dimension	-

Commodity Code	C63-64
Specs	B28 C23
1. Fitting type	FRP Reducing Tee
2. Material	FRP - Bisphenol A Epoxy resins reinforced with fiberglass type E or E-CR. Design pressure 25bar@90°C
3. Standard	ISO 14692
4. Pressure class or thickness	25 bar
5. End connections	Butt-Strap
6. Size Range (NPS)	2" - 28"
7. Additional requirement	-
8. Weight	-
9. Dimension	-

B12.2.38 FRP STUB END



Commodity Code	C64-54
Specs	B23 B28
Commodity Code	C64-64
Specs	C23

Commodity Code	C64-55
Specs	

Commodity Code	C64-56
Specs	B26

Commodity Code	C64-57
Specs	



Commodity Code	N-E405
Specs	B6 C6 E6 E19 F6
1. Nipple type	Swage Eccentric Nipple
2. Material	ASTM A420 Gr WPL6
3. Standard	MSS SP-95
4. Schedule (SCH) or thickness	-
5. End connections	Bevel Large End x Plain Small End
6. Size Range (NPS)	2" - 4"
7. Additional requirement	-
8. Weight	-
9. Dimension	-

Commodity Code	N-E422
Specs	E34 G10
1. Nipple type	Swage Eccentric Nipple
2. Material	ASTM A860 WPHY65
3. Standard	MSS SP-95
4. Schedule (SCH) or thickness	-
5. End connections	Bevel Large End x Plain Small End
6. Size Range (NPS)	2" - 4"
7. Additional requirement	-
8. Weight	-
9. Dimension	-

Commodity Code	N-E429
Specs	B16 C16 E16 G16
1. Nipple type	Swage Eccentric Nipple
2. Material	ASTM A815 (UNS S31803)
3. Standard	MSS SP-95
4. Schedule (SCH) or thickness	-
5. End connections	Bevel Large End x Plain Small End
6. Size Range (NPS)	2" - 4"
7. Additional requirement	-
8. Weight	-
9. Dimension	-

Commodity Code	N-E432
Specs	B12
1. Nipple type	Swage Eccentric Nipple
2. Material	ASTM A815 (UNS S32760)
3. Standard	MSS SP-95
4. Schedule (SCH) or thickness	-
5. End connections	Bevel Large End x Plain Small End
6. Size Range (NPS)	2" - 4"
7. Additional requirement	-
8. Weight	-
9. Dimension	-

Commodity Code	N-E433
Specs	B30 C30 E30
1. Nipple type	Swage Eccentric Nipple
2. Material	ASTM B366 (UNS N06625)
3. Standard	MSS SP-95
4. Schedule (SCH) or thickness	-
5. End connections	Bevel Large End x Plain Small End
6. Size Range (NPS)	3/4" - 4"
7. Additional requirement	-
8. Weight	-
9. Dimension	-

Commodity Code	N-E444
Specs	B3 C3 E3 G3
1. Nipple type	Swage Eccentric Nipple
2. Material	ASTM A403 Gr WP316/316L
3. Standard	MSS SP-95
4. Schedule (SCH) or thickness	-
5. End connections	Bevel Large End x Plain Small End
6. Size Range (NPS)	2" - 4"
7. Additional requirement	-
8. Weight	-
9. Dimension	-

B12.3.4 STRAIGHT NIPPLE

Commodity Code	N-S120
Specs	B4 B9 B10 C8 C10 E8 E34 G10
1. Nipple type	Straight Nipple
2. Material	API 5L Gr B PSL 1 seamless
3. Standard	ASTM A733
4. Schedule (SCH) or thickness	-
5. End connections	Plain Both Ends
6. Size Range (NPS)	1/2" - 1 1/2"
7. Additional requirement	-
8. Weight	-
9. Dimension	-

Commodity Code	N-S123
Specs	
1. Nipple type	Straight Nipple
2. Material	ASTM A333 Gr 8
3. Standard	ASTM A733
4. Schedule (SCH) or thickness	-
5. End connections	Plain Both Ends
6. Size Range (NPS)	-
7. Additional requirement	-
8. Weight	-
9. Dimension	-

Commodity Code	N-S128
Specs	B16 C16 E16 G16P G16
1. Nipple type	Straight Nipple
2. Material	ASTM A790 (UNS S31803)
3. Standard	ASTM A733
4. Schedule (SCH) or thickness	-
5. End connections	Plain Both Ends
6. Size Range (NPS)	1/2" - 1 1/2"
7. Additional requirement	-
8. Weight	-
9. Dimension	-

Commodity Code	N-S131
Specs	B12
1. Nipple type	Straight Nipple
2. Material	ASTM A790 (UNS S32760)
3. Standard	ASTM A733
4. Schedule (SCH) or thickness	-
5. End connections	Plain Both Ends
6. Size Range (NPS)	1/2" - 1 1/2"
7. Additional requirement	-
8. Weight	-
9. Dimension	-

Commodity Code	N-S137
Specs	B6 C6 E6 E19 F6
1. Nipple type	Straight Nipple
2. Material	ASTM A333 Gr 6
3. Standard	ASTM A733
4. Schedule (SCH) or thickness	-
5. End connections	Plain Both Ends
6. Size Range (NPS)	1/2" - 1 1/2"
7. Additional requirement	-
8. Weight	-
9. Dimension	-

Commodity Code	N-S139
Specs	B30 C30 E30
1. Nipple type	Straight Nipple
2. Material	ASTM B444 Gr 1 (UNS N06625)
3. Standard	ASTM A733
4. Schedule (SCH) or thickness	-
5. End connections	Plain Both Ends
6. Size Range (NPS)	1/2" - 1 1/2"
7. Additional requirement	-
8. Weight	-
9. Dimension	-

Commodity Code	N-S140
Specs	
1. Nipple type	Straight Nipple
2. Material	Straight Nipple, NPT nut, ASTM A312 Grade TP 316, SC, ASTM A733
3. Standard	-
4. Schedule (SCH) or thickness	-
5. End connections	Plain Both Ends
6. Size Range (NPS)	-
7. Additional requirement	-
8. Weight	-
9. Dimension	-

Commodity Code	N-S145
Specs	B3 C3 E3 G3
1. Nipple type	Straight Nipple
2. Material	ASTM A312 TP316/316L
3. Standard	ASTM A733
4. Schedule (SCH) or thickness	-
5. End connections	Plain Both Ends
6. Size Range (NPS)	1/2" - 1 1/2"
7. Additional requirement	-
8. Weight	-
9. Dimension	-

Commodity Code	N-S228
Specs	H16
1. Nipple type	Straight Nipple
2. Material	ASTM A790 (UNS S31803)
3. Standard	ASTM A733
4. Schedule (SCH) or thickness	-
5. End connections	Bevel Both Ends
6. Size Range (NPS)	1" - 1 1/2"
7. Additional requirement	-
8. Weight	-
9. Dimension	-

Commodity Code	N-S231
Specs	H12P H12
1. Nipple type	Straight Nipple
2. Material	ASTM A790 (UNS S32760)
3. Standard	ASTM A733
4. Schedule (SCH) or thickness	-
5. End connections	Bevel Both Ends
6. Size Range (NPS)	1" - 1 1/2"
7. Additional requirement	-
8. Weight	-
9. Dimension	-

Commodity Code	N-S239
Specs	H30
1. Nipple type	Straight Nipple
2. Material	ASTM B444 Gr 1 (UNS N06625)
3. Standard	ASTM A733
4. Schedule (SCH) or thickness	-
5. End connections	Bevel Both Ends
6. Size Range (NPS)	1" - 1 1/2"
7. Additional requirement	-
8. Weight	-
9. Dimension	-

Commodity Code	N-S245
Specs	H3
1. Nipple type	Straight Nipple
2. Material	ASTM A312 TP316/316L
3. Standard	ASTM A733
4. Schedule (SCH) or thickness	-
5. End connections	Bevel Both Ends
6. Size Range (NPS)	-
7. Additional requirement	-
8. Weight	-
9. Dimension	-





Commodity Code	F-600-R3
Specs	
1. Flange type	Welding Neck Flange (WN)
2. Material	ASTM A350 Gr LF2 Class 1
3. Standard	-
4. Pressure class	Class 600
5. Flange facing	Ring Type Joint
6. Face finishing	Surface finish not exceed 63 µin.
7. Coating	-
8. Schedule (SCH) or thickness	-
9. Size Range (NPS)	-
10. Additional requirement	-
11. Weight	-
12. Dimension	-

Commodity Code	F-600-R7
Specs	
1. Flange type	Welding Neck Flange (WN)
2. Material	ASTM A182 Gr F316L
3. Standard	-
4. Pressure class	Class 600
5. Flange facing	Ring Type Joint
6. Face finishing	Surface finish not exceed 63 µin.
7. Coating	-
8. Schedule (SCH) or thickness	-
9. Size Range (NPS)	-
10. Additional requirement	-
11. Weight	-
12. Dimension	-

Commodity Code	F-600-RB
Specs	
1. Flange type	Welding Neck Flange (WN)
2. Material	ASTM A105 Cladded
3. Standard	-
4. Pressure class	Class 600
5. Flange facing	Ring Type Joint
6. Face finishing	Surface finish not exceed 63 µin.
7. Coating	Inconel (UNS N06625) clad
8. Schedule (SCH) or thickness	-
9. Size Range (NPS)	-
10. Additional requirement	-
11. Weight	-
12. Dimension	-

Commodity Code	F-600-RC
Specs	
1. Flange type	Welding Neck Flange (WN)
2. Material	ASTM A694 Gr F65
3. Standard	-
4. Pressure class	Class 600
5. Flange facing	Ring Type Joint
6. Face finishing	Surface finish not exceed 63 µin.
7. Coating	-
8. Schedule (SCH) or thickness	-
9. Size Range (NPS)	-
10. Additional requirement	-
11. Weight	-
12. Dimension	-

Commodity Code	F-600-RE
Specs	
1. Flange type	Welding Neck Flange (WN)
2. Material	ASTM A350 Gr LF3 Cladded
3. Standard	-
4. Pressure class	Class 600
5. Flange facing	Ring Type Joint
6. Face finishing	Surface finish not exceed 63 µin.
7. Coating	Inconel (UNS N06625) clad
8. Schedule (SCH) or thickness	-
9. Size Range (NPS)	-
10. Additional requirement	-
11. Weight	-
12. Dimension	-

Commodity Code	F-600-RG
Specs	
1. Flange type	Welding Neck Flange (WN)
2. Material	ASTM A182 Gr F51
3. Standard	-
4. Pressure class	Class 600
5. Flange facing	Ring Type Joint
6. Face finishing	Surface finish not exceed 63 µin.
7. Coating	-
8. Schedule (SCH) or thickness	-
9. Size Range (NPS)	-
10. Additional requirement	-
11. Weight	-
12. Dimension	-

Commodity Code	F-600-RL
Specs	
1. Flange type	Welding Neck Flange (WN)
2. Material	ASTM B564 (UNS N06625)
3. Standard	-
4. Pressure class	Class 600
5. Flange facing	Ring Type Joint
6. Face finishing	Surface finish not exceed 63 µin.
7. Coating	-
8. Schedule (SCH) or thickness	-
9. Size Range (NPS)	-
10. Additional requirement	-
11. Weight	-
12. Dimension	-

Commodity Code	F-900-R3
Specs	
1. Flange type	Welding Neck Flange (WN)
2. Material	ASTM A350 Gr LF2 Class 1
3. Standard	-
4. Pressure class	Class 900
5. Flange facing	Ring Type Joint
6. Face finishing	Surface finish not exceed 63 µin.
7. Coating	-
8. Schedule (SCH) or thickness	-
9. Size Range (NPS)	3" - 20"
10. Additional requirement	-
11. Weight	-
12. Dimension	-

Commodity Code	F-900-RB
Specs	
1. Flange type	Welding Neck Flange (WN)
2. Material	ASTM A105 Cladded
3. Standard	-
4. Pressure class	Class 900
5. Flange facing	Ring Type Joint
6. Face finishing	Surface finish not exceed 63 µin.
7. Coating	Inconel (UNS N06625) clad
8. Schedule (SCH) or thickness	-
9. Size Range (NPS)	4" - 24"
10. Additional requirement	-
11. Weight	-
12. Dimension	-

B12.4.2 INTEGRAL FRP FLANGE

Commodity Code	F-10-1T
Specs	
1. Flange type	Integral FRP Flange
2. Material	FRP - Bisphenol A Epoxy resins reinforced with fiberglass type E or E-CR. Suitable for 90°C.
3. Standard	ASTM D4024 - Drilling acc. B16.5/B16.47 CL150
4. Pressure class	10 bar
5. Flange facing	Flat Face
6. Face finishing	-
7. Coating	-
8. Schedule (SCH) or thickness	-
9. Size Range (NPS)	1" - 40"
10. Additional requirement	-
11. Weight	-
12. Dimension	-

Commodity Code	F-16-1S
Specs	
1. Flange type	Integral FRP Flange
2. Material	FRP - Epoxy vinyl ester resins (Bisphenol A or brominated) reinforced with fiberglass type E-CR. Suitable for 85°C.
3. Standard	ASTM D4024 - Drilling acc. B16.5/B16.47 CL150
4. Pressure class	16 bar
5. Flange facing	Flat Face
6. Face finishing	-
7. Coating	-
8. Schedule (SCH) or thickness	-
9. Size Range (NPS)	1" - 6"
10. Additional requirement	-
11. Weight	-
12. Dimension	-

Commodity Code	F-16-1U
Specs	
1. Flange type	Integral FRP Flange
2. Material	FRP - Bisphenol A Epoxy resins reinforced with fiberglass type E or E-CR. Suitable for 120°C.
3. Standard	ASTM D4024 - Drilling acc. B16.5/B16.47 CL150
4. Pressure class	16 bar
5. Flange facing	Flat Face
6. Face finishing	-
7. Coating	-
8. Schedule (SCH) or thickness	-
9. Size Range (NPS)	-
10. Additional requirement	-
11. Weight	-
12. Dimension	-

B12.4.3 BLIND FLANGE

Commodity Code	F-10-ET
Specs	
1. Flange type	Blind Flange
2. Material	FRP - Bisphenol A Epoxy resins reinforced with fiberglass type E or E-CR. Suitable for 90°C.
3. Standard	ASTM D4024 - Drilling acc. B16.5/B16.47 CL150
4. Pressure class	10 bar
5. Flange facing	Flat Face
6. Face finishing	-
7. Coating	-
8. Schedule (SCH) or thickness	-
9. Size Range (NPS)	1" - 40"
10. Additional requirement	-
11. Weight	-
12. Dimension	-

Commodity Code	F-1500-S2
Specs	
1. Flange type	Blind Flange
2. Material	ASTM A105
3. Standard	ASME B16.5
4. Pressure class	Class 1500
5. Flange facing	Ring Type Joint
6. Face finishing	Surface finish not exceed 63 µin.
7. Coating	-
8. Schedule (SCH) or thickness	-
9. Size Range (NPS)	½" - 1 ½"
10. Additional requirement	-
11. Weight	-
12. Dimension	-

Commodity Code	F-1500-S3
Specs	
1. Flange type	Blind Flange
2. Material	ASTM A350 Gr LF2 Class 1
3. Standard	-
4. Pressure class	Class 1500
5. Flange facing	Ring Type Joint
6. Face finishing	Surface finish not exceed 63 µin.
7. Coating	-
8. Schedule (SCH) or thickness	-
9. Size Range (NPS)	½" - 18"
10. Additional requirement	-
11. Weight	-
12. Dimension	-

Commodity Code	F-1500-SC
Specs	
1. Flange type	Blind Flange
2. Material	ASTM A694 Gr F65
3. Standard	ASME B16.5
4. Pressure class	Class 1500
5. Flange facing	Ring Type Joint
6. Face finishing	Surface finish not exceed 63 µin.
7. Coating	-
8. Schedule (SCH) or thickness	-
9. Size Range (NPS)	4" - 24"
10. Additional requirement	-
11. Weight	-
12. Dimension	-

Commodity Code	F-1500-SG
Specs	
1. Flange type	Blind Flange
2. Material	ASTM A182 Gr F51
3. Standard	-
4. Pressure class	Class 1500
5. Flange facing	Ring Type Joint
6. Face finishing	Surface finish not exceed 63 µin.
7. Coating	-
8. Schedule (SCH) or thickness	-
9. Size Range (NPS)	½" - 24"
10. Additional requirement	-
11. Weight	-
12. Dimension	-

Commodity Code	F-1500-SX
Specs	
1. Flange type	Blind Flange
2. Material	ASTM A182 Gr F316/316L
3. Standard	-
4. Pressure class	Class 1500
5. Flange facing	Ring Type Joint
6. Face finishing	Surface finish not exceed 63 µin.
7. Coating	-
8. Schedule (SCH) or thickness	-
9. Size Range (NPS)	½" - 20"
10. Additional requirement	-
11. Weight	-
12. Dimension	-

Commodity Code	F-150-E2
Specs	
1. Flange type	Blind Flange
2. Material	ASTM A105
3. Standard	-
4. Pressure class	Class 150
5. Flange facing	Flat Face
6. Face finishing	125-250 µin. surface finish
7. Coating	-
8. Schedule (SCH) or thickness	-
9. Size Range (NPS)	½" - 44"
10. Additional requirement	-
11. Weight	-
12. Dimension	-

Commodity Code	F-150-L2
Specs	
1. Flange type	Blind Flange
2. Material	ASTM A105
3. Standard	-
4. Pressure class	Class 150
5. Flange facing	Raised Face
6. Face finishing	125-250 µin. surface finish
7. Coating	-
8. Schedule (SCH) or thickness	-
9. Size Range (NPS)	½" - 44"
10. Additional requirement	-
11. Weight	-
12. Dimension	-

Commodity Code	F-150-L3
Specs	
1. Flange type	Blind Flange
2. Material	ASTM A350 Gr LF2 Class 1
3. Standard	-
4. Pressure class	Class 150
5. Flange facing	Raised Face
6. Face finishing	125-250 µin. surface finish
7. Coating	-
8. Schedule (SCH) or thickness	-
9. Size Range (NPS)	½" - 40"
10. Additional requirement	-
11. Weight	-
12. Dimension	-

Commodity Code	F-150-LB
Specs	
1. Flange type	Blind Flange
2. Material	ASTM A105 Cladded
3. Standard	4" - 24" ASME B16.5 26" - 30" ASME B16.47 Series A
4. Pressure class	Class 150
5. Flange facing	Raised Face
6. Face finishing	125-250 µin. surface finish
7. Coating	Inconel (UNS N06625) clad
8. Schedule (SCH) or thickness	-
9. Size Range (NPS)	4" - 30"
10. Additional requirement	-
11. Weight	-
12. Dimension	-

Commodity Code	F-150-LG
Specs	
1. Flange type	Blind Flange
2. Material	ASTM A182 Gr F51
3. Standard	-
4. Pressure class	Class 150
5. Flange facing	Raised Face
6. Face finishing	125-250 µin. surface finish
7. Coating	-
8. Schedule (SCH) or thickness	-
9. Size Range (NPS)	½" - 40"
10. Additional requirement	-
11. Weight	-
12. Dimension	-

Commodity Code	F-150-LH
Specs	
1. Flange type	Blind Flange
2. Material	ASTM A182 Gr F55
3. Standard	-
4. Pressure class	Class 150
5. Flange facing	Raised Face
6. Face finishing	125-250 µin. surface finish
7. Coating	-
8. Schedule (SCH) or thickness	-
9. Size Range (NPS)	½" - 36"
10. Additional requirement	-
11. Weight	-
12. Dimension	-

Commodity Code	F-150-LL
Specs	B30
1. Flange type	Blind Flange
2. Material	ASTM B564 (UNS N06625)
3. Standard	-
4. Pressure class	Class 150
5. Flange facing	Raised Face
6. Face finishing	125-250 µin. surface finish
7. Coating	-
8. Schedule (SCH) or thickness	-
9. Size Range (NPS)	-
10. Additional requirement	-
11. Weight	-
12. Dimension	-

Commodity Code	F-150-LX
Specs	B3
1. Flange type	Blind Flange
2. Material	ASTM A182 Gr F316/316L
3. Standard	½" - 24" ASME B16.5 26" - 44" ASME B16.47 Series A
4. Pressure class	Class 150
5. Flange facing	Raised Face
6. Face finishing	125-250 µin. surface finish
7. Coating	-
8. Schedule (SCH) or thickness	-
9. Size Range (NPS)	½" - 44"
10. Additional requirement	-
11. Weight	-
12. Dimension	-

Commodity Code	F-150-LY
Specs	B7
1. Flange type	Blind Flange
2. Material	ASTM A105 Thermal Spray coated (note 126)
3. Standard	½" - 24" ASME B16.5 28" - 36" ASME B16.47 Series A
4. Pressure class	Class 150
5. Flange facing	Raised Face
6. Face finishing	125-250 µin. surface finish
7. Coating	-
8. Schedule (SCH) or thickness	-
9. Size Range (NPS)	½" - 36"
10. Additional requirement	-
11. Weight	-
12. Dimension	-

Commodity Code	F-16-ES
Specs	B27
1. Flange type	Blind Flange
2. Material	FRP - Epoxy vinyl ester resins (bisphenol A or brominated) reinforced with fiberglass type E-CR. Suitable for 85°C.
3. Standard	ASTM D4024 - Drilling acc. B16.5/B16.47 CL150
4. Pressure class	16 bar
5. Flange facing	Flat Face
6. Face finishing	-
7. Coating	-
8. Schedule (SCH) or thickness	-
9. Size Range (NPS)	1" - 6"
10. Additional requirement	-
11. Weight	-
12. Dimension	-

Commodity Code	F-16-EU
Specs	B26
1. Flange type	Blind Flange
2. Material	FRP - Bisphenol A Epoxy resins reinforced with fiberglass type E or E-CR. Suitable for 120°C.
3. Standard	ASTM D4024 - Drilling acc. B16.5/B16.47 CL150
4. Pressure class	16 bar
5. Flange facing	Flat Face
6. Face finishing	-
7. Coating	-
8. Schedule (SCH) or thickness	-
9. Size Range (NPS)	1" - 36"
10. Additional requirement	-
11. Weight	-
12. Dimension	-

Commodity Code	F-16-LT
Specs	B23 B28
1. Flange type	Blind Flange
2. Material	FRP - Bisphenol A Epoxy resins reinforced with fiberglass type E or E-CR. Suitable for 90°C.
3. Standard	ASTM D4024 - Drilling acc. B16.5/B16.47 CL150
4. Pressure class	16 bar
5. Flange facing	Raised Face
6. Face finishing	-
7. Coating	-
8. Schedule (SCH) or thickness	-
9. Size Range (NPS)	1" - 48"
10. Additional requirement	-
11. Weight	-
12. Dimension	-

Commodity Code	F-2500-SJ
Specs	
1. Flange type	Blind Flange
2. Material	ASTM A522 Type 1
3. Standard	-
4. Pressure class	Class 2500
5. Flange facing	Ring Type Joint
6. Face finishing	Surface finish not exceed 63 µin.
7. Coating	-
8. Schedule (SCH) or thickness	-
9. Size Range (NPS)	1" - 12"
10. Additional requirement	-
11. Weight	-
12. Dimension	-

Commodity Code	F-2500-SK
Specs	
1. Flange type	Blind Flange
2. Material	ASTM A522 Type I Cladded
3. Standard	-
4. Pressure class	Class 2500
5. Flange facing	Ring Type Joint
6. Face finishing	Surface finish not exceed 63 µin.
7. Coating	Inconel (UNS N06625) clad
8. Schedule (SCH) or thickness	-
9. Size Range (NPS)	4" - 12"
10. Additional requirement	-
11. Weight	-
12. Dimension	-

Commodity Code	F-25-LT
Specs	C23
1. Flange type	Blind Flange
2. Material	FRP - Bisphenol A Epoxy resins reinforced with fiberglass type E or E-CR. Suitable for 90°C.
3. Standard	ASTM D4024 - Drilling acc. B16.5/B16.47 CL300
4. Pressure class	25 bar
5. Flange facing	Raised Face
6. Face finishing	-
7. Coating	-
8. Schedule (SCH) or thickness	-
9. Size Range (NPS)	1" - 28"
10. Additional requirement	-
11. Weight	-
12. Dimension	-

Commodity Code	F-300-L2
Specs	C8 C10 C11
1. Flange type	Blind Flange
2. Material	ASTM A105
3. Standard	-
4. Pressure class	Class 300
5. Flange facing	Raised Face
6. Face finishing	125-250 µin. surface finish
7. Coating	-
8. Schedule (SCH) or thickness	-
9. Size Range (NPS)	½" - 32"
10. Additional requirement	-
11. Weight	-
12. Dimension	-

Commodity Code	F-300-L3
Specs	C6
1. Flange type	Blind Flange
2. Material	ASTM A350 Gr LF2 Class 1
3. Standard	-
4. Pressure class	Class 300
5. Flange facing	Raised Face
6. Face finishing	125-250 µin. surface finish
7. Coating	-
8. Schedule (SCH) or thickness	-
9. Size Range (NPS)	½" - 30"
10. Additional requirement	-
11. Weight	-
12. Dimension	-

Commodity Code	F-300-LB
Specs	C30
1. Flange type	Blind Flange
2. Material	ASTM A105 Cladded
3. Standard	-
4. Pressure class	Class 300
5. Flange facing	Raised Face
6. Face finishing	125-250 µin. surface finish
7. Coating	Inconel (UNS N06625) clad
8. Schedule (SCH) or thickness	-
9. Size Range (NPS)	4" - 30"
10. Additional requirement	-
11. Weight	-
12. Dimension	-

Commodity Code	F-300-LG
Specs	C16
1. Flange type	Blind Flange
2. Material	ASTM A182 Gr F51
3. Standard	-
4. Pressure class	Class 300
5. Flange facing	Raised Face
6. Face finishing	125-250 µin. surface finish
7. Coating	-
8. Schedule (SCH) or thickness	-
9. Size Range (NPS)	½" - 32"
10. Additional requirement	-
11. Weight	-
12. Dimension	-

Commodity Code	F-300-LL
Specs	C30
1. Flange type	Blind Flange
2. Material	ASTM B564 (UNS N06625)
3. Standard	-
4. Pressure class	Class 300
5. Flange facing	Raised Face
6. Face finishing	125-250 µin. surface finish
7. Coating	-
8. Schedule (SCH) or thickness	-
9. Size Range (NPS)	½" - 3"
10. Additional requirement	-
11. Weight	-
12. Dimension	-

Commodity Code	F-300-LV
Specs	
1. Flange type	Blind Flange
2. Material	ASTM A105 Epoxy coated
3. Standard	-
4. Pressure class	Class 300
5. Flange facing	Raised Face
6. Face finishing	125-250 µin. surface finish
7. Coating	-
8. Schedule (SCH) or thickness	-
9. Size Range (NPS)	-
10. Additional requirement	-
11. Weight	-
12. Dimension	-

Commodity Code	F-300-LX
Specs	C3
1. Flange type	Blind Flange
2. Material	ASTM A182 Gr F316/316L
3. Standard	-
4. Pressure class	Class 300
5. Flange facing	Raised Face
6. Face finishing	125-250 µin. surface finish
7. Coating	-
8. Schedule (SCH) or thickness	-
9. Size Range (NPS)	½" - 38"
10. Additional requirement	-
11. Weight	-
12. Dimension	-

Commodity Code	F-300-SW
Specs	
1. Flange type	Blind Flange
2. Material	ASTM A182 Gr F310H
3. Standard	-
4. Pressure class	Class 300
5. Flange facing	Ring Type Joint
6. Face finishing	Surface finish not exceed 63 µin.
7. Coating	-
8. Schedule (SCH) or thickness	-
9. Size Range (NPS)	½" - 36"
10. Additional requirement	-
11. Weight	-
12. Dimension	-

Commodity Code	F-350-4X
Specs	B3 C3 E3 G3
1. Flange type	Blind Flange
2. Material	ASTM A182 Gr F316/316L
3. Standard	ISO 6162-1
4. Pressure class	max 350 bar
5. Flange facing	-
6. Face finishing	-
7. Coating	-
8. Schedule (SCH) or thickness	-
9. Size Range (NPS)	½" - 3"
10. Additional requirement	-
11. Weight	-
12. Dimension	-

Commodity Code	F-420-4X
Specs	H3
1. Flange type	Blind Flange
2. Material	ASTM A182 Gr F316/316L
3. Standard	ISO 6162-2
4. Pressure class	max 420 bar
5. Flange facing	-
6. Face finishing	-
7. Coating	-
8. Schedule (SCH) or thickness	-
9. Size Range (NPS)	1" - 3"
10. Additional requirement	-
11. Weight	-
12. Dimension	-

Commodity Code	F-600-L2
Specs	E8 E34
1. Flange type	Blind Flange
2. Material	ASTM A105
3. Standard	-
4. Pressure class	Class 600
5. Flange facing	Raised Face
6. Face finishing	125-250 µin. surface finish
7. Coating	-
8. Schedule (SCH) or thickness	-
9. Size Range (NPS)	½" - 8"
10. Additional requirement	-
11. Weight	-
12. Dimension	-

Commodity Code	F-600-L3
Specs	E6 E19
1. Flange type	Blind Flange
2. Material	ASTM A350 Gr LF2 Class 1
3. Standard	-
4. Pressure class	Class 600
5. Flange facing	Raised Face
6. Face finishing	125-250 µin. surface finish
7. Coating	-
8. Schedule (SCH) or thickness	-
9. Size Range (NPS)	½" - 26"
10. Additional requirement	-
11. Weight	-
12. Dimension	-

Commodity Code	F-600-LC
Specs	E30 E34
1. Flange type	Blind Flange
2. Material	ASTM A694 Gr F65
3. Standard	-
4. Pressure class	Class 600
5. Flange facing	Raised Face
6. Face finishing	125-250 µin. surface finish
7. Coating	-
8. Schedule (SCH) or thickness	-
9. Size Range (NPS)	2" - 24"
10. Additional requirement	-
11. Weight	-
12. Dimension	-

Commodity Code	F-600-LG
Specs	E16
1. Flange type	Blind Flange
2. Material	ASTM A182 Gr F51
3. Standard	-
4. Pressure class	Class 600
5. Flange facing	Raised Face
6. Face finishing	125-250 µin. surface finish
7. Coating	-
8. Schedule (SCH) or thickness	-
9. Size Range (NPS)	½" - 18"
10. Additional requirement	-
11. Weight	-
12. Dimension	-

Commodity Code	F-600-LL
Specs	E30
1. Flange type	Blind Flange
2. Material	ASTM B564 (UNS N06625)
3. Standard	-
4. Pressure class	Class 600
5. Flange facing	Raised Face
6. Face finishing	125-250 µin. surface finish
7. Coating	-
8. Schedule (SCH) or thickness	-
9. Size Range (NPS)	½" - 3"
10. Additional requirement	-
11. Weight	-
12. Dimension	-

Commodity Code	F-600-LX
Specs	E3
1. Flange type	Blind Flange
2. Material	ASTM A182 Gr F316/316L
3. Standard	-
4. Pressure class	Class 600
5. Flange facing	Raised Face
6. Face finishing	125-250 µin. surface finish
7. Coating	-
8. Schedule (SCH) or thickness	-
9. Size Range (NPS)	½" - 32"
10. Additional requirement	-
11. Weight	-
12. Dimension	-

Commodity Code	F-600-S3
Specs	
1. Flange type	Blind Flange
2. Material	ASTM A350 Gr LF2 Class 1
3. Standard	-
4. Pressure class	Class 600
5. Flange facing	Ring Type Joint
6. Face finishing	Surface finish not exceed 63 µin.
7. Coating	-
8. Schedule (SCH) or thickness	-
9. Size Range (NPS)	-
10. Additional requirement	-
11. Weight	-
12. Dimension	-

Commodity Code	F-600-S7
Specs	
1. Flange type	Blind Flange
2. Material	ASTM A182 Gr F316L
3. Standard	-
4. Pressure class	Class 600
5. Flange facing	Ring Type Joint
6. Face finishing	Surface finish not exceed 63 µin.
7. Coating	-
8. Schedule (SCH) or thickness	-
9. Size Range (NPS)	-
10. Additional requirement	-
11. Weight	-
12. Dimension	-

Commodity Code	F-600-SB
Specs	
1. Flange type	Blind Flange
2. Material	ASTM A105 Cladded
3. Standard	-
4. Pressure class	Class 600
5. Flange facing	Ring Type Joint
6. Face finishing	Surface finish not exceed 63 µin.
7. Coating	Inconel (UNS N06625) clad
8. Schedule (SCH) or thickness	-
9. Size Range (NPS)	-
10. Additional requirement	-
11. Weight	-
12. Dimension	-



Commodity Code	F-600-SC
Specs	
1. Flange type	Blind Flange
2. Material	ASTM A694 Gr F65
3. Standard	-
4. Pressure class	Class 600
5. Flange facing	Ring Type Joint
6. Face finishing	Surface finish not exceed 63 µin.
7. Coating	-
8. Schedule (SCH) or thickness	-
9. Size Range (NPS)	-
10. Additional requirement	-
11. Weight	-
12. Dimension	-

Commodity Code	F-600-SE
Specs	
1. Flange type	Blind Flange
2. Material	ASTM A350 Gr LF3 Cladded
3. Standard	-
4. Pressure class	Class 600
5. Flange facing	Ring Type Joint
6. Face finishing	Surface finish not exceed 63 µin.
7. Coating	Inconel (UNS N06625) clad
8. Schedule (SCH) or thickness	-
9. Size Range (NPS)	-
10. Additional requirement	-
11. Weight	-
12. Dimension	-

Commodity Code	F-600-SG
Specs	
1. Flange type	Blind Flange
2. Material	ASTM A182 Gr F51
3. Standard	-
4. Pressure class	Class 600
5. Flange facing	Ring Type Joint
6. Face finishing	Surface finish not exceed 63 µin.
7. Coating	-
8. Schedule (SCH) or thickness	-
9. Size Range (NPS)	-
10. Additional requirement	-
11. Weight	-
12. Dimension	-

Commodity Code	F-600-SL
Specs	
1. Flange type	Blind Flange
2. Material	ASTM B564 (UNS N06625)
3. Standard	-
4. Pressure class	Class 600
5. Flange facing	Ring Type Joint
6. Face finishing	Surface finish not exceed 63 µin.
7. Coating	-
8. Schedule (SCH) or thickness	-
9. Size Range (NPS)	-
10. Additional requirement	-
11. Weight	-
12. Dimension	-

Commodity Code	F-900-S3
Specs	F6
1. Flange type	Blind Flange
2. Material	ASTM A350 Gr LF2 Class 1
3. Standard	-
4. Pressure class	Class 900
5. Flange facing	Ring Type Joint
6. Face finishing	Surface finish not exceed 63 µin.
7. Coating	-
8. Schedule (SCH) or thickness	-
9. Size Range (NPS)	3" - 20"
10. Additional requirement	-
11. Weight	-
12. Dimension	-

Commodity Code	F-900-SB
Specs	
1. Flange type	Blind Flange
2. Material	ASTM A105 Cladded
3. Standard	-
4. Pressure class	Class 900
5. Flange facing	Ring Type Joint
6. Face finishing	Surface finish not exceed 63 µin.
7. Coating	Inconel (UNS N06625) clad
8. Schedule (SCH) or thickness	-
9. Size Range (NPS)	-
10. Additional requirement	-
11. Weight	-
12. Dimension	-

B12.4.4 WELDING NECK FLANGE API 6BX

Commodity Code	F-10000-6X												
Specs	C3												
1. Flange type	Welding Neck Flange API 6BX												
2. Material	ASTM A182 Gr F316/316L												
3. Standard	API 6A												
4. Pressure class	API 10000												
5. Flange facing	studded type 6BX (stud and nuts included)												
6. Face finishing	Surface finish not exceed 63 µin.												
7. Coating	-												
8. Schedule (SCH) or thickness	-												
9. Size Range (NPS)	<table border="1"> <thead> <tr> <th>ASME Size</th> <th>API Size</th> </tr> </thead> <tbody> <tr><td>2"</td><td>1 1/2"</td></tr> <tr><td>3"</td><td>2 1/2"</td></tr> <tr><td>4"</td><td>3 1/2"</td></tr> <tr><td>6"</td><td>4 1/2"</td></tr> <tr><td>8" - 10"</td><td>7 1/2"</td></tr> </tbody> </table>	ASME Size	API Size	2"	1 1/2"	3"	2 1/2"	4"	3 1/2"	6"	4 1/2"	8" - 10"	7 1/2"
ASME Size	API Size												
2"	1 1/2"												
3"	2 1/2"												
4"	3 1/2"												
6"	4 1/2"												
8" - 10"	7 1/2"												
10. Additional requirement	-												
11. Weight	-												
12. Dimension	-												

B12.4.5 SOCKET WELD FLANGE (SW)

Commodity Code	F-1500-Q2
Specs	G10
1. Flange type	Socket Weld Flange (SW)
2. Material	ASTM A105
3. Standard	ASME B16.5
4. Pressure class	Class 1500
5. Flange facing	Ring Type Joint
6. Face finishing	Surface finish not exceed 63 µin.
7. Coating	-
8. Schedule (SCH) or thickness	-
9. Size Range (NPS)	1/2" - 1 1/2"
10. Additional requirement	-
11. Weight	-
12. Dimension	-

Commodity Code	F-1500-Q3
Specs	F6
1. Flange type	Socket weld Flange (SW)
2. Material	ASTM A350 Gr LF2 Class 1
3. Standard	ASME B16.5
4. Pressure class	Class 1500
5. Flange facing	Ring Type Joint
6. Face finishing	Surface finish not exceed 63 µin.
7. Coating	-
8. Schedule (SCH) or thickness	-
9. Size Range (NPS)	1/2" - 1 1/2"
10. Additional requirement	-
11. Weight	-
12. Dimension	-

Commodity Code	F-1500-QG
Specs	G16P G16
1. Flange type	Socket Weld Flange (SW)
2. Material	ASTM A182 Gr F51
3. Standard	ASME B16.5
4. Pressure class	Class 1500
5. Flange facing	Ring Type Joint
6. Face finishing	Surface finish not exceed 63 µin.
7. Coating	-
8. Schedule (SCH) or thickness	-
9. Size Range (NPS)	1/2" - 1 1/2"
10. Additional requirement	-
11. Weight	-
12. Dimension	-

Commodity Code	F-1500-QX
Specs	G3
1. Flange type	Socket Weld Flange (SW)
2. Material	ASTM A182 Gr F316/316L
3. Standard	ASME B16.5
4. Pressure class	Class 1500
5. Flange facing	Ring Type Joint
6. Face finishing	Surface finish not exceed 63 µin.
7. Coating	-
8. Schedule (SCH) or thickness	-
9. Size Range (NPS)	1/2" - 1 1/2"
10. Additional requirement	-
11. Weight	-
12. Dimension	-

Commodity Code	F-150-J2
Specs	B4 B9 B10
1. Flange type	Socket Weld Flange (SW)
2. Material	ASTM A105
3. Standard	ASME B16.5
4. Pressure class	Class 150
5. Flange facing	Raised Face
6. Face finishing	125-250 µin. surface finish
7. Coating	-
8. Schedule (SCH) or thickness	-
9. Size Range (NPS)	1/2" - 1 1/2"
10. Additional requirement	-
11. Weight	-
12. Dimension	-

Commodity Code	F-150-J3
Specs	B6
1. Flange type	Socket weld Flange (SW)
2. Material	ASTM A350 Gr LF2 Class 1
3. Standard	ASME B16.5
4. Pressure class	Class 150
5. Flange facing	Raised Face
6. Face finishing	125-250 µin. surface finish
7. Coating	-
8. Schedule (SCH) or thickness	-
9. Size Range (NPS)	1/2" - 1 1/2"
10. Additional requirement	-
11. Weight	-
12. Dimension	-

Commodity Code	F-150-JG
Specs	B16
1. Flange type	Socket Weld Flange (SW)
2. Material	ASTM A182 Gr F51
3. Standard	ASME B16.5
4. Pressure class	Class 150
5. Flange facing	Raised Face
6. Face finishing	125-250 µin. surface finish
7. Coating	-
8. Schedule (SCH) or thickness	-
9. Size Range (NPS)	1/2" - 1 1/2"
10. Additional requirement	-
11. Weight	-
12. Dimension	-

Commodity Code	F-150-JH
Specs	B12
1. Flange type	Socket weld Flange (SW)
2. Material	ASTM A182 Gr F55
3. Standard	ASME B16.5
4. Pressure class	Class 150
5. Flange facing	Raised Face
6. Face finishing	125-250 µin. surface finish
7. Coating	-
8. Schedule (SCH) or thickness	-
9. Size Range (NPS)	1/2" - 1 1/2"
10. Additional requirement	-
11. Weight	-
12. Dimension	-

Commodity Code	F-150-JL
Specs	B30
1. Flange type	Socket weld Flange (SW)
2. Material	ASTM B564 (UNS N06625)
3. Standard	ASME B16.5
4. Pressure class	Class 150
5. Flange facing	Raised Face
6. Face finishing	125-250 µin. surface finish
7. Coating	-
8. Schedule (SCH) or thickness	-
9. Size Range (NPS)	1/2" - 1 1/2"
10. Additional requirement	-
11. Weight	-
12. Dimension	-

Commodity Code	F-150-JX
Specs	B3
1. Flange type	Socket weld Flange (SW)
2. Material	ASTM A182 Gr F316/316L
3. Standard	ASME B16.5
4. Pressure class	Class 150
5. Flange facing	Raised Face
6. Face finishing	125-250 µin. surface finish
7. Coating	-
8. Schedule (SCH) or thickness	-
9. Size Range (NPS)	1/2" - 1 1/2"
10. Additional requirement	-
11. Weight	-
12. Dimension	-

Commodity Code	F-300-J2
Specs	C10
1. Flange type	Socket weld Flange (SW)
2. Material	ASTM A105
3. Standard	ASME B16.5
4. Pressure class	Class 300
5. Flange facing	Raised Face
6. Face finishing	125-250 µin. surface finish
7. Coating	-
8. Schedule (SCH) or thickness	-
9. Size Range (NPS)	1/2" - 1 1/2"
10. Additional requirement	-
11. Weight	-
12. Dimension	-

Commodity Code	F-300-J3
Specs	C6
1. Flange type	Socket weld Flange (SW)
2. Material	ASTM A350 Gr LF2 Class 1
3. Standard	ASME B16.5
4. Pressure class	Class 300
5. Flange facing	Raised Face
6. Face finishing	125-250 µin. surface finish
7. Coating	-
8. Schedule (SCH) or thickness	-
9. Size Range (NPS)	1/2" - 1 1/2"
10. Additional requirement	-
11. Weight	-
12. Dimension	-

Commodity Code	F-300-JG
Specs	C16
1. Flange type	Socket Weld Flange (SW)
2. Material	ASTM A182 Gr F51
3. Standard	ASME B16.5
4. Pressure class	Class 300
5. Flange facing	Raised Face
6. Face finishing	125-250 µin. surface finish
7. Coating	-
8. Schedule (SCH) or thickness	-
9. Size Range (NPS)	1/2" - 1 1/2"
10. Additional requirement	-
11. Weight	-
12. Dimension	-

Commodity Code	F-300-JL
Specs	C30
1. Flange type	Socket weld Flange (SW)
2. Material	ASTM B564 (UNS N06625)
3. Standard	ASME B16.5
4. Pressure class	Class 300
5. Flange facing	Raised Face
6. Face finishing	125-250 µin. surface finish
7. Coating	-
8. Schedule (SCH) or thickness	-
9. Size Range (NPS)	1/2" - 3"
10. Additional requirement	-
11. Weight	-
12. Dimension	-

Commodity Code	F-300-JX
Specs	C3
1. Flange type	Socket weld Flange (SW)
2. Material	ASTM A182 Gr F316/316L
3. Standard	ASME B16.5
4. Pressure class	Class 300
5. Flange facing	Raised Face
6. Face finishing	125-250 µin. surface finish
7. Coating	-
8. Schedule (SCH) or thickness	-
9. Size Range (NPS)	1/2" - 1 1/2"
10. Additional requirement	-
11. Weight	-
12. Dimension	-

Commodity Code	F-300-QW
Specs	
1. Flange type	Socket Weld Flange (SW)
2. Material	ASTM A182 Gr F310H
3. Standard	ASME B16.5
4. Pressure class	Class 300
5. Flange facing	Ring Type Joint
6. Face finishing	Surface finish not exceed 63 µin.
7. Coating	-
8. Schedule (SCH) or thickness	-
9. Size Range (NPS)	1/2" - 1 1/2"
10. Additional requirement	-
11. Weight	-
12. Dimension	-

Commodity Code	F-600-J2
Specs	E34
1. Flange type	Socket weld Flange (SW)
2. Material	ASTM A105
3. Standard	ASME B16.5
4. Pressure class	Class 600
5. Flange facing	Raised Face
6. Face finishing	125-250 µin. surface finish
7. Coating	-
8. Schedule (SCH) or thickness	-
9. Size Range (NPS)	½" - 1 ½"
10. Additional requirement	-
11. Weight	-
12. Dimension	-

Commodity Code	F-600-J3
Specs	E6 E19
1. Flange type	Socket weld Flange (SW)
2. Material	ASTM A350 Gr LF2 Class 1
3. Standard	ASME B16.5
4. Pressure class	Class 600
5. Flange facing	Raised Face
6. Face finishing	125-250 µin. surface finish
7. Coating	-
8. Schedule (SCH) or thickness	-
9. Size Range (NPS)	½" - 1 ½"
10. Additional requirement	-
11. Weight	-
12. Dimension	-

Commodity Code	F-600-JG
Specs	E16
1. Flange type	Socket weld Flange (SW)
2. Material	ASTM A182 Gr F51
3. Standard	ASME B16.5
4. Pressure class	Class 600
5. Flange facing	Raised Face
6. Face finishing	125-250 µin. surface finish
7. Coating	-
8. Schedule (SCH) or thickness	-
9. Size Range (NPS)	½" - 1 ½"
10. Additional requirement	-
11. Weight	-
12. Dimension	-

Commodity Code	F-600-JL
Specs	E30
1. Flange type	Socket weld Flange (SW)
2. Material	ASTM B564 (UNS N06625)
3. Standard	ASME B16.5
4. Pressure class	Class 600
5. Flange facing	Raised Face
6. Face finishing	125-250 µin. surface finish
7. Coating	-
8. Schedule (SCH) or thickness	-
9. Size Range (NPS)	½" - 1 ½"
10. Additional requirement	-
11. Weight	-
12. Dimension	-

Commodity Code	F-600-JX
Specs	E3
1. Flange type	Socket weld Flange (SW)
2. Material	ASTM A182 Gr F316/316L
3. Standard	ASME B16.5
4. Pressure class	Class 600
5. Flange facing	Raised Face
6. Face finishing	125-250 µin. surface finish
7. Coating	-
8. Schedule (SCH) or thickness	-
9. Size Range (NPS)	½" - 1 ½"
10. Additional requirement	-
11. Weight	-
12. Dimension	-

Commodity Code	F-600-Q3
Specs	
1. Flange type	Socket weld Flange (SW)
2. Material	ASTM A350 Gr LF2 Class 1
3. Standard	ASME B16.5
4. Pressure class	Class 600
5. Flange facing	Ring Type Joint
6. Face finishing	Surface finish not exceed 63 µin.
7. Coating	-
8. Schedule (SCH) or thickness	-
9. Size Range (NPS)	-
10. Additional requirement	-
11. Weight	-
12. Dimension	-

Commodity Code	F-600-Q7
Specs	
1. Flange type	Socket weld Flange (SW)
2. Material	ASTM A182 Gr F316L
3. Standard	ASME B16.5
4. Pressure class	Class 600
5. Flange facing	Ring Type Joint
6. Face finishing	Surface finish not exceed 63 µin.
7. Coating	-
8. Schedule (SCH) or thickness	-
9. Size Range (NPS)	-
10. Additional requirement	-
11. Weight	-
12. Dimension	-

Commodity Code	F-600-QG
Specs	
1. Flange type	Socket weld Flange (SW)
2. Material	ASTM A182 Gr F51
3. Standard	ASME B16.5
4. Pressure class	Class 600
5. Flange facing	Ring Type Joint
6. Face finishing	Surface finish not exceed 63 µin.
7. Coating	-
8. Schedule (SCH) or thickness	-
9. Size Range (NPS)	-
10. Additional requirement	-
11. Weight	-
12. Dimension	-

Commodity Code	F-600-QL
Specs	
1. Flange type	Socket weld Flange (SW)
2. Material	ASTM B564 (UNS N06625)
3. Standard	ASME B16.5
4. Pressure class	Class 600
5. Flange facing	Ring Type Joint
6. Face finishing	Surface finish not exceed 63 µin.
7. Coating	-
8. Schedule (SCH) or thickness	-
9. Size Range (NPS)	-
10. Additional requirement	-
11. Weight	-
12. Dimension	-

B12.4.6 BACKING FLANGE

Commodity Code	F-16-YV
Specs	B23 B26 B28
1. Flange type	Backing Flange
2. Material	ASTM A105 Epoxy coated
3. Standard	Drilling acc. B16.5/B16.47 CL150
4. Pressure class	16 bar
5. Flange facing	Raised Face
6. Face finishing	-
7. Coating	Epoxy coated
8. Schedule (SCH) or thickness	-
9. Size Range (NPS)	1" - 48"
10. Additional requirement	-
11. Weight	-
12. Dimension	-

Commodity Code	F-20-Y2
Specs	B7
1. Flange type	Backing Flange
2. Material	ASTM A105
3. Standard	EEMUA 234
4. Pressure class	20 bar
5. Flange facing	Raised Face
6. Face finishing	-
7. Coating	Epoxy coated
8. Schedule (SCH) or thickness	-
9. Size Range (NPS)	2" - 36"
10. Additional requirement	-
11. Weight	-
12. Dimension	-

Commodity Code	F-25-YV
Specs	C23
1. Flange type	Backing Flange
2. Material	ASTM A105 Epoxy coated
3. Standard	Drilling acc. B16.5/B16.47 CL300
4. Pressure class	25 bar
5. Flange facing	Raised Face
6. Face finishing	-
7. Coating	Epoxy coated
8. Schedule (SCH) or thickness	-
9. Size Range (NPS)	1" - 28"
10. Additional requirement	-
11. Weight	-
12. Dimension	-

B12.4.7 SLIP ON FLANGE (SO)

Commodity Code	F-20-HM
Specs	B7
1. Flange type	Slip On Flange (SO)
2. Material	Cu-Ni 90/10 (UNS 7060X)
3. Standard	EEMUA 234
4. Pressure class	20 bar
5. Flange facing	Raised Face
6. Face finishing	125-250 µin. surface finish
7. Coating	-
8. Schedule (SCH) or thickness	-
9. Size Range (NPS)	½" - 1 ½"
10. Additional requirement	-
11. Weight	-
12. Dimension	-

B12.4.8 WELDING NECK COMPACT FLANGE

Commodity Code	F-2500-UD
Specs	H30
1. Flange type	Welding Neck Compact Flange
2. Material	ASTM A694 Gr F65 Clad
3. Standard	ISO 27509
4. Pressure class	Class 2500
5. Flange facing	IX seal ring
6. Face finishing	Surface finish accordig to ISO 4287
7. Coating	Inconel (UNS N06625) clad
8. Schedule (SCH) or thickness	-
9. Size Range (NPS)	4" - 24"
10. Additional requirement	-
11. Weight	-
12. Dimension	-

Commodity Code	F-2500-UG
Specs	H16
1. Flange type	Welding Neck Compact Flange
2. Material	ASTM A182 Gr F51
3. Standard	ISO 27509
4. Pressure class	Class 2500
5. Flange facing	IX seal ring
6. Face finishing	Surface finish accordig to ISO 4287
7. Coating	-
8. Schedule (SCH) or thickness	-
9. Size Range (NPS)	1" - 24"
10. Additional requirement	-
11. Weight	-
12. Dimension	-

Commodity Code	F-2500-UH
Specs	H12P H12
1. Flange type	Welding Neck Compact Flange
2. Material	ASTM A182 Gr F55
3. Standard	ISO 27509
4. Pressure class	Class 2500
5. Flange facing	IX seal ring
6. Face finishing	Surface finish accordig to ISO 4287
7. Coating	-
8. Schedule (SCH) or thickness	-
9. Size Range (NPS)	1" - 24"
10. Additional requirement	-
11. Weight	-
12. Dimension	-

Commodity Code	F-2500-UL
Specs	H30
1. Flange type	Welding Neck Compact Flange
2. Material	ASTM B564 (UNS N06625)
3. Standard	ISO 27509
4. Pressure class	Class 2500
5. Flange facing	IX seal ring
6. Face finishing	Surface finish accordig to ISO 4287
7. Coating	-
8. Schedule (SCH) or thickness	-
9. Size Range (NPS)	1" - 6"
10. Additional requirement	-
11. Weight	-
12. Dimension	-

Commodity Code	F-2500-UX
Specs	H3
1. Flange type	Welding Neck Compact Flange
2. Material	ASTM A182 Gr F316/316L
3. Standard	ISO 27509
4. Pressure class	Class 2500
5. Flange facing	IX seal ring
6. Face finishing	Surface finish accordig to ISO 4287
7. Coating	-
8. Schedule (SCH) or thickness	-
9. Size Range (NPS)	1" - 16"
10. Additional requirement	-
11. Weight	-
12. Dimension	-

B12.4.9 BLIND COMPACT FLANGE





Commodity Code	F-2500-VD
Specs	H30
1. Flange type	Blind Compact Flange
2. Material	ASTM A694 Gr F65 Cladded
3. Standard	ISO 27509
4. Pressure class	Class 2500
5. Flange facing	IX seal ring
6. Face finishing	Surface finish accordig to ISO 4287
7. Coating	Inconel (UNS N06625) clad
8. Schedule (SCH) or thickness	-
9. Size Range (NPS)	4" - 24"
10. Additional requirement	-
11. weight	-
12. Dimension	-

Commodity Code	F-2500-VG
Specs	H16
1. Flange type	Blind Compact Flange
2. Material	ASTM A182 Gr F51
3. Standard	ISO 27509
4. Pressure class	Class 2500
5. Flange facing	IX seal ring
6. Face finishing	Surface finish accordig to ISO 4287
7. Coating	-
8. Schedule (SCH) or thickness	-
9. Size Range (NPS)	1" - 24"
10. Additional requirement	-
11. weight	-
12. Dimension	-

Commodity Code	F-2500-VH
Specs	H12P H12
1. Flange type	Blind Compact Flange
2. Material	ASTM A182 Gr F55
3. Standard	ISO 27509
4. Pressure class	Class 2500
5. Flange facing	IX seal ring
6. Face finishing	Surface finish accordig to ISO 4287
7. Coating	-
8. Schedule (SCH) or thickness	-
9. Size Range (NPS)	1" - 24"
10. Additional requirement	-
11. weight	-
12. Dimension	-

Commodity Code	F-2500-VL
Specs	H30
1. Flange type	Blind Compact Flange
2. Material	ASTM B564 (UNS N06625)
3. Standard	ISO 27509
4. Pressure class	Class 2500
5. Flange facing	IX seal ring
6. Face finishing	Surface finish accordig to ISO 4287
7. Coating	-
8. Schedule (SCH) or thickness	-
9. Size Range (NPS)	1" - 6"
10. Additional requirement	-
11. weight	-
12. Dimension	-

Commodity Code	F-2500-VX
Specs	H3
1. Flange type	Blind Compact Flange
2. Material	ASTM A182 Gr F316/316L
3. Standard	ISO 27509
4. Pressure class	Class 2500
5. Flange facing	IX seal ring
6. Face finishing	Surface finish accordig to ISO 4287
7. Coating	-
8. Schedule (SCH) or thickness	-
9. Size Range (NPS)	1" - 16"
10. Additional requirement	-
11. weight	-
12. Dimension	-

B12.4.10 HYDRAULIC ONE-PIECE FLANGE

Commodity Code	F-350-3X
Specs	B3 C3 E3 G3
1. Flange type	Hydraulic One-Piece Flange
2. Material	ASTM A182 Gr F316/316L
3. Standard	ISO 6162-1
4. Pressure class	max 350 bar
5. Flange facing	-
6. Face finishing	-
7. Coating	-
8. Schedule (SCH) or thickness	-
9. Size Range (NPS)	½" - 3"
10. Additional requirement	-
11. weight	-
12. Dimension	-

Commodity Code	F-420-3X
Specs	H3
1. Flange type	Hydraulic One-Piece Flange
2. Material	ASTM A182 Gr F316/316L
3. Standard	ISO 6162-2
4. Pressure class	max 420 bar
5. Flange facing	-
6. Face finishing	-
7. Coating	-
8. Schedule (SCH) or thickness	-
9. Size Range (NPS)	1" - 3"
10. Additional requirement	-
11. weight	-
12. Dimension	-

5. GASKET

B12.5.1 FLAT GASKET

Commodity Code	J-150-C3
Specs	B22
Commodity Code	J-150-PC
Specs	B11 B26

Commodity Code	J-150-CC
Specs	B14 B27
Commodity Code	J-300-P3
Specs	C23

Commodity Code	J-150-P3
Specs	B23 B28
Commodity Code	J-300-PA
Specs	C8

Commodity Code	J-150-P4
Specs	B7
Commodity Code	J-300-PC
Specs	C11

B12.5.2 ISOLATION GASKET KIT

Commodity Code	J-1500-HZ
Specs	
1. Gasket type	Isolation Gasket Kit
2. Gasket material (1 pc)	AISI 316 core with G-10 composite facing layers, and PTFE sealing ring.
3. Bolt sleeves material (1 per bolt)	NEMA Grade G-10
4. Non metallic washers material (2 per bolt)	NEMA Grade G-10
5. Metallic washers material (2 per bolt)	Hardened Carbon Steel, Zn-Ni coated
6. Gasket standard	-
7. Thickness	-
8. Temperature	150 °C
9. Flange Type	Class 1500
10. Size Range (NPS)	-
11. Additional requirements	-
12. Weight	-
13. Dimension	-

Commodity Code	J-150-DA
Specs	
1. Gasket type	Isolation Gasket Kit
2. Gasket material (1 pc)	Aramid fiber with NBR rubber
3. Bolt sleeves material (1 per bolt)	NEMA Grade G-10
4. Non metallic washers material (2 per bolt)	NEMA Grade G-10
5. Metallic washers material (2 per bolt)	Hardened Carbon Steel, Zn-Ni coated
6. Gasket standard	-
7. Thickness	-
8. Temperature	75 °C
9. Flange Type	Class 150
10. Size Range (NPS)	-
11. Additional requirements	-
12. Weight	-
13. Dimension	-

Commodity Code	J-150-DY
Specs	
1. Gasket type	Isolation Gasket Kit
2. Gasket material (1 pc)	Phenolic gasket with Nitrile rubber facing layers
3. Bolt sleeves material (1 per bolt)	Mylar
4. Non metallic washers material (2 per bolt)	Phenolic
5. Metallic washers material (2 per bolt)	Hardened Carbon Steel, Zn-Ni coated
6. Gasket standard	-
7. Thickness	-
8. Temperature	75 °C
9. Flange Type	Class 150
10. Size Range (NPS)	-
11. Additional requirements	-
12. Weight	-
13. Dimension	-

Commodity Code	J-150-FA
Specs	
1. Gasket type	Isolation Gasket Kit
2. Gasket material (1 pc)	Aramid fiber with NBR rubber
3. Bolt sleeves material (1 per bolt)	NEMA Grade G-10
4. Non metallic washers material (2 per bolt)	NEMA Grade G-10
5. Metallic washers material (2 per bolt)	Hardened Carbon Steel, Zn-Ni coated
6. Gasket standard	-
7. Thickness	-
8. Temperature	75 °C
9. Flange Type	Class 150
10. Size Range (NPS)	-
11. Additional requirements	-
12. Weight	-
13. Dimension	-

Commodity Code	J-150-FX
Specs	
1. Gasket type	Isolation Gasket Kit
2. Gasket material (1 pc)	AISI 316 grooved core with PTFE facing layers
3. Bolt sleeves material (1 per bolt)	NEMA Grade G-10
4. Non metallic washers material (2 per bolt)	NEMA Grade G-10
5. Metallic washers material (2 per bolt)	Hardened Carbon Steel, Zn-Ni coated
6. Gasket standard	-
7. Thickness	-
8. Temperature	150 °C
9. Flange Type	Class 150
10. Size Range (NPS)	-
11. Additional requirements	-
12. Weight	-
13. Dimension	-

Commodity Code	J-150-FY
Specs	
1. Gasket type	Isolation Gasket Kit
2. Gasket material (1 pc)	Phenolic gasket with Nitrile rubber facing layers
3. Bolt sleeves material (1 per bolt)	Mylar
4. Non metallic washers material (2 per bolt)	Phenolic
5. Metallic washers material (2 per bolt)	Hardened Carbon Steel, Zn-Ni coated
6. Gasket standard	-
7. Thickness	-
8. Temperature	75 °C
9. Flange Type	Class 150
10. Size Range (NPS)	-
11. Additional requirements	-
12. Weight	-
13. Dimension	-

Commodity Code	J-150-FZ
Specs	
1. Gasket type	Isolation Gasket Kit
2. Gasket material (1 pc)	AISI 316 core with G-10 composite facing layers, and PTFE sealing ring.
3. Bolt sleeves material (1 per bolt)	NEMA Grade G-10
4. Non metallic washers material (2 per bolt)	NEMA Grade G-10
5. Metallic washers material (2 per bolt)	Hardened Carbon Steel, Zn-Ni coated
6. Gasket standard	-
7. Thickness	-
8. Temperature	150 °C
9. Flange Type	Class 150
10. Size Range (NPS)	-
11. Additional requirements	-
12. Weight	-
13. Dimension	-

Commodity Code	J-2500-HZ
Specs	
1. Gasket type	Isolation Gasket Kit
2. Gasket material (1 pc)	AISI 316 core with G-10 composite facing layers, and PTFE sealing ring.
3. Bolt sleeves material (1 per bolt)	NEMA Grade G-10
4. Non metallic washers material (2 per bolt)	NEMA Grade G-10
5. Metallic washers material (2 per bolt)	Hardened Carbon Steel, Zn-Ni coated
6. Gasket standard	-
7. Thickness	-
8. Temperature	150 °C
9. Flange Type	Class 2500
10. Size Range (NPS)	-
11. Additional requirements	-
12. Weight	-
13. Dimension	-

Commodity Code	J-300-FA
Specs	
1. Gasket type	Isolation Gasket Kit
2. Gasket material (1 pc)	Aramid fiber with NBR rubber
3. Bolt sleeves material (1 per bolt)	NEMA Grade G-10
4. Non metallic washers material (2 per bolt)	NEMA Grade G-10
5. Metallic washers material (2 per bolt)	Hardened Carbon Steel, Zn-Ni coated
6. Gasket standard	-
7. Thickness	-
8. Temperature	75 °C
9. Flange Type	Class 300
10. Size Range (NPS)	-
11. Additional requirements	-
12. Weight	-
13. Dimension	-

Commodity Code	J-300-FX
Specs	
1. Gasket type	Isolation Gasket Kit
2. Gasket material (1 pc)	AISI 316 grooved core with PTFE facing layers
3. Bolt sleeves material (1 per bolt)	NEMA Grade G-10
4. Non metallic washers material (2 per bolt)	NEMA Grade G-10
5. Metallic washers material (2 per bolt)	Hardened Carbon Steel, Zn-Ni coated
6. Gasket standard	-
7. Thickness	-
8. Temperature	150 °C
9. Flange Type	Class 300
10. Size Range (NPS)	-
11. Additional requirements	-
12. Weight	-
13. Dimension	-

Commodity Code	J-300-FY
Specs	
1. Gasket type	Isolation Gasket Kit
2. Gasket material (1 pc)	Phenolic gasket with Nitrile rubber facing layers
3. Bolt sleeves material (1 per bolt)	Mylar
4. Non metallic washers material (2 per bolt)	Phenolic
5. Metallic washers material (2 per bolt)	Hardened Carbon Steel, Zn-Ni coated
6. Gasket standard	-
7. Thickness	-
8. Temperature	75 °C
9. Flange Type	Class 300
10. Size Range (NPS)	-
11. Additional requirements	-
12. Weight	-
13. Dimension	-

Commodity Code	J-600-FX
Specs	
1. Gasket type	Isolation Gasket Kit
2. Gasket material (1 pc)	AISI 316 grooved core with PTFE facing layers
3. Bolt sleeves material (1 per bolt)	NEMA Grade G-10
4. Non metallic washers material (2 per bolt)	NEMA Grade G-10
5. Metallic washers material (2 per bolt)	Hardened Carbon Steel, Zn-Ni coated
6. Gasket standard	-
7. Thickness	-
8. Temperature	150 °C
9. Flange Type	Class 600
10. Size Range (NPS)	-
11. Additional requirements	-
12. Weight	-
13. Dimension	-

Commodity Code	J-600-FZ
Specs	
1. Gasket type	Isolation Gasket Kit
2. Gasket material (1 pc)	AISI 316 core with G-10 composite facing layers, and PTFE sealing ring.
3. Bolt sleeves material (1 per bolt)	NEMA Grade G-10
4. Non metallic washers material (2 per bolt)	NEMA Grade G-10
5. Metallic washers material (2 per bolt)	Hardened Carbon Steel, Zn-Ni coated
6. Gasket standard	-
7. Thickness	-
8. Temperature	150 °C
9. Flange Type	Class 600
10. Size Range (NPS)	-
11. Additional requirements	-
12. Weight	-
13. Dimension	-

Commodity Code	J-900-HZ
Specs	
1. Gasket type	Isolation Gasket Kit
2. Gasket material (1 pc)	AISI 316 core with G-10 composite facing layers, and PTFE sealing ring.
3. Bolt sleeves material (1 per bolt)	NEMA Grade G-10
4. Non metallic washers material (2 per bolt)	NEMA Grade G-10
5. Metallic washers material (2 per bolt)	Hardened Carbon Steel, Zn-Ni coated
6. Gasket standard	-
7. Thickness	-
8. Temperature	150 °C
9. Flange Type	Class 900
10. Size Range (NPS)	-
11. Additional requirements	-
12. Weight	-
13. Dimension	-

B12.5.3 SPIRAL-WOUND GASKET

Commodity Code	J-150-EH
Specs	B3 B4 B6 B9 B10
1. Gasket type	Spiral-wound Gasket
2. Material	AISI 316 Stainless Steel windings with flexible graphite filler
3. Gasket standard	ASME B16.20
4. Thickness	4,4 mm
5. Centering and inner rings	Centering and inner rings in AISI 316
6. Flange Type	½" - 24" 1409, Class 150, Raised Face 26" - 44" 945, Class 150, Raised Face
7. Size Range (NPS)	½" - 44"
8. Additional requirements	-
9. Weight	-
10. Dimension	-

Commodity Code	J-150-EL
Specs	B12 B16
1. Gasket type	Spiral-wound Gasket
2. Material	Duplex SS (UNS S31803) windings with flexible graphite filler
3. Gasket standard	ASME B16.20
4. Thickness	4,4 mm
5. Centering and inner rings	Centering ring in AISI 316 and inner ring in Duplex Stainless Steel
6. Flange Type	½" - 24" 1409, Class 150, Raised Face, ASME B16.5, Class 150, Raised Face 26" - 40" 945, Class 150, Raised Face, ASME B16.47 A, Class 150, Raised Face 42" - 60" ASME B16.47 A, Class 150, Raised Face
7. Size Range (NPS)	½" - 60"
8. Additional requirements	-
9. Weight	-
10. Dimension	-

Commodity Code	J-150-EM
Specs	B30
1. Gasket type	Spiral-wound Gasket
2. Material	Inconel 625 windings with flexible graphite filler
3. Gasket standard	ASME B16.20
4. Thickness	4,4 mm
5. Centering and inner rings	Centering ring in AISI 316 and inner ring in Inconel 625
6. Flange Type	½" - 24" 1409, Class 150, Raised Face 26" - 30" 945, Class 150, Raised Face
7. Size Range (NPS)	½" - 30"
8. Additional requirements	-
9. Weight	-
10. Dimension	-

Commodity Code	J-300-EH
Specs	C3 C6 C10
1. Gasket type	Spiral-wound Gasket
2. Material	AISI 316 Stainless Steel windings with flexible graphite filler
3. Gasket standard	ASME B16.20
4. Thickness	4,4 mm
5. Centering and inner rings	Centering and inner rings in AISI 316
6. Flange Type	½" - 24" 1409, Class 300, Raised Face, ASME B16.5, Class 300, Raised Face 26" - 32" 945, Class 300, Raised Face, ASME B16.47 A, Class 300, Raised Face 34" - 38" 945, Class 300, Raised Face
7. Size Range (NPS)	½" - 38"
8. Additional requirements	-
9. Weight	-
10. Dimension	-

Commodity Code	J-300-EL						
Specs	C16						
1. Gasket type	Spiral-wound Gasket						
2. Material	Duplex SS (UNS S31803) windings with flexible graphite filler						
3. Gasket standard	ASME B16.20						
4. Thickness	4,4 mm						
5. Centering and Inner rings	Centering ring in AISI 316 and inner ring in Duplex Stainless Steel						
6. Flange Type	<table border="1"> <tr> <td>1/2" - 24"</td> <td>1409, Class 300, Raised Face, ASME B16.5, Class 300, Raised Face</td> </tr> <tr> <td>26" - 32"</td> <td>945, Class 300, Raised Face, ASME B16.47 A, Class 300, Raised Face</td> </tr> <tr> <td>34" - 60"</td> <td>ASME B16.47 A, Class 300, Raised Face</td> </tr> </table>	1/2" - 24"	1409, Class 300, Raised Face, ASME B16.5, Class 300, Raised Face	26" - 32"	945, Class 300, Raised Face, ASME B16.47 A, Class 300, Raised Face	34" - 60"	ASME B16.47 A, Class 300, Raised Face
1/2" - 24"	1409, Class 300, Raised Face, ASME B16.5, Class 300, Raised Face						
26" - 32"	945, Class 300, Raised Face, ASME B16.47 A, Class 300, Raised Face						
34" - 60"	ASME B16.47 A, Class 300, Raised Face						
7. Size Range (NPS)	1/2" - 60"						
8. Additional requirements	-						
9. Weight	-						
10. Dimension	-						

Commodity Code	J-300-EM						
Specs	C30						
1. Gasket type	Spiral-wound Gasket						
2. Material	Inconel 625 windings with flexible graphite filler						
3. Gasket standard	ASME B16.20						
4. Thickness	4,4 mm						
5. Centering and Inner rings	Centering ring in AISI 316 and inner ring in Inconel 625						
6. Flange Type	<table border="1"> <tr> <td>1/2" - 24"</td> <td>1409, Class 300, Raised Face, ASME B16.5, Class 300, Raised Face</td> </tr> <tr> <td>26"</td> <td>945, Class 300, Raised Face, ASME B16.47 A, Class 300, Raised Face</td> </tr> <tr> <td>28" - 30"</td> <td>945, Class 300, Raised Face</td> </tr> </table>	1/2" - 24"	1409, Class 300, Raised Face, ASME B16.5, Class 300, Raised Face	26"	945, Class 300, Raised Face, ASME B16.47 A, Class 300, Raised Face	28" - 30"	945, Class 300, Raised Face
1/2" - 24"	1409, Class 300, Raised Face, ASME B16.5, Class 300, Raised Face						
26"	945, Class 300, Raised Face, ASME B16.47 A, Class 300, Raised Face						
28" - 30"	945, Class 300, Raised Face						
7. Size Range (NPS)	1/2" - 30"						
8. Additional requirements	-						
9. Weight	-						
10. Dimension	-						

Commodity Code	J-600-EH				
Specs	E3 E6 E8 E19 E34				
1. Gasket type	Spiral-wound Gasket				
2. Material	AISI 316 Stainless Steel windings with flexible graphite filler				
3. Gasket standard	ASME B16.20				
4. Thickness	4,4 mm				
5. Centering and Inner rings	Centering and inner rings in AISI 316				
6. Flange Type	<table border="1"> <tr> <td>1/2" - 24"</td> <td>1409, Class 600, Raised Face, ASME B16.5, Class 600, Raised Face</td> </tr> <tr> <td>26" - 32"</td> <td>945, Class 600, Raised Face</td> </tr> </table>	1/2" - 24"	1409, Class 600, Raised Face, ASME B16.5, Class 600, Raised Face	26" - 32"	945, Class 600, Raised Face
1/2" - 24"	1409, Class 600, Raised Face, ASME B16.5, Class 600, Raised Face				
26" - 32"	945, Class 600, Raised Face				
7. Size Range (NPS)	1/2" - 32"				
8. Additional requirements	-				
9. Weight	-				
10. Dimension	-				

Commodity Code	J-600-EL						
Specs	E16						
1. Gasket type	Spiral-wound Gasket						
2. Material	Duplex SS (UNS S31803) windings with flexible graphite filler						
3. Gasket standard	ASME B16.20						
4. Thickness	4,4 mm						
5. Centering and Inner rings	Centering ring in AISI 316 and inner ring in Duplex Stainless Steel						
6. Flange Type	<table border="1"> <tr> <td>1/2" - 18"</td> <td>1409, Class 600, Raised Face, ASME B16.5, Class 600, Raised Face</td> </tr> <tr> <td>20" - 24"</td> <td>ASME B16.5, Class 600, Raised Face</td> </tr> <tr> <td>26" - 60"</td> <td>ASME B16.47 A, Class 600, Raised Face</td> </tr> </table>	1/2" - 18"	1409, Class 600, Raised Face, ASME B16.5, Class 600, Raised Face	20" - 24"	ASME B16.5, Class 600, Raised Face	26" - 60"	ASME B16.47 A, Class 600, Raised Face
1/2" - 18"	1409, Class 600, Raised Face, ASME B16.5, Class 600, Raised Face						
20" - 24"	ASME B16.5, Class 600, Raised Face						
26" - 60"	ASME B16.47 A, Class 600, Raised Face						
7. Size Range (NPS)	1/2" - 60"						
8. Additional requirements	-						
9. Weight	-						
10. Dimension	-						

Commodity Code	J-600-EM		
Specs	E30		
1. Gasket type	Spiral-wound Gasket		
2. Material	Inconel 625 windings with flexible graphite filler		
3. Gasket standard	ASME B16.20		
4. Thickness	4,4 mm		
5. Centering and Inner rings	Centering ring in AISI 316 and inner ring in Inconel 625		
6. Flange Type	<table border="1"> <tr> <td>1/2" - 16"</td> <td>ASME B16.5, Class 600, Raised Face</td> </tr> </table>	1/2" - 16"	ASME B16.5, Class 600, Raised Face
1/2" - 16"	ASME B16.5, Class 600, Raised Face		
7. Size Range (NPS)	1/2" - 24"		
8. Additional requirements	-		
9. Weight	-		
10. Dimension	-		

B12.5.4 RING-JOINT GASKET

Commodity Code	J-1500-AN
Specs	G10
1. Gasket type	Oval Type R Ring
2. Material	Carbon Steel
3. Gasket standard	API 6A, ASME B16.20
4. Thickness	-
5. Hardness	maximum hardness 90 Brinell
6. Flange Type	Class 1500, Ring Type Joint
7. Size Range (NPS)	1/2" - 24"
8. Additional requirements	-
9. Weight	-
10. Dimension	-

Commodity Code	J-1500-AT
Specs	F6 G3 G16P G16
1. Gasket type	Oval Type R Ring
2. Material	SS AISI 316
3. Gasket standard	API 6A, ASME B16.20
4. Thickness	-
5. Hardness	maximum hardness 160 Brinell
6. Flange Type	Class 1500, Ring Type Joint
7. Size Range (NPS)	1/2" - 24"
8. Additional requirements	-
9. Weight	-
10. Dimension	-

Commodity Code	J-2500-AW
Specs	
1. Gasket type	Oval Type R Ring
2. Material	ASTM A522 Type I
3. Gasket standard	API 6A, ASME B16.20
4. Thickness	-
5. Hardness	maximum hardness 210 Brinell
6. Flange Type	Class 2500, Ring Type Joint
7. Size Range (NPS)	1" - 12"
8. Additional requirements	-
9. Weight	-
10. Dimension	-

Commodity Code	J-2500-BU
Specs	H12P H12 H16
1. Gasket type	IX Ring type
2. Material	Duplex Stainless Steel, ASTM A182 F51
3. Gasket standard	ISO 27509
4. Thickness	-
5. Hardness	-
6. Flange Type	Class 2500, Metallic Seal Joint
7. Size Range (NPS)	1" - 24"
8. Additional requirements	-
9. Weight	-
10. Dimension	-

Commodity Code	J-2500-BV
Specs	H3 H30
1. Gasket type	IX Ring type
2. Material	Inconel 625
3. Gasket standard	ISO 27509
4. Thickness	-
5. Hardness	-
6. Flange Type	Class 2500, Metallic Seal Joint
7. Size Range (NPS)	1" - 24"
8. Additional requirements	-
9. Weight	-
10. Dimension	-

Commodity Code	J-2500-BW
Specs	
1. Gasket type	IX Ring type
2. Material	ASTM A522 Type I
3. Gasket standard	ISO 27509
4. Thickness	-
5. Hardness	-
6. Flange Type	Class 2500, Metallic Seal Joint
7. Size Range (NPS)	14" - 16"
8. Additional requirements	-
9. Weight	-
10. Dimension	-

Commodity Code	J-300-AT
Specs	
1. Gasket type	Oval Type R Ring
2. Material	SS AISI 316
3. Gasket standard	API 6A, ASME B16.20
4. Thickness	-
5. Hardness	maximum hardness 160 Brinell
6. Flange Type	Class 300, Ring Type Joint
7. Size Range (NPS)	1/2" - 48"
8. Additional requirements	-
9. Weight	-
10. Dimension	-

Commodity Code	J-600-AT
Specs	
1. Gasket type	Oval Type R Ring
2. Material	SS AISI 316
3. Gasket standard	API 6A, ASME B16.20
4. Thickness	-
5. Hardness	maximum hardness 160 Brinell
6. Flange Type	Class 600, Ring Type Joint
7. Size Range (NPS)	-
8. Additional requirements	-
9. Weight	-
10. Dimension	-

Commodity Code	J-600-AV
Specs	
1. Gasket type	Oval Type R Ring
2. Material	Inconel 625
3. Gasket standard	API 6A, ASME B16.20
4. Thickness	-
5. Hardness	maximum hardness 230 Brinell
6. Flange Type	Class 600, Ring Type Joint
7. Size Range (NPS)	-
8. Additional requirements	-
9. Weight	-
10. Dimension	-

Commodity Code	J-900-AT
Specs	F6
1. Gasket type	Oval Type R Ring
2. Material	SS AISI 316
3. Gasket standard	API 6A, ASME B16.20
4. Thickness	-
5. Hardness	maximum hardness 160 Brinell
6. Flange Type	Class 900, Ring Type Joint
7. Size Range (NPS)	3" - 20"
8. Additional requirements	-
9. Weight	-
10. Dimension	-

B12.5.5 GROOVED METAL GASKET

Commodity Code	J-300-G1				
Specs					
1. Gasket type	Grooved metal Gasket				
2. Material	AISI 316 grooved core with Mica based covering layers (high temperature)				
3. Gasket standard	ASME B16.20				
4. Thickness	4,4 mm				
5. Centering and Inner rings	Centering ring in AISI 316				
6. Flange Type	<table border="1"> <tr> <td>2" - 24"</td> <td>1409, Class 300</td> </tr> <tr> <td>26" - 56"</td> <td>945, Class 300</td> </tr> </table>	2" - 24"	1409, Class 300	26" - 56"	945, Class 300
2" - 24"	1409, Class 300				
26" - 56"	945, Class 300				
7. Size Range (NPS)	2" - 56"				
8. Additional requirements	-				

6. STUD & NUTS

STUD BOLT WITH 2 HEAVY HEXAGONAL NUTS

Commodity Code	P-1500-08	
Specs	G3 G10 G16P	
1. Item	Stud Bolt with 2 Heavy Hexagonal Nuts	
2. Bolt material	ASTM A320 Gr L7, Zn-Ni coated	
3. Nuts material	Hex heavy ASTM A194 Gr 7L, Zn-Ni coated	
4. Bolt thread type	½" - 1"	ASME B1.1, UNC 2A
	1 ⅝" - 3 ½"	ASME B1.1, UN 2A - 8 thd/in
5. Nut thread type	½" - 1"	ASME B1.1, UNC 2B
	1 ⅝" - 3 ½"	ASME B1.1, UN 2B - 8 thd/in
6. Coating	Zn-Ni ASTM B 841, C1 1, B/E Type, Gr 5-8, heat treatment according ASTM B849/B850	
7. Size Range	½" - 3 ½"	
8. Additional requirements	-	
9. Weight	-	
10. Dimension	-	

Commodity Code	P-1500-09	
Specs	G16	
1. Item	Stud Bolt with 2 Heavy Hexagonal Nuts	
2. Bolt material	ASTM A320 Gr L43, Zn-Ni coated	
3. Nuts material	Hex heavy ASTM A194 Gr 7L, Zn-Ni coated	
4. Bolt thread type	¾" - 1"	ASME B1.1, UNC 2A
	1 ⅝" - 3 ½"	ASME B1.1, UN 2A - 8 thd/in
5. Nut thread type	¾" - 1"	ASME B1.1, UNC 2B
	1 ⅝" - 3 ½"	ASME B1.1, UN 2B - 8 thd/in
6. Coating	Zn-Ni ASTM B 841, C1 1, B/E Type, Gr 5-8, heat treatment according ASTM B849/B850	
7. Size Range	¾" - 3 ½"	
8. Additional requirements	-	
9. Weight	-	
10. Dimension	-	

Commodity Code	P-150-01	
Specs	B4	
1. Item	Stud Bolt with 2 Heavy Hexagonal Nuts	
2. Bolt material	ASTM A193 Gr B7	
3. Nuts material	HEX HEAVY ASTM A194 GR 2H	
4. Bolt thread type	½" - 1"	ASME B1.1, UNC 2A
	1 ⅝" - 3 ½"	ASME B1.1, UN 2A - 8 thd/in
5. Nut thread type	½" - 1"	ASME B1.1, UNC 2B
	1 ⅝" - 3 ½"	ASME B1.1, UN 2B - 8 thd/in
6. Coating	-	
7. Size Range	½" - 3 ½"	
8. Additional requirements	-	
9. Weight	-	
10. Dimension	-	

Commodity Code	P-150-07	
Specs	B6 B7 B9 B10 B11 B14 B16 B22 B23 B26 B27 B28 B30	
1. Item	Stud Bolt with 2 Heavy Hexagonal Nuts	
2. Bolt material	ASTM A193 Gr B7, Zn-Ni coated	
3. Nuts material	Hex heavy ASTM A194 Gr 2H, Zn-Ni coated	
4. Bolt thread type	½" - 1"	ASME B1.1, UNC 2A
	1 ⅝" - 3 ½"	ASME B1.1, UN 2A - 8 thd/in
5. Nut thread type	½" - 1"	ASME B1.1, UNC 2B
	1 ⅝" - 3 ½"	ASME B1.1, UN 2B - 8 thd/in
6. Coating	Zn-Ni ASTM B 841, C1 1, B/E Type, Gr 5-8, heat treatment according ASTM B849/B850	
7. Size Range	½" - 3 ½"	
8. Additional requirements	-	
9. Weight	-	
10. Dimension	-	

Commodity Code	P-150-08	
Specs	B3 B12	
1. Item	Stud Bolt with 2 Heavy Hexagonal Nuts	
2. Bolt material	ASTM A320 Gr L7, Zn-Ni coated	
3. Nuts material	Hex heavy ASTM A194 Gr 7L, Zn-Ni coated	
4. Bolt thread type	½" - 1"	ASME B1.1, UNC 2A
	1 ⅝" - 3 ½"	ASME B1.1, UN 2A - 8 thd/in
5. Nut thread type	½" - 1"	ASME B1.1, UNC 2B
	1 ⅝" - 3 ½"	ASME B1.1, UN 2B - 8 thd/in
6. Coating	Zn-Ni ASTM B 841, C1 1, B/E Type, Gr 5-8, heat treatment according ASTM B849/B850	
7. Size Range	½" - 3 ½"	
8. Additional requirements	-	
9. Weight	-	
10. Dimension	-	

Commodity Code	P-2500-11	
Specs	H3 H12P H12 H16 H30	
1. Item	Stud Bolt with 2 Heavy Hexagonal Nuts	
2. Bolt material	ASTM A320 Gr L7M, Zn-Ni coated	
3. Nuts material	Hex heavy ASTM A194 Gr 7ML, Zn-Ni coated	
4. Bolt thread type	½" - 1"	ASME B1.1, UNC 2A
	1 ⅝" - 3 ½"	ASME B1.1, UN 2A - 8 thd/in
5. Nut thread type	½" - 1"	ASME B1.1, UNC 2B
	1 ⅝" - 3 ½"	ASME B1.1, UN 2B - 8 thd/in
6. Coating	Zn-Ni ASTM B 841, C1 1, B/E Type, Gr 5-8, heat treatment according ASTM B849/B850	
7. Size Range	½" - 3 ½"	
8. Additional requirements	-	
9. Weight	-	
10. Dimension	-	

Commodity Code	P-2500-13	
Specs	H3 H12P H12	
1. Item	Stud Bolt with 2 Heavy Hexagonal Nuts	
2. Bolt material	718 as per API6ACRA UNS N07718	
3. Nuts material	718 as per API6ACRA UNS N07718	
4. Bolt thread type	½" - 1"	ASME B1.1, UNC 2A
	1 ⅝" - 3 ½"	ASME B1.1, UN 2A - 8 thd/in
5. Nut thread type	½" - 1"	ASME B1.1, UNC 2B
	1 ⅝" - 3 ½"	ASME B1.1, UN 2B - 8 thd/in
6. Coating	-	
7. Size Range	½" - 3 ½"	
8. Additional requirements	-	
9. Weight	-	
10. Dimension	-	

Commodity Code	P-300-07	
Specs	C6 C8 C10 C11 C16 C23 C30	
1. Item	Stud Bolt with 2 Heavy Hexagonal Nuts	
2. Bolt material	ASTM A193 Gr B7, Zn-Ni coated	
3. Nuts material	Hex heavy ASTM A194 Gr 2H, Zn-Ni coated	
4. Bolt thread type	½" - 1"	ASME B1.1, UNC 2A
	1 ⅝" - 3 ½"	ASME B1.1, UN 2A - 8 thd/in
5. Nut thread type	½" - 1"	ASME B1.1, UNC 2B
	1 ⅝" - 3 ½"	ASME B1.1, UN 2B - 8 thd/in
6. Coating	Zn-Ni ASTM B 841, C1 1, B/E Type, Gr 5-8, heat treatment according ASTM B849/B850	
7. Size Range	½" - 3 ½"	
8. Additional requirements	-	
9. Weight	-	
10. Dimension	-	

Commodity Code	P-300-08	
Specs	C3	
1. Item	Stud Bolt with 2 Heavy Hexagonal Nuts	
2. Bolt material	ASTM A320 Gr L7, Zn-Ni coated	
3. Nuts material	Hex heavy ASTM A194 Gr 7L, Zn-Ni coated	
4. Bolt thread type	½" - 1"	ASME B1.1, UNC 2A
	1 ⅝" - 3 ½"	ASME B1.1, UN 2A - 8 thd/in
5. Nut thread type	½" - 1"	ASME B1.1, UNC 2B
	1 ⅝" - 3 ½"	ASME B1.1, UN 2B - 8 thd/in
6. Coating	Zn-Ni ASTM B 841, C1 1, B/E Type, Gr 5-8, heat treatment according ASTM B849/B850	
7. Size Range	½" - 3 ½"	
8. Additional requirements	-	
9. Weight	-	
10. Dimension	-	

Commodity Code	P-600-02	
Specs	E19	
1. Item	Stud Bolt with 2 Heavy Hexagonal Nuts	
2. Bolt material	ASTM A320 GR L7	
3. Nuts material	HEX HEAVY ASTM A194 GR 7L	
4. Bolt thread type	½" - 1"	ASME B1.1, UNC 2A
	1 ⅝" - 3 ½"	ASME B1.1, UN 2A - 8 thd/in
5. Nut thread type	½" - 1"	ASME B1.1, UNC 2B
	1 ⅝" - 3 ½"	ASME B1.1, UN 2B - 8 thd/in
6. Coating	-	
7. Size Range	½" - 3 ½"	
8. Additional requirements	-	
9. Weight	-	
10. Dimension	-	

Commodity Code	P-600-07	
Specs	E8	
1. Item	Stud Bolt with 2 Heavy Hexagonal Nuts	
2. Bolt material	ASTM A193 Gr B7, Zn-Ni coated	
3. Nuts material	Hex heavy ASTM A194 Gr 2H, Zn-Ni coated	
4. Bolt thread type	½" - 1"	ASME B1.1, UNC 2A
	1 ⅝" - 3 ½"	ASME B1.1, UN 2A - 8 thd/in
5. Nut thread type	½" - 1"	ASME B1.1, UNC 2B
	1 ⅝" - 3 ½"	ASME B1.1, UN 2B - 8 thd/in
6. Coating	Zn-Ni ASTM B 841, C1 1, B/E Type, Gr 5-8, heat treatment according ASTM B849/B850	
7. Size Range	½" - 3 ½"	
8. Additional requirements	-	
9. Weight	-	
10. Dimension	-	

Commodity Code	P-600-08	
Specs	E3 E6 E16 E30 E34	
1. Item	Stud Bolt with 2 Heavy Hexagonal Nuts	
2. Bolt material	ASTM A320 Gr L7, Zn-Ni coated	
3. Nuts material	Hex heavy ASTM A194 Gr 7L, Zn-Ni coated	
4. Bolt thread type	½" - 1"	ASME B1.1, UNC 2A
	1 ⅝" - 3 ½"	ASME B1.1, UN 2A - 8 thd/in
5. Nut thread type	½" - 1"	ASME B1.1, UNC 2B
	1 ⅝" - 3 ½"	ASME B1.1, UN 2B - 8 thd/in
6. Coating	Zn-Ni ASTM B 841, C1 1, B/E Type, Gr 5-8, heat treatment according ASTM B849/B850	
7. Size Range	½" - 3 ½"	
8. Additional requirements	-	
9. Weight	-	
10. Dimension	-	

Commodity Code	P-900-02	
Specs	F6	
1. Item	Stud Bolt with 2 Heavy Hexagonal Nuts	
2. Bolt material	ASTM A320 GR L7	
3. Nuts material	HEX HEAVY ASTM A194 GR 7L	
4. Bolt thread type	½" - 1"	ASME B1.1, UNC 2A
	1 ⅝" - 3 ½"	ASME B1.1, UN 2A - 8 thd/in
5. Nut thread type	½" - 1"	ASME B1.1, UNC 2B
	1 ⅝" - 3 ½"	ASME B1.1, UN 2B - 8 thd/in
6. Coating	-	
7. Size Range	½" - 3 ½"	
8. Additional requirements	-	
9. Weight	-	
10. Dimension	-	



7. BOLT

2 X HEXAGONAL BOLT

Commodity Code	H-1500-01
Specs	
1. Item	2 x Hex Bolt
2. Bolt material	A193 B7
3. Nuts material	-
4. Bolt thread type	B1.1
5. Nut thread type	B1.1
6. Coating	Zn-Ni
7. Size Range	-
8. Additional requirements	-
9. weight	-
10. Dimension	-

Commodity Code	H-1500-02
Specs	
1. Item	2 x Hex Bolt
2. Bolt material	A320 L7
3. Nuts material	-
4. Bolt thread type	B1.1
5. Nut thread type	B1.1
6. Coating	Zn-Ni
7. Size Range	-
8. Additional requirements	-
9. weight	-
10. Dimension	-

Commodity Code	H-150-01
Specs	B4 B6 B7 B9 B10 B11 B14 B16 B22 B23 B26 B28 B30
1. Item	2 x Hex Bolt
2. Bolt material	A193 B7
3. Nuts material	-
4. Bolt thread type	B1.1
5. Nut thread type	B1.1
6. Coating	Zn-Ni
7. Size Range	½" - 1 ½"
8. Additional requirements	-
9. weight	-
10. Dimension	-

Commodity Code	H-150-02
Specs	B3 B12
1. Item	2 x Hex Bolt
2. Bolt material	A320 L7
3. Nuts material	-
4. Bolt thread type	B1.1
5. Nut thread type	B1.1
6. Coating	Zn-Ni
7. Size Range	-
8. Additional requirements	-
9. weight	-
10. Dimension	-

Commodity Code	H-2500-01
Specs	
1. Item	2 x Hex Bolt
2. Bolt material	A193 B7
3. Nuts material	-
4. Bolt thread type	B1.1
5. Nut thread type	B1.1
6. Coating	Zn-Ni
7. Size Range	-
8. Additional requirements	-
9. weight	-
10. Dimension	-

Commodity Code	H-2500-02
Specs	
1. Item	2 x Hex Bolt
2. Bolt material	A320 L7
3. Nuts material	-
4. Bolt thread type	B1.1
5. Nut thread type	B1.1
6. Coating	Zn-Ni
7. Size Range	-
8. Additional requirements	-
9. weight	-
10. Dimension	-

Commodity Code	H-300-01
Specs	C6 C8 C10 C11 C16 C23 C30
1. Item	2 x Hex Bolt
2. Bolt material	A193 B7
3. Nuts material	-
4. Bolt thread type	B1.1
5. Nut thread type	B1.1
6. Coating	Zn-Ni
7. Size Range	½" - 1 ½"
8. Additional requirements	-
9. weight	-
10. Dimension	-

Commodity Code	H-300-02
Specs	C3
1. Item	2 x Hex Bolt
2. Bolt material	A320 L7
3. Nuts material	-
4. Bolt thread type	B1.1
5. Nut thread type	B1.1
6. Coating	Zn-Ni
7. Size Range	½" - 1 ½"
8. Additional requirements	-
9. weight	-
10. Dimension	-

Commodity Code	H-600-01
Specs	
1. Item	2 x Hex Bolt
2. Bolt material	A193 B7
3. Nuts material	-
4. Bolt thread type	B1.1
5. Nut thread type	B1.1
6. Coating	Zn-Ni
7. Size Range	-
8. Additional requirements	-
9. weight	-
10. Dimension	-

Commodity Code	H-600-02
Specs	
1. Item	2 x Hex Bolt
2. Bolt material	A320 L7
3. Nuts material	-
4. Bolt thread type	B1.1
5. Nut thread type	B1.1
6. Coating	Zn-Ni
7. Size Range	-
8. Additional requirements	-
9. weight	-
10. Dimension	-

Commodity Code	H-900-01
Specs	
1. Item	2 x Hex Bolt
2. Bolt material	A193 B7
3. Nuts material	-
4. Bolt thread type	B1.1
5. Nut thread type	B1.1
6. Coating	Zn-Ni
7. Size Range	-
8. Additional requirements	-
9. weight	-
10. Dimension	-

Commodity Code	H-900-02
Specs	
1. Item	2 x Hex Bolt
2. Bolt material	A320 L7
3. Nuts material	-
4. Bolt thread type	B1.1
5. Nut thread type	B1.1
6. Coating	Zn-Ni
7. Size Range	-
8. Additional requirements	-
9. weight	-
10. Dimension	-



# **ANNEX C**

## **TYPICAL ARRANGEMENT FOR DRAIN&VENT AND INSTRUMENTS (Mandatory)**

## INDEX

<b>C.1.SCOPE .....</b>	<b>3</b>
<b>C.2.TYPICAL ARRANGEMENT FOR TEMPERATURE WELLS .....</b>	<b>3</b>
<b>C.3.TYPICAL ARRANGEMENT FOR DRAINS AND VENTS .....</b>	<b>5</b>
<b>C.4.TYPICAL ARRANGEMENT FOR PRESSURE INSTRUMENTS .....</b>	<b>9</b>
<b>C.5.TYPICAL ARRANGEMENT FOR ORIFICE FLANGE.....</b>	<b>11</b>
<b>C.6.TYPICAL ARRANGEMENT FOR FOR TUBING (SPEC T3) .....</b>	<b>12</b>

### C.1.SCOPE

This document stabilishes typical piping arrangements for installation of temperature wells, pressure instruments, orifice flanges, drains and vents. It's applicable for the Exploration and Production (E&P) business area, onshore and offshore, especially in oil and gas production and their process facilities.

### C.2.TYPICAL ARRANGEMENT FOR TEMPERATURE WELLS

C.2.1. Thermowell assembly in change direction fitting could be done when not prohibited by specific requirement defined by Instrumentation, Process or TBM team.

Table C.1- Typical arrangement for Thermowell (notes 3 and 4)

SPEC	Pipe Diameter	Type of Instalation					
		Curved			Vertical/Horizontal		
		¾" NPT Threaded	1 ½" Flanged	2" Flanged	¾" NPT Threaded	1 ½" Flanged	2" Flanged
CLASS 125	¾" to 1 ½"	Type 1A			Type 1C		
	2"	Type 1B					
	3" to 4"	Type 1E			Type 1D		
CLASS 150 up to 600(note 1 and 2)	¾" to 1 ½"		Type 2A			Type 2C	
	2"		Type 2B				
	2 ½ and 3"		Type 2E				
	4" and above					Type 2D	
CLASS 900 up to 10000	¾" to 1 ½"			Type 2A			Type 2C
	2"			Type 2B			
	2 ½ and 3"			Type 2E			Type 2D
	4" and above						
Non-metallic piping	All		Not Applicable				

Notes:

- 1 – If pipe thickness for NPS 1 ½ is SCH XXS, it shall be used NPS 2 flanged connection.
- 2 – For piping specifications without NPS 1 ½, it shall be used NPS 2 flanged connection.
- 3 – The requirements of I-ET-3010.00-1200-800-P4X-013 - GENERAL CRITERIA FOR INSTRUMENTATION PROJECTS shall be also attended.
- 4 – The flange diameters shown on Table C.1 are typical diameters, but it must be confirmed in detailed design phase with instrumentation team.

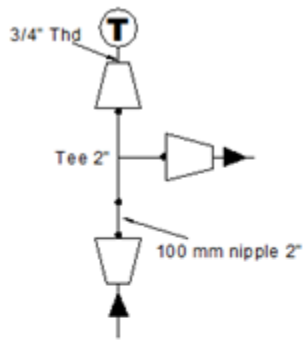

1A - Preferred arrangement  
 NPS 3/4 up to 1 1/2

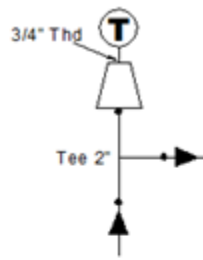

1B - Preferred arrangement  
 NPS 2

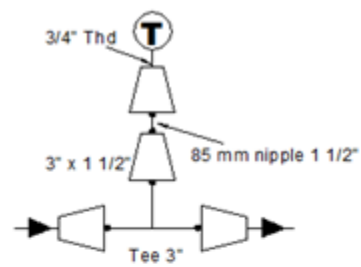

1C - Use only when 1A and  
 1B are not possible

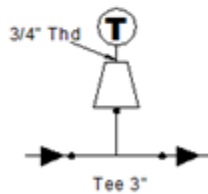

1D - Preferred arrangement  
 NPS 3 and 4

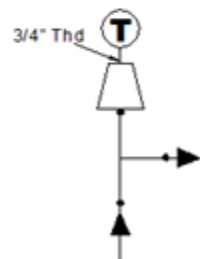

1E - Use only when 1D is  
 not possible

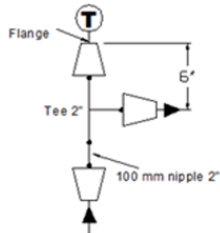

2A  
 NPS 3/4 to 1 1/2  
 (Only in vertical position)

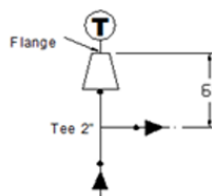

2B  
 NPS 2  
 (Only in vertical position)

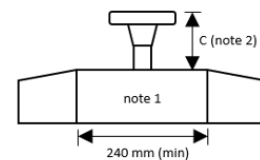

2C  
 note 1: run pipe <= NPS 2 1/2" expansion to NPS 3  
 run pipe = NPS 3 expansion to NPS 4  
 note 2: accord. to table below

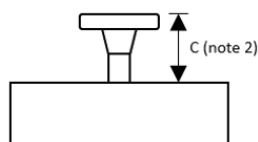

2D  
 NPS >= 4  
 note 2: accord. to table below

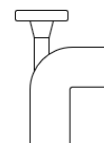

2E  
 (Only in vertical position)

	Pressure Class			
	150, 300 and 600	900 and 1500	2500	10000
C (mm)	150	165	190	150

### C.3.TYPICAL ARRANGEMENT FOR DRAINS AND VENTS

C.3.1. Drain and vent size and pipe details shall be according to Table C.2.

C.3.2. For tubing, drain and vent size shall be 3/4" for piperun  $\geq$  3/4" and it will be the same size of piperun for piping  $<$  3/4".

Table C.2

Line size	Minimum Drain size (note 1 and 2)	Vent size (note 1)	Valve End (note 1 and 2)	
			CL 150 to CL 1500	CL 2500 and 10000 PSI
3/4 to 4	3/4	3/4	nipple with threaded cap (Figure C.1 and C.5)	Flanged (Figure C.2)
6 to 10	1			
12 and above	1 1/2			

**Note 1:** For Group 5 specs, organic coated specs (Group 11 and 14), class 2500 and 10000psi specs: minimum pipe size for drains and vents shall be NPS 1. Vents maximum pipe size is also limited to NPS 1. Valves shall be flanged type selected according to the respectively piping spec (piping detail acc. Figure C.2).

**Note 2:** For CuNi specs (group 7) and galvanized carbon steel (group 8) specs, valves drain and vents shall be flanged type selected according to the respectively piping spec (piping detail acc. Figure C.2).

C.3.3. Except for tubing, valves of drain and vent used only for hydrostatic pressure test shall be removed and replaced by blind flanges after the test (Figure C.3). Valves codes for hydrostatic test are listed on below:

- Class 150# - VES-150-1-C100
- Class 300# - VES-300-1-C100
- Class 600# - VES-600-1-C100
- Class 900# - VES-900-1-C100
- Class 1500# - VES-1500-1-C100
- Class 2500# - VES-2500-1-C100

C.3.4. Threaded cap shall be tied to pipe to avoid losing the cap. It may be provided with chain or wire rope, handle, and swivel clamp. As an example, see Figure C.5. The material selection shall be taking account the environment and dissimilar materials in contact. For class 10K the maximum diameter for NPT threads is NPS 1/2 according to API 6A.



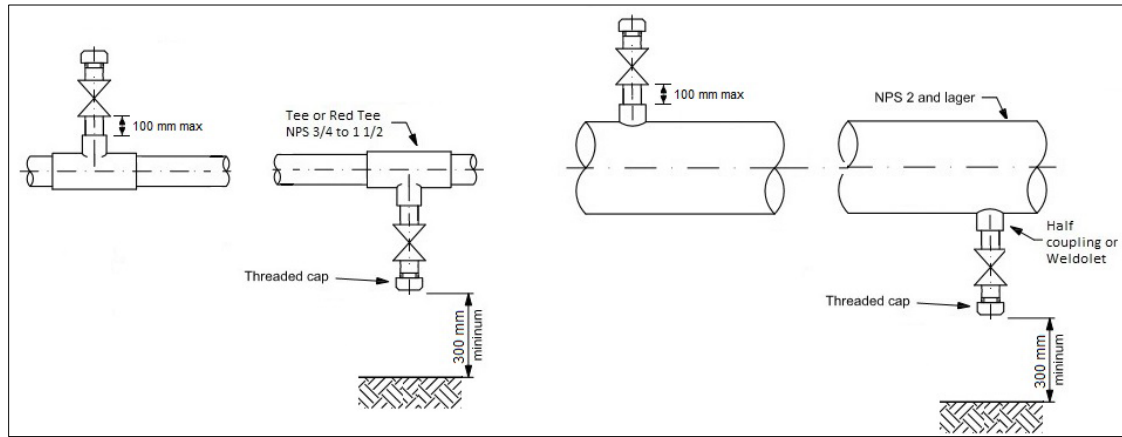

Figure C.1A - Drain&Vent single valve with threaded cap end for piping specs class 150, 300 and 600

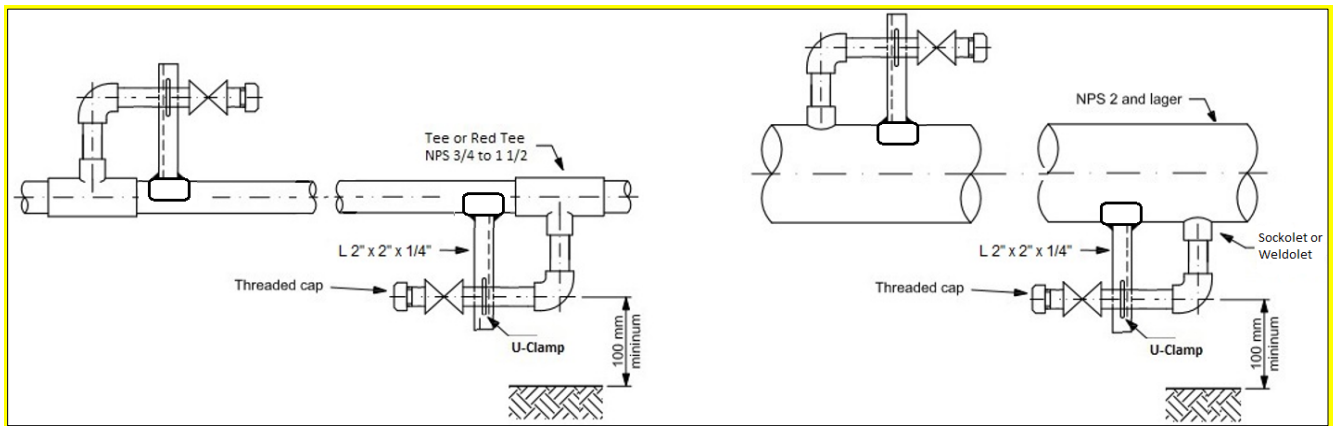

Figure C.1B - Drain&Vent single valve with threaded cap end for piping spec class 900 and 1500 (note 3).

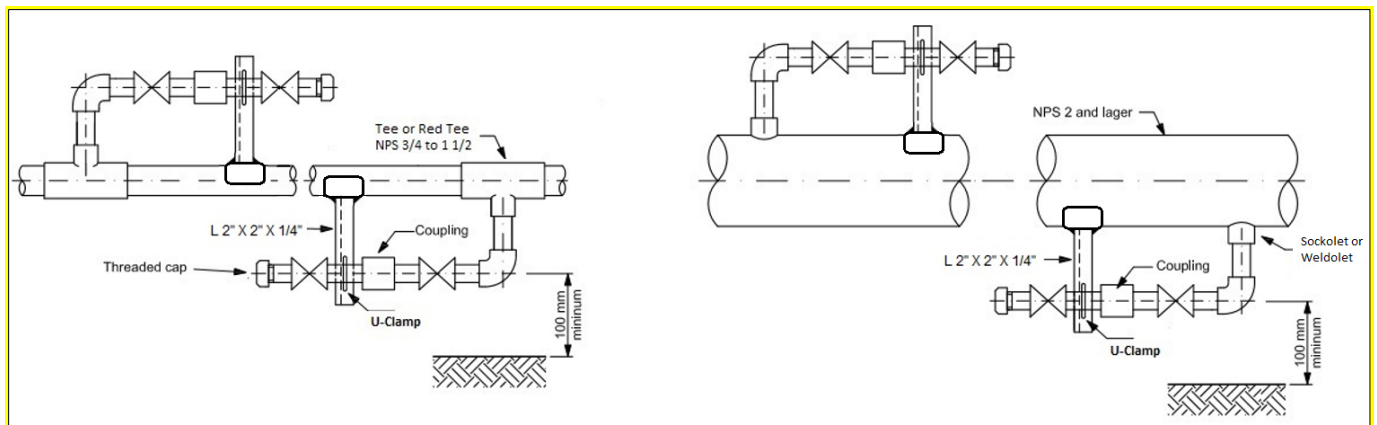

Figure C.1C - Drain&Vent two valves with threaded cap end

Notes:

- 1 – Valve type shall be selected in piping specification.
- 2 – See Figure C.3 for U-clamp details.
- 3 – Figure C.1B may be used as alternative to Figure C.1A
- 4 – Shall be followed the requirements of I-ET-3000.00-1200-200-P4X-004 - Requirements for Piping Support - for piping subject to vibration and other cases mentioned there.

**Figure C.1 – Drain&Vent pipe detail for class 150 to 1500**

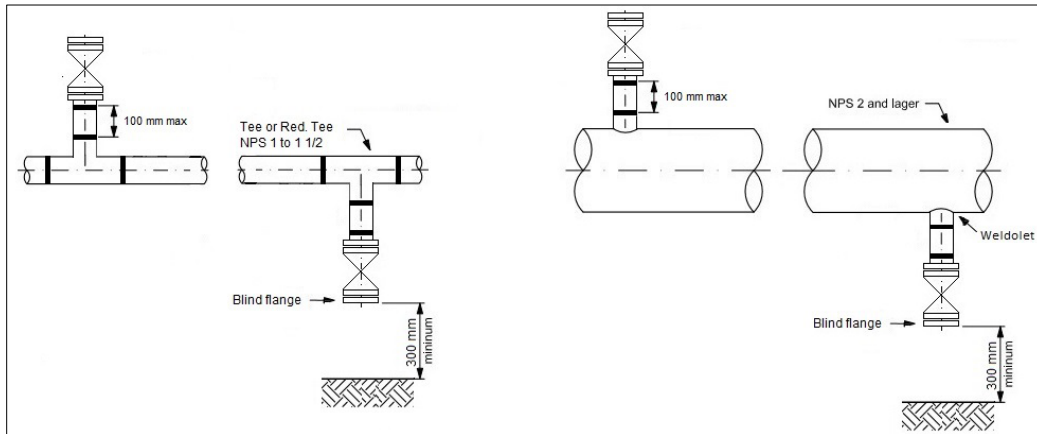

Figure C.2A - Drain & Vent single flanged valve with blind flange end for piping specs class 150, 300 and 600

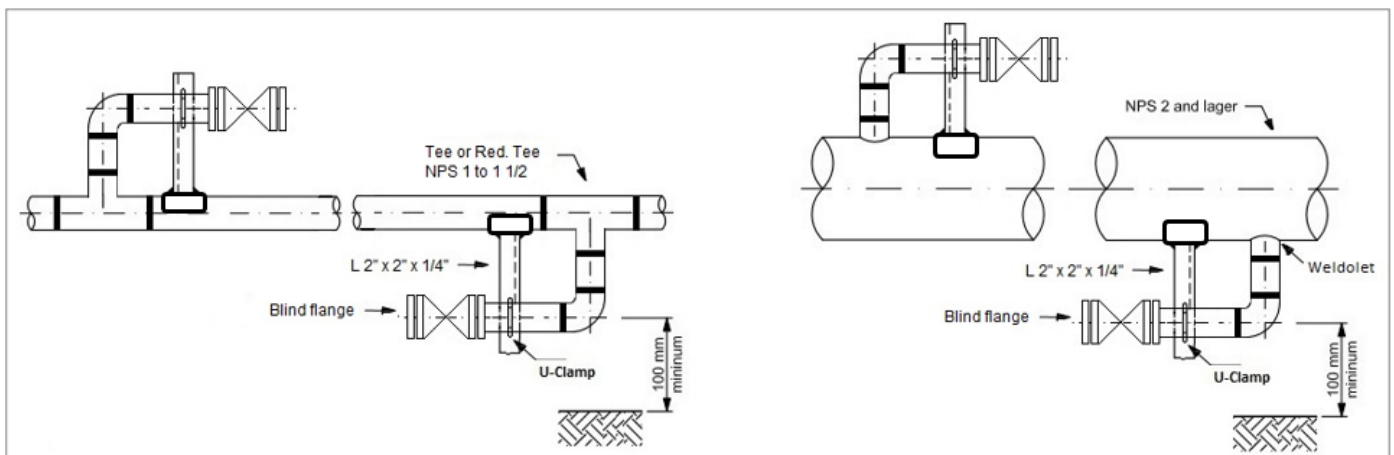

Figure C.2B - Drain & Vent single flanged valve with blind flange end for piping specs class 900 and higher. (note 3)

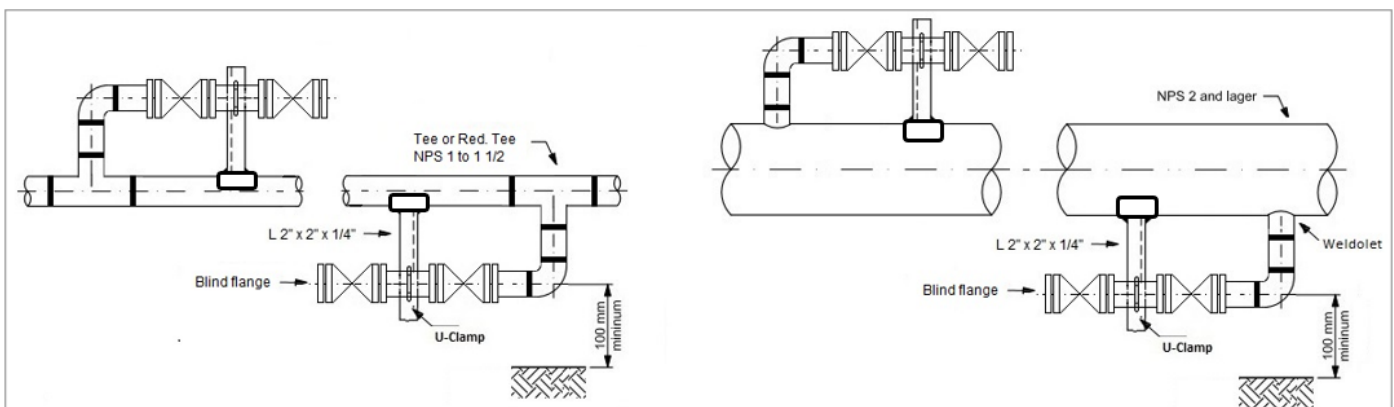
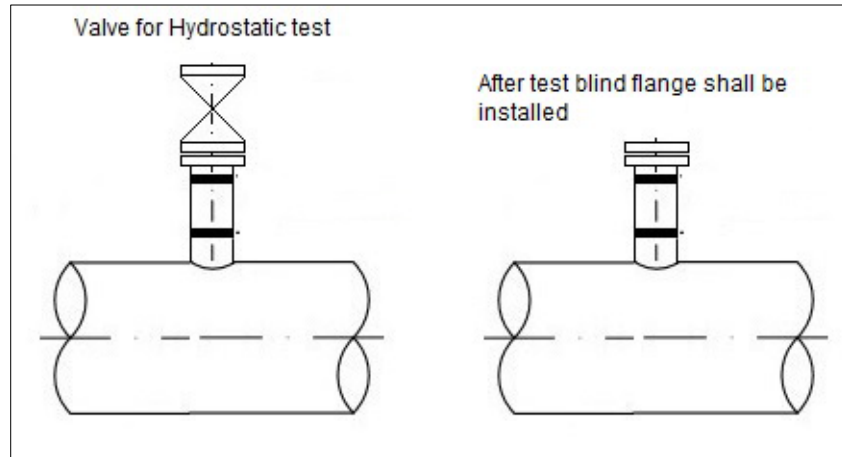

Figure C.2B - Drain & Vent two flanged valves with blind flange end

Notes:

- 1 – Valve type shall be selected in piping specification.
- 2 – See Figure C.4 for U-clamp details.
- 3 – Figure C.2B may be used as alternative to Figure C.2A
- 4 - Shall be followed the requirements of I-ET-3000.00-1200-200-P4X-004 - Requirements for Piping Support - for piping subject to vibration and other cases mentioned there.

**Figure C.2 – Drain & Vent pipe detail for class 2500 and 10000 psi**



**Figure C.3 – Drain&Vent for Hydrostatic Test**

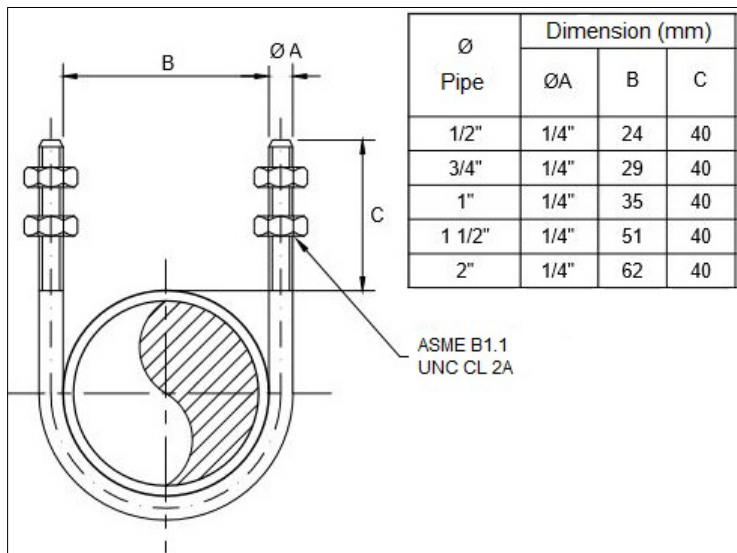

Notes:

1 – Material carbon steel coated with epoxy plastic powder.

**Figure C.4 – U clamp details**

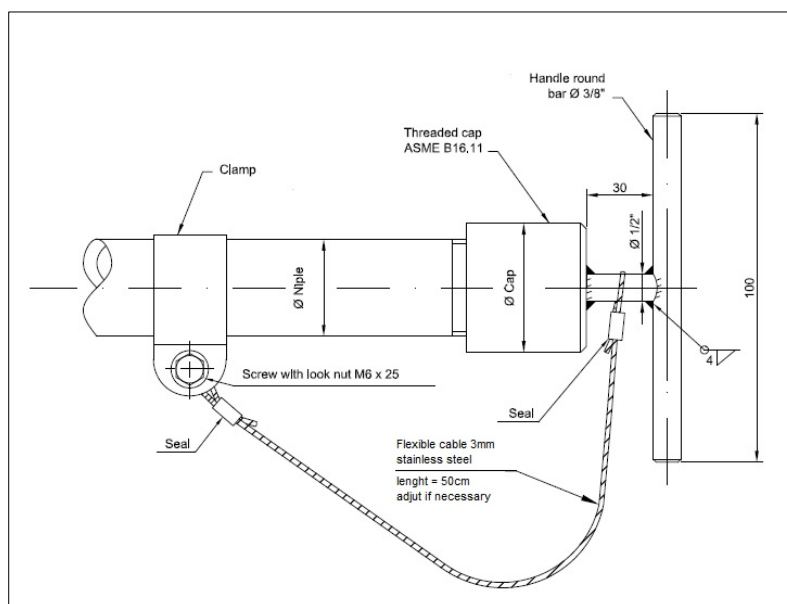

**Figure C.5 – Threaded cap with cable (example)**

### C.4.TYPICAL ARRANGEMENT FOR PRESSURE INSTRUMENTS

C.4.1. Piping connection for pressure and differential pressure shall be according to Instrumentation but connections for and based on pressure and differential pressure are flanged with minimum size according to figures C.6, C.7 and C.8. When measurement utilizes chemical seal (diaphragm seal), either remote or integral, connection size shall follow DR-ENGP-M-I-1.5, being 1 1/2" the minimum size. Specs with internal organic coating the minimum diameter is 2" for instruments.

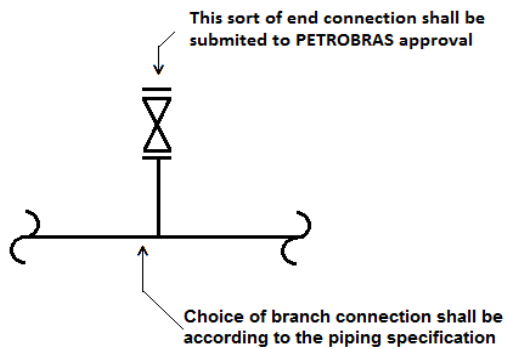

Figure C.6 – Typical instrumentation connection with piping valve included

PRESSURE AND DIFFERENTIAL PRESSURE FOR TRANSMITTERS AND GAUGES, ALL WITHOUT DIAPHRAGM SEAL.

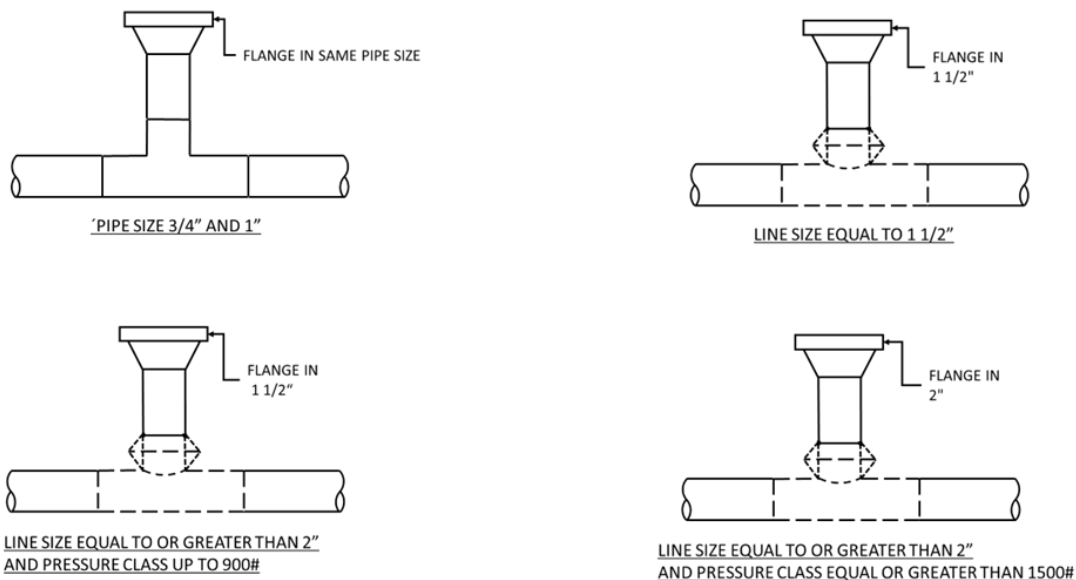
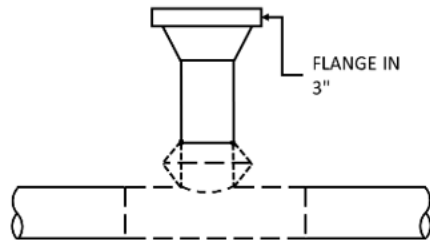
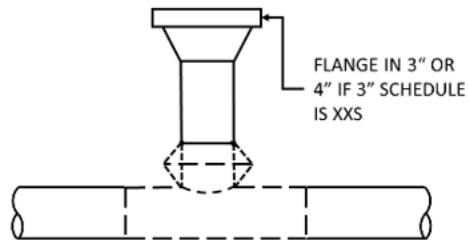

Figure C.7 – Details when diaphragm seal is not necessary (piping valve to be included acc to figure C.6)

- PRESSURE UP TO 3 BARG FOR TRANSMITTERS OR GAUGES
- DIFFERENTIAL PRESSURE FOR TRANSMITTERS OR GAUGES



LINE SIZE EQUAL TO 3" OR 3 1/2" AND 3" SCHEDULE IS NOT XXS



LINE SIZE EQUAL TO OR GREATER THAN 4"

Figure C.8 – Details pressure up to 3 barg or differential pressure for transmitter and gauges  
 (piping valve to be included acc to figure C.6)



### C.5.TYPICAL ARRANGEMENT FOR ORIFICE FLANGE

C.5.1. Orifice Flanges shall be according to ASME B16.36.

C.5.2. All Valves used in orifice flanges shall be NPS ½, except for specs listed in Table C.4.

C.5.3. For organic coated specs (Group 11 and 14) and FRP specs (B22, B23, B24, B26, and B27) use of orifice flanges is not permitted. In these lines, the flow tapes shall be installed with Stainless Steel AISI 316 spacer rings.

The scope of piping discipline includes all components up to the valve (

C.5.4. Figure C.).

C.5.5. Flange tap connection shall be welded. Threaded tap connection requires PETROBRAS approval.

Valve NPS	Spec
¾	B5 C5 E5 F5 G5 B17
1	B11 C11 E11 F11 G11 H11 B14 C14 E14 F14 G14 H14 E17 B22 B23 B24 B26 B27 H3 H6 H10 H10P H11 H30 H30P J5 J12 J31 J31PJ40
2	H5

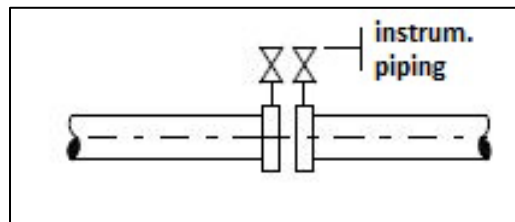

Table C.3- Connection diameter for orifice flanges

Figure C.9 – Scope definition

## C.6.TYPICAL ARRANGEMENT FOR FOR TUBING

C.6.1. Choice of branch shall be according to spec branch connections table.

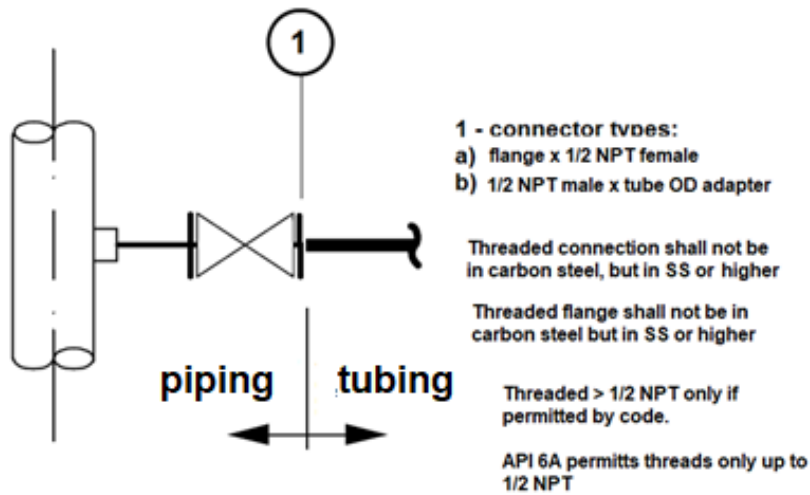

Figure C.11 – Instalation detail for high pressure

# **ANNEX E**

## **FLANGE ISOLATION KITS**

### **(Mandatory)**

## INDEX

<b>E.1. SCOPE .....</b>	<b>3</b>
<b>E.2. GENERAL DESCRIPTION .....</b>	<b>3</b>
<b>E.3. RECOMMENDED USE.....</b>	<b>3</b>
<b>E.4. ASSEMBLY .....</b>	<b>4</b>
<b>E.5. REQUIREMENTS .....</b>	<b>5</b>
<b>E.6. DESCRIPTION FOR COMMON TYPES OF ISOLATION KITS.....</b>	<b>5</b>
<b>E.7. MARKING.....</b>	<b>6</b>

## E.1. SCOPE

This document defines minimum technical requirements and conditions for purchasing flange electric isolation kits for Exploration and Production (E&P) business area, onshore and offshore, especially in oil and gas production and their process facilities.

The flange isolation kit contains gasket, bolt sleeves and washers.

## E.2. GENERAL DESCRIPTION

The flange kit isolations shall be manufactured from isolating material having low water absorption, high compressive strength and high dielectric strength.

Materials shall be applied taking account the operating conditions as temperature, pressure and fluid.

The flange isolation kit contains the following items:

Table E.1 – Isolation Kit items

Isolation Gasket	1 pc
Isolation Sleeve	1 pc per flange bolt
Isolation Washers	2 pcs per flange bolt
Metallic Washers	2 pcs per flange bolt

## E.3. RECOMMENDED USE

The use of flange isolation kit is recommended whenever two metals come into in an electrolyte with different electrode potentials.

Table E.2 give cases where flange isolation kit shall be applied.

Flange isolation kit is not required for instruments connection.

The Contractor is responsible for indicating and applying the isolation kit wherever it is necessary.



Table E.2 – Flange Isolation kit recommendation

Service code	Service description	Pipe Specs	Material 1	Material 2										
				CuNi 90/10	Bronze	Carbon Steel	Stainless Steel	Duplex	Super Duplex	3 1/2 Ni	9 Ni	Inconel	Carbon Steel Inconel clad	
FW	Fire Water (Aerated Seawater)	B7; B7R, B7H, S7	CuNi 90/10			Y					Y	Y		
HWU	Utility Heating Water	B4; F10	Carbon Steel	Y	Y		Y	Y	Y				Y	Y
IW	De-Aerated Seawater Injection	B10; C10; E10; F10; G10	Carbon Steel	Y	Y		Y	Y	Y				Y	Y
IW	De-Aerated Seawater Injection	C30; H30	Carbon Steel Inconel clad			Y					Y	Y		
PCW	Produced Water	B12; C12	SuperDuplex			Y					Y	Y		
SW	Seawater	B7R	CuNi			Y					Y	Y		

### E.4. ASSEMBLY

In order to avoid damage during installation and tightening, shall be followed the manufacturer installation guide.

Before installation, the isolation kit shall be checked and their surfaces must be free from imperfection as cracks and grooves.

Special attention shall be given to the correct position of metallic washers as demonstrated in Figure E.1. Due to washers and gasket thickness, it might be necessary bolts longer than the ones from the spec.

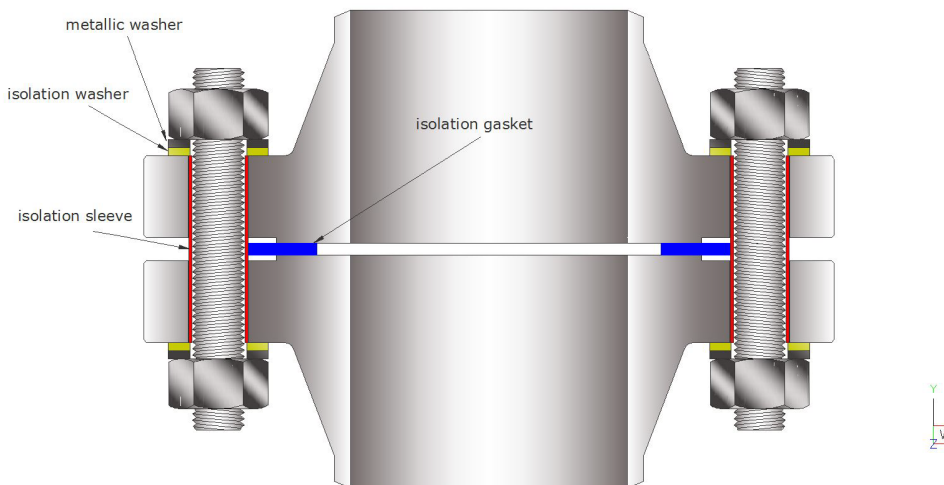

Figure E.1 – Example of RF flange kit isolation assembly.

## E.5. REQUIREMENTS

The manufacturer shall present third party certificates issued by certified laboratories meeting the standards and reference values listed below:

Table E.2 – Minimum Requirements for isolation Kits

Property	Standard	Value
Dielectric Strength	ASTM D149 (short time)	500 Volts/mil
Insulation Resistance	ASTM D257	40000 Megohms
Compressive Strength	ASTM D695	25000 psi
Water absorption	ASTM D229	1.6% (maximum)

## E.6. DESCRIPTION FOR COMMON TYPES OF ISOLATION KITS

Table E.3 contains examples for common specifications of isolation kits. The requirements listed in item E.5 must be added on the purchase order.

Table E.3 – Examples for Isolation Kit specification (note 1 and note 2 )

CLASS	TAG	Flange	Temperature Limits	Description
150 300	J-150-DY J-150-FY J-300-FY	150# FF 150# RF 300# RF	75°C	Phenolic gasket faced on both sides with Nitrile rubber; thickness 3,2 mm. G-10 isolating sleeves; two G-10 isolation washer and two hardened carbon steel washer Zn-Ni coated per bolt.
150 300	J-150-DA J-150-FA J-300-FA	150# FF 150# RF 300# RF	75°C	Isolation aramid fiber with Nitrile rubber gasket; thickness 3,2 mm. G-10 isolating sleeves; two G-10 isolation washer and two hardened carbon steel washer Zn-Ni coated per bolt.
150 300 600 900 1500 2500	J-150-FZ J-300-FZ J-600-FZ J-900-HZ J-1500-HZ J-2500-HZ	150# RF 300# RF 600# RF 900# RTJ 1500# RTJ 2500# RTJ	150°C	Metallic gasket, core in stainless steel 316 faced on both sides with insulation composite G-10, PTFE sealing ring. G-10 isolating sleeves; two G-10 isolation washer and two hardened carbon steel washer Zn-Ni coated per bolt.
150 300 600 900 1500 2500	J-150-FX J-300-FX J-600-FX J-900-HX J-1500-HX J-2500-HX	150# RF 300# RF 600# RF 900# RTJ 1500# RTJ 2500# RTJ	150°C	Metallic gasket, grooved core in stainless steel 316 faced on both sides with PTFE. G-10 isolating sleeves; two G-10 isolation washer and two hardened carbon steel washer Zn-Ni coated per bolt.

Note 1 – Alternative washer and sleeve material that may be applied in place of G10: Mylar and G11.

Note 2 - Other types of isolation kits are permitted. Table E.4 gives the minimum specifications to orientate purchase orders.

Table E.4 – Form example with general specification for other types of isolation kits

General description		Flange electric isolation set: Isolation Gasket            1 pc Isolation Sleeve            1 pc per flange bolt Isolation Washers           2 pcs per flange bolt Metallic Washers            2 pcs per flange bolt
Flange standard		
Flange facing and class		
Operating condition	Temperature (°C)	
	Pressure (bar)	
	Fluid	
Additional requirements		See Annex E from DR-ENGP-I-1.1
Certificates		See Annex E from DR-ENGP-I-1.1
The manufacturer shall present installation guide, including torque values.		

## E.7. MARKING

The following information shall be clearly stated on label attached to external surface of each isolation joint:

- Manufacturer's name or trademark;
- Nominal pipe size;
- Pressure class or Maximum operating pressure;
- Maximum operating temperature;
- Serial number.

# **ANNEX H**

## **REQUIREMENTS FOR FRP PIPES AND FITTINGS**

### **(MANDATORY)**

## INDEX

<b>REQUIREMENTS FOR FRP PIPES AND FITTINGS .....</b>	<b>1</b>
<b>(MANDATORY).....</b>	<b>1</b>
<b>H.1.SCOPE .....</b>	<b>3</b>
<b>H.2.REFERENCES .....</b>	<b>3</b>
<b>H.3.SYMBOLS AND ABBREVIATED TERMS .....</b>	<b>3</b>
<b>H.4.FABRICATION PROCESS.....</b>	<b>3</b>
H.4.1. CHEMICAL BARRIER.....	3
H.4.2. STRUCTURAL LAYER .....	3
H.4.3. EXTERNAL LINER.....	3
H.4.4. ADDITIVES .....	4
<b>H.5.MINIMUM STRUCTURAL THICKNESS.....</b>	<b>4</b>
<b>H.6.MATERIALS SELECTION .....</b>	<b>4</b>
<b>H.7.FIRE PERFORMANCE.....</b>	<b>5</b>
<b>H.8.GENERAL REQUIREMENTS .....</b>	<b>5</b>
<b>H.9.IDENTIFICATION .....</b>	<b>6</b>
<b>H.10. STORAGE AND PRESERVATION.....</b>	<b>6</b>
<b>H.11. HANDLING AND TRANSPORT.....</b>	<b>6</b>



## **H.1. SCOPE**

This ANNEX determines the minimum required conditions for the fabrication, qualification and purchase of fiberglass reinforced thermoset resin based composite (FRP) piping and fittings systems, for offshore applications. The nominal diameters vary from 1" to 48", for several aqueous products.

## **H.2. REFERENCES**

Note: The Standards referred herein shall be considered in their latest edition/revision.

ISO 14692 - Petroleum and Natural Gas Industries - Glass-Reinforced Plastics (GRP) piping (parts 1 to 4);

ASTM F 1173 – Standard Specification for Thermosetting Resin Fiberglass Pipe Systems to Be Used for Marine Applications;

IMO Resolution A.753 (18): 1993 – Guidelines for the application of plastic pipes on ships;

EN-DIN 13121 – GRP tanks and vessels for use above ground

NORSOK M 622 - Fabrication and installation of GRP piping systems;

I-ET-3010.00-1200-200-P4X-003 - Design, Construction and assembly of FRP Piping

## **H.3. SYMBOLS AND ABBREVIATED TERMS**

For the purposes of this document, the following terms and definitions apply:

FRP – Fiber-Reinforced Plastic

## **H.4. FABRICATION PROCESS**

Pipes and fittings shall be manufactured by filament winding of fiberglass beams (rovings) impregnated with resin, following ISO 14692 - Part 2.

### **H.4.1. CHEMICAL BARRIER**

The chemical barrier shall be used only for aggressive fluids (acidic and base solutions, other chemical compounds, like sodium hypochlorite). In this cases, the barrier shall be at least 2.5 mm thick. The resin content is indicated to be between 55% and 75%. Chemical barriers thicknesses shall be calculated considering EN 13121-2 standard for fluids other than water.

### **H.4.2. STRUCTURAL LAYER**

This layer shall be made of thermosetting resin reinforced with fiberglass type E or E-CR. The same resin shall be applied to the internal liner and chemical barrier (if applicable). If not, the resins shall have at least the same base (epoxy or vinyl ester) and be compatible, to promote strong interaction between the layers. This layer shall be free of pigments.

### **H.4.3. EXTERNAL LINER**

The external layer shall consist of pure resin, the same used in structural layer, or have a polyester veil for improved protection. It shall contain dark pigment (with carbon black) or be without pigmentation, in order to be painted. The formulation of this layer shall contain additives for 50 years life UV protection.

Graphite shall be added to the resin to decrease the surface resistivity. "Rovings" of carbon fibers may be added during the manufacturing process to ensure electrical continuity, complementing the graphite. It is not acceptable color variation in the same tube and it shall have a polished / smooth aspect.

At least, the outer layer shall have a thickness of 0.5 mm.

#### **H.4.4. ADDITIVES**

The epoxy resin shall be pigmented with dark colors, which contain the carbon black pigment, as secondary protection to ultraviolet radiation. The lack of pigmentation is also an option, to facilitate inspection.

It is mandatory that all vinyl-ester pipes and fittings have, in their outer layers, the anti-UV additive in sufficient concentration, considering life cycle of 50 years.

Graphite and carbon black can be used as an additive to the resin as a way of decreasing the surface resistivity. This can be used as an alternative to the application of carbon fibers (rovings) in the last (outer) layers, with the same purpose. The electrical resistivity shall be calculated according to ISO 14692 – part 2 – Annex G. For reaching volumetric electrical resistivity requirements, it shall be used carbon fiber rovings in pipe structure, tested as ISO 14692 – part 2 – code C1a.

Flame retardants additives such as antimony trioxide or tri-hydrated alumina, when applied shall be at the concentration indicated by the manufacturer, accomplishing fire endurance and fire reaction requirements of the qualification program ISO 14692.

#### **H.5. MINIMUM STRUCTURAL THICKNESS**

The total thickness of a tube made of FRP is defined as the sum of the thickness of the structural layer, with the inner or internal liner, the chemical barrier layer and the outer or external liner. The structural calculations shall be according to ISO 14692-2 and consider only the structural layer as thickness for calculations.

The minimum structural thickness shall be 5.0 mm, for diameter equal or larger than 100 mm (4").

#### **H.6. MATERIALS SELECTION**

The recommended manufacturing materials for the tubes depend on the fluid being transported, according to Table H.1. Owner and manufacturer are responsible for the final decision of materials to be used.

For produced water and fire water applications, it shall be used specific epoxy resin + curing agent for continuous operation of 120°C.

Table H.1 – Required materials for pipe manufacturing as a function of service fluid.

SERVICE	STRUCTURAL LAYER	CHEMICAL BARRIER
Aerated Sea Water Injection Water Others Waters	Bisphenol A Epoxy resins (DGEBA) (note 1), reinforced with fiberglass (type E ou E-CR)	–
Fire Water (note 3) Produced Water	Bisphenol A Epoxy resins (DGEBA), reinforced with fiberglass (type E ou E-CR)	–
Concentrated Sodium hypochlorite	Epoxy vinylester resin (bisphenol A or brominated) reinforced with fiberglass (type E- CR). (note 2)	Epoxy vinylester resin (bisphenol A or brominated) reinforced with fiberglass (type E- CR). (note 2)
<b>Note 1:</b> Curing agents, aromatic or aliphatic cycle, must be used for epoxy resin. An alternative is the use of vinyl ester resin. In special cases, other resins and curing agents may be used if approved by PETROBRAS.		
<b>Note 2:</b> The cure of vinyl ester resin for use with sodium hypochlorite should be with BPO/DMA (no cobalt). A Post-cure should be applied and the chemical barrier shall be a minimum of 2.5 mm plus 0.5 mm liner. The use of brominated vinylester resin is mandatory.		
<b>Note 3:</b> Fire water systems in FRP (ring main and wet/dry deluge) are only permitted for fixed platforms in Petrobras. The fire integrity level (L1, L2, L2W, L3 or LWD) shall be designed for each part of the system.		

## H.7. FIRE PERFORMANCE

For the purposes of this document the FRP pipes and fittings shall attend at minimum to L3 IMO A.753 (18) requirements.

Fire Protection Coating: For pipes to be applied in unprotected location, without physical protection and with high possibility of being hit by fire (considered in fire propagation study or indicated by Process Safety Risk Analysis), or fire water pipes, the intumescent coating shall be applied externally to the pipe and fittings. The specification of this coating shall have the approval of owner, as its qualification shall be proven by certification tests.

The tests described in ISO 14692 / ABNT NBR 15921 - Part 2 - Item 6.5 and Appendix E are equivalent to tests of IMO Resolution A.753, as described in item E.1.1. For the purposes of this document, manufacturers shall conduct tests according to IMO A.753 for pipes and fittings and these shall receive the L1, L2, L3, L2W and LWD classifications.

## H.8. GENERAL REQUIREMENTS

In order to minimize water hammer occurrence, butterfly and gate valves shall be preferentially selected.

Shall be followed the criteria for design, construction, assembly and inspection of FRP piping system established in the technical specification I-ET-3010.00-1200-200-P4X-003.

## **H.9. IDENTIFICATION**

Identification of pipes and fittings shall be in accordance with ISO 14692 - Part 2 - Item 9.

## **H.10. STORAGE AND PRESERVATION**

The storage and preservation of items of composite pipe shall be in accordance with ISO 14692 - part 4 - Annex B.

## **H.11. HANDLING AND TRANSPORT**

The handling and transportation of composite piping items shall be in accordance with ISO 14692 - part 4 - Annex B.

# **ANNEX K**

## **PRESSURE-SAFETY VALVES (Mandatory)**



## INDEX

<b>K.1.SCOPE .....</b>	<b>4</b>
<b>K.2.NORMATIVE REFERENCES .....</b>	<b>4</b>
<b>K.3.SYMBOLS AND ABBREVIATED TERMS .....</b>	<b>4</b>
<b>K.4.VALVE SELECTION GUIDE .....</b>	<b>4</b>
<b>K.5.GENERAL DESIGN REQUIREMENTS .....</b>	<b>5</b>
<b>K.6.VALVE CODE RULE.....</b>	<b>5</b>
<b>K.7.TRIM MATERIAL.....</b>	<b>6</b>
<b>K.8.APPLICATION TABLE.....</b>	<b>7</b>
<b>K.9.PSV VALVES DATASHEETS .....</b>	<b>11</b>

## TABLES

TABLE K.1 – DEFINITION OF ACCUMULATED ENERGY AND HIGH DEMAND.....	4
TABLE K.2 – VALVE SPECIFICATION LEVEL (VSL) CLASSIFICATION.....	5
TABLE K.3 – CODE FOR FLANGE CLASS .....	6
TABLE K.4 – BODY MATERIAL CLASS ACCORDING TO MATERIAL TYPE AND NUMBER...	6
TABLE K.5 – TRIM MATERIAL CONFIGURATION FOR PSVS.....	7
TABLE K.6 – APPLICABLE SPECS PER VALVE CODE.....	7

### K.1. SCOPE

This document defines minimum technical requirements and conditions for purchasing pressure-safety valves (PSV) for Exploration and Production (E&P) business area, onshore and offshore, especially in oil and gas production and their process facilities.

### K.2. NORMATIVE REFERENCES

- API STD 520 - Sizing, Selection, and Installation of Pressure-relieving Devices Part I
- API STD 520 - Sizing, Selection, and Installation of Pressure-relieving Devices in Refineries Part II
- API STD 526 - Flanged Steel Pressure-relief Valves
- API STD 527 - Seat Tightness of Pressure Relief Valves

### K.3. SYMBOLS AND ABBREVIATED TERMS

For the purposes of this annex, the following symbols and abbreviated terms apply:

- P&ID Process and instrumentation diagram
- PSV Pressure Safety Valve / Pressure Relief Valve
- VDS Valve Datasheet
- VSL Valve Specification Level
- SPEC Piping material specification

### K.4. VALVE SELECTION GUIDE

This item presents general information, such as a guide of how shall be conducted the engineering process to select a valve for use in the Project and/or specific application.

The indication of all valves shall be driven by the definition of Valve Specification Level (VSL), which regulates the specification of an adequate valve for a certain application, taking into account the criticality foreseen in the application/use of the valve.

The VSL classification will provide two levels of specification: VSL-1 and VSL- 2. These two VSLs designations define different levels of technical requirements. For VSL-1, the leakage acceptance criteria is in accordance with API 527. For VSL-2, the leakage acceptance criteria shall be half of those presented in API 527.

The determination of the VSL is obtained by the classification rules stated on Table K.1 and Table K.2.

The manufacturer of the valve shall attend all requirements listed in the VDS, including the specific requirements of VSL.

Table K.1 – Definition of accumulated energy and high demand

<b>Accumulated Energy</b>	<b>High</b>	Valves of Pressure Class 600 and 900, NPS ≥ 6 Valves of Pressure Class 1500, 2500 and 10.000psi
	<b>Low</b>	Valves of Pressure Class 125, 150 and 300 Valves of Pressure Class 600 and 900, NPS ≤ 4

Table K.2 – Valve Specification Level (VSL) classification

	Service	Accumulated Energy	VSL
Other valves	Hydrocarbon Hot water Inflammable Steam Toxic	High	VSL-2
		Low	VSL-2
	Other services	High	VSL-2
		Low	VSL-1

## K.5. GENERAL DESIGN REQUIREMENTS

Orifice calculations shall be done according to API STD 520.

PSV design shall be according the standards referenced in the VDS. In case of conflict between the requirements herein established and that standard, the attendance of this document shall be considered as mandatory.

The manufacturer shall present all dimensional drawings of the PSV, with a list of all parts and materials specifications.

All metallic materials shall have a mill certification, with registers of chemical composition, mechanical properties and other standards requirements, besides the manufacturer batch identification.

### K.5.1. MARKING AND NAMEPLATE

All valves shall be marked in accordance with the requirements stated on the design standard referenced in the VDS.

Each valve shall be provided with an austenitic stainless steel nameplate securely affixed and so located that it is easily accessible.

The nameplate shall present information in accordance with the requirements stated on the design standard referenced in the respectively VDS, plus the additional data:

- a) Indication about the VSL of the valve: VSL-1 or VSL-2.
- b) PSV tag informed in P&ID.

## K.6. VALVE CODE RULE

All PSVs specified for application in Exploration and Production (E&P) oil production and process facilities have a unique code, in order to have uniformity and to systematize the coding of PSVs so that they can be handled in an organized manner and information can be easily retrieved.

The complete structure of all PSV codes shall be as follows:

PSV-XY-Z-MMAB

Where:

X – Upstream flange class, in accordance with table K.3;

Y – Downstream flange class, in accordance with table K.3;

Z – Valve Specification Level (VSL), in accordance with table K.2;

MM – PSV Body Material Class, according to Table K.4;

A – Valve Type (0 = Conventional; 1 = Balanced with trim A; 2 = Balanced with trim B);

B – Orifice designation, as per API 526.

Table K.3 – Code for flange class

Pressure Class	150	300	600	900	1500	2500	10000
Code X and Y	B	C	E	F	G	H	J

Table K.4 – Body Material class according to material type and number

Material number	Material type			
	C	D	N	S
	Carbon steel	Duplex steel	Nickel alloys	Stainless steel
1	ASTM A216 WCB	-	Inconel 625 (UNS N06625)	-
2	ASTM A352 LCB	ASTM A995 Gr. 4A	-	ASTM A351 Gr. CF8M
3	-	ASTM A995 Gr 6A	-	-
8	ASTM A216 WCB + PTFE / PFA			

Example: PSV-GC-2-S21K  
 Upstream flange class (G): 1500  
 Downstream flange class (C): 300  
 VSL: 2  
 PSV Body Material Class (S2): ASTM A351 CF8M  
 Valve Type (1): balanced with trim A  
 Orifice designation: K (effective area = 1.838 in<sup>2</sup>)

## K.7. TRIM MATERIAL

Materials for internal parts (trim) are described in VDSs (item K.9). The criterion for their selection is in accordance with Table K.5.



Table K.5 – Trim material configuration for PSVs

Material Class	Body Material	Bonnet material	Disc Material	Nozzle Material	Guide	Stem (spindle)	Spring	Bellows
C1	ASTM A216 Gr WCB	ASTM A216 Gr WCB	Martensitic SS 400 Series	AISI 316	AISI 316	Martensitic SS 400 Series	UNS N07750	UNS N06625
C2	ASTM A352 Gr LCB	ASTM A352 Gr LCB	AISI 316 + Stellite	AISI 316	AISI 316	AISI 316		
C8	ASTM A216 WCB + PTFE / PFA	ASTM A216 WCB + PTFE / PTFE	PTFE / PFA	PTFE / PFA	AISI 316	UNS N06455		PTFE / PFA
D2	ASTM A995 4A	ASTM A995 4A	ASTM A479 (UNS S31803)	ASTM A479 (UNS S31803)	UNS S31803	UNS S31803		UNS N06625
D3	ASTM A995 6A	ASTM A995 6A	ASTM A479 (UNS S32760)	ASTM A479 (UNS S32760)	UNS S32760	UNS S32760		
N1	UNS N06625	UNS N06625	UNS N06625	UNS N06625	UNS N06625	UNS N06625		
S2	ASTM 351 CF8M	ASTM A351 CF8M	AISI 316 + Stellite	AISI 316	AISI 316	AISI 316		
D3 Type 2 (trim B)	ASTM A995 6A	ASTM A995 6A	Hastelloy C	Hastelloy C	UNS S32760	UNS S32760		

Note 1: Sliding elements and threaded components shall have a hardness and surface finish to avoid galling.

## K.8. APPLICATION TABLE

Table K.6, below presents all possible valve codes and their respective applicable specs. All possible orifices for each valve code are applicable, as presented in third column of the Table K.6.

Table K.6 – Applicable specs per valve code

VALVE DATASHEET	SPEC	ORIFICES
PSV-BB-1-C10	B4 B5 B9 B10 B17 B10H	D, E, F, G, H, J, K, L, M, N, P, Q, R, T
PSV-BB-2-C10		
PSV-BB-1-C11		
PSV-BB-2-C11		
PSV-BB-2-C81	B27	D, E, F, G, H, J, K, L, M, N, P, Q, R, T
PSV-CB-1-C10	C4 C5 C9 C10 C10P C10H	D, E, F, G, H, J, K, L, M, N, P, Q, R, T
PSV-CB-2-C10		
PSV-CB-1-C11		
PSV-CB-2-C11		
PSV-EB-1-C10	E4 E5 E9 E10 E10R E17	D, E, F, G, H, J, K, L, M, N, P, Q, R, T
PSV-EB-2-C10		
PSV-EB-1-C11		
PSV-EB-2-C11		
PSV-FB-1-C10	F4 F5 F10 F10R	H, J, K, L, M, N, P
PSV-FB-2-C10		
PSV-FB-1-C11		

PSV-FB-2-C11		D, E, F, G,
PSV-FC-1-C10		
PSV-FC-2-C10		
PSV-FC-1-C11		
PSV-FC-2-C11		
PSV-GB-2-C10	G4 G5 G10 G10P G10R	L
PSV-GB-2-C11		
PSV-GC-2-C10		D, E, F, G, H, J, K
PSV-GC-2-C11		
PSV-HC-2-C10	H5 H10 H10P	D, E, F, G
PSV-HC-2-C11		
PSV-BB-1-C20	B6 B9 B10 B17 B19 B10H	D, E, F, G, H, J, K, L, M, N, P, Q, R, T
PSV-BB-2-C20		
PSV-BB-1-C21		
PSV-BB-2-C21		
PSV-CB-1-C20	C6 C9 C10 C10P C10H	D, E, F, G, H, J, K, L, M, N, P, Q, R, T
PSV-CB-2-C20		
PSV-CB-1-C21		
PSV-CB-2-C21		

Table K.6 – Applicable specs per valve code (continued)

VALVE DATASHEET	SPECs	ORIFICES
PSV-EB-1-C20	E6 E9 E10	D, E, F, G, H, J, K, L, M, N, P, Q, R, T
PSV-EB-2-C20		
PSV-EB-1-C21		
PSV-EB-2-C21		
PSV-FB-1-C20	F6 F10 F10P	H, J, K, L, M, N, P
PSV-FB-2-C20		
PSV-FB-1-C21		
PSV-FB-2-C21		
PSV-FC-1-C20		D, E, F, G
PSV-FC-2-C20		
PSV-FC-1-C21		
PSV-FC-2-C21		
PSV-GB-2-C20	G6 G10 G10P G19	L
PSV-GB-2-C21		D, E, F, G, H, J, K
PSV-GC-2-C20		
PSV-GC-2-C21		
PSV-HC-2-C20	H6 H10 H10P	D, E, F, G
PSV-HC-2-C21		
PSV-BB-1-N11	B30	D, E, F, G, H, J, K, L, M, N, P, Q, R, T
PSV-BB-2-N11		
PSV-CB-1-N11	C30	D, E, F, G, H, J, K, L, M, N, P, Q, R, T
PSV-CB-2-N11		
PSV-EB-1-N11	E30	D, E, F, G, H, J, K, L, M, N, P, Q, R, T
PSV-EB-2-N11		
PSV-FB-1-N11	F30	H, J, K, L, M, N, P
PSV-FB-2-N11		
PSV-FC-1-N11		D, E, F, G
PSV-FC-2-N11		
PSV-HC-2-N11		
PSV-BB-1-D21	B16 B16H	D, E, F, G, H, J, K, L, M, N, P, Q, R, T
PSV-BB-2-D21		
PSV-CB-1-D21	C16	D, E, F, G, H, J, K, L, M, N, P, Q, R, T
PSV-CB-2-D21		
PSV-EB-1-D21	E16	D, E, F, G, H, J, K, L, M, N, P, Q, R, T
PSV-EB-2-D21		
PSV-FB-1-D21	F16	H, J, K, L, M, N, P
PSV-FB-2-D21		
PSV-FC-1-D21		D, E, F, G
PSV-FC-2-D21		

Table K.6 – Applicable specs per valve code (continued)

VALVE DATASHEET	SPEC	ORIFICES
PSV-GB-2-D21	G16 G16P	L
PSV-GC-2-D21		D, E, F, G, H, J, K
PSV-HC-2-D21	H16 H16H	D, E, F, G
PSV-BB-1-D31	B12	D, E, F, G, H, J, K, L, M, N, P, Q, R, T
PSV-BB-2-D31		
PSV-CB-1-D31	C12	D, E, F, G, H, J, K, L, M, N, P, Q, R, T
PSV-CB-2-D31		
PSV-GB-2-D31	G12 G12P	L
PSV-GC-2-D31		D, E, F, G, H, J, K
PSV-HC-2-D31	H12 H12P	D, E, F, G
PSV-BB-1-S21	B3 B6 B9 B10 B17 B19 B10H	D, E, F, G, H, J, K, L, M, N, P, Q, R, T
PSV-BB-2-S21		
PSV-CB-1-S21	C3 C6 C9 C10 C10P C10H	D, E, F, G, H, J, K, L, M, N, P, Q, R, T
PSV-CB-2-S21		
PSV-EB-1-S21	E3 E6 E9 E10	D, E, F, G, H, J, K, L, M, N, P, Q, R, T
PSV-EB-2-S21		
PSV-FB-1-S21	F3 F6 F10 F10P	H, J, K, L, M, N, P
PSV-FB-2-S21		
PSV-FC-1-S21		D, E, F, G
PSV-FC-2-S21		
PSV-GB-2-S21		
PSV-GC-2-S21	G3 G6 G10 G10P G19	L
PSV-HC-2-S21	H3 H6 H10 H10P	D, E, F, G, H, J, K
PSV-BB-1-D32	B7 B7H B14 B14H B18H, B23, B23H	D, E, F, G

## **K.9. PSV VALVES DATASHEETS**













































































































# **ANNEX L**

## **REQUIREMENTS FOR LINE BLANKS**

### **(MANDATORY)**

## INDEX

REQUIREMENTS FOR LINE BLANKS .....	1
(MANDATORY).....	1
L.1 SCOPE .....	3
L.2 REFERENCES .....	3
L.3 SYMBOLS AND ABBREVIATED TERMS .....	3
L.4 GENERAL REQUIREMENTS .....	3
L.5 MATERIALS.....	3
L.6 DIMENSIONS .....	4
L.7 MARKING.....	4
L.8 DOCUMENTATIONS.....	5



## L.1 SCOPE

This ANNEX specifies requirements for line blanks (figure-8, paddles, and paddle spacers) to attend API 6A class 10.000 flanges concerning the following topics: design, material, dimensions, inspection, marking, and documentations.

## L.2 REFERENCES

Note: The Standards referred herein shall be considered in their latest edition/revision.

ASME B 16.5, *Pipe flanges and flanged fittings*

ASME B 16.47, *Large Diameter Steel Flanges NPS 26 Through NPS 60 Metric/Inch Standard*

ASME B 16.48, *Line Blanks*

ASME B 31.3, *Process piping*

API 6A, *Specification for Wellhead and Tree Equipment*

ISO 27509, *Petroleum and natural gas industries — Compact flanged connections with IX seal ring*

N120, *Peças de Inserção entre Flanges*

## L.3 SYMBOLS AND ABBREVIATED TERMS

For the purposes of this document, the following terms and definitions apply:

NPS Nominal Pipe Size

## L.4 GENERAL REQUIREMENTS

Line blanks defined in the Figure L1 and not covered by ASME B16.48 shall have its minimum thickness evaluated by the equation presented in paragraph 304.5.3 of ASME B31.3.

Those line blanks not specified by ASME B16.48 or paragraph 304.5.3 of ASME B31.3 shall be designed according to the paragraph 304.7.2 of ASME B31.3.

For class 10.000, paddles and spacers shall be used rather than figure-8 (spectacles blind).

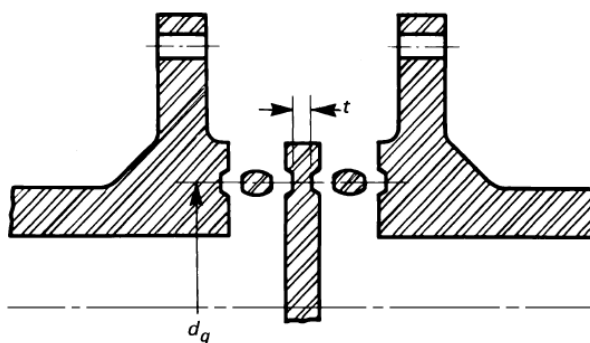

Figure L1 – Type of blank applied to API 6A flanges (REF.: ASME B31.3 para. 304.5.3).

## L.5 MATERIALS

Materials and coating shall be in accordance with chapter 3 of ASME B31.3 specification and piping spec sheet.

## L.6 DIMENSIONS

The paddles and spacers have their dimension described by Table L1. Any different spec not listed in Table L1 shall attend the requirements of ASME B31.3 and the dimensions of API 5A BX flanges.

Table L1 -Dimensions (mm) of paddle blanks and paddle spacers of class 10,000 for spec J10, J12, J12P, J31, J31P, J40, and J40P.

Outside diameter of the paddle or spacer (mm)	Inside diameter of the spacer (mm)	Groove number	Nominal size of flange	Depth of Groove (E) (mm)	Width of Groove (N) (mm)	Pitch Diameter of Groove (dg) (mm)	Thickness (mm) J10	Thickness (mm) J12 and J12P	Thickness (mm) J31 and J31P	Thickness (mm) J40 and J40P
105.00	46.70	BX 151	1.81	5.56	11.84	65.93	27.62	25.31	29.09	24.63
111.00	53.10	BX 152	2.06	5.95	12.65	73.58	30.13	27.74	31.77	26.97
132.00	65.80	BX 153	2.56	6.75	14.07	88.70	35.15	32.59	37.12	31.67
152.00	78.50	BX 154	3.06	7.54	15.39	103.61	40.10	37.38	42.40	36.31
185.00	103.90	BX 155	4.06	8.33	17.73	132.89	48.30	45.26	51.25	43.89
302.00	180.10	BX 156	7.06	11.11	23.39	218.44	73.20	69.23	78.04	66.97
359.00	229.40	BX 157	9.00	12.70	26.39	272.67	88.64	84.08	94.69	81.26
429.00	280.20	BX 158	11.00	14.29	29.18	328.05	104.33	99.18	111.61	95.79
518.00	347.00	BX 159	13.63	15.88	32.49	400.15	123.81	117.88	132.69	113.74
518.00	347.00	BX 160	13.63	14.29	19.96	388.04	117.89	112.10	126.51	108.08
576.00	426.20	BX 161	16.75	17.07	23.62	474.32	142.96	136.22	153.48	131.31
576.00	426.20	BX 162	16.75	8.33	17.91	460.42	122.34	115.75	132.55	110.99
697.00	477.00	BX 163	18.75	18.26	25.55	537.95	159.72	152.30	171.66	146.73
697.00	477.00	BX 164	18.75	18.26	32.77	545.13	161.34	153.84	173.44	148.20
781.00	540.50	BX 165	21.25	19.05	27.20	605.36	176.54	168.39	189.97	162.12
781.00	540.50	BX 166	21.25	19.05	34.87	613.01	178.27	170.03	191.87	163.69
221.00	131.10	BX 169	5.13	9.53	16.92	159.74	56.77	53.44	60.31	51.79
359.00	229.40	BX 170	9.00	8.33	17.91	202.97	64.14	60.34	68.64	58.24
429.00	280.20	BX 171	11.00	8.33	17.91	252.37	75.31	70.98	80.91	68.36
518.00	347.00	BX 172	13.63	8.33	17.91	318.01	90.14	85.10	97.20	81.81

## L.7 MARKING

The marking shall be applied by steel stamping or other marking device that leaves a legible imprint. When marking on the blind portion of the blanks, low stress marking shall be used and shall not impinge on the gasket seating surface.

Line blanks shall be marked with manufacturer's name, material specification, pressure class, and size (NPS).

The spacer shall have a hole of 6 mm in its web body to differentiate from paddle blank.

The paddle shall be stamped with the word "Blank".

## **L.8 DOCUMENTATIONS**

The Blanks not covered by ASME B16.48 or not defined by this annex shall contain the project drawings with the main dimensions and the calculation records used in their sizing.