	TECHNICAL SPECIFICATION ^{No:} I-ET-3000.00-0000-940-P4X-002	SHEET: 1 of 124
	CLIENT:	
	JOB:	--
	AREA:	
SRGE	TITLE: SYMBOLS FOR PRODUCTION UNITS DESIGN	INTERNAL ESUP

MICROSOFT WORD / for Microsoft 365 MSO (16.0.13001.20366) 64 bits / I-ET-3000.00-0000-940-P4X-002_F.DOCX

INDEX OF REVISIONS

REV.	DESCRIPTION AND/OR REVISED SHEETS
0	ORIGINAL ISSUE
A	NEW ITEMS 3.2.14, 3.2.48, 3.4.15, 3.4.35 TO 3.4.37, 10.1.26, 10.2.11, 10.3.2, 10.3.5, 10.3.8, 10.4.14, 10.5.13, 10.6.7, 10.7.5, 10.7.17, 10.7.18, 10.8.13, 10.9.4, 10.11.5 TO 10.11.18 AND CHANGE IN DESCRIPTION OF ITEMS 3.2.7, TO 3.2.13, 10.1.25, 4.9.4, 5.2.1, 10.1.4, 10.1.25, 10.2.1, 10.2.12, 10.3.6, 10.9.7, 10.10.1, 10.11.5, 10.11.6. NEW TYPES OF PUMPS ADDED IN ITEM 3.7.3. NOTES FROM ITEM 3.2 REVISED.
B	CHANGES IN HEADING OF COVER PAGE; CHANGES IN DESCRIPTION OF ITEMS 5.2.1.1 TO 5.2.1.54; NEW ITEM 3.2.15.
C	NEW ITEMS 4.7.15 AND 4.7.16.
D	CHANGES IN ITEM 3.2.16 (CHEMICAL INJECTION POINT); NEW ITEMS 5.2.1.56, 5.2.1.58, 5.2.1.60, 5.2.1.62 (FLOODLIGHT – POLE INSTALLATION); NEW ITEMS 5.2.2 (CABLE TRAY) AND 5.2.2.1 (SUPPORT FOR CABLE TRAY).
E	CHANGES IN ITEM 3.2.16 (SAMPLE CONNECTION FOR SEWAGE TREATMENT UNIT), 3.2.17 (CHEMICAL INJECTION POINT), 3.4.2 (KNIFE GATE VALVE / SLUICE GATE VALVE), 3.14.24 (SAFE LOCATION TAG LABEL)
F	CHANGES IN ITEM 3.2.9 (GAS SAMPLER)

	REV. 0	REV. A	REV. B	REV. C	REV. D	REV. E	REV. F	REV. G	REV. H
DATE	AUG/06/18	JUL/08/20	APR/25/21	DEC/03/21	NOV/17/22	JUL/17/24	JUL/22/24		
DESIGN	ESUP	ESUP	ESUP	ESUP	ESUP	ESUP	ESUP		
EXECUTION	PBORDEIRA	IDOURADO	U4KZ	ACEA	CSJ8	CSJ8	DXUC		
CHECK	LEONOGUEIRA	PEDRO	CQG8	CQG8	U4KZ	U4KZ	U4KZ		
APPROVAL	BRANDAO	BRANDAO	HR8P	U4KZ	HR8P	HR8P	HR8P		

INFORMATION IN THIS DOCUMENT IS PROPERTY OF PETROBRAS, BEING PROHIBITED OUTSIDE OF THEIR PURPOSE

FORM OWNED TO PETROBRAS N-381 REV. L



TECHNICAL SPECIFICATION	No.	I-ET-3000.00-0000-940-P4X-002	REV.	F
AREA:			SHEET:	2 of 124
TITLE:	SYMBOLS FOR PRODUCTION UNITS DESIGN		INTERNAL	
			ESUP	

SUMMARY

1.	SCOPE.....	5
2.	REFERENCES AND REMARKS	5
2.1.	REFERENCES	5
2.2.	GENERAL REMARKS	5
3.	EQUIPMENT AND PIPING	6
3.1.	TRACING LINES.....	6
3.2.	LINE ACCESSORIES	7
3.3.	HEATING AND INSULATION	13
3.4.	VALVES (SPECIAL TYPES FOR FLOW SHEETS)	13
3.5.	EQUIPMENT DRIVERS	16
3.6.	FILTERS.....	17
3.7.	PUMPS.....	18
3.8.	COMPRESSORS	21
3.9.	HEAT EXCHANGERS	22
3.10.	PRESSURE VESSELS, TANKS AND TOWERS.....	24
3.11.	MISCELLANEOUS	27
3.12.	EQUIPMENT COMPONENTS.....	34
3.13.	FIRE-FIGHTING SYMBOLS	39
3.14.	LABELS AND BREAKS	42
3.15.	SYMBOLOLOGY FOR SAFETY PLANS	44
4.	AUTOMATION	45
4.1.	INSTRUMENTATION LINES	45
4.2.	HARDWARE-BASED INSTRUMENTS.....	46
4.3.	SUPERVISORY SYSTEM OR FOUNDATION FIELDBUS FUNCTIONS	47
4.4.	COMPUTER FUNCTIONS	47
4.5.	PLC FUNCTIONS	48
4.6.	INSTRUMENTED VALVES.....	48
4.7.	ACTUATORS AND OPERATORS.....	50
4.8.	SELF-ACTUATED DEVICES.....	52
4.9.	FLOW PRIMARY ELEMENTS	54
4.10.	SEVERAL GENERAL REPRESENTATIONS.....	56
4.11.	ACCESSORIES	57
4.12.	SYMBOLS FOR EMERGENCY SHUT-DOWN DIAGRAMS.....	57



TECHNICAL SPECIFICATION AREA: TITLE:	No.	I-ET-3000.00-0000-940-P4X-002	REV.	F
	SHEET:		3	of 124
	INTERNAL			
SYMBOLS FOR PRODUCTION UNITS DESIGN		ESUP		

4.13.	SIMPLIFIED SYMBOLOGY FOR INSTRUMENTATION IN PIPING AND INSTRUMENTATION DIAGRAMS (P&IDs).....	57
4.14.	SYMBOLOGY FOR INSTRUMENTATION ON SAFETY PLANS.....	57
4.15.	MODELLING EXAMPLES FOR INSTRUMENTATION	58
5.	ELECTRICAL.....	67
5.1.	DIAGRAMS.....	67
5.2.	INSTALLATION	85
6.	PROCESS.....	92
6.1.	PROCESS FLOW DIAGRAMS AND P&IDS	92
6.2.	UTILITY AND FACILITY CODES TO BE USED IN PIPING AND INSTRUMENTATION DIAGRAMS (P&IDs).....	92
7.	AIR CONDITIONING AND VENTILATION	99
7.1.	EQUIPMENT	99
7.2.	LINE ACCESSORIES	100
7.3.	SUNDRIES	102
7.4.	ROOMS.....	103
8.	ARCHITECTURE	103
9.	NAVAL	103
9.1.	LINE ACCESSORIES	103
9.2.	EQUIPMENT DRIVERS (PUMPS)	107
9.3.	EQUIPMENT DRIVERS (MOTOR AND ENGINES).....	107
9.4.	EQUIPMENT DRIVERS (OTHER ITEMS).....	107
10.	TELECOMMUNICATION	107
10.1.	PUBLIC ADDRESS AND GENERAL ALARM SYSTEM.....	107
10.2.	TELEPHONE SYSTEM.....	110
10.3.	TRANSMISSION SYSTEM	112
10.4.	OPERATIONAL RADIO SYSTEM	113
10.5.	ANTENNAS SYSTEM.....	114
10.6.	TELECOMMUNICATION ENERGY SYSTEM	115
10.7.	DATA COMMUNICATION SYSTEM.....	116
10.8.	TV SYSTEM	118
10.9.	UHF ACTIVE REPEATER SYSTEM.....	120
10.10.	VIDEOCONFERENCE SYSTEM.....	121
10.11.	CLOSED-CIRCUIT TELEVISION SYSTEM - CCTV	122
10.12.	PARTS AND ACCESSORIES FOR INSTALLATION.....	123
11.	STRUCTURE	124



TECHNICAL SPECIFICATION

No.

I-ET-3000.00-0000-940-P4X-002

REV.

F

AREA:

SHEET:

4 of 124

TITLE:

SYMBOLS FOR PRODUCTION UNITS DESIGN

INTERNAL

ESUP

11.1. TOPSIDE STRUCTURES 124

11.2. HULL STRUCTURES 124

1. SCOPE

This technical specification defines symbols that apply to the following drawings and diagrams, when issued in surface systems design:

- a. Process Flow Diagrams (PFD's) and Utility Flow Diagrams (UFD's);
- b. Piping and Instrumentation Diagrams (P&ID's);
- c. One Line and Control Diagrams;
- d. Architecture layouts;
- e. Automation and Control Architecture;
- f. Diagrams showing levels of emergency shutdown;
- g. Safety Plan;
- h. Power, Grounding and Lighting distribution plants;
- i. Installation typical details;
- j. Telecommunications arrangement (for systems, rooms and antenna deck).

2. REFERENCES AND REMARKS

2.1. REFERENCES

- I-ET-3000.00-1200-940-P4X-001 – TAGGING PROCEDURE FOR PRODUCTION UNITS DESIGN;
- ISA 5.1 2009;
- DR-ENGP-I-1.1 in its current revision;
- IMO resolutions A.952 (23) and A.654 (16);
- ISO 17631.

2.2. GENERAL REMARKS

2.2.1. Flanges shall not be shown in end connections represented in diagrams (see example below).



2.2.2. The following indications, shown below valves symbols in diagrams, stand for:

- a) "LO" → locked open valve;
- b) "LC" → locked closed valve;
- c) "CSO" → car sealed open valve;
- d) "CSC" → car sealed closed valve;
- e) "FC" → fail-close valve;
- f) "FO" → fail-open valve;
- g) "FS" → fail-stationary valve;
- h) "NO" → normally open valve;
- i) "NC" → normally closed valve;
- j) "FL" → fail-latch valve.

2.2.3. In diagrams, it is recommended that symbols are scaled keeping proportionality between its dimensions.

2.2.4. The representation of equipment actuated by drivers (such as pumps, compressors and others) shall combine the symbols assigned to the equipment itself and to its drivers.

2.2.5. The representation of actuated or operated valves (such as handwheel valves, SDVs, BDVs and others) shall combine the symbols assigned to the valve itself and to its actuators or operators, found in section 4.7.

2.2.6. In this document, symbols that can be used to represent both equipment and piping components are presented in both sections.

2.2.7. In this document, notes indicated in symbols descriptions are shown at the end of each section.

3. EQUIPMENT AND PIPING

3.1. TRACING LINES

3.1.1.  MAIN LINE OR PRIMARY LINE

3.1.2.  AUXILIARY OR SECONDARY LINE

3.1.3.  LIMIT OF PACKAGE

3.1.4.  LIMIT OF SKID

3.1.5.  LIMIT OF AREA OR AMBIENT (E. G. MODULES, ROOMS ETC) OR BOUNDARY BETWEEN TWO DIFFERENT AREAS OR SPACES (E.G. TOPSIDE AND HULL, TWO MODULES ETC)

3.1.6.  SLOPED LINE (DOWNWARD)
SLOPED LINE (UPWARD)
X = PERCENTUAL VALUE OF SLOPE

3.1.7.  UNDERGROUND PIPE

3.1.8.  TYPICAL REPRESENTATION

3.1.9.



CIVIL

3.1.10.



MODULE BREAK 2

3.1.11.



HOSE

3.2. LINE ACCESSORIES

3.2.1.

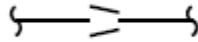

REDUCTION (CONCENTRIC)

3.2.2.

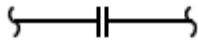

FLANGE

3.2.3.

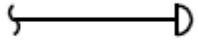

WELDED PLUG (CAP)

3.2.4.

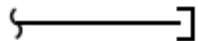

THREADED PLUG

3.2.5.



STOPPER

3.2.6.



ISOLATING JOINT

3.2.7.

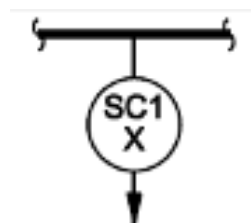

SAMPLING CONNECTION FOR LIQUIDS WITH TEMPERATURE LOWER THAN 60°C

 X=A1 (LOW PRESSURE; HOT CLEANING REQUIRED)
 X=A2 (HIGH PRESSURE; HOT CLEANING REQUIRED)
 X=A3 (LOW PRESSURE; HOT CLEANING NOT REQUIRED)
 X=A4 (HIGH PRESSURE; HOT CLEANING NOT REQUIRED)

See notes 1 and 2 at the end of this section.

3.2.8.

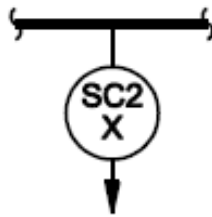

SAMPLING CONNECTION FOR LIQUIDS WITH TEMPERATURE GREATER THAN OR EQUAL TO 60 °C

X=B1 (LOW PRESSURE; HOT CLEANING REQUIRED)
 X=B2 (HIGH PRESSURE; HOT CLEANING REQUIRED)
 X=B3 (LOW PRESSURE; HOT CLEANING NOT REQUIRED)
 X=B4 (HIGH PRESSURE; HOT CLEANING NOT REQUIRED)

See notes 1 and 2 at the end of this section.

3.2.9.

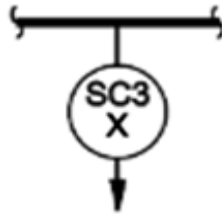

GAS SAMPLER

X=C1 (LOW PRESSURE; LOW TEMPERATURE)
 X=C2 (HIGH PRESSURE; LOW TEMPERATURE)
 X=C3 (LOW PRESSURE; HIGH TEMPERATURE)
 X=C4 (HIGH PRESSURE; HIGH TEMPERATURE)
 X=C5 (LOW LOW PRESSURE; HIGH TEMPERATURE)
 X=C6 (LOW LOW PRESSURE; LOW TEMPERATURE)
 X=C7 (HIGH HIGH PRESSURE; HIGH TEMPERATURE)

See notes 1 and 2 at the end of this section.

3.2.10.

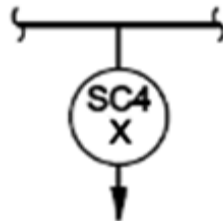

SAMPLING CONNECTION FOR LOW BSW (BSW <5%) DEAD OIL

X=D1 (LOW PRESSURE; LOW TEMPERATURE)
 X=D2 (HIGH PRESSURE; LOW TEMPERATURE)
 X=D3 (LOW PRESSURE; HIGH TEMPERATURE)
 X=D4 (HIGH PRESSURE; HIGH TEMPERATURE)

See notes 1 and 2 at the end of this section.

3.2.11.

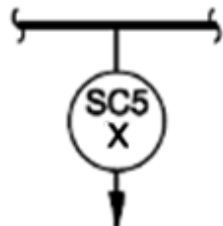

SAMPLING CONNECTION FOR HIGH BSW (BSW GREATER THAN OR EQUAL TO 5%) DEAD OIL

X=E1 (LOW PRESSURE; LOW TEMPERATURE)
 X=E2 (HIGH PRESSURE; LOW TEMPERATURE)
 X=E3 (LOW PRESSURE; HIGH TEMPERATURE)
 X=E4 (HIGH PRESSURE; HIGH TEMPERATURE)

See notes 1 and 2 at the end of this section.

3.2.12.

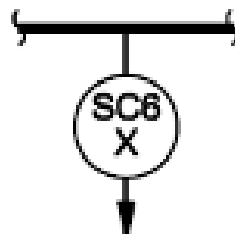

INJECTION WATER (SEAWATER OR PRODUCED WATER) SAMPLE CONNECTION

X=F1 (LOW PRESSURE; LOW TEMPERATURE)
 X=F2 (HIGH PRESSURE; LOW TEMPERATURE)

See notes 1 and 2 at the end of this section.

3.2.13.

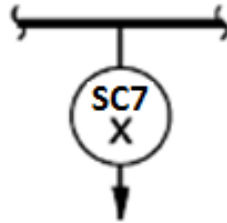
SAMPLING CONNECTION FOR LIVE OIL

X=G1 (LOW PRESSURE; LOW TEMPERATURE); NON-PRESSURIZED SAMPLING)
 X=G2 (HIGH PRESSURE; LOW TEMPERATURE); NON-PRESSURIZED SAMPLING)
 X=G3 (LOW PRESSURE; HIGH TEMPERATURE); NON-PRESSURIZED SAMPLING)
 X=G4 (HIGH PRESSURE; HIGH TEMPERATURE) NON-PRESSURIZED SAMPLING)
 X=G5 (LOW PRESSURE; LOW TEMPERATURE - PVT SAMPLING WITH CYLINDER)
 X=G6 (HIGH PRESSURE; LOW TEMPERATURE - PVT SAMPLING WITH CYLINDER)
 X=G7 (LOW PRESSURE; HIGH TEMPERATURE - PVT SAMPLING WITH CYLINDER)
 X=G8 (HIGH PRESSURE; HIGH TEMPERATURE - PVT SAMPLING WITH CYLINDER)

See notes 1 and 2 at the end of this section.

3.2.14.

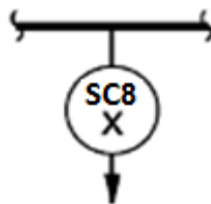
SAMPLING CONNECTION FOR PRODUCED WATER

X=H1 (LOW PRESSURE; LOW TEMPERATURE; COMPLIANCE WITH LEGISLATION)
 X=H2 (LOW PRESSURE; HIGH TEMPERATURE; COMPLIANCE WITH LEGISLATION)
 X=H3 (LOW PRESSURE; LOW TEMPERATURE; OPERATIONAL)
 X=H4 (LOW PRESSURE; HIGH TEMPERATURE; OPERATIONAL)
 X=H5 (HIGH PRESSURE; LOW TEMPERATURE; COMPLIANCE WITH LEGISLATION)
 X=H6 (HIGH PRESSURE; HIGH TEMPERATURE; COMPLIANCE WITH LEGISLATION)
 X=H7 (HIGH PRESSURE; LOW TEMPERATURE; OPERATIONAL)
 X=H8 (HIGH PRESSURE; HIGH TEMPERATURE; OPERATIONAL)

See notes 1 and 2 at the end of this section.

3.2.15.

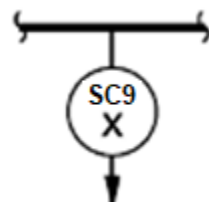
SAMPLING CONNECTION FOR STREAMS WITH BENZENE

X=I1 (LOW PRESSURE; LOW TEMPERATURE; CONDENSATE AND BIPHASIC SAMPLING)
 X=I2 (HIGH PRESSURE; LOW TEMPERATURE; CONDENSATE AND BIPHASIC SAMPLING)
 X=I3 (LOW PRESSURE; HIGH TEMPERATURE; CONDENSATE AND BIPHASIC SAMPLING)
 X=I4 (HIGH PRESSURE; HIGH TEMPERATURE; CONDENSATE AND BIPHASIC SAMPLING)

See notes 1 and 2 at the end of this section.

3.2.16.

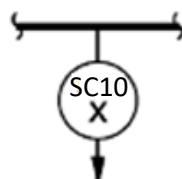
SAMPLE CONNECTION FOR SEWAGE TREATMENT UNIT (STU)

X=J1 (LOW PRESSURE; LOW TEMPERATURE)
 See notes 1 and 2 at the end of this section.

3.2.17.



CHEMICAL INJECTION POINT

(THE CIP REPRESENTATION INCLUDES INJECTION POINT AND SHUT-OFF VALVES. FOR MORE DETAILS, SEE I-ET-3010.00-1200-940-P4X-005 – CHEMICAL INJECTION POINTS)

Z:

- OPEN
- SPRAY
- QUILL

3.2.18.



BLIND FLANGE

3.2.19.

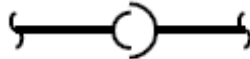

SWIVEL CONNECTION

3.2.20.

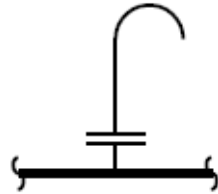

ATMOSPHERIC VENT

3.2.21.

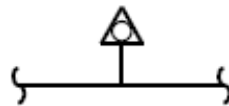

AIR GATE

3.2.22.



PULSATION DAMPENER

3.2.23.

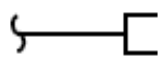

HOSE CONNECTION

3.2.24.

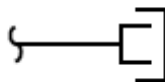

QUICK CONNECTION CAP

3.2.25.

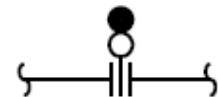

OPEN SPECTACLE BLIND

3.2.26.



CLOSED SPECTACLE BLIND

3.2.27.

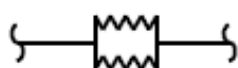

EXPANSION JUNCTION

3.2.28.



T WITH SCREEN

3.2.29.

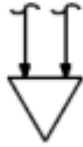

FLARE PILOT

(THIS PIPING COMPONENT ISN'T AN ACTUAL PIPING JOINT. IT'S A SIMPLE REPRESENTATION FOR PHYSIC MOUNTED SITUATION)

3.2.30.



VENT WITH FLAME SCREEN

3.2.31.

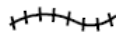

FLEXIBLE HOSE

3.2.32.

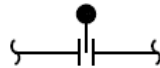

PADDLE BLIND

3.2.33.

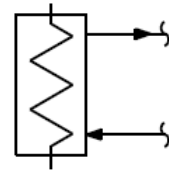

SAMPLE COOLER

3.2.34.



IN-LINE SILENCER

3.2.35.



SILENCER

3.2.36.

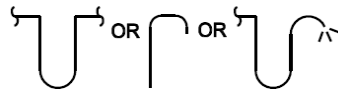

SIPHON

3.2.37.

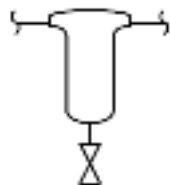

IN-LINE LIQUID SEPARATOR

3.2.38.









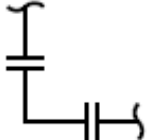

STATIC MIXER

3.2.39.

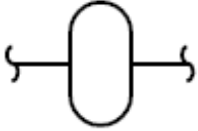
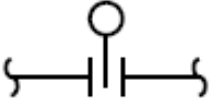

TRAP

3.2.40.		SPOOL
3.2.41.		TIE-IN POINT (EXAMPLES OF USE FOR THIS SYMBOL INCLUDE BUT ARE NOT LIMITED TO: BETWEEN FLANGES; BETWEEN A NOZZLE AND A FLANGE; IN A PIPING DERIVATION)
3.2.42.		T MIXER
3.2.43.		SPOOL 90
3.2.44.		DRAINAGE COLLECTOR
3.2.45.		CALIBRATION COLUMN
3.2.46.		SAMPLING CYLINDER
3.2.47.		PADDLE SPACER
3.2.48.		FLANGE SWIVEL
3.2.49.		PROBE
3.2.50.		SIDE SHELL PENETRATION PIECE FOR INERT GAS SYSTEM (EXTRA THICKNESS)

Notes:

(1) See P&ID – General Notes.

(2) High pressure: #300 and upper; High temperature: 60°C and upper.

3.3. HEATING AND INSULATION

3.3.1.

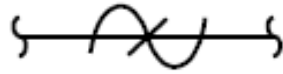

INTERNAL STEAM TRACE

3.3.2.

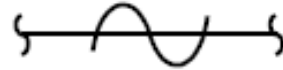

EXTERNAL STEAM TRACE

3.3.3.

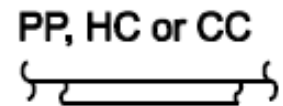

 PP: INSULATION FOR PERSONAL PROTECTION
 HC: INSULATION FOR HEAT CONSERVATION
 CC: INSULATION FOR COLD CONSERVATION

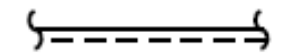
3.3.4.

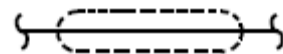

ELECTRICAL TRACE

3.3.5.



STEAM JACKET

3.3.6.



ELECTRICAL RESISTANCE HEATING

3.3.7.

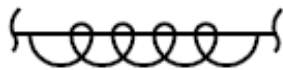

ELECTRIC INDUCTION HEATING

3.4. VALVES (SPECIAL TYPES FOR FLOW SHEETS)

3.4.1.



WEDGE GATE VALVE

3.4.2.



KNIFE GATE VALVE / SLUICE GATE VALVE

3.4.3.



EXPANDING GATE VALVE

3.4.4.



BALL VALVE (SPE X SPE)

3.4.5.



BALL VALVE DIB-2 (SPE X DPE)

3.4.6.



BALL VALVE DIB-2 (DPE X SPE)

3.4.7.



DOUBLE BALL VALVE

3.4.8.



RISING STEM BALL VALVE

3.4.9.



TRIPLE OFFSET BALL VALVE

3.4.10.



CONCENTRIC BUTTERFLY VALVE

3.4.11.



DOUBLE OFFSET BUTTERFLY VALVE

3.4.12.



TRIPLE OFFSET BUTTERFLY VALVE

3.4.13.



GLOBE VALVE

3.4.14.



Y GLOBE VALVE

3.4.15.



DOUBLE REGULATING AND COMMISSIONING GLOBE VALVE (FOR HVAC)

3.4.16.

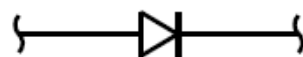

CHECK VALVE

3.4.17.

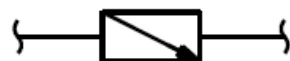

WAFER CHECK VALVE

3.4.18.



NEEDLE VALVE

3.4.19.



DIAPHRAGM VALVE

3.4.20.

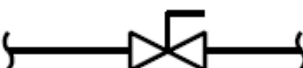

PLUG VALVE

3.4.21.



EXPANDING SLIPS PLUG VALVE

3.4.22.



AXIAL ON-OFF VALVE

3.4.23.



QUICK-ACTING VALVE

3.4.24.

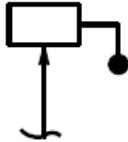

SOUNDING VALVE

3.4.25.



STORM VALVE

3.4.26.



PUMP RECIRCULATION VALVE

3.4.27.



STOP CHECK VALVE

3.4.28.



GLOBE STOP VALVE

3.4.29.



SCREW DOWN CHECK GLOBE VALVE

3.4.30.



DAMPER VALVE

3.4.31.

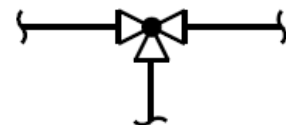

THREE-WAY BALL VALVE

3.4.32.



BLEEDER VALVE

3.4.33.



BALANCE VALVE

3.4.34.

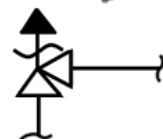

AIR RELEASE VALVE

3.4.35.

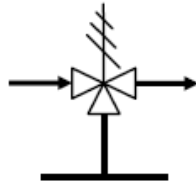
 GENERIC PRESSURE – VACUUM RELIEF VALVE
 TANK PRESSURE – VACUUM RELIEF VALVE

3.4.36.



FOOT VALVE

3.4.37.



VACUUM BREAKER

3.5. EQUIPMENT DRIVERS

3.5.1.



ELECTRIC MOTOR

3.5.2.

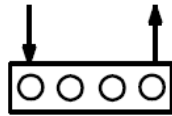

INTERNAL COMBUSTION ENGINE

3.5.3.

 VARIABLE SPEED DRIVER
 (ES: ELECTRIC SUPPLY)

3.5.4.

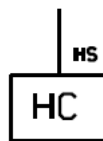

 VARIABLE SPEED - HYDRAULIC COUPLING
 (HS: HYDRAULIC SUPPLY)

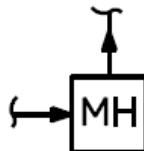
3.5.5.

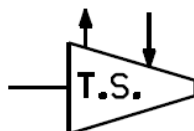

HYDRAULIC MOTOR OR TURBINE

3.5.6.



GAS TURBINE

3.5.7.

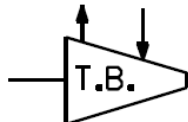

STEAM TURBINE

3.6. FILTERS

3.6.1.

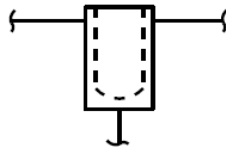

CARTRIDGE FILTER

3.6.2.

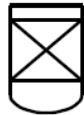

CHARCOAL/ACTIVATED CHARCOAL/CLAY FILTER

3.6.3.



MULTIMEDIA/SAND FILTER

3.6.4.

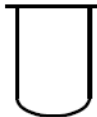

BASKET FILTER

3.6.5.

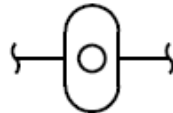

SIMPLE BASKET FILTER

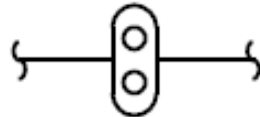

SINGLE BASKET FILTER

3.6.6.



Y FILTER

3.6.7.

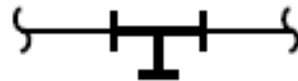

T FILTER

3.6.8.

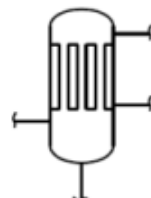

COALESCER FILTER

3.6.9.

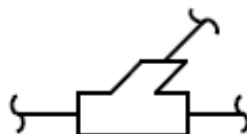

Y PIGGABLE SCREEN

3.6.10.



TEMPORARY FILTER

3.6.11.

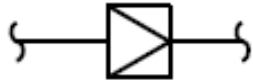

CONE STRAINER

3.6.12.

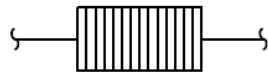
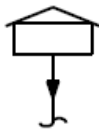

PLATE FILTER

3.6.13.



AIR FILTER SUCTION OF COMPRESSORS, TURBINES AND DIESEL ENGINES

3.6.14.

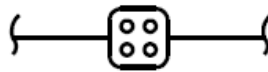

DUPLEX BASKET FILTER

3.6.15.



AUTOMATIC BACKFLUSHING OR SELF-CLEANING FILTER

3.6.16.



WALNUT FILTER

3.6.17.



BAG FILTER

3.6.18.



Y FILTER WITH DRAIN CONNECT

3.7. PUMPS

3.7.1.

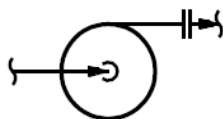

CENTRIFUGAL PUMP

3.7.2.

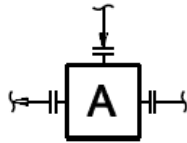

RECIPROCATING PUMP

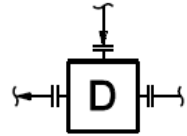

METERING PUMP

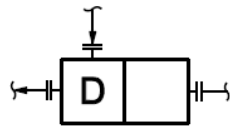

METERING PUMP 2 HEADS

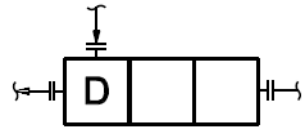

METERING PUMP 3 HEADS

3.7.3.

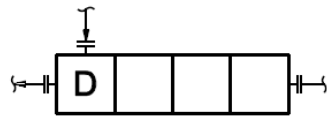

METERING PUMP 4 HEADS

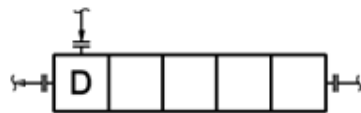

METERING PUMP 5 HEADS

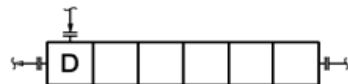

METERING PUMP 6 HEADS

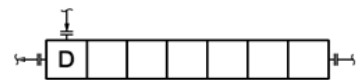

METERING PUMP 7 HEADS

3.7.4.



VERTICAL CENTRIFUGAL PUMP WITH EXTENDED SHAFT



VERTICAL CENTRIFUGAL PUMP WITH SUBMERGED MOTOR



VERTICAL CENTRIFUGAL PUMP WITH NON-SUBMERGED MOTOR

3.7.5.

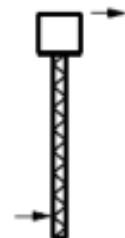

SUBMERGED VERTICAL PROGRESSIVE CAVITY PUMP

3.7.6.

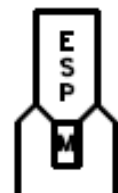

ELECTRICAL SUBMERGED PUMP

3.7.7.



SUBMERGED PUMP

3.7.8.

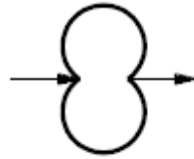

ROTARY PUMP

3.7.9.

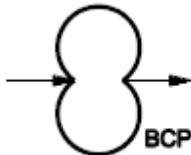

PROGRESSIVE CAVITY PUMP

3.7.10.

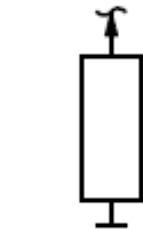

SUBMERSIBLE PUMP

3.7.11.

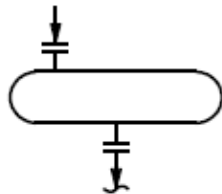
 IN LINE VERTICAL CENTRIFUGAL PUMP
DOUBLE DIAPHRAGM PUMP

3.8. COMPRESSORS

3.8.1.

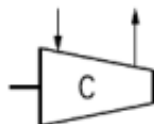

CENTRIFUGAL COMPRESSOR, 1 STAGE

3.8.2.



CENTRIFUGAL COMPRESSOR, 2 OR 3 STAGE

3.8.3.

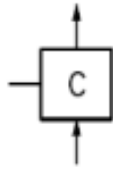

RECIPROCATING COMPRESSOR, 1 STAGE

3.8.4.

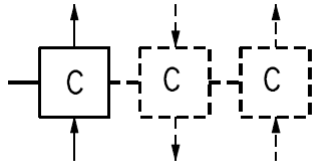

RECIPROCATING COMPRESSOR, 2 OR 3 STAGE

3.8.5.

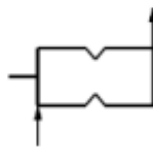

ROTARY COMPRESSOR, 1 STAGE

3.8.6.

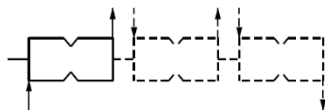

ROTARY COMPRESSOR, 2 OR 3 STAGE

3.9. HEAT EXCHANGERS

3.9.1.



COIL

3.9.2.

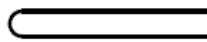

U-BEND BUNDLE

3.9.3.

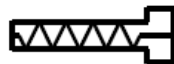

ELECTRIC BAYONET

3.9.4.

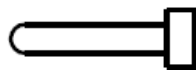

ENCAPSULATED RESISTANCE

3.9.5.

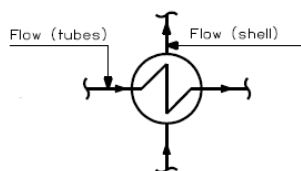

SIMPLE TUBULAR EXCHANGER

OR

SHELL AND TUBE TYPES



3.9.6.

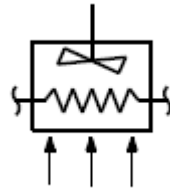

AIR COOLER (TYPE 1)

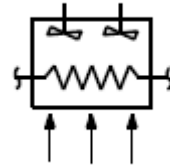

AIR COOLER (TYPE 2)

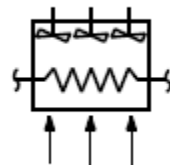

AIR COOLER (TYPE 3)

3.9.7.



PLATE HEAT EXCHANGER

3.9.8.

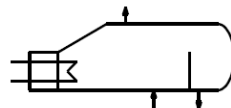

KETTLE HEAT EXCHANGER

3.9.9.

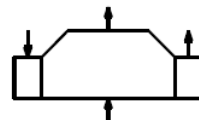

CHILLER

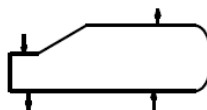

CHILLER-2

3.9.10.

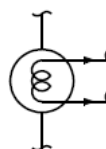

ELECTRICAL HEAT EXCHANGER

3.9.11.

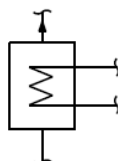

WASTE HEAT RECOVERY

3.9.12.



HEAT EXCHANGER AND CONDENSER

3.9.13.



HEAT EXCHANGER AND CONDENSER "U" TUBE

3.9.14.



CONCENTRIC TUBES EXCHANGER

3.9.15.

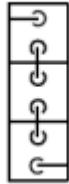

MULTIPLE CONCENTRIC TUBES EXCHANGER

3.9.16.



FLARE VAPORIZER

3.9.17.



MULTIFLOW HEAT EXCHANGER

3.9.18.



EXCHANGER WITH BOOTS

3.9.19.

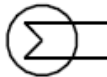

REBOILER

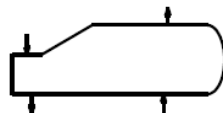

REBOILER-2

3.9.20.



HEAT EXCHANGER - TYPE PRINTED CIRCUIT

3.10. PRESSURE VESSELS, TANKS AND TOWERS

3.10.1.

 HORIZONTAL VESSEL
OIL TREATER (HORIZONTAL)

3.10.2.

 VERTICAL VESSEL
OIL TREATER (VERTICAL)

3.10.3.

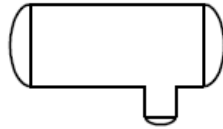

HORIZONTAL VESSEL WITH COLLECTING BOOT

3.10.4.



DEAERATOR

3.10.5.

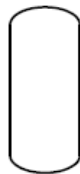

VACUUM DEAERATOR

3.10.6.

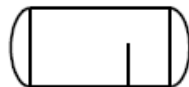

THREE PHASE SEPARATOR, TEST OR PRODUCTION SEPARATOR OR PRODUCED WATER SEPARATOR

3.10.7.

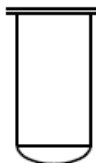

VERTICAL VESSEL WITH FLANGE

3.10.8.



TANK WITH PLAN ROOF/STRUCTURAL TANK (TYPE 1)

3.10.9.



TANK WITH CONICAL ROOF

3.10.10.



STRUCTURAL TANK (TYPE 2)

3.10.10.



CONIC BOTTOM TANK

3.10.11.

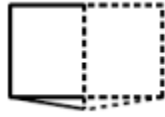

TWIN CONIC BOTTOM TANK

3.10.12.



COLUMNS WITH TWO SECTIONS

3.10.13.



RECTANGULAR TANK WITHOUT ROOF

3.10.14.



TWIN RECTANGULAR TANK WITHOUT ROOF

3.10.15.



OILY WATER SEPARATOR (PLATES)

3.10.16.



COOLING TOWER

3.10.17.

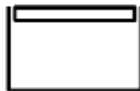

STORAGE TANK WITH FLOATING ROOF

3.10.18.



STORAGE TANK WITH EXTERNAL CONIC AND INTERNAL FLOATING ROOF

3.10.19.

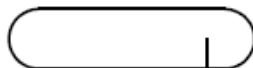

HORIZONTAL FLOTATOR

3.10.20.



DOME ROOF TANK

3.10.21.

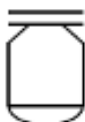

VERTICAL VESSEL WITH CONICAL TRANSITION

3.10.22.



DEMETHANIZER COLUMN

3.10.23.

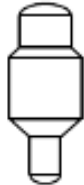

COLUMNS WITH THREE SECTIONS

3.10.24.



ELLIPTICAL BOTTOM TANK

3.10.25.



FLANGED ROOF VESSEL

3.10.26.



ELLIPTICAL EXTREMITY TANK

3.10.27.



DRAINAGE TANK

3.11. MISCELLANEOUS

3.11.1.

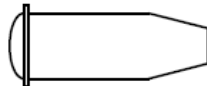

"PIG" LAUNCHER/RECEIVER

3.11.2.



DRY WELL HEAD

3.11.3.

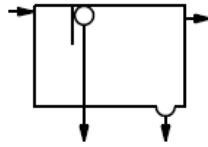

OILY WATER SEPARATOR TYPE 1

3.11.4.

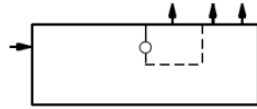

OILY WATER SEPARATOR TYPE 2

3.11.5.



BLOWER

3.11.6.

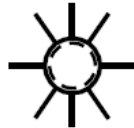

FLARE BURNER

3.11.7.



CENTRIFUGAL PURIFIER

3.11.8.

 INERT GAS CYLINDER (CO₂, N₂)

3.11.9.

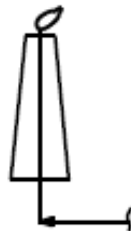

FLARE

3.11.10.



SONIC FLARE

3.11.11.



MULTI FLARE

3.11.12.



FURNACE (TYPE 1)

3.11.13.



FURNACE (TYPE 2)

3.11.14.

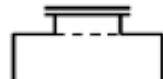

SEA CHEST

3.11.15.



CHEMICAL INJECTION VESSEL

3.11.16.

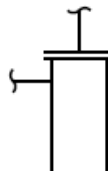

OPEN CAISSON

3.11.17.

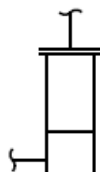

CLOSED CAISSON

3.11.18.

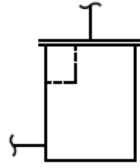

DRAINAGE CAISSON

3.11.19.

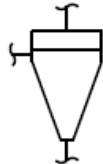

HIDROCYCLONE

3.11.20.

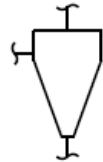

CYCLONE

3.11.21.



DESANDER

3.11.22.

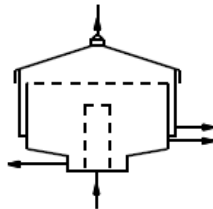

DISSOLVED GAS FLOTATION

3.11.23.

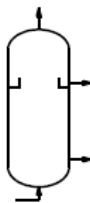

FLOTATOR (TYPE 1)

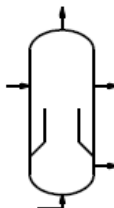

FLOTATOR (TYPE 2)

3.11.24.



EJECTOR

3.11.25.



MIXER/AGITATOR

3.11.26.



SUPPLY HOSE REEL

3.11.27.

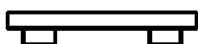

SUBMERGED WELL HEAD

3.11.28.



DRYER

3.11.29.



ELECTRICAL HEATER

3.11.30.



STACK

3.11.31.

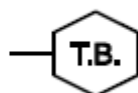

AIR TURBINE

3.11.32.



WATER TOWER

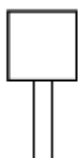

WATER TOWER WITHOUT SUPPORT

3.11.33.



BOILER (STEAM GENERATION)

3.11.34.



FURNACE (TYPE 3)

3.11.35.



FURNACE (TYPE 4)

3.11.36.



ELECTRIC FURNACE

3.11.37.

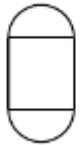

REACTOR

3.11.38.



TULIP FLARE

3.11.39.



MOLECULAR SEAL FLARE

3.11.40.

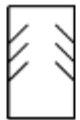

FLUIDIC SEAL FLARE

3.11.41.



PARTITION BOX

3.11.42.



ACCUMULATION BASIN

3.11.43.



SAND BOX

3.11.44.



MIXING T

3.11.45.



STATIC MIXER

3.11.46.



EDUCTOR

3.11.47.

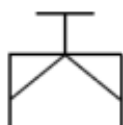

FLOODGATE

3.11.48.

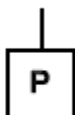

PNEUMATIC MOTOR

3.11.49.



CLEANING MACHINE PROGRAMMABLE

3.11.50.



CLEANING MACHINE NON-PROGRAMMABLE

3.11.51.

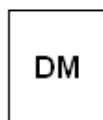

DYNAMIC MIXER

3.11.52.

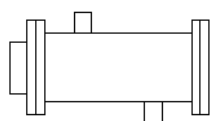

CO2 REMOVAL MEMBRANE

3.11.53.

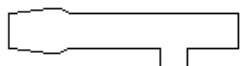

SUPERSONIC SEPARATOR

3.11.54.

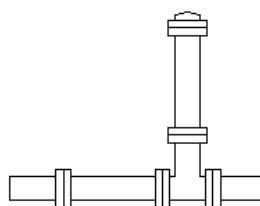

INLINE CYCLONIC SEPARATOR

3.11.55.



VERTICAL CYCLONIC SEPARATOR

3.11.56.



HYDRANT

See item 0 for details

3.11.57.

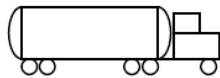

TANK-TRUCK

3.11.58.

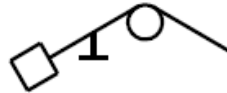

LOADING ARM - TOP

3.11.59.

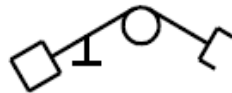

LOADING ARM - BOTTOM (GLP)

3.11.60.



LOADING ARM - BOTTOM (EXCEPT GLP)

3.11.61.

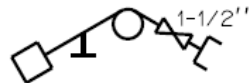

LOADING ARM WITH VALVE

3.11.62.

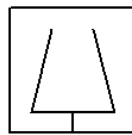

CENTRIFUGE

3.12. EQUIPMENT COMPONENTS

3.12.1.

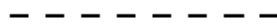

STILL BAFFLE

3.12.2.



BAFFLE/WEIR

3.12.3.



VORTEX BREAKER

3.12.4.



BED

3.12.5.



DRAINAGE BOOT

3.12.6.



FURNACE DAMPER

3.12.7.



FURNACE BURNER OR PLENUM

3.12.8.



NOZZLE TYPE 1

3.12.9.

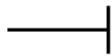

NOZZLE TYPE 2

3.12.10.

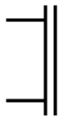

MANWAY NOZZLE TYPE 3

3.12.11.



MANWAY NOZZLE TYPE 4

3.12.12.



MANWAY NOZZLE TYPE 5

3.12.13.

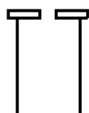

SEA WATER PUMP CASING

3.12.14.



DISTRIBUTOR TYPE 1



DISTRIBUTOR TYPE 2

3.12.15.



DEMISTER TYPE 1

3.12.16.



DEMISTER TYPE 2

3.12.17.



DEMISTER TYPE 3

3.12.18.

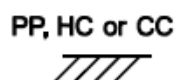
 INSULATION FOR EQUIPMENT
 PP: PERSONAL PROTECTION
 HC: HEAT CONSERVATION
 CC: COLD CONSERVATION

3.12.19.



DRIP PAN

3.12.20.



CHIMNEY TRAY

3.12.21.



BUCKET

3.12.22.



DIVERTER PLATE

3.12.23.



OVERFLOW

3.12.24.



FLANGED NOZZLE (INTERNAL)

3.12.25.



OUTPUT GAS WITH DEMISTER

3.12.26.



LIQUID CHAMBER

3.12.27.

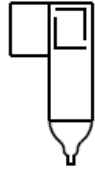

CYCLONE DEVICE

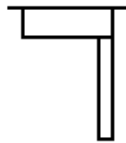

CYCLONE OUTLET

3.12.28.



SCREEN FOR CAISSON

3.12.29.



PUMP SUCTION FILTER

3.12.30.



STRAIGHT THRU COIL

3.12.31.

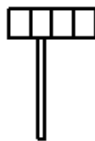

DEMISTER (TP VANE TYPE)

3.12.32.

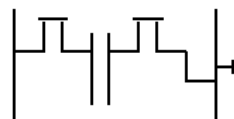

PARTIAL DRAW-OFF TRAY (TYPE 1)

3.12.33.

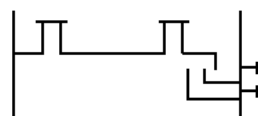

PARTIAL DRAW-OFF TRAY (TYPE 2)

3.12.34.

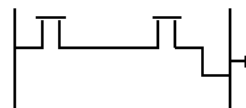

TOTAL DRAW-OFF TRAY (TYPE 1)

3.12.35.



TOTAL DRAW-OFF TRAY (TYPE 2)

3.12.36.



LIQUID DISTRIBUTORS/LIQUID REDISTRIBUTORS

3.12.37.

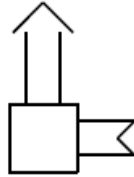

FIRETUBE

3.12.38.

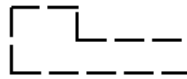

GUTTER PIPE

3.12.39.

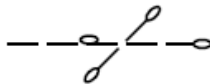

WATER SUMP

3.12.40.



INDUCTION PIPE

3.12.41.

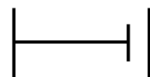

TRAY (TYPE 1)

3.12.42.

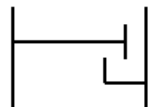

TRAY (TYPE 2)

3.12.43.

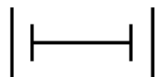

TRAY (TYPE 3)

3.12.44.

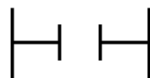

TRAY (TYPE 4)

3.12.45.

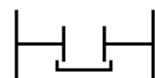

TRAY (TYPE 5)

3.12.46.



BED SUPPORT (TYPE 1)

3.12.47.



BED SUPPORT (TYPE 2)

3.12.48.



BED SUPPORT (TYPE 3)

3.12.49.



DISTRIBUTOR TYPE 3

3.12.50.



CIVIL NOZZLE

3.12.51.



SPRAY NOZZLE

3.12.52.



DOWN PIPE

3.12.53.



PARAMETRIC SIEVE TRAY

3.13. FIRE-FIGHTING SYMBOLS

3.13.1.

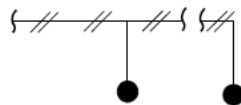

FUSIBLE PLUG LOOP FOR FIRE DETECTION

3.13.2.



WATER SPRAY NOZZLES (SPRINKLERS)

3.13.3.

 HYDRANTS (2 OUTLETS)
 $\varnothing = 2 \frac{1}{2}$ " : OUTDOOR AREAS
 $\varnothing = 1 \frac{1}{2}$ " : INDOOR AREAS AND OUTDOOR OF ACCOMODATION MODULES

FITTED WITH ANGLE VALVE (FOR STORZ TYPE CONNECTIONS)

3.13.4.

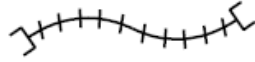

HOSE LINE (WITH STORZ TYPE CONNECTIONS)

3.13.5.



WATER MONITOR



WATER MONITOR (AUTO-OSCILATING)

3.13.6.



PORTABLE WATER MONITOR

3.13.7.



FOAM MONITOR

3.13.8.

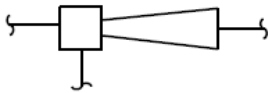

IN-LINE EDUCTOR

3.13.9.



FOAM CONCENTRATE CONTAINER WITH PICK-UP IN-LINE EDUCTOR

3.13.10.

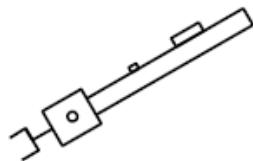

HANDLINE FOAM NOZZLE

3.13.11.

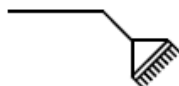

SHOWER

3.13.12.



EYE-WASH

3.13.13.

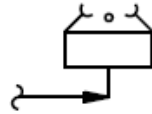

EYE-WASH (TYPE 2)

3.13.14.



SHOWER OUTSIDE AREA

3.13.15.

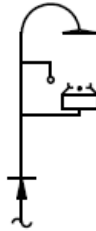

SHOWER OUTSIDE AREA WITH EYE-WASH

3.13.16.

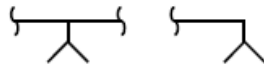

CO2 NOZZLES

3.13.17.



HYDRANTS (4 OUTLETS)

3.13.18.



HYDRANTS (4 OUTLETS) WITH MONITOR

3.13.19.



HYDRANTS (6 OUTLETS)

3.13.20.



2-WAY HYDRANT WITH MONITOR

3.13.21.



6-WAY HYDRANT WITH MONITOR

3.13.22.



DEFLECTOR

3.13.23.



CO2 BLEEDER

3.14. LABELS AND BREAKS

3.14.1.



CONSTRUCTION STATUS BREAK

3.14.2.



DESIGN RESPONSIBILITY BREAK

3.14.3.



END OF GROUP BREAK

3.14.4.



INSULATION REQUIREMENTS BREAK

3.14.5.



NOMINAL DIAMETER BREAK

3.14.6.



P-T BREAK

3.14.7.



SPECIFICATION BREAK

3.14.8.



STREAM NUMBER LABEL

3.14.9.









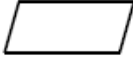
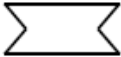
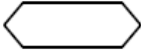
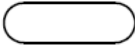

SUPPLY RESPONSIBILITY BREAK

3.14.10.

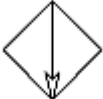

STRESS OR FLEXIBILITY BREAK

3.14.11.		<p>TIE-IN POINT TAG LABEL WHERE: X = SUBSYSTEM CODE OR AREA CODE (N-1710).</p> <p>EX.: - 501 (SUBSYSTEM CODE) - 1223 (AREA CODE) Y = TIE-IN CHRONOLOGIC SEQUENTIAL NUMBER WITH 4 NUMERIC DIGITS</p>
3.14.12.		TEMPERATURE
3.14.13.		PRESSURE
3.14.14.		STEAM FLOW RATE
3.14.15.		LIQUID FLOW RATE
3.14.16.		GAS FLOW RATE
3.14.17.		DUTY INDICATING
3.14.18.		SPECIFIC GRAVITY
3.14.19.		COATING REQUIREMENTS
3.14.20.		CONSTRUCTION RESPONSIBILITY
3.14.21.		NO P-T CONDITION BREAK
3.14.22.		HAZOP BREAK
3.14.23.		HEAT TRACING BREAK

3.14.24.



SAFE LOCATION TAG LABEL

WHERE:

X = SUBSYSTEM CODE OR AREA CODE (N-1710)

EX.:

-501 (SUBSYSTEM CODE)

-1223 (AREA CODE)









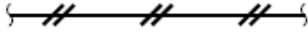
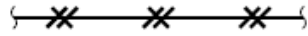
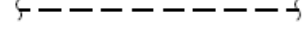
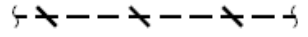
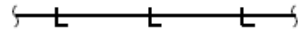
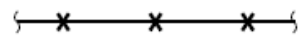
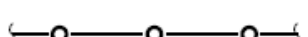

Y = SAFE LOCATION CHRONOLOGIC SEQUENTIAL NUMBER WITH 4 NUMERIC DIGITS

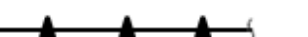
3.15. SYMBOLOGY FOR SAFETY PLANS

Symbology for Safety Plans shall be in accordance with IMO resolutions A.952 (23) and A.654 (16) and with ISO 17631.

4. AUTOMATION

4.1. INSTRUMENTATION LINES

4.1.1.		PNEUMATIC SIGNAL
4.1.2.		DISCRETE PNEUMATIC SIGNAL
4.1.3.		ANALOG ELECTRIC SIGNAL
4.1.4.		DISCRETE ELECTRIC SIGNAL
4.1.5.		HYDRAULIC SIGNAL
4.1.6.		CAPILLARY
4.1.7.		GENERIC NETWORK COMMUNICATION
4.1.8.		ETHERNET NETWORK COMMUNICATION
4.1.9.		NON-ETHERNET AND NON-OPTICAL FIBER NETWORK COMMUNICATION
4.1.10.		FIELDBUS COMMUNICATION
4.1.11.		GUIDED ELECTROMAGNETIC, ACOUSTIC SIGNAL OR FIBER OPTICS
4.1.12.		SIGNAL TO BE DEFINED (APPLICATION RESTRICTED TO PROCESS/UTILITIES FLOW DIAGRAMS)
4.1.13.		SUPPLY OR IMPULSE LINE (CONNECTION TO PROCESS)
4.1.14.		TUBING PIPING
4.1.15.		MECHANICAL LINK
4.1.16.		UNGUIDED ELECTROMAGNETIC OR ACOUSTIC SIGNAL

4.2. HARDWARE-BASED INSTRUMENTS

4.2.1.

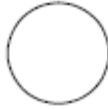

FIELD MOUNTED INSTRUMENT

4.2.2.

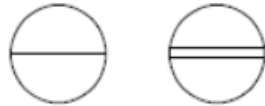

CENTRAL PANEL LOCAL PANEL

INSTRUMENT INSTALLED ON FRONT OF PANEL

4.2.3.

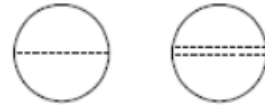

CENTRAL PANEL LOCAL PANEL

INSTRUMENT INSTALLED IN BACK OF PANEL

4.2.4.

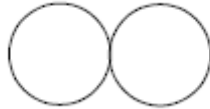

FIELD INSTRUMENTS OR FUNCTIONS SHARING A COMMON HOUSING

4.2.5.

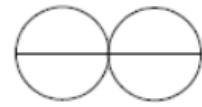

CENTRAL PANEL

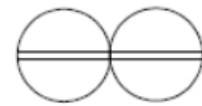

LOCAL PANEL

INSTRUMENTS OR FUNCTIONS SHARING A COMMON HOUSING INSTALLED ON FRONT OF PANEL

4.2.6.



CENTRAL PANEL

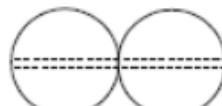

LOCAL PANEL

INSTRUMENTS OR FUNCTIONS SHARING A COMMON HOUSING INSTALLED IN BACK OF PANEL

4.2.7.

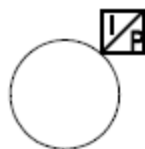

INSTRUMENT WITH I/P CONVERTER

4.3. SUPERVISORY SYSTEM OR FOUNDATION FIELDBUS FUNCTIONS

4.3.1.

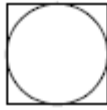

FIELD MOUNTED SUPERVISORY SYSTEM OR FF FUNCTION

4.3.2.



CENTRAL PANEL

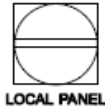

LOCAL PANEL

SUPERVISORY SYSTEM OR FF FUNCTION ACCESSIBLE TO OPERATOR (OR VISIBLE ON DISPLAY)

4.3.3.



CENTRAL PANEL

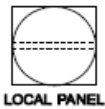

LOCAL PANEL

SUPERVISORY SYSTEM OR FF FUNCTION NOT ACCESSIBLE TO OPERATOR (OR NOT VISIBLE ON DISPLAY)

4.3.4. SUPERVISORY SYSTEM OR FOUNDATION FIELDBUS FUNCTIONS MODIFIERS

4.3.4.1.

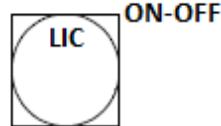

FIELD MOUNTED FOUNDATION FIELDBUS ON-OFF LEVEL CONTROLLER (WITH INDICATION)

4.4. COMPUTER FUNCTIONS

4.4.1.



FIELD MOUNTED COMPUTER FUNCTION

4.4.2.

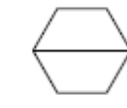

CENTRAL PANEL

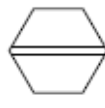

LOCAL PANEL

COMPUTER FUNCTION INSTALLED ON FRONT OF PANEL (OR VISIBLE ON DISPLAY)

4.4.3.



CENTRAL PANEL



LOCAL PANEL

COMPUTER FUNCTION INSTALLED IN BACK OF PANEL (OR NOT VISIBLE ON DISPLAY)

4.5. PLC FUNCTIONS

4.5.1.

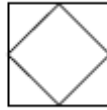

FIELD MOUNTED PLC FUNCTION

4.5.2.

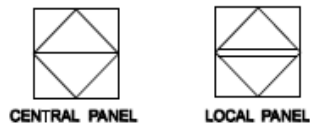

PLC FUNCTION ACCESSIBLE TO OPERATOR (OR VISIBLE ON DISPLAY)

4.5.3.

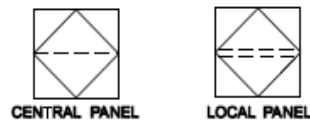

PLC FUNCTION NOT ACCESSIBLE TO OPERATOR (OR NOT VISIBLE ON DISPLAY)

4.5.4. PLC FUNCTIONS MODIFIERS

4.5.4.1.

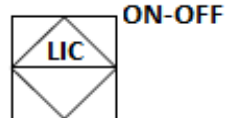

PLC ON-OFF LEVEL INDICATOR AND CONTROLLER ACCESSIBLE TO OPERATOR (VISIBLE ON DISPLAY)

4.6. INSTRUMENTED VALVES

This section shall be read in conjunction with section 0, which contains most on-off and control valves. For other instrumented valves, see symbols below.

4.6.1.

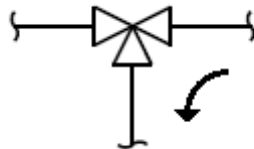

3-WAY VALVE

(ARROW INDICATES DE-ENERGIZED FLOW PATH)

4.6.2.

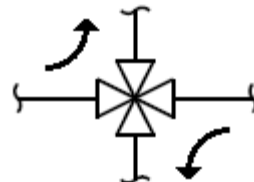

4-WAY VALVE

(ARROW INDICATES DE-ENERGIZED FLOW PATH)

4.6.3.

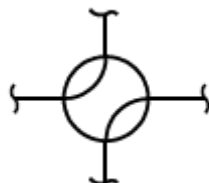

4-WAY VALVE

(USED FOR SWITCHING PNEUMATIC SIGNALS)

4.6.4.

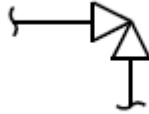

ANGULAR VALVE

4.6.5.



ANGLE CHECK GLOBE VALVE

4.6.6.

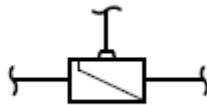

MINIMUM FLOW AUTOMATIC CONTROL VALVE

4.6.7.

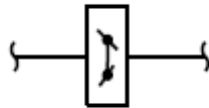

MODULATING DAMPER

4.6.8.



BUOY TYPE VALVE

4.6.9.



PUMP RECIRCULATION VALVE

4.7. ACTUATORS AND OPERATORS

4.7.1.



DIAPHRAGM OR DIAPHRAGM WITH POSITIONER

4.7.2.



BUOY TYPE

4.7.3.



PRESSURE BALANCED DIAPHRAGM

4.7.4.

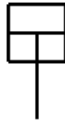

SINGLE OR DOUBLE ACTION CYLINDER

4.7.5.



SOLENOID

4.7.6.



ELECTRO-HYDRAULIC

4.7.7.



ROTARY MOTOR

4.7.8.



SPRING

4.7.9.



HANDWHEEL

4.7.10.



PILOT

4.7.11.



WEIGHT

4.7.12.



DOUBLE ACTION CYLINDER PARTIAL OPEN CLOSE

4.7.13.



HANDWHEEL DIAPHRAGM

4.7.14.



DIAPHRAGM SPRING-OPPOSED WITH OR WITHOUT PILOT

4.7.15.



INDIRECT TYPE POSITION TRANSMITTER

4.7.16.



INDIRECT TYPE POSITION LIMIT SWITCH

4.8. SELF-ACTUATED DEVICES

4.8.1.



SELF-OPERATED BACKPRESSURE GLOBE VALVE

4.8.2.

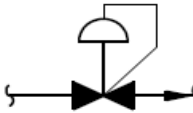

SELF-OPERATED PRESSURE REDUCING GLOBE VALVE

4.8.3.

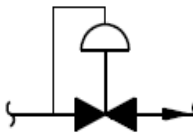

SELF-OPERATED BACKPRESSURE GLOBE VALVE WITH EXTERNAL PRESSURE TAP

4.8.4.

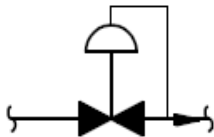

SELF-OPERATED PRESSURE REDUCING GLOBE VALVE WITH EXTERNAL PRESSURE TAP

4.8.5.

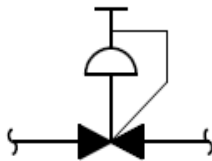

SELF-OPERATED PRESSURE REDUCING GLOBE VALVE WITH HANDWHEEL OPERATION

4.8.6.

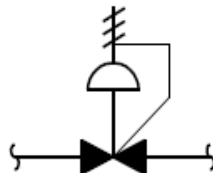

SELF-OPERATED PRESSURE REDUCING GLOBE VALVE WITH SPRING

4.8.7.



SELF-OPERATED DIFFERENTIAL PRESSURE REDUCING GLOBE VALVE WITH INTERNAL AND EXTERNAL PRESSURE TAPS

4.8.8.

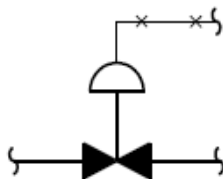

FILLED SYSTEM REGULATING GLOBE VALVE

4.8.9.







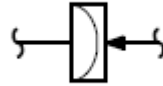

RUPTURE DISC OR BUCKLING PIN VALVE FOR PRESSURE RELIEF

4.8.10.

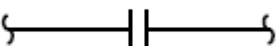
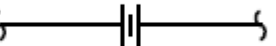
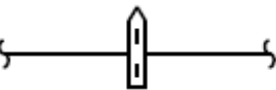

RUPTURE DISC OR BUCKLING PIN VALVE FOR VACUUM RELIEF

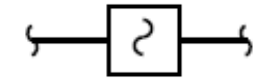
4.9. FLOW PRIMARY ELEMENTS

4.9.1.		FLOW REGULATING VALVE WITH INDICATION
4.9.2.		PRESSURE TAP TEST CONNECTIONS WITHOUT ORIFICE PLATE
4.9.3.		ORIFICE PLATE WITH VENA CONTRACTA TAPS
4.9.4.		DUAL CHAMBER ORIFICE FITTING
4.9.5.		SINGLE PORT PITOT TUBE/PITOT-VENTURI TUBE
4.9.6.		ROTAMETER TYPE FLOW INDICATOR
4.9.7.		INTEGRAL ORIFICE PLATE
4.9.8.		MAGNETIC FLOW SENSOR
4.9.9.		ULTRASONIC FLOW SENSOR
4.9.10.		VORTEX FLOW SENSOR

4.9.11.

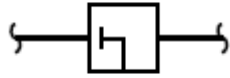

TARGET FLOW SENSOR

4.9.12.



VENTURI TUBE (NOZZLE)

4.9.13.



FLOW STRAIGHTENING VANE

4.9.14.



AVERAGING PITOT TUBE

4.9.15.



FLUME

4.9.16.



WEIR

4.9.17.

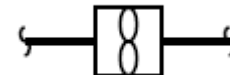

TURBINE

4.9.18.



POSITIVE DISPLACEMENT

4.9.19.



CORIOLIS

4.9.20.

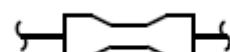

PARSHALL FLUMES

4.9.21.

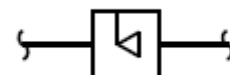

CONE METER

4.10. SEVERAL GENERAL REPRESENTATIONS

4.10.1.



LOCAL PILOT LIGHT

4.10.2.



CENTRAL PANEL PILOT LIGHT

4.10.3.



LOCAL PANEL PILOT LIGHT

4.10.4.



INTERLOCK OR FACILITY WHERE "X":

- P: PURGE OR FLUSHING DEVICE
- R: MANUAL OR REMOTE RESET FOR ACTUATOR
- I: GENERAL SYMBOL FOR LOGIC INTERLOCK
- AND: INTERLOCKING WITH "AND" FUNCTION
- OR: INTERLOCKING WITH "OR" FUNCTION
- T: INTERLOCKING WITH TIMER

4.10.5.



INTERLOCK CARRIED OUT BY PLC WHERE "X":

- I: GENERAL SYMBOL FOR LOGIC INTERLOCKING CARRIED OUT BY PROGRAMMABLE LOGIC CONTROLLER (PLC) OR PLC INPUTS/OUTPUTS
- T: INTERLOCKING WITH TIMER CARRIED OUT BY PLC
- AND: INTERLOCKING WITH "AND" FUNCTION CARRIED OUT BY PLC
- OR: INTERLOCKING WITH "OR" FUNCTION CARRIED OUT BY PLC
- PLC GENERAL INPUT/OUTPUT FOR ANALYZER (AY), FLOW (FY), LEVEL (LY), HARDWARE (HY), HUMIDITY (MY), PRESSURE (PY), TEMPERATURE (TY), POSITION (ZY), DIFFERENTIAL PRESSURE (PDY) AND DIFFERENTIAL TEMPERATURE (TDY)

4.10.6.



(ESD) WITH INDICATION OF ESD LEVEL (2, 3, 4, 3P, 3T)

4.10.7.



DIAPHRAGM SEAL

4.10.8.

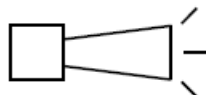

SOUND ALARM

4.10.9.

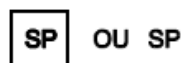

SET POINT

4.10.10.



SIGNAL INVERTER

4.11. ACCESSORIES

4.11.1.



FLAME ARRESTER

4.11.2.



ACCESS FITTING

4.12. SYMBOLS FOR EMERGENCY SHUT-DOWN DIAGRAMS

4.12.1.

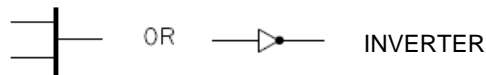

OR INVERTER

4.12.2.



AND TIME LAG

4.13. SIMPLIFIED SYMBOLOGY FOR INSTRUMENTATION IN PIPING AND INSTRUMENTATION DIAGRAMS (P&IDs)

The identification of primary flow elements may not be shown when they belong to the same loop.

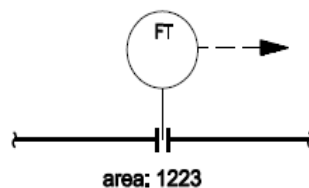

FE NEED NOT TO BE IDENTIFIED

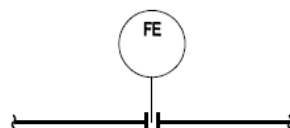
 TAG REFERÊNCIA TO OTHER DOCUMENTS:
FE-1223001

 FE IS IDENTIFIED, SINCE IT IS INSTALLED ON THE
LINE FOR FUTURE OR SPORADIC USE AND IS
NOT CONNECTED UP WITH ANY OTHER
INSTRUMENT

4.14. SYMBOLOGY FOR INSTRUMENTATION ON SAFETY PLANS

Symbology for Safety Plans shall be in accordance with IMO resolutions A.952 (23) and A.654 (16) and with ISO 17631.

4.15. MODELLING EXAMPLES FOR INSTRUMENTATION

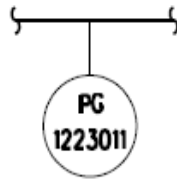
4.15.1.



MANOMETER (MECHANICAL)

4.15.2.

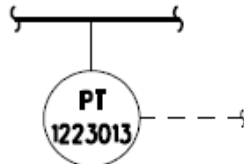

PRESSURE TRANSMITTER

4.15.3.

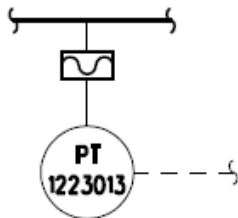

PRESSURE TRANSMITTER CONNECTED TO DIAPHRAGM SEAL WITH FILLED SYSTEM

4.15.4.

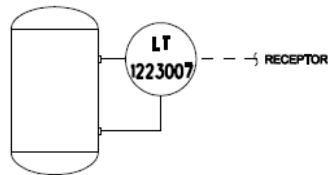

LEVEL TRANSMITTER, MOUNTED ON SIDE OF VESSEL WITH TWO CONNECTIONS

4.15.5.

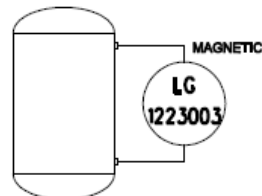

MAGNETIC LEVEL GAUGE EXTERNALLY CONNECTED

4.15.6.

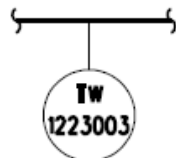

THERMOWELL

4.15.7.

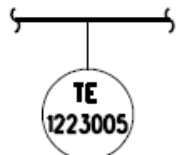

TEMPERATURE ELEMENT WITH OR WITHOUT WELL

4.15.8.

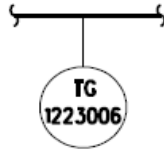

THERMOMETER (MECHANICAL)

4.15.9.

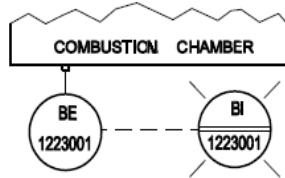

FLAME DETECTOR WITH ANALOG TYPE
FLAME INTENSITY INDICATOR

4.15.10.

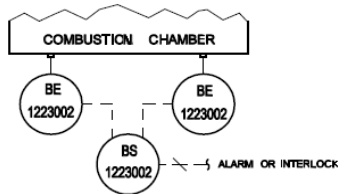

TWO FLAME DETECTORS CONNECTED TO COMMON
SWITCH

4.15.11.

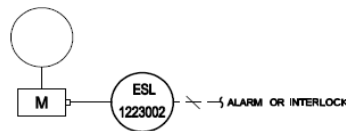

LOW VOLTAGE SWITCH CONNECTED TO PUMP MOTOR

4.15.12.

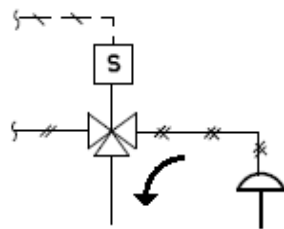

DIAPHRAGM ACTUATOR WITH SOLENOID VALVE
ELECTRICALLY COMMANDED WITHOUT POSITIONER

4.15.13.

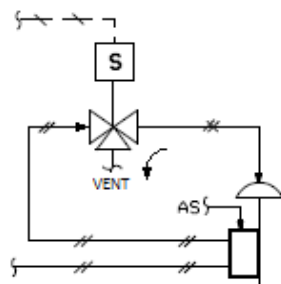

DIAPHRAGM ACTUATOR WITH SOLENOID VALVE
ELECTRICALLY COMMANDED WITH POSITIONER

4.15.14.

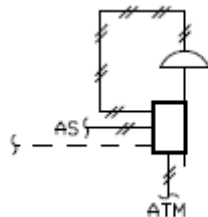

DIAPHRAGM ACTUATOR WITH ELECTRONIC POSITIONER
(4-20 mA)

4.15.15.

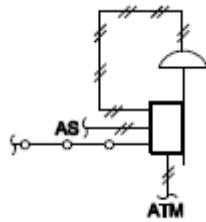

 DIAPHRAGM ACTUATOR WITH ELECTRONIC POSITIONER
 (FOUNDATION FIELDBUS)

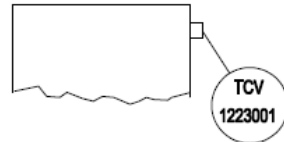
4.15.16.

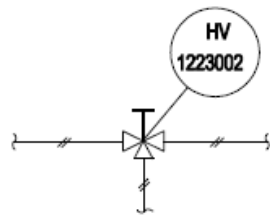

FUSIBLE PLUG

4.15.17.



SWITCHING VALVE IN PNEUMATIC SIGNAL LINE

4.15.18.

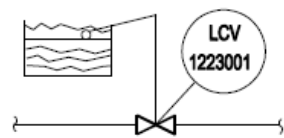

LEVEL REGULATOR WITH MECHANICAL LINKAGE

4.15.19.

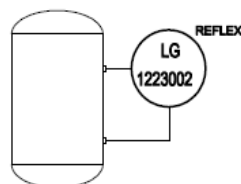

LEVEL GLASS INTEGRALLY MOUNTED ON VESSEL

4.15.20.

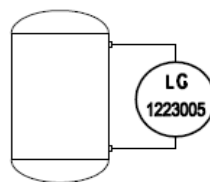
 LEVEL INDICATOR EXTERNALLY MOUNTED, TYPE:
 - MAGNETIC
 - FLOAT
 - THRUST DEVICE
 - OTHER MECHANICAL

4.15.21.

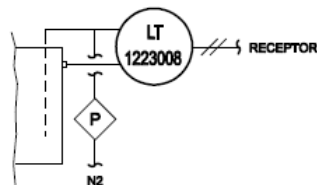
 LEVEL TRANSMITTER DIFFERENTIAL PRESSURE TYPE
 EXTERNALLY CONNECTED WITH DEEP TUBE

4.15.22.

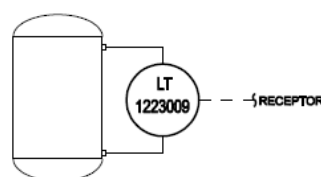

 LEVEL TRANSMITTER DIFFERENTIAL PRESSURE TYPE
 MOUNTED ON TANK

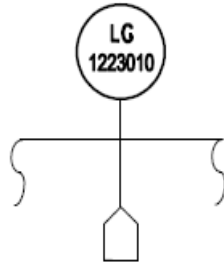
4.15.23.

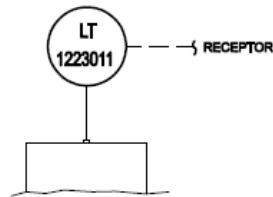

MECHANICAL LEVEL GAUGE, FLOAT TYPE

4.15.24.



CAPACITIVE TYPE LEVEL TRANSMITTER

4.15.25.

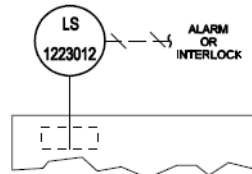

LEVEL SWITCH ROTARY TYPE TO MEASURE LEVEL OF SOLIDS

4.15.26.

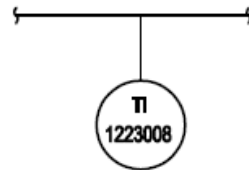

TEMPERATURE ELEMENT THERMO-COUPLE OR RESISTANCE BULB (RTD) CONNECTED TO A LOCAL TEMPERATURE INDICATOR – ELECTRONIC INDICATION

4.15.27.

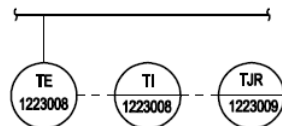

THERMOCOUPLE CONNECTED TO MULTIPOINT INDICATOR RECORDING ON MULTIPOINT SCANNING RECORDER

4.15.28.

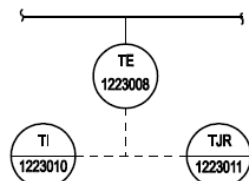

THERMOCOUPLE PARALLEL-WIRED TO MULTIPOINT INDICATOR AND MULTIPOINT SCANNING RECORDER

4.15.29.

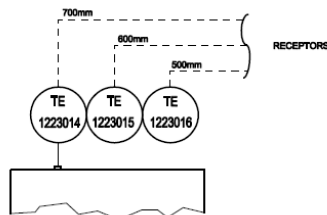

MULTI-ELEMENT THERMOCOUPLE FOR DIFFERENT ELEVATIONS

4.15.30.

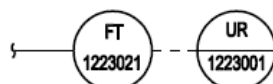

MULTI-VARIABLE RECORDER FOR TEMPORARY RECORDING (TREND RECORDER)

- | | | |
|----------|--|---|
| 4.15.31. | | <p>MULTI-POINT AND MULTI-VARIABLE LEVEL AND TEMPERATURE INDICATOR (TYPICAL EXAMPLE OF TANK TELEMETERING)</p> |
| 4.15.32. | | <p>TEMPERATURE GLOBE CONTROL VALVE, ACTUATED BY A TEMPERATURE CONTROLLER</p> |
| 4.15.33. | | <p>ORIFICE PLATE WITH FLANGE TAPS</p> |
| 4.15.34. | | <p>ORIFICE PLATE WITH FLANGE TAPS CONNECTED WITH ELECTRONIC FLOW INDICATOR (REPRESENTATION OF "FE" IS OPTIONAL)</p> |
| 4.15.35. | | <p>ORIFICE PLATE WITH FLANGE TAPS AND WITHOUT ORIFICE PLATE (FOR TEST CONNECTIONS)</p> |
| 4.15.36. | | <p>ORIFICE PLATE IN QUICK-CHANGE ORIFICE FITTING</p> |
| 4.15.37. | | <p>PITOT TUBE OR PITOT-VENTURI TUBE</p> |
| 4.15.38. | | <p>VENTURI TUBE OR NOZZLE</p> |

4.15.39.

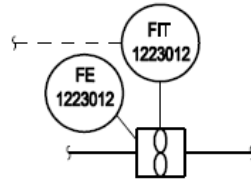

TURBINE TYPE PRIMARY ELEMENT WITH ANALOGICAL TRANSMISSION (4-20 mA)

4.15.40.

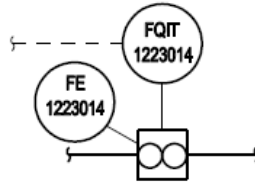

TOTALIZING POSITIVE DISPLACEMENT TYPE AND ANALOGICAL TRANSMISSION (4-20 mA)

4.15.41.

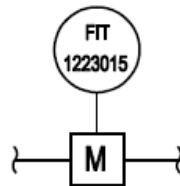

MAGNETIC FLOW TRANSMITTER

4.15.42.

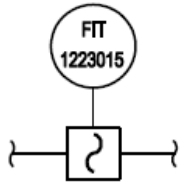

ULTRASONIC FLOW TRANSMITTER

4.15.43.

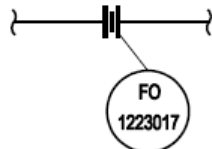

RESTRICTION ORIFICE

4.15.44.



FLOW SIGHT GLASS

4.15.45.

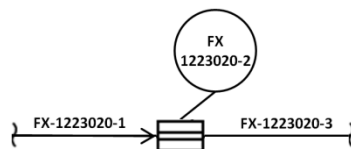

 FX-1223020-1: UPSTREAM STRAIGHT PIPE RUN
 FX-1223020-2: FLOW STRAIGHTENING VANE GAUGE
 FX-1223020-3: DOWNSTREAM STRAIGHT PIPE RUN

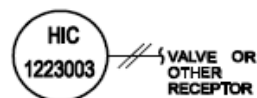
4.15.46.

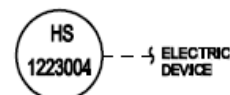

HAND (MANUAL) CONTROLLER - INDICATOR

4.15.47.



HAND (MANUAL) SWITCH

4.15.48.

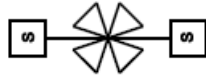

DOUBLE SOLENOID VALVE

4.15.49.

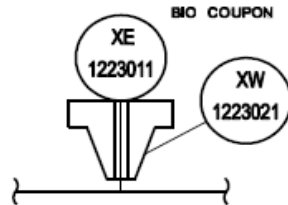

CORROSION COUPON
XE:
- BIOLOGIC (BIO) COUPON
- DISC COUPON
- STRIP COUPON
- SCALE COUPON

4.15.50.

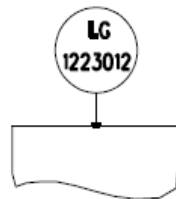

EXTERNAL MECHANICAL SCALE LEVEL INDICATOR

4.15.51.

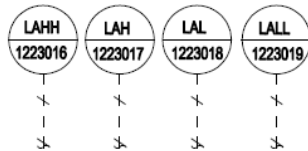

INDEPENDENT FIELD ABNORMAL LEVEL ALARMS:
- LAHH = VERY HIGH
- LAH = HIGH
- LAL = LOW
- LALL = VERY LOW

4.15.52.

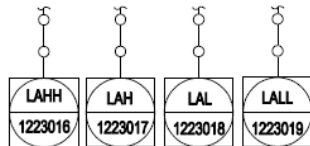

INDEPENDENT SUPERVISORY SYSTEM ABNORMAL LEVEL ALARMS

4.15.53.

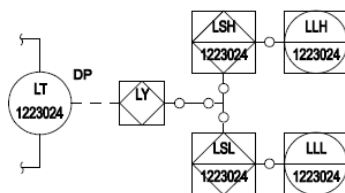

DIFFERENTIAL PRESSURE LEVEL TRANSMITTER
LOW AND HIGH LEVEL SWITCHES (PLC SYSTEM)
LOW AND HIGH LEVEL INDICATORS (SUPERVISORY SYSTEM)

4.15.54.

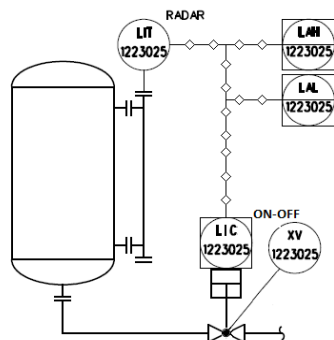

RADAR TYPE LEVEL TRANSMITTER FOUNDATION FIELDBUS (FF)
LOW AND HIGH ALARMS AT CENTRAL SUPERVISORY SYSTEM
VIRTUAL ON-OFF CONTROLLER IMPLEMENTED AT VALVE
BALL VALVE (XV)

4.15.55.

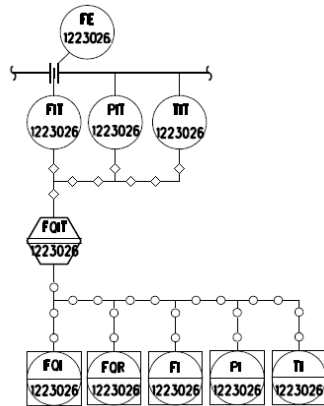

DIFFERENTIAL PRESSURE FLOWMETER FF
PRESSURE AND TEMPERATURE INDICATING TRANSMITTERS FF
FOUNDATION FIELDBUS FLOW COMPUTER MOUNTED ON A LOCAL PANEL
VOLUME INDICATION (FLOW TOTALIZED), VOLUME RECORD, FLOW INDICATION, PRESSURE INDICATION AND TEMPERATURE INDICATION AT CENTRAL SUPERVISORY SYSTEM

4.15.56.

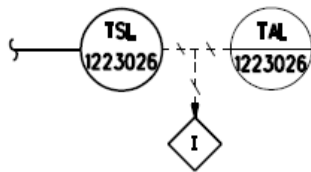

LOW TEMPERATURE SWITCH WITH ONE OUTPUT FOR ALARM AND TRIP

4.15.57.

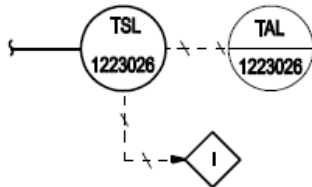

LOW TEMPERATURE SWITCH WITH TWO OUTPUTS FOR ALARM AND TRIP

4.15.58.

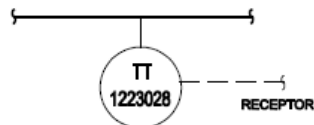

TEMPERATURE TRANSMITTER BY THERMOCOUPLE INPUT AND ELECTRIC OUTPUT

4.15.59.

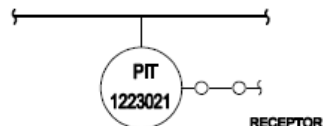

PRESSURE TRANSMITTER WITH FOUNDATION FIELDBUS

4.15.60.

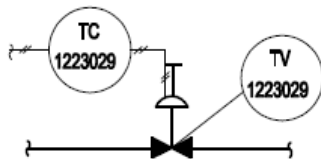

CONTROL GLOBE VALVE WITH TOP-MOUNTED HANDWHEEL

4.15.61.

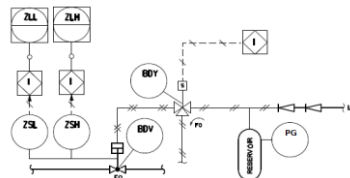

See note(s) 1 at the end of this section

4.15.62.

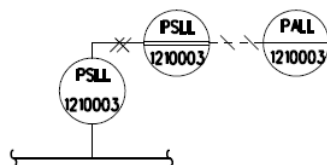

PNEUMATIC PRESSURE SWITCH ACTUATING ELECTRICAL PRESSURE SWITCH MOUNTED ON LOCAL RACK FOR OPERATING ALARM

4.15.63.

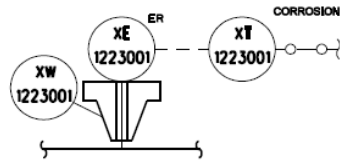

CORROSION TRANSMITTER FIELDBUS

 XE:
 - ER PROBE
 - LPR PROBE
 - GALVANIC PROBE

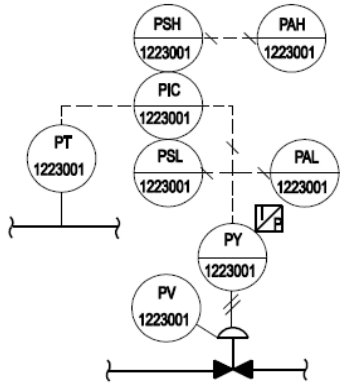
4.15.64.

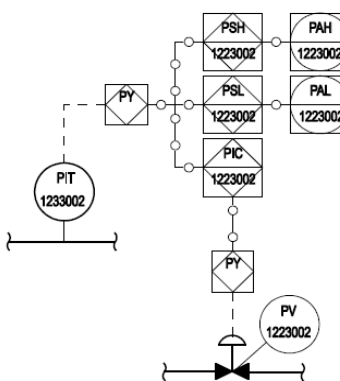

PRESSURE TRANSMITTER WITH ELECTRONIC OUTPUT SIGNAL CONTROLLER AND INDICATOR, CONTAINING HIGH AND LOW PRESSURE SWITCHES AND CONTROLLING PROCESS BY GLOBE CONTROL VALVE WITH ELECTROPNEUMATIC CONVERTER

4.15.65.

PRESSURE INDICATING TRANSMITTER WITH ELECTRONIC OUTPUT (4-20 mA)
VIRTUAL HIGH AND LOW PRESSURE SWITCHES IMPLEMENTED AT PLC
HIGH AND LOW ALARMS AT CENTRAL SUPERVISORY SYSTEM
PRESSURE INDICATING CONTROLLER AT PLC CONTROLLING A PRESSURE VALVE WITH AN ELECTRONIC POSITIONER

See note(s) 2 at the end of this section

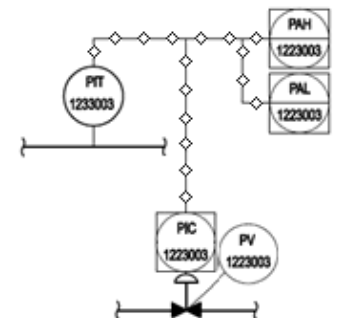
4.15.66.

PRESSURE INDICATING TRANSMITTER WITH ELECTRONIC OUTPUT (FOUNDATION FIELDBUS)
HIGH AND LOW ALARMS AT CENTRAL SUPERVISORY SYSTEM
PRESSURE INDICATING CONTROLLER IMPLEMENTED AT CONTROL VALVE FOUNDATION FIELDBUS

See note(s) 3 at the end of this section

NOTES:

(1) The process system and the sequential designation of SDV or BDV (i.e., the numeric part of the TAG) is shared by limit switch, position indicator, supervisory system video screen and solenoid valve. Blowdown valve fail open with single acting cylinder and solenoid valve commanded by electric signal and limit switch that signals on central panel.















(2) The use of electronic positioner is default for new projects. For detailed representation, see item 4.15.14.

(3) The use of electronic positioner is default for new projects. For detailed representation, see item 4.15.15.

5. ELECTRICAL

5.1. DIAGRAMS

5.1.1. POWER, CONTROL AND INTERLOCKING CONNECTIONS

5.1.1.1.		ELECTRICAL POWER CABLE OR LINE
5.1.1.2.		ELECTRICAL CONTROL OR DATA SIGNAL
5.1.1.3.		ELECTRICAL ACTUATION
5.1.1.4.		ELECTRICAL INTERLOCK
5.1.1.5.		MECHANICAL INTERLOCK
5.1.1.6.		ELECTRICAL CONNECTION (JUNCTION OF CONDUCTORS)
5.1.1.7.		UNCONNECTED CROSSING
5.1.1.8.		WITHDRAWABLE CONNECTION
5.1.1.9.		REMOVABLE LINK CONNECTION
5.1.1.10.		TERMINAL MUFFLE OR TERMINATION
5.1.1.11.		SPLICING MUFFLE OR STRAIGHT SPLICE
5.1.1.12.		SHUNT MUFFLE OR SHUNT STRAIGHT SPLICE
5.1.1.13.		EARTH CONNECTION
5.1.1.14.		FRAME (MASS) CONNECTION
5.1.1.15.		NEUTRAL CONNECTION OR SHORT

5.1.1.16.  OVERHEAD LINE

5.1.1.17.  SUBMARINE LINE

5.1.1.18.  TERMINAL BLOCK

5.1.1.19.  ELECTRICAL SWIVEL

5.1.2. MAGNETIC ELEMENTS, THERMAL ELEMENTS AND FUSES

5.1.2.1.  INSTANTANEOUS ELEMENT

5.1.2.2.  LONG TIME DELAY ELEMENT

5.1.2.3.  SHORT TIME DELAY ELEMENT

5.1.2.4.  THERMAL ELEMENT

5.1.2.5.  FUSE
See note(s) 1 at the end of this section

5.1.2.6.  SHORT-CIRCUIT LIMITER DEVICE

Notes:

(1) The rated fuse capacity in amperes shall be indicated alongside symbol.

5.1.3. CAPACITORS, LIGHTING ARRESTERS, SURGE DIVERTERS AND RESISTORS

5.1.3.1.  CAPACITOR
See note(s) 1 at the end of this section

5.1.3.2.



RESISTOR

See note(s) 2 at the end of this section

5.1.3.3.



HEATING RESISTOR

See note(s) 3 at the end of this section

5.1.3.4.

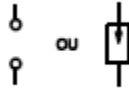

LIGHTNING ARRESTER OR SURGE DIVERTER

See note(s) 4 at the end of this section

5.1.3.5.

 TEMPERATURE DEPENDENT RESISTOR
 RESISTIVE THERMOMETER SENSOR
 RESISTANCE TEMPERATURE DETECTOR (RTD)

5.1.3.6.

 TEMPERATURE DEPENDENT RESISTOR
 RESISTIVE THERMOMETER SENSOR
 POSITIVE TEMPERATURE COEFFICIENT (PTC)

5.1.3.7.



RESISTOR WITH TAP CHANGER

See note(s) 2 at the end of this section

Notes:

- (1) It shall be indicated alongside symbol:
 - rated reactive capacity or capacitance;
 - rated voltage.
- (2) It shall be indicated alongside symbol:
 - resistance;
 - allowable time on (if earthing resistor);
 - initial current in amperes (if earthing resistor).
- (3) The rated capacity in watts shall be indicated alongside symbol.
- (4) The rated voltage shall be indicated alongside symbol.

5.1.4. BATTERIES, RECTIFIERS, INVERTERS, CONVERTERS AND FILTERS

5.1.4.1.



BATTERY

See note(s) 1 at the end of this section

5.1.4.2.



RECTIFIER OR BATTERY CHARGER

See note(s) 2 at the end of this section

5.1.4.3.



INVERTER

See note(s) 3 at the end of this section

5.1.4.4.



VARIABLE FREQUENCY CONVERTER

See note(s) 4 at the end of this section

5.1.4.5.



DC-DC CONVERTER

See note(s) 5 at the end of this section

5.1.4.6.



UNINTERRUPTABLE POWER SUPPLY (UPS)

See note(s) 3 at the end of this section

5.1.4.7.



STATIC SWITCH

See note(s) 6 at the end of this section

5.1.4.8.









HARMONIC FILTER

See note(s) 7 at the end of this section

Notes:

- (1) It shall be indicated alongside symbol:
 - rated voltage;
 - capacity Ah;
 - autonomy time in h.
- (2) It shall be indicated alongside symbol:
 - rated input voltage;
 - rated output voltage;
 - output capacity in amperes;
 - rated output power in kW.
- (3) It shall be indicated alongside symbol:
 - rated input voltage;
 - rated output power in kVA;
 - rated output voltage and number of phases;
 - output frequency.
- (4) It shall be indicated alongside symbol:
 - rated output power in kVA;
 - rated output voltage and number of phases;
 - output frequency range.
- (5) It shall be indicated alongside symbol:
 - rated input voltage;
 - rated output voltage;
 - rated output power in kW.
- (6) It shall be indicated alongside symbol:
 - rated power in kVA;
 - rated voltage and number of phases.
- (7) It shall be indicated alongside symbol:
 - rated voltage.

5.1.5. OPTICAL AND ACOUSTIC SIGNALING DEVICES





5.1.5.1.		SIGNALING LAMP See note(s) 1 at the end of this section
5.1.5.2.		BELL
5.1.5.3.		BUZZER
5.1.5.4.		SYREN
5.1.5.5.		HORN
5.1.5.6.		SIGNALING DEVICE WITH LED See note(s) 1 at the end of this section







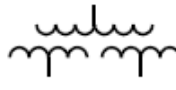

Notes:

(1) The colour shall be indicated alongside symbol according to:

- VD or G: green;
- VM or R: red;
- AM or Y: yellow;
- BR or W: white;
- AB or A: amber;
- AZ or B: blue.

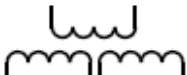
5.1.6. POWER TRANSFORMERS AND REACTORS

5.1.6.1.		TWO WINDINGS TRANSFORMER FOR ONE LINE DIAGRAM See note(s) 1 at the end of this section
5.1.6.2.		TWO WINDINGS TRANSFORMER WITH AUTOMATIC TAP CHANGER See note(s) 1 at the end of this section
5.1.6.3.		THREE WINDINGS TRANSFORMER FOR ONE LINE DIAGRAM See note(s) 2 at the end of this section
5.1.6.4.		SELF-TRANSFORMER FOR ONE-LINE DIAGRAM

5.1.6.5.		SINGLE PHASE TRANSFORMER FOR MULTI WIRE DIAGRAM See note(s) 1 at the end of this section
5.1.6.6.		SINGLE PHASE TRANSFORMER WITH TAP FOR MULTI WIRE DIAGRAM See note(s) 1 at the end of this section
5.1.6.7.		TWO WINDINGS TRANSFORMER FOR MULTIWIREDIAGRAM See note(s) 3 at the end of this section
5.1.6.8.		SINGLE PHASE TRANSFORMER WITH AUTOMATIC TAP CHANGER ON PRIMARY WINDING See note(s) 1 at the end of this section
5.1.6.9.		SINGLE PHASE OF THREE WINDINGS TRANSFORMER FOR MULTIWIREDIAGRAM See note(s) 2 at the end of this section
5.1.6.10.		SELF-TRANSFORMER FOR MULTI WIRE DIAGRAM
5.1.6.11.		REACTOR See note(s) 4 at the end of this section
5.1.6.12.		REACTOR WITH FERROMAGNETIC CORE See note(s) 4 at the end of this section

Notes:

- (1) It shall be indicated alongside symbol:
- identification number;
 - rated power;
 - primary and secondary rated voltages;
 - number of phases and frequency (if not 3ph or 60 Hz);
 - primary and secondary connection diagrams;
 - percentual impedance.
- (2) It shall be indicated alongside symbol:
- identification number;
 - rated power;
 - primary, secondary and tertiary rated voltages;
 - number of phases and frequency (if not 3ph or 60 Hz);
 - primary, secondary and tertiary connection diagrams;
 - percentual impedance.

(3) It shall be indicated alongside symbol:

- identification number;
- rated power;
- primary and secondary rated voltages;
- frequency (if not 60 Hz);
- percentual impedance.

(4) It shall be indicated alongside symbol:

- rated current in amperes;
- number of phases;
- percentual reactance X or inductance in mH;
- X/R ratio.

5.1.7. INSTRUMENT TRANSFORMERS

5.1.7.1.



COMMON TYPE (WOUND, BUSBAR, WINDOW, SPLIT CORE)
CURRENT TRANSFORMER FOR ONE LINE DIAGRAM

See note(s) 1 at the end of this section

5.1.7.2.



BUSHING CURRENT TRANSFORMER FOR ONE LINE
DIAGRAM

See note(s) 1 at the end of this section

5.1.7.3.



WINDOW TYPE CURRENT TRANSFORMER (INVOLVING THE
THREE PHASES) FOR SINGLE LINE DIAGRAM

See note(s) 2 at the end of this section

5.1.7.4.



COMMON TYPE (WOUND, BUSBAR, WINDOW, SPLIT CORE)
CURRENT TRANSFORMER FOR MULTI LINE DIAGRAM

See note(s) 2 at the end of this section

5.1.7.5.



BUSHING TYPE CURRENT TRANSFORMER FOR MULTI LINE
DIAGRAM

See note(s) 2 at the end of this section

5.1.7.6.



WINDOW TYPE CURRENT TRANSFORMER (INVOLVING THE
THREE PHASES) FOR MULTI LINE DIAGRAM

See note(s) 2 at the end of this section

5.1.7.7.



VOLTAGE TRANSFORMER FOR ONE LINE DIAGRAM

See note(s) 2 at the end of this section

5.1.7.8.







VOLTAGE TRANSFORMER FOR MULTI LINE DIAGRAM

See note(s) 3 at the end of this section

Notes:

- (1) It shall be indicated alongside symbol:
- current ratio;
 - number of transformers;
 - connection diagram.
- (2) The voltage ratio shall be indicated alongside symbol.
- (3) It shall be indicated alongside symbol:
- voltage ratio;
 - number of transformers;
 - connection diagram.

5.1.8. CONNECTION DIAGRAMS

5.1.8.1.		THREE PHASES, THREE WIRES, DELTA (OR TRIANGLE) UNGROUNDED
5.1.8.2.		THREE PHASES, THREE WIRES, DELTA (OR TRIANGLE) GROUNDED
5.1.8.3.		THREE PHASES, THREE OR FOUR WIRES, STAR OR WYE UNGROUNDED
5.1.8.4.		THREE PHASES, THREE OR FOUR WIRES, STAR OR WYE SOLIDLY GROUNDED
5.1.8.5.		THREE PHASES, THREE OR FOUR WIRES, STAR OR WYE RESISTANCE GROUNDED
5.1.8.6.		THREE PHASES, THREE OR FOUR WIRES, STAR OR WYE RESISTANCE GROUNDED VIA TRANSFORMER
5.1.8.7.		THREE PHASES, THREE OR FOUR WIRES, ZIGZAG UNGROUNDED
5.1.8.8.		THREE PHASES, THREE OR FOUR WIRES, ZIGZAG RESISTANCE GROUNDED
5.1.8.9.		THREE PHASES, THREE OR FOUR WIRES, ZIGZAG RESISTANCE GROUNDED VIA TRANSFORMER
5.1.8.10.		THREE PHASES, THREE WIRES, V CONNECTION (OPEN DELTA)
5.1.8.11.		THREE PHASES, THREE WIRES, V CONNECTION (OPEN DELTA) GROUNDED

5.1.9. SWITCHING DEVICES

5.1.9.1.



SINGLE THROW DISCONNECTING SWITCH FOR ONE LINE DIAGRAM

See note(s) 1 at the end of this section

5.1.9.2.



DOUBLE THROW DISCONNECTING SWITCH FOR ONE LINE DIAGRAM

See note(s) 1 at the end of this section

5.1.9.3.



DUAL LATERAL OPENING DISCONNECTING SWITCH FOR ONE LINE DIAGRAM

See note(s) 1 at the end of this section

5.1.9.4.



FUSE SWITCH FOR ONE LINE DIAGRAM

See note(s) 2 at the end of this section

5.1.9.5.



SINGLE THROW DISCONNECTING SWITCH WITH CASING FOR ONE-LINE DIAGRAM

See note(s) 1 at the end of this section

5.1.9.6.



LOW-VOLTAGE MOULDED CASE CIRCUIT-BREAKER FOR ONE LINE DIAGRAM

See note(s) 3 at the end of this section

5.1.9.7.



LOW-VOLTAGE AIR CIRCUIT-BREAKER (POWER CIRCUIT-BREAKER) FOR ONE LINE DIAGRAM

See note(s) 3 at the end of this section

5.1.9.8.



MEDIUM VOLTAGE CIRCUIT-BREAKER

See note(s) 3 at the end of this section

5.1.9.9.

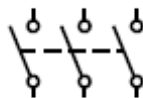

SINGLE THROW DISCONNECTING SWITCH FOR THREE-LINE DIAGRAM

See note(s) 1 at the end of this section

5.1.9.10.

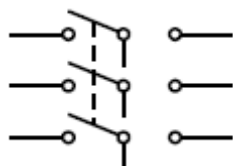

DOUBLE THROW DISCONNECTING SWITCH FOR THREE-LINE DIAGRAM

See note(s) 1 at the end of this section

5.1.9.11.

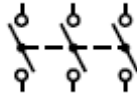

DUAL LATERAL OPENING DISCONNECTING SWITCH FOR THREE-LINE DIAGRAM

See note(s) 1 at the end of this section

5.1.9.12.



FUSE SWITCH FOR THREE-LINE DIAGRAM

See note(s) 2 at the end of this section

5.1.9.13.

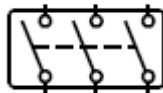

SINGLE THROW DISCONNECTING SWITCH WITH CASING FOR THREE-LINE DIAGRAM

See note(s) 1 at the end of this section

5.1.9.14.

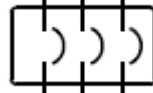

LOW VOLTAGE MOULDED CASE CIRCUIT-BREAKER FOR THREE-LINE DIAGRAM

See note(s) 3 at the end of this section

5.1.9.15.

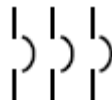

LOW VOLTAGE AIR CIRCUIT FOR THREE-LINE DIAGRAM

See note(s) 3 at the end of this section

5.1.9.16.



MEDIUM VOLTAGE CIRCUIT-BREAKER FOR THREE-LINE DIAGRAM

See note(s) 3 at the end of this section

5.1.9.17.



LOW VOLTAGE SINGLE POLE MINIATURE CIRCUIT-BREAKER

See note(s) 1 at the end of this section

5.1.9.18.

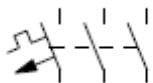

LOW VOLTAGE THREE POLES MINIATURE CIRCUIT-BREAKER

See note(s) 1 at the end of this section

Notes:

- (1) It shall be indicated alongside symbol:
 - identification number (optional);
 - rated capacity in amperes.
- (2) It shall be indicated alongside symbol:
 - identification number (optional);
 - rated fuse capacity in amperes.
- (3) It shall be indicated alongside symbol:
 - identification number (optional);
 - rated capacity in amperes (frame size);
 - rated capacity and adjustment of actuator;
 - short-circuit breaking and making capacities (optional);
 - STD, LDT and INST annotation according to item 5.1.2;
 - LIM annotation for short-circuit limiting devices.

(4) It shall be indicated alongside symbol:

- identification number (optional);
- rated capacity in amperes (frame size);
- short-circuit breaking capacity (optional);
- short-circuit making capacity (optional).

(5) the rated capacity in amperes shall be indicated alongside symbol.

5.1.10. SELECTOR AND TRANSFER SWITCHES

5.1.10.1.



SELECTOR SWITCH

5.1.10.2.



INSTRUMENT TRANSFER SWITCH

5.1.10.3.

CONTACTS	INDICATION OF POSITION		
	A	B	
1-2			X
3-4	X	X	
5-6			X
7-8	X		

X - CLOSED CONTACTS

MULTIDIRECTIONAL SELECTOR OR TRANSFER SWITCH WITH INDEPENDENT CONTACTS

ONLY CONTACTS ARE DEPICTED ON DIAGRAM AND RESPECTIVE SEQUENCE TABLE TO BE ADDED
E.G.: 4-CONTACT 3 POSITION SWITCH

5.1.11. ELECTRICAL CONTACTS

5.1.11.1.

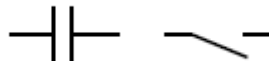

MAKE CONTACT – NORMALLY OPEN (N.O)

See note(s) 1 and 2 at the end of this section

5.1.11.2.

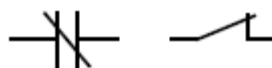

BREAK CONTACT – NORMALLY CLOSED (N.C)

See note(s) 1 and 2 at the end of this section

5.1.11.3.

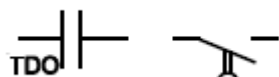

MAKE CONTACT - (N.O) DELAYED OPENING

See note(s) 1 and 2 at the end of this section

5.1.11.4.

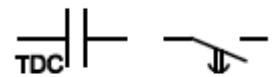

MAKE CONTACT - (N.O) DELAYED CLOSING

See note(s) 1 and 2 at the end of this section

5.1.11.5.

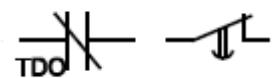

BREAK CONTACT - (N.C) DELAYED OPENING

See note(s) 1 and 2 at the end of this section

5.1.11.6.

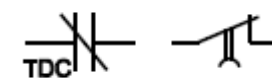

BREAK CONTACT - (N.C) DELAYED CLOSING

See note(s) 1 and 2 at the end of this section

5.1.11.7.

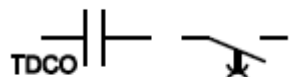

MAKE CONTACT - (N.O) DELAYED

See note(s) 1 and 2 at the end of this section

5.1.11.8.

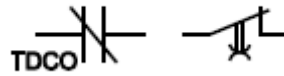

BREAK CONTACT - (N.C) DELAYED

See note(s) 1 and 2 at the end of this section

5.1.11.9.



MAKE CONTACT – NORMALLY OPEN (N.O) - ACTUATED BY FLOW (FLOW SWITCH)

See note(s) 1 and 2 at the end of this section

5.1.11.10.



BREAK CONTACT – NORMALLY CLOSED (N.C) -ACTUATED BY FLOW (FLOW SWITCH)

See note(s) 1 and 2 at the end of this section

5.1.11.11.



CHAVE DE ESTABELECIMENTO – NORMALLY OPEN (N.O) - POSITION SWITCH – LIMIT SWITCH

See note(s) 1 and 2 at the end of this section

5.1.11.12.



BREAK CONTACT – NORMALLY CLOSED (N.C) - POSITION SWITCH – LIMIT SWITCH

See note(s) 1 and 2 at the end of this section

5.1.11.13.

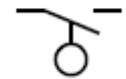

MAKE CONTACT – NORMALLY OPEN (N.O) - ACTUATED BY REFERENCE LEVEL (LEVEL SWITCH)

See note(s) 1 and 2 at the end of this section

5.1.11.14.

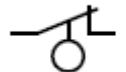

BREAK CONTACT – NORMALLY CLOSED (N.C) - ACTUATED BY REFERENCE LEVEL (LEVEL SWITCH)

See note(s) 1 and 2 at the end of this section

5.1.11.15.



MAKE CONTACT – NORMALLY OPEN (N.O) - ACTUATED BY REFERENCE IN PRESSURE

See note(s) 1 and 2 at the end of this section

5.1.11.16.

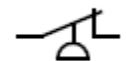

BREAK CONTACT – NORMALLY CLOSED (N.C) - ACTUATED BY REFERENCE IN PRESSURE

See note(s) 1 and 2 at the end of this section

5.1.11.17.



MAKE CONTACT – NORMALLY OPEN (N.O) - ACTUATED BY REFERENCE IN TEMPERATURE

See note(s) 1 and 2 at the end of this section

5.1.11.18.



BREAK CONTACT – NORMALLY CLOSED (N.C) - ACTUATED BY REFERENCE IN TEMPERATURE

See note(s) 1 and 2 at the end of this section

5.1.11.19.



TEMPERATURE SENSITIVE SWITCH – THERMOSTAT – MAKE CONTACT – NORMALLY OPEN (N.O)

See note(s) 1 and 2 at the end of this section

5.1.11.20.



TEMPERATURE SENSITIVE SWITCH – THERMOSTAT – BREAK CONTACT – NORMALLY CLOSED (N.C)

See note(s) 1 and 2 at the end of this section

Notes:

(1) The designations N.O. or N.C. indicate the position of contact when controlling device is not energized or not operated (as when on shelf). Actuating device may be of any kind and a note may be required alongside the symbol to clarify the exact point at which the contact commutates. For example, the point at which contact opens or closes as function of pressure, level, flow, voltage, current, temperature, etc.

(2) The identification number shall be indicated alongside symbol.

5.1.12. PUSH-BUTTON SWITCHES

PUSH-BUTTON FOR ONE-LINE DIAGRAM

5.1.12.1.



X ACCORDING TO:

L – TURNS ON
 D – TURNS OFF
 O – OPEN
 C – CLOSE
 N – NEUTRAL
 F – TURNS FORWARD (FORWARD)
 R – TURNS BACKWARD (REVERSE)

5.1.12.2.

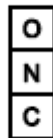

E.G. PUSH-BUTTON SWITCH: OPEN/NEUTRAL/CLOSE

5.1.12.3.

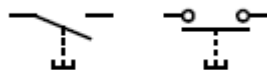

SWITCH MANUALLY OPERATED, PUSH-BUTTON (N.O) WITH AUTOMATIC RETURN (MOMENTARY CLOSING) FOR MULTI-LINE DIAGRAM

5.1.12.4.

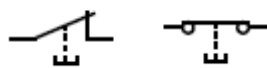

SWITCH MANUALLY OPERATED, PUSH-BUTTON (N.C) WITH AUTOMATIC RETURN (MOMENTARY OPENING) FOR MULTI-LINE DIAGRAM

5.1.12.5.

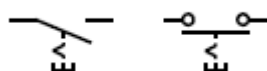

SWITCH MANUALLY OPERATED, PUSH-BUTTON (N.O) WITH RETENTION FOR MULTI-LINE DIAGRAM

5.1.12.6.

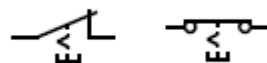

SWITCH MANUALLY OPERATED, PUSH-BUTTON (N.C) WITH RETENTION FOR MULTI-LINE DIAGRAM

5.1.12.7.

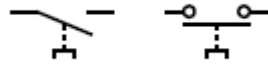

SWITCH MANUALLY OPERATED, PULLING-BUTTON (N.O) WITH AUTOMATIC RETURN (MOMENTARY CLOSING) FOR MULTI-LINE DIAGRAM

5.1.12.8.

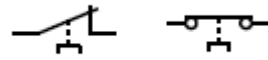

SWITCH MANUALLY OPERATED, PULLING-BUTTON (N.C) WITH AUTOMATIC RETURN (MOMENTARY OPENING) FOR MULTI-LINE DIAGRAM

5.1.12.9.

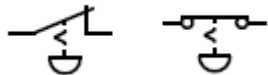

SWITCH MANUALLY OPERATED, EMERGENCY PUSH-BUTTON EMERGENCY STOP WITH RETENTION

5.1.12.10.

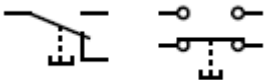

SWITCH MANUALLY OPERATED, CHANGE-OVER, BREAK BEFORE MAKE CONTACT, AUTOMATIC RETURN

5.1.13. ROTATING ELECTRICAL MACHINES

5.1.13.1.

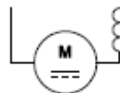
 SERIES DC MOTOR
See note(s) 1 at the end of this section

5.1.13.2.

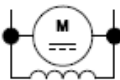
 SHUNT DC MOTOR
See note(s) 1 at the end of this section

5.1.13.3.

 SINGLE PHASE INDUCTION MOTOR
See note(s) 1 at the end of this section

5.1.13.4.

 SINGLE PHASE SYNCHRONOUS MOTOR
See note(s) 1 at the end of this section

5.1.13.5.

 THREE PHASE INDUCTION MOTOR
See note(s) 1 at the end of this section

5.1.13.6.

 THREE PHASE SYNCHRONOUS MOTOR
See note(s) 1 at the end of this section

5.1.13.7.

 THREE PHASE INDUCTION MOTOR WITH HEATING RESISTOR
See note(s) 1 at the end of this section

5.1.13.8.

 THREE PHASE SYNCHRONOUS GENERATOR
See note(s) 2 at the end of this section

5.1.13.9.



THREE PHASE SYNCHRONOUS GENERATOR WITH HEATING RESISTOR

See note(s) 2 at the end of this section

5.1.13.10.



THREE PHASE ASYNCHRONOUS GENERATOR

See note(s) 3 at the end of this section

5.1.13.11.



THREE PHASE ASYNCHRONOUS GENERATOR WITH HEATING RESISTOR

See note(s) 3 at the end of this section

Notes:

- (1) It shall be indicated alongside symbol:
 - identification number;
 - rated power in kW.
- (2) It shall be indicated alongside symbol:
 - rated power in kW or kVA and power factor;
 - transient and subtransient reactances;
 - rated frequency;
 - rated voltage;
 - connection diagram;
 - synchronous speed or number of poles.
- (3) It shall be indicated alongside symbol:
 - rated power in kW;
 - transient reactance;
 - rated frequency;
 - rated voltage;
 - connection diagram;
 - rated speed or number of poles.

5.1.14. MOTOR STARTERS

5.1.14.1.



STARTER, GENERAL SYMBOL

See note(s) 1 at the end of this section

5.1.14.2.



DIRECT ON-LINE STARTER, REVERSING

See note(s) 1 at the end of this section

5.1.14.3.



STAR-DELTA STARTING

See note(s) 1 at the end of this section

5.1.14.4.



STARTER WITH SELF-TRANSFORMER

See note(s) 1 at the end of this section

5.1.14.5.



ELECTRONIC STARTER (SOFT-STARTER)

See note(s) 1 at the end of this section

Notes:

(1) A typical detailed drawing indicating all components shall be attached.

5.1.15. INSTRUMENTS

5.1.15.1.



GENERAL SYMBOL

See note(s) 1 at the end of this section

5.1.15.2.



RECORDING INSTRUMENT

See note(s) 1 at the end of this section

5.1.15.3.



TOTALIZING INSTRUMENT

See note(s) 2 at the end of this section

5.1.15.4.

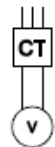

VOLTIMETER WITH TRANSFER SWITCH FOR THREE-LINE DIAGRAM

5.1.15.5.

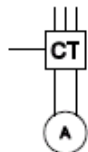

AMMETER WITH TRANSFER SWITCH FOR THREE-LINE DIAGRAM

5.1.15.6.

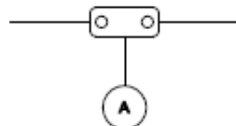

DC AMMETER WITH SHUNT

5.1.15.7.

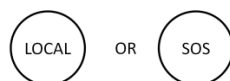

REMOTE INDICATION

SOS: OPERATION AND SUPERVISION AT CENTRAL SUPERVISORY SYSTEM STATION

LOCAL: LOCAL SUPERVISION AND CONTROL STATION

5.1.15.8.



TRANSDUCER

See note(s) 1 and 3 at the end of this section

Notes:

(1) X according to:

- V (voltmeter);
- A (ammeter);
- W (wattmeter);
- var (varmeter);
- COS \varnothing (power factor);
- \varnothing (phasemeter);
- Hz (frequency meter);
- SYN (synchronoscope);
- t^o (thermometer/pyrometer);
- rpm (tachometer).

(2) X according to:

- h (hour totalizer);
- Ah (ampere hour totalizer);
- Wh (watt hour totalizer);
- Wh d (watt hour totalizer with maximum demand indicator);
- varh (var hour totalizer).

(3) The output signal shall be indicated alongside symbol.

5.1.16. COILS

5.1.16.1.

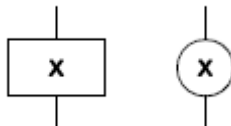

RELAY OR CONTACTOR COIL (GENERAL SYMBOL)
X: IDENTIFICATION NUMBER

5.1.16.2.

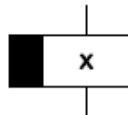

COIL OF SLOW-RELEASING RELAY
X: IDENTIFICATION NUMBER

5.1.16.3.

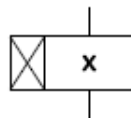

COIL OF SLOW-OPERATING RELAY
X: IDENTIFICATION NUMBER

5.1.16.4.

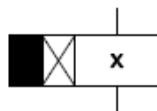

COIL OF SLOW-OPERATING AND SLOW-RELEASING RELAY
X: IDENTIFICATION NUMBER

5.1.16.5.

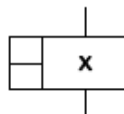

COIL OF HIGH SPEED RELAY
X: IDENTIFICATION NUMBER

5.1.17. MISCELLANEOUS

5.1.17.1.

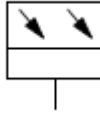

SOLAR GENERATION STATION

See note(s) 1 at the end of this section

5.1.17.2.

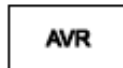
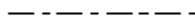

 PHOTO-SWITCH – PHOTOCELL RELAY
SWITCH ACTUATED BY LIGHT

5.1.17.3.



AUTOMATIC VOLTAGE REGULATOR

5.1.17.4.



EQUIPMENT BOUNDARY

5.1.17.5.

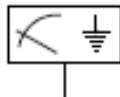

 LOW ISOLATION TO GROUND DETECTOR DEVICE
EFI: EARTH FAULT INDICATOR

5.1.17.6.

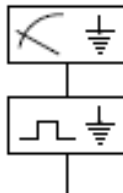

GROUND INSULATION MONITORING DEVICE

5.1.17.7.

 GROUND INSULATION MONITORING DEVICE WITH
INSULATION FAULT TESTE DEVICE

5.1.17.8.



PROTECTION RELAY

See note(s) 2 for X at the end of this section

5.1.17.9.

PROTEC.	X, X, X ...
COMMUN.	X, X, X ...
METER	Y, Y, Y ...

MULTIFUNCTION PROTECTION RELAY

See note(s) 4 for X and 2 for Y at the end of this section

5.1.17.10.

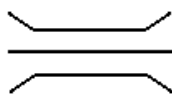

BUSBAR TRUNKING (BUS DUCT)

See note(s) 3 at the end of this section

5.1.17.11.



JUNCTION BOX

Notes:

- (1) It shall be indicated alongside symbol:
- rated voltage in volts;
 - rated power in watts.
- (2) According to IEEE STD C-37.2 functions.
- (3) It shall be indicated alongside symbol:
- rated current in amperes.
- (4) According to:
- V (voltmeter);
 - A (ammeter);
 - W (wattmeter);
 - var (varmeter);
 - COS Ø (power factor);
 - Ø (phasemeter);
 - Hz (frequency meter);
 - SYN (synchronouscope);
 - t^o (thermometer/pyrometer);
 - rpm (tachometer).

5.2. INSTALLATION
5.2.1. LIGHTING AND POWER

5.2.1.1.

 LED OR FLUORESCENT LAMP LIGHTING FIXTURE 2X60cm
 NORMAL CIRCUIT, PENDANT INSTALLATION
 NOT CERTIFIED FOR HAZARDOUS AREA

5.2.1.2.

 LED OR FLUORESCENT LAMP LIGHTING FIXTURE 2X60cm
 ESSENTIAL CIRCUIT, PENDANT INSTALLATION
 NOT CERTIFIED FOR HAZARDOUS AREA

5.2.1.3.

 LED OR FLUORESCENT LAMP LIGHTING FIXTURE 2X60cm
 EMERGENCY CIRCUIT, PENDANT INSTALLATION
 NOT CERTIFIED FOR HAZARDOUS AREA

5.2.1.4.





 LED OR FLUORESCENT LAMP LIGHTING FIXTURE 2X60cm
 NORMAL CIRCUIT, LONGITUDINAL INSTALLATION IN
 BULKHEAD
 NOT CERTIFIED FOR HAZARDOUS AREA

5.2.1.5.

 LED OR FLUORESCENT LAMP LIGHTING FIXTURE 2X60cm
 ESSENTIAL CIRCUIT, LONGITUDINAL INSTALLATION IN
 BULKHEAD
 NOT CERTIFIED FOR HAZARDOUS AREA

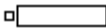
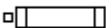
5.2.1.6.

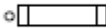
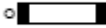
 LED OR FLUORESCENT LAMP LIGHTING FIXTURE 2X60cm
 EMERGENCY CIRCUIT, LONGITUDINAL INSTALLATION IN
 BULKHEAD
 NOT CERTIFIED FOR HAZARDOUS AREA

5.2.1.7.		LED OR FLUORESCENT LAMP LIGHTING FIXTURE 2X60cm NORMAL CIRCUIT, TRANSVERSAL INSTALLATION IN COLUMN OR BULKHEAD NOT CERTIFIED FOR HAZARDOUS AREA
5.2.1.8.		LED OR FLUORESCENT LAMP LIGHTING FIXTURE 2X60cm ESSENTIAL CIRCUIT, TRANSVERSAL INSTALLATION IN COLUMN OR BULKHEAD NOT CERTIFIED FOR HAZARDOUS AREA
5.2.1.9.		LED OR FLUORESCENT LAMP LIGHTING FIXTURE 2X60cm EMERGENCY CIRCUIT, TRANSVERSAL INSTALLATION IN COLUMN OR BULKHEAD NOT CERTIFIED FOR HAZARDOUS AREA
5.2.1.10.		LED OR FLUORESCENT LAMP LIGHTING FIXTURE 2X60cm NORMAL CIRCUIT, POLE INSTALLATION NOT CERTIFIED FOR HAZARDOUS AREA
5.2.1.11.		LED OR FLUORESCENT LAMP LIGHTING FIXTURE 2X60cm ESSENTIAL CIRCUIT, POLE INSTALLATION NOT CERTIFIED FOR HAZARDOUS AREA
5.2.1.12.		LED OR FLUORESCENT LAMP LIGHTING FIXTURE 2X60cm EMERGENCY CIRCUIT, POLE INSTALLATION NOT CERTIFIED FOR HAZARDOUS AREA
5.2.1.13.		LED OR FLUORESCENT LAMP LIGHTING FIXTURE 2X60cm NORMAL CIRCUIT, FALSE CEILING INSTALLATION NOT CERTIFIED FOR HAZARDOUS AREA
5.2.1.14.		LED OR FLUORESCENT LAMP LIGHTING FIXTURE 2X60cm ESSENTIAL CIRCUIT, FALSE CEILING INSTALLATION NOT CERTIFIED FOR HAZARDOUS AREA
5.2.1.15.		LED OR FLUORESCENT LAMP LIGHTING FIXTURE 2X60cm EMERGENCY CIRCUIT, FALSE CEILING INSTALLATION NOT CERTIFIED FOR HAZARDOUS AREA
5.2.1.16.		LED OR FLUORESCENT LAMP LIGHTING FIXTURE 2X15/20cm NORMAL CIRCUIT, PENDANT INSTALLATION NOT CERTIFIED FOR HAZARDOUS AREA
5.2.1.17.		LED OR FLUORESCENT LAMP LIGHTING FIXTURE 2X15/20cm ESSENTIAL CIRCUIT, PENDANT INSTALLATION NOT CERTIFIED FOR HAZARDOUS AREA
5.2.1.18.		LED OR FLUORESCENT LAMP LIGHTING FIXTURE 2X15/20cm EMERGENCY CIRCUIT, PENDANT INSTALLATION NOT CERTIFIED FOR HAZARDOUS AREA

5.2.1.19.



LED OR FLUORESCENT LAMP LIGHTING FIXTURE 2X15/20cm
NORMAL CIRCUIT, LONGITUDINAL INSTALLATION IN
BULKHEAD
NOT CERTIFIED FOR HAZARDOUS AREA

5.2.1.20.



LED OR FLUORESCENT LAMP LIGHTING FIXTURE 2X15/20cm
ESSENTIAL CIRCUIT, LONGITUDINAL INSTALLATION IN
BULKHEAD
NOT CERTIFIED FOR HAZARDOUS AREA

5.2.1.21.



LED OR FLUORESCENT LAMP LIGHTING FIXTURE 2X15/20cm
EMERGENCY CIRCUIT, LONGITUDINAL INSTALLATION IN
BULKHEAD
NOT CERTIFIED FOR HAZARDOUS AREA

5.2.1.22.



LED OR FLUORESCENT LAMP LIGHTING FIXTURE 2X15/20cm
NORMAL CIRCUIT, TRANSVERSAL INSTALLATION IN
COLUMN OR BULKHEAD
NOT CERTIFIED FOR HAZARDOUS AREA

5.2.1.23.



LED OR FLUORESCENT LAMP LIGHTING FIXTURE 2X15/20cm
ESSENTIAL CIRCUIT, TRANSVERSAL INSTALLATION IN
COLUMN OR BULKHEAD
NOT CERTIFIED FOR HAZARDOUS AREA

5.2.1.24.



LED OR FLUORESCENT LAMP LIGHTING FIXTURE 2X15/20cm
EMERGENCY CIRCUIT, TRANSVERSAL INSTALLATION IN
COLUMN OR BULKHEAD
NOT CERTIFIED FOR HAZARDOUS AREA

5.2.1.25.



LED OR FLUORESCENT LAMP LIGHTING FIXTURE 2X15/20cm
NORMAL CIRCUIT, POLE INSTALLATION
NOT CERTIFIED FOR HAZARDOUS AREA

5.2.1.26.



LED OR FLUORESCENT LAMP LIGHTING FIXTURE 2X15/20cm
ESSENTIAL CIRCUIT, POLE INSTALLATION
NOT CERTIFIED FOR HAZARDOUS AREA

5.2.1.27.



LED OR FLUORESCENT LAMP LIGHTING FIXTURE 2X15/20cm
EMERGENCY CIRCUIT, POLE INSTALLATION
NOT CERTIFIED FOR HAZARDOUS AREA

5.2.1.28.



LED OR FLUORESCENT LAMP LIGHTING FIXTURE 2X15/20cm
NORMAL CIRCUIT, FALSE CEILING INSTALLATION
NOT CERTIFIED FOR HAZARDOUS AREA

5.2.1.29.



LED OR FLUORESCENT LAMP LIGHTING FIXTURE 2X15/20cm
ESSENTIAL CIRCUIT, FALSE CEILING INSTALLATION
NOT CERTIFIED FOR HAZARDOUS AREA

5.2.1.30.



LED OR FLUORESCENT LAMP LIGHTING FIXTURE 2X15/20cm
EMERGENCY CIRCUIT, FALSE CEILING INSTALLATION
NOT CERTIFIED FOR HAZARDOUS AREA

5.2.1.31.

 LED OR FLUORESCENT LAMP LIGHTING FIXTURE 2X60cm
 NORMAL CIRCUIT, PENDANT INSTALLATION
 CERTIFIED FOR HAZARDOUS AREA

5.2.1.32.

 LED OR FLUORESCENT LAMP LIGHTING FIXTURE 2X60cm
 ESSENTIAL CIRCUIT, PENDANT INSTALLATION
 CERTIFIED FOR HAZARDOUS AREA

5.2.1.33.

 LED OR FLUORESCENT LAMP LIGHTING FIXTURE 2X60cm
 EMERGENCY CIRCUIT, PENDANT INSTALLATION
 CERTIFIED FOR HAZARDOUS AREA

5.2.1.34.

 LED OR FLUORESCENT LAMP LIGHTING FIXTURE 2X60cm
 NORMAL CIRCUIT, LONGITUDINAL INSTALLATION IN
 BULKHEAD
 CERTIFIED FOR HAZARDOUS AREA

5.2.1.35.

 LED OR FLUORESCENT LAMP LIGHTING FIXTURE 2X60cm
 ESSENTIAL CIRCUIT, LONGITUDINAL INSTALLATION IN
 BULKHEAD
 CERTIFIED FOR HAZARDOUS AREA

5.2.1.36.

 LED OR FLUORESCENT LAMP LIGHTING FIXTURE 2X60cm
 EMERGENCY CIRCUIT, LONGITUDINAL INSTALLATION IN
 BULKHEAD
 CERTIFIED FOR HAZARDOUS AREA

5.2.1.37.

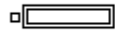
 LED OR FLUORESCENT LAMP LIGHTING FIXTURE 2X60cm
 NORMAL CIRCUIT, TRANSVERSAL INSTALLATION IN
 COLUMN OR BULKHEAD
 CERTIFIED FOR HAZARDOUS AREA

5.2.1.38.

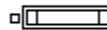
 LED OR FLUORESCENT LAMP LIGHTING FIXTURE 2X60cm
 ESSENTIAL CIRCUIT, TRANSVERSAL INSTALLATION IN
 COLUMN OR BULKHEAD
 CERTIFIED FOR HAZARDOUS AREA

5.2.1.39.

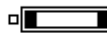
 LED OR FLUORESCENT LAMP LIGHTING FIXTURE 2X60cm
 EMERGENCY CIRCUIT, TRANSVERSAL INSTALLATION IN
 COLUMN OR BULKHEAD
 CERTIFIED FOR HAZARDOUS AREA

5.2.1.40.

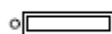
 LED OR FLUORESCENT LAMP LIGHTING FIXTURE 2X60cm
 NORMAL CIRCUIT, POLE INSTALLATION
 CERTIFIED FOR HAZARDOUS AREA

5.2.1.41.

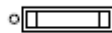
 LED OR FLUORESCENT LAMP LIGHTING FIXTURE 2X60cm
 ESSENTIAL CIRCUIT, POLE INSTALLATION
 CERTIFIED FOR HAZARDOUS AREA

5.2.1.42.

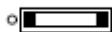
 LED OR FLUORESCENT LAMP LIGHTING FIXTURE 2X60cm
 EMERGENCY CIRCUIT, POLE INSTALLATION
 CERTIFIED FOR HAZARDOUS AREA

5.2.1.43.

 LED OR FLUORESCENT LAMP LIGHTING FIXTURE 2X15/20cm
 NORMAL CIRCUIT, PENDANT INSTALLATION
 CERTIFIED FOR HAZARDOUS AREA

5.2.1.44.

 LED OR FLUORESCENT LAMP LIGHTING FIXTURE 2X15/20cm
 ESSENTIAL CIRCUIT, PENDANT INSTALLATION
 CERTIFIED FOR HAZARDOUS AREA

5.2.1.45.

 LED OR FLUORESCENT LAMP LIGHTING FIXTURE 2X15/20cm
 EMERGENCY CIRCUIT, PENDANT INSTALLATION
 CERTIFIED FOR HAZARDOUS AREA

5.2.1.46.

 LED OR FLUORESCENT LAMP LIGHTING FIXTURE 2X15/20cm
 NORMAL CIRCUIT, LONGITUDINAL INSTALLATION IN
 BULKHEAD
 CERTIFIED FOR HAZARDOUS AREA

5.2.1.47.

 LED OR FLUORESCENT LAMP LIGHTING FIXTURE 2X15/20cm
 ESSENTIAL CIRCUIT, LONGITUDINAL INSTALLATION IN
 BULKHEAD
 CERTIFIED FOR HAZARDOUS AREA

5.2.1.48.

 LED OR FLUORESCENT LAMP LIGHTING FIXTURE 2X15/20cm
 EMERGENCY CIRCUIT, LONGITUDINAL INSTALLATION IN
 BULKHEAD
 CERTIFIED FOR HAZARDOUS AREA

5.2.1.49.

 LED OR FLUORESCENT LAMP LIGHTING FIXTURE 2X15/20cm
 NORMAL CIRCUIT, TRANSVERSAL INSTALLATION IN
 COLUMN OR BULKHEAD
 CERTIFIED FOR HAZARDOUS AREA

5.2.1.50.

 LED OR FLUORESCENT LAMP LIGHTING FIXTURE 2X15/20cm
 ESSENTIAL CIRCUIT, TRANSVERSAL INSTALLATION IN
 COLUMN OR BULKHEAD
 CERTIFIED FOR HAZARDOUS AREA

5.2.1.51.

 LED OR FLUORESCENT LAMP LIGHTING FIXTURE 2X15/20cm
 EMERGENCY CIRCUIT, TRANSVERSAL INSTALLATION IN
 COLUMN OR BULKHEAD
 CERTIFIED FOR HAZARDOUS AREA

5.2.1.52.

 LED OR FLUORESCENT LAMP LIGHTING FIXTURE 2X15/20cm
 NORMAL CIRCUIT, POLE INSTALLATION
 CERTIFIED FOR HAZARDOUS AREA

5.2.1.53.

 LED OR FLUORESCENT LAMP LIGHTING FIXTURE 2X15/20cm
 ESSENTIAL CIRCUIT, POLE INSTALLATION
 CERTIFIED FOR HAZARDOUS AREA

5.2.1.54.

 LED OR FLUORESCENT LAMP LIGHTING FIXTURE 2X15/20cm
 EMERGENCY CIRCUIT, POLE INSTALLATION
 CERTIFIED FOR HAZARDOUS AREA

5.2.1.55.

 FLOODLIGHT – NORMAL CIRCUIT
NOT CERTIFIED FOR HAZARDOUS AREA

5.2.1.56.

 FLOODLIGHT – POLE INSTALLATION – NORMAL CIRCUIT
NOT CERTIFIED FOR HAZARDOUS AREA

5.2.1.57.

 FLOODLIGHT – ESSENTIAL CIRCUIT
NOT CERTIFIED FOR HAZARDOUS AREA

5.2.1.58.

 FLOODLIGHT – POLE INSTALLATION – ESSENTIAL CIRCUIT
NOT CERTIFIED FOR HAZARDOUS AREA

5.2.1.59.

 FLOODLIGHT – NORMAL CIRCUIT
CERTIFIED FOR HAZARDOUS AREA

5.2.1.60.

 FLOODLIGHT – POLE INSTALLATION – NORMAL CIRCUIT
CERTIFIED FOR HAZARDOUS AREA

5.2.1.61.

 FLOODLIGHT – ESSENTIAL CIRCUIT
CERTIFIED FOR HAZARDOUS AREA

5.2.1.62.

 FLOODLIGHT – POLE INSTALLATION – ESSENTIAL CIRCUIT
CERTIFIED FOR HAZARDOUS AREA

5.2.1.63.



FLOODLIGHT – LIFEBOAT AND LANDING AREA

5.2.1.64.



RESCUE AND SEARCH LIGHT

5.2.1.65.

 INCANDESCENT LAMP LIGHTING FIXTURE WITH SWITCH
MAX. 60W, WALL TYPE SURFACE MOUNTING
NOT CERTIFIED FOR HAZARDOUS AREA

5.2.1.66.

 INCANDESCENT LAMP LIGHTING FIXTURE MAX. 60W,
NORMAL CIRCUIT, FALSE CEILING MOUNTING
NOT CERTIFIED FOR HAZARDOUS AREA

5.2.1.67.

 SODIUM VAPOUR LIGHTING FIXTURE, NORMAL CIRCUIT
PENDANT INSTALLATION
NOT CERTIFIED FOR HAZARDOUS AREA

5.2.1.68.

 SODIUM VAPOUR LIGHTING FIXTURE, ESSENTIAL CIRCUIT
PENDANT INSTALLATION
NOT CERTIFIED FOR HAZARDOUS AREA

5.2.1.69.

 SODIUM VAPOUR LIGHTING FIXTURE, NORMAL CIRCUIT
 PENDANT INSTALLATION
 CERTIFIED FOR HAZARDOUS AREA

5.2.1.70.

 SODIUM VAPOUR LIGHTING FIXTURE, ESSENTIAL CIRCUIT
 PENDANT INSTALLATION
 CERTIFIED FOR HAZARDOUS AREA

5.2.1.71.

 UNIVERSAL ELECTRICAL RECEPTACLE (2P+T/110 TO 240V)
 h=2,20m

5.2.1.72.

 UNIVERSAL ELECTRICAL RECEPTACLE (2P+T/110 TO 240V)
 h=0,30m

5.2.1.73.

 UNIVERSAL ELECTRICAL RECEPTACLE (2P+T/110 TO 240V)
 h=1,20m

5.2.1.74.



ELECTRICAL RECEPTACLE (3P+T/380 TO 690V)

5.2.1.75.



ELECTRICAL RECEPTACLE (3P+T/110 TO 240V)

5.2.2. CABLE TRAY







5.2.2.1.



SUPPORT FOR CABLE TRAY CHANNEL

6. PROCESS

6.1. PROCESS FLOW DIAGRAMS AND P&IDS

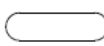
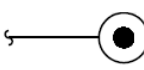
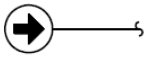
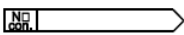
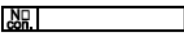
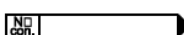
6.1.1.		STREAM NUMBER
6.1.2.		PRESSURE
6.1.3.		TEMPERATURE (°C)
6.1.4.		LIQUID FLOW
6.1.5.		GAS FLOW
6.1.6.		STEAM
6.1.7.		SPECIFIC GRAVITY, DENSITY OR MOLECULAR WEIGHT
6.1.8.		THERMAL DUTY
6.1.9.		END OF FLOW (SYSTEM OR PROCESS)
6.1.10.		START OF FLOW (SYSTEM OR PROCESS)
6.1.11.		TO/FROM TO FLOW DIAGRAM
6.1.12.		DISTRIBUTION CONNECTOR
6.1.13.		UNIT CONNECTOR

6.2. UTILITY AND FACILITY CODES TO BE USED IN PIPING AND INSTRUMENTATION DIAGRAMS (P&IDs)

**TECHNICAL SPECIFICATION**

No.

I-ET-3000.00-0000-940-P4X-002

REV.

F

AREA:

SHEET:

93 of 124

TITLE:

SYMBOLS FOR PRODUCTION UNITS DESIGN**INTERNAL****ESUP**

6.2.1.



SOUR WATER

6.2.2.



MEDIUM PRESSURE FEED WATER

6.2.3.



HIGH PRESSURE FEED WATER

6.2.4.



HOT WATER

6.2.5.



DEMINERALIZED WATER

6.2.6.



FIRE FIGHTING WATER

6.2.7.



DRINKING WATER

6.2.8.



PROCESS WATER

6.2.9.



MAKE-UP WATER

6.2.10.



COOLING WATER

6.2.11.



MACHINERY COOLING WATER

6.2.12.



SEA WATER

6.2.13.



FRESH WATER

6.2.14.



WARM WATER

6.2.15.



DISTILLED WATER

**TECHNICAL SPECIFICATION**

No.

I-ET-3000.00-0000-940-P4X-002

REV.

F

AREA:

SHEET:

94 of 124

TITLE:

SYMBOLS FOR PRODUCTION UNITS DESIGN**INTERNAL****ESUP**

6.2.16.



See note(s) 5 at the end of this section

6.2.17.



See note(s) 5 at the end of this section

6.2.18.



See note(s) 5 at the end of this section

6.2.19.



See note(s) 5 at the end of this section

6.2.20.



SPECIAL UTILITY

See note(s) 2 at the end of this section

6.2.21.



INSTRUMENT AIR

6.2.22.



SERVICE AIR

6.2.23.



See note(s) 5 at the end of this section

6.2.24.



See note(s) 5 at the end of this section

6.2.25.



See note(s) 5 at the end of this section

6.2.26.



See note(s) 5 at the end of this section

6.2.27.

HYDROCARBON OPEN DRAIN FOR TURRET AREA
(SAMPLE CONNECTION, INSTRUMENT DRAIN)

6.2.28.



OPEN DRAIN FOR TURRET AREA

6.2.29.



CLOSED DRAIN FOR TURRET AREA

6.2.30.



SPECIAL UTILITY

See note(s) 2 at the end of this section

6.2.31.



RAIN WATER HEADER

6.2.32.



SOUR CONDENSATE

**TECHNICAL SPECIFICATION**

No.

I-ET-3000.00-0000-940-P4X-002

REV.

F

AREA:

SHEET:

95 of 124

TITLE:

SYMBOLS FOR PRODUCTION UNITS DESIGN**INTERNAL****ESUP**

6.2.33.



PUMPED CONDENSATE

6.2.34.



OPEN DRAIN

6.2.35.



CLOSED DRAIN

6.2.36.



OVERBOARD

6.2.37.

HYDROCARBON OPEN DRAIN
(SAMPLE CONNECTION, INSTRUMENT DRAIN)

6.2.38.



CAUSTIC DRAIN

6.2.39.



PUMP OUT

6.2.40.



OILY WATER

6.2.41.



AMINIC DRAIN

6.2.42.



SEWAGE

6.2.43.



BLOW-DOWN

6.2.44.



DRAIN TO BILGE WELLS

6.2.45.

OPEN DRAIN NON-CLASSIFIED AREA
(DIESEL OIL SYSTEM, LABORATORY, WORKSHOPS)

6.2.46.



See note(s) 5 at the end of this section

6.2.47.



See note(s) 5 at the end of this section

6.2.48.



See note(s) 5 at the end of this section

6.2.49.



See note(s) 5 at the end of this section

**TECHNICAL SPECIFICATION**

No.

I-ET-3000.00-0000-940-P4X-002

REV.

F

AREA:

SHEET:

96 of 124

TITLE:

SYMBOLS FOR PRODUCTION UNITS DESIGN**INTERNAL****ESUP**

6.2.50.



SPECIAL UTILITY

See note(s) 2 at the end of this section

6.2.51.



SOUR GAS

6.2.52.



FUEL GAS

6.2.53.



INERT GAS

6.2.54.



RESIDUAL GAS

6.2.55.



HYDROGEN

6.2.56.



NITROGEN

6.2.57.



OXYGEN

6.2.58.



See note(s) 5 at the end of this section

6.2.59.



See note(s) 5 at the end of this section

6.2.60.



SPECIAL UTILITY

See note(s) 2 at the end of this section

6.2.61.



FUEL OIL

6.2.62.



DIESEL OIL

6.2.63.



FLUSHING OIL

6.2.64.



HIGH WASHING OIL

6.2.65.



SLOP OIL ("SLOP")

6.2.66.



HEAVY OIL

**TECHNICAL SPECIFICATION**

No.

I-ET-3000.00-0000-940-P4X-002

REV.

F

AREA:

SHEET:

97 of 124

TITLE:

SYMBOLS FOR PRODUCTION UNITS DESIGN**INTERNAL****ESUP**

6.2.67.



GLAND OIL

6.2.68.



INSTRUMENT SEALING OIL

6.2.69.



See note(s) 5 at the end of this section

6.2.70.



SPECIAL UTILITY

See note(s) 2 at the end of this section

6.2.71.



ANTI-FOAM

6.2.72.



AMONIA

6.2.73.



ETHANOL

6.2.74.



GLYCOL

6.2.75.



METHANOL

6.2.76.



FRESH CAUSTIC SOLUTION

6.2.77.



See note(s) 5 at the end of this section

6.2.78.



See note(s) 5 at the end of this section

6.2.79.



See note(s) 5 at the end of this section

6.2.80.



SPECIAL UTILITY

See note(s) 2 at the end of this section

6.2.81.



LOW PRESSURE CONDENSATE

6.2.82.



MEDIUM PRESSURE CONDENSATE

6.2.83.



HIGH PRESSURE CONDENSATE

**TECHNICAL SPECIFICATION**

No.

I-ET-3000.00-0000-940-P4X-002

REV.

F

AREA:

SHEET:

98 of 124

TITLE:

SYMBOLS FOR PRODUCTION UNITS DESIGN**INTERNAL****ESUP**

6.2.84.



LOW PRESSURE STEAM

6.2.85.



MEDIUM PRESSURE STEAM

6.2.86.



HIGH PRESSURE STEAM

6.2.87.



SUPERHEATED LOW PRESSURE STEAM

6.2.88.



DE-SUPERHEATED LOW PRESSURE STEAM

6.2.89.



TURRET VENT

6.2.90.



SPECIAL UTILITY

See note(s) 2 at the end of this section

6.2.91.



HIGH PRESSURE FLARE

See note(s) 3 at the end of this section

6.2.92.



VENT

6.2.93.



LOW PRESSURE FLARE

6.2.94.



HIGH PRESSURE FLARE

6.2.95.



FLARE

6.2.96.



SOUR FLARE

6.2.97.



SPECIAL UTILITY

See note(s) 2 at the end of this section

6.2.98.



LOW PRESSURE VENT

6.2.99.



HIGH PRESSURE VENT

6.2.100.



SPECIAL UTILITY

See note(s) 1 at the end of this section

Notes:

- (1) Points where 2 or more utilities have to be used.
- (2) Codes for special utilities defined for a specific project/process.
- (3) Independent header for gas compressor packages.
- (4) (XXXXX) Reference to utility connector number.
- (5) Non-standardized symbols, which may be used in projects if necessary.

7. AIR CONDITIONING AND VENTILATION
7.1. EQUIPMENT

7.1.1.

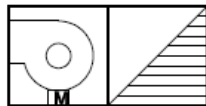

FAN-COIL AIR CONDITIONING UNIT

7.1.2.

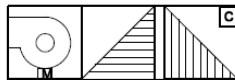

SELF-CONTAINED AIR CONDITIONING UNIT (P&ID)

7.1.3.

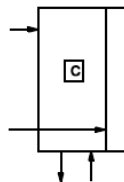

CHILLED WATER UNIT (WATER COOLED)

7.1.4.

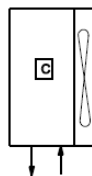

CONDENSING UNIT (AIR COOLED)

7.1.5.

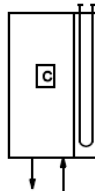

CONDENSING UNIT (WATER COOLED)

7.1.6.

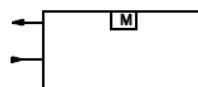

FORCED EVAPORATOR FOR COLD-STORAGE CHAMBERS

7.1.7.

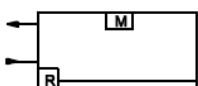

FORCED EVAPORATOR FOR COLD-STORAGE CHAMBERS WITH HEATER

7.1.8.

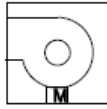

CENTRIFUGAL FAN

7.1.9.



AXIAL FAN

7.2. LINE ACCESSORIES

7.2.1.



FLEXIBLE CANVAS CONNECTION

7.2.2.



FIRE DAMPER

7.2.3.



MODULATING DAMPER

7.2.4.



NON-RETURN OR PRESSURE-RELIEF DAMPER

7.2.5.



MANUAL DAMPER

7.2.6.



AUTOMATIC DAMPER

7.2.7.



MANUAL ADJUSTMENT

7.2.8.



COARSE FILTER

7.2.9.



FINE FILTER

7.2.10.



DROP SEPARATOR

7.2.11.

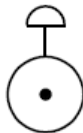

GAS TIGHT DAMPER

7.2.12.

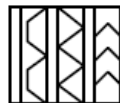
 FILTERING BOX
 OBS.: OTHER FILTERS COMBINATIONS MAY BE USED INSIDE
 THE BOX

7.2.13.

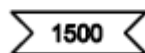

 FLOW FLAG (E.G.: 1500 m³/h)

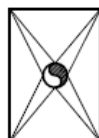
7.2.14.

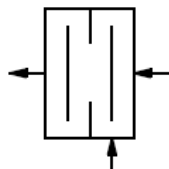

EXHAUST HOOD

7.2.15.



MIXING BOX

7.2.16.



AIR HEATER (DUCT INSTALLATION)

7.2.17.



WATERTIGHT VALVE

7.2.18.



AIR FILTER AND PRESSURE REGULATOR

7.3. SUNDRIES

7.3.1.



CONDITIONED AIR SUPPLY

7.3.2.



CONDITIONED AIR RETURN

7.3.3.



VENTILATION

7.3.4.



EXHAUSTION

7.3.5.

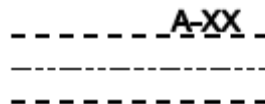

 CLASSIFIED DUCT (XX = 0,15,30 OR 60)
 OBS.: VALID FOR ALL OF THE ABOVE DUCT LINES

7.3.6.

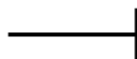

DIFFUSER

7.3.7.



LATERAL GRILLE

7.3.8.

GJP

GRILLE NEAR FLOOR

7.3.9.

GJT

GRILLE NEAR CEILING

7.3.10.



GRILLE IN BULKHEAD

7.3.11.



DIRECTION OF SUPPLY AIR

7.3.12.

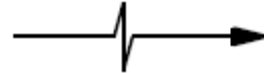

DIRECTION OF RETURN OR EXHAUST AIR

7.3.13.

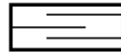

SOUND ABSORBER

7.3.14.

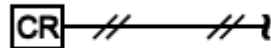

REFERENCE SENSOR

7.3.15.



VENTILATION HOOD

7.4. ROOMS

7.4.1.



HVAC ROOM CONNECTOR - IN

7.4.2.



HVAC ROOM CONNECTOR - OUT

7.4.3.



ROOM

8. ARCHITECTURE

The definition of symbols that apply to architecture items is in HOLD.

9. NAVAL

9.1. LINE ACCESSORIES

9.1.1.



SCUPPER



SCUPPER (PLANT)

9.1.2.

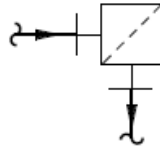

MUD BOX

9.1.3.

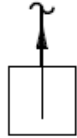

ROSE BOX

9.1.4.

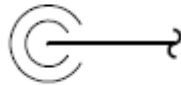

DOWN PIPE

9.1.5.

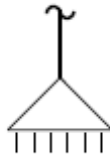

SUCTION BELL MOUTH

9.1.6.



DROP LINE

9.1.7.



SCUPPER WITH SYPHON

9.1.8.

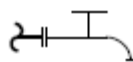

TAP

9.1.9.

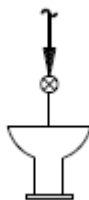

VASE (INLET)

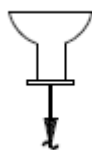

VASE (OUTLET)

9.1.10.

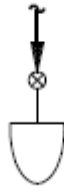

URINAL (INLET)

9.1.11.



URINAL (OUTLET)

9.1.12.



SOUNDING CAP FOR PIPE

9.1.13.

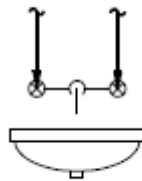

BASIN WITH MIXER

9.1.14.

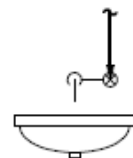

BASIN WITH TAP (INLET)

9.1.15.

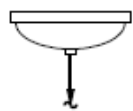

BASIN (OUTLET)

9.1.16.

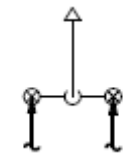

SHOWER WITH MIXER

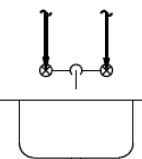

SINK WITH MIXER

9.1.17.

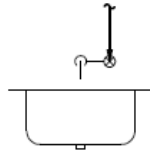

SINK WITH TAP (INLET)

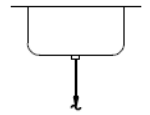

SINK (OUTLET)

9.1.18.

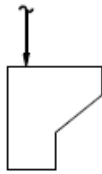

TANK (INLET)

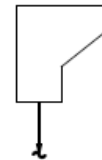

TANK (OUTLET)

9.1.19.



ATMOSPHERIC VENT TYPE 2 (ATMOSPHERIC WEATHERTIGHT VENT)

9.1.20.

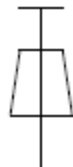

DIRECT ACTION

9.1.21.

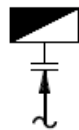

HEAD VENT WITH FLAME SCREEN AND FLOATS

9.1.22.



NAVAL TANK (TYPE 2)

9.1.23.



NAVAL TANK

9.1.24.



SURFACE VALVE

9.2. EQUIPMENT DRIVERS (PUMPS)

9.2.1.



GEAR PUMP

9.2.2.

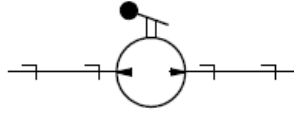

MANUAL HYDRAULIC PUMP

9.3. EQUIPMENT DRIVERS (MOTOR AND ENGINES)

9.3.1.

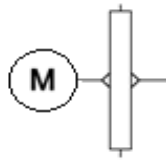

MECHANICAL COUPLING

9.3.2.

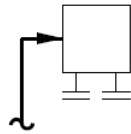

HYDRAULIC MOTOR (PLANT)

9.4. EQUIPMENT DRIVERS (OTHER ITEMS)

9.4.1.

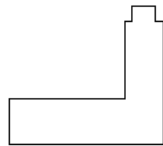

INERT GAS GENERATOR

10. TELECOMMUNICATION
10.1. PUBLIC ADDRESS AND GENERAL ALARM SYSTEM

10.1.1.



CIT – PUBLIC ADDRESS CENTRAL STATION

10.1.2.



AMP – AUDIO AMPLIFIER

10.1.3.



MA – AMPLIFICATION MONITOR

10.1.4.

MIC – PRIORITY MICROPHONE

10.1.5.

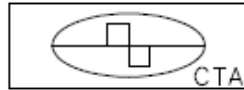
CTA – ALARMS TONE GENERATOR

10.1.6.

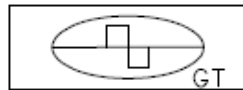
GT – TESTS TONE GENERATOR

10.1.7.

FAI – POWER SUPPLY FOR PUBLIC ADDRESS STATION

10.1.8.

CA – ALARMS COMMAND SWITCH (ABANDON, EMERGENCY AND RESET)

10.1.9.

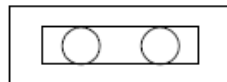
FP – AUDIO PROGRAM SOURCE

10.1.10.

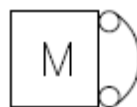
ECC – PAGE PARTY STATION, DESK TYPE

10.1.11.

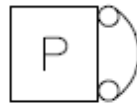
ECC – PAGE PARTY STATION, WALL TYPE

10.1.12.

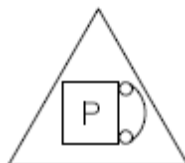
ECC – PAGE PARTY STATION, WALL TYPE, IN ACOUSTIC BOOTH

10.1.13.

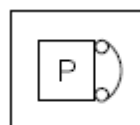

ECC – PAGE PARTY STATION, WALL TYPE, IN PROTECTION BOX

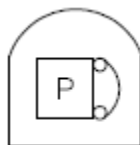
10.1.14.

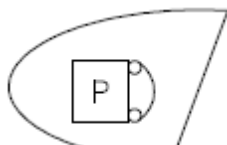

ECC – PAGE PARTY STATION, WALL TYPE, IN HALF SIZE ACOUSTIC BOOTH

10.1.15.



ECC – PAGE PARTY STATION, WALL TYPE, IN ACOUSTIC SHELL

10.1.16.



CAC – ACOUSTIC BOX

10.1.17.



AFT – CEILING LOUDSPEAKER

10.1.18.

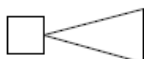

COR – ACOUSTIC HORN

10.1.19.



LSE – EMERGENCY LAMP – FLASH LIGHT – WHITE COLOR

10.1.20.



CFI – INTERCOMMUNICATION WIRING BOX

10.1.21.

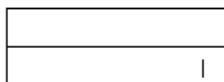

DGI – GENERAL INTERCOMMUNICATION DISTRIBUTOR

10.1.22.

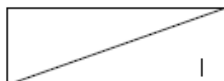

CDI - INTERCOMMUNICATION DISTRIBUTOR BOX

10.1.23.

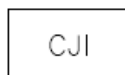

CJI – INTERCOMMUNICATION JUNCTION BOX

10.1.24.



CJS – CONNECTION BOX

10.1.25.



ACU – CONSOLE WITH CA-COMAND ALARM SWITCH, MIC PRIORITY MICROPHONE AND ECC-PAGE PARTY STATION

10.1.26.

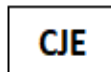

CJE – ELECTRICAL JUNCTION BOX

10.2. TELEPHONE SYSTEM

10.2.1.



TTF – TELEPHONE PLUG SOCKET

10.2.2.



TEL – DESK TELEPHONE

10.2.3.



TEL – WALL TELEPHONE

10.2.4.



TEL – WALL TELEPHONE IN ACOUSTIC BOOTH

10.2.5.

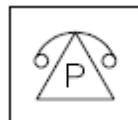

TEL – WALL TELEPHONE IN PROTECTION BOX

10.2.6.



TEL – WALL TELEPHONE IN ACOUSTIC HOOD

10.2.7.



TEL – WALL TELEPHONE IN ACOUSTIC SHELL

10.2.8.

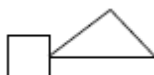

BUZ - BUZZER

10.2.9.

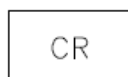

CR – RELAY BOX

10.2.10.



CMP – ELECTRONIC BELL

10.2.11.



BLT – TELEPHONE ALARM AND SIGNALING LAMP

10.2.12.



LST – TELEPHONE SIGNALLING LAMP – GREEN COLOR

10.2.13.



CFT – TELEPHONE WIRING BOX

10.2.14.

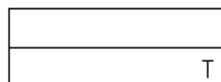

DGT – GENERAL TELEPHONE DISTRIBUTOR

10.2.15.

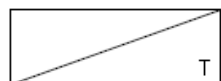

CDT – TELEPHONE DISTRIBUTION BOX

10.2.16.

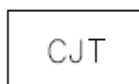

CJT – TELEPHONE JUNCTION BOX



10.2.17.

PABX/T

CTF – PRIVATE AUTOMATIC BRANCH EXCHANGE OR PABX TELEPHONE CENTRAL STATION

10.3. TRANSMISSION SYSTEM

10.3.1.

HCS

HCS – HYBRID / SIGNAL CONVERTER

10.3.2.

LTE

LTE – LTE EQUIPMENT

10.3.3.

MUX

MUX – MULTIPLEX EQUIPMENT (OPTICAL/SDH/TDM)

10.3.4.

MD

MD – MODEM SATELLITE

10.3.5.

RD

RDO – DIGITAL RADIO

10.3.6.

GPS

GPS – GPS COMPASS

10.3.7.

ASC

ASC – ANTENNA STABILIZATION CONTROL UNIT

10.3.8.

BAS

BAS – RACK FOR HOUSING EQUIPMENTS

**10.4. OPERATIONAL RADIO SYSTEM**

10.4.1.

CRO

CRO – OPERATIONAL RADIO CONSOLE

10.4.2.

TX

TX – RADIO TRANSMITTER

10.4.3.

RX

RX – RADIO RECEIVER

10.4.4.

TRX

TRX – RADIO TRANSCEIVER

10.4.5.

STO

STO – ANTENNA TUNER / COUPLER

10.4.6.

SRT

SRT – RADAR TRANSPONDER FOR SEARCH AND RESCUE OPERATION

10.4.7.

CRE

CRE – REMOTE CONTROL

10.4.8.

UCO

UCO – CONTROL UNIT

10.4.9.

INM

INM – INMARSAT TRANSCEIVER

10.4.10.

AIS

AIS – AUTOMATIC IDENTIFICATION SYSTEM

10.4.11.

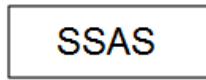

SSAS – SHIP SECURITY ALERT SYSTEM

10.4.12.

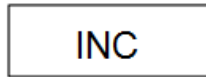

INC – INMARSAT C

10.4.13.



LOUDSPEAKER

10.4.14.



MICROPHONE WITH PTT

10.5. ANTENNAS SYSTEM

10.5.1.



ANT – CO-LINEAR ANTENNA

10.5.2.



ANT – GROUND PLANE TYPE ANTENNA

10.5.3.



ANT – WHIP ANTENNA

10.5.4.

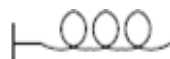

ANT – HELICAL ANTENNA

10.5.5.

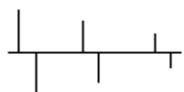

ANT – LOG-PERIODIC ANTENNA

10.5.6.

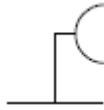

ANT – PARABOLIC ANTENNA

10.5.7.

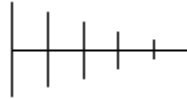

ANT – YAGI ANTENNA

10.5.8.



ANT – OMNI ANTENNA (UHF TV)

10.5.9.



ANT – GPS / INMARSAT-C / INMARSAT-FBB ANTENNAS

10.5.10.

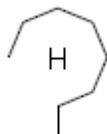

ANT – NDB HELIPAD ANTENNA

10.5.11.



TT – TELECOMMUNICATION TOWER

10.5.12.



ANT – ANTENNA VSAT (VERY-SMALL-APERTURE-TERMINAL)

10.5.13.

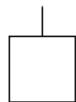

LIGHTNING ARRESTER

10.6. TELECOMMUNICATION ENERGY SYSTEM

10.6.1.



FCC – DIRECT CURRENT POWER SUPPLY

10.6.2.

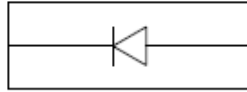

UDQ – DROPPING DIODE UNIT

10.6.3.

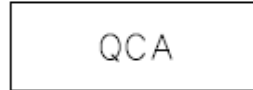

QCA – AC DISTRIBUTION BOARD

10.6.4.

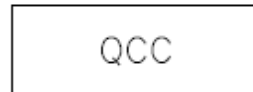

QCC – DC DISTRIBUTION BOARD

10.6.5.



USCA – AC MONITORING UNIT

10.6.6.



USCC – DC MONITORING UNIT

10.6.7.

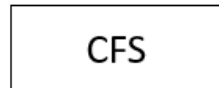

CFS – FUSE BOX

10.7. DATA COMMUNICATION SYSTEM

10.7.1.



ECD – DATA COMMUNICATIONS EQUIPMENT

10.7.2.



MCO – MICROCOMPUTER (WORKSTATION)

10.7.3.



IMP - PRINTER

10.7.4.



SW – LAYER 2 SWITCH

10.7.5.

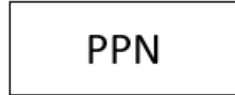

PPN – PATCH PANEL

10.7.6.



PDD – DATA DISTRIBUTOR PANEL

10.7.7.

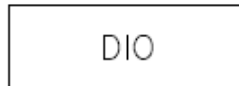

DIO – OPTICAL INTERNAL DISTRIBUTOR

10.7.8.



ROT - ROUTER

10.7.9.



TMD – DATA PLUG SOCKET

10.7.10.



GK – ACCESS MEDIA GATEWAY / GATEKEEPER

10.7.11.

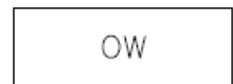

OW – WAN OPTIMIZATOR

10.7.12.

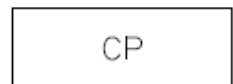

CP – WLAN CONTROLLER

10.7.13.



FW – FIREWALL

10.7.14.



PA – WLAN ACCESS POINT

10.7.15.

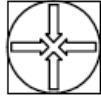

SW – LAYER 3 SWITCH

10.7.16.

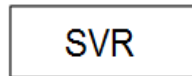

SVR - SERVER

10.7.17.



CCD – DATA CONNECTION BOX

10.7.18.

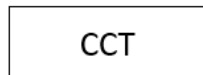

CCT – TELECOMMUNICATION CONNECTION BOX

10.7.19.

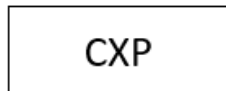

CXP – DISTRIBUTION BOX FOR TELEPHONE, DATA AND INTERCOM

10.8. TV SYSTEM

10.8.1.



ATV – TV AMPLIFIER

10.8.2.

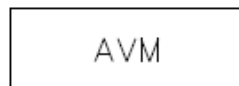

AVM – AUDIO AND VIDEO MONITOR

10.8.3.



DCD – DIGITAL SATELLITE DECODER (KU BAND)

10.8.4.



DSR - DIGITAL SATELLITE RECEIVER

10.8.5.



DTV – TV CHANNEL DISTRIBUTOR

10.8.6.



DVD – DVD PLAYER

10.8.7.



MAV – AUDIO AND VIDEO MODULATOR

10.8.8.



MTV – TV CHANNEL MIXER

10.8.9.



PTV – TV RACK

10.8.10.



RX – UHF TUNNER

10.8.11.



TAP – DIRECTIONAL COUPLER

10.8.12.



TTV – F TYPE TV PLUG SOCKET, BY PASS UNIT

10.8.13.



TTV – IPTV DATA PLUG SOCKET

10.8.14.



TTV – F TYPE TV PLUG SOCKET, TERMINATED

10.8.15.

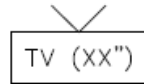

TV – TV EQUIPMENT

10.8.16.

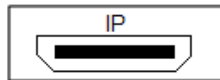

HDI – HIGH-DEFINITION-MULTIMEDIA INTERFACE IP (HDMI IP)

10.8.17.

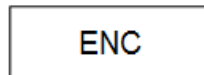

ENC – ENCODER HDMI/IP

10.8.18.

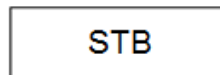

STB – SETUP BOX IP/HDMI

10.9. UHF ACTIVE REPEATER SYSTEM

10.9.1.



ANT – OMNI ANTENNA INDOOR

10.9.2.



ANT – OMNI ANTENNA OUTDOOR

10.9.3.



RPT – UHF ACTIVE REPEATER SYSTEM RACK

10.9.4.



CNT - CONNECTOR

10.9.5.



DIV - SPLITTER

10.9.6.

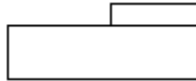

ACO - DIRECTIONAL COUPLER

10.9.7.

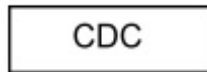

CDC - COAXIAL DISTRIBUTION BOX

10.9.8.

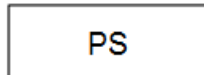

PS - SURGE ARRESTOR

10.9.9.

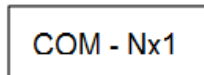

COM - COMBINER - Nx1

10.9.10.

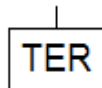

TER - UHF LOAD UP

10.9.11.

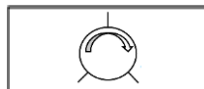

CIR - CIRCULATOR

10.10. VIDEOCONFERENCE SYSTEM

10.10.1.



COD - CODEC

10.10.2.



CAM - CAMERA

10.10.3.



MIC - MICROPHONE

10.11. CLOSED-CIRCUIT TELEVISION SYSTEM - CCTV

10.11.1.



ENC – ENCODER (NETWORK VIDEO RECORDER)

10.11.2.

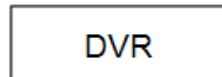

ENC – ENCODER (DIGITAL VIDEO RECORDER)

10.11.3.

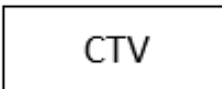

CTV – RACK FOR CCTV SYSTEM

10.11.4.

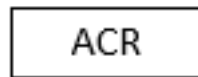

AERONAUTICAL COMMUNICATIONS RECORDER

10.11.5.



CAM – FIXED CAMERA

10.11.6.



CAM – PTZ CAMERA

10.11.7.

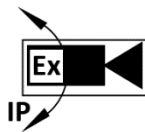

CAM – EXPLOSION-PROOF PTZ CAMERA

10.11.8.



CAM – EXPLOSION-PROOF PTZ IP THERMAL CAMERA

10.11.9.



CAM – EXPLOSION-PROOF FIXED IP CAMERA

10.11.10.



CAM – EXPLOSION-PROOF IP DUAL OPTICAL AND THERMAL FIXED CAMERA

10.11.11.

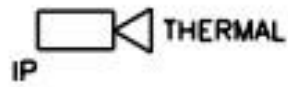

CAM – FIXED IP THERMAL CAMERA

10.11.12.



CAM – FIXED IP CAMERA WITH DOME

10.11.13.



CAM – PTZ IP CAMERA WITH DOME

10.11.14.



CAM – EXPLOSION-PROOF PTZ IP CAMERA WITH DOME

10.11.15.



CAM – EXPLOSION-PROOF WIFI IP NOMADIC FIXED CAMERA

10.11.16.



CAM – EXPLOSION-PROOF WIFI CAMERA FOR USE IN SAFETY HELMETS

10.11.17.



CAM – FIXED MULTISENSOR IP CAMERA WITH DOME (360° FIELD OF VIEW)

10.11.18.



CAM – EXPLOSION_PROOF FIXED PANORAMIC IP CAMERA WITH DOME (180° FIELD OF VIEW)

10.12. PARTS AND ACCESSORIES FOR INSTALLATION

10.12.1.

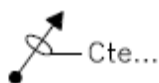

INDICATION OF RISER FOR CABLE

10.12.2.

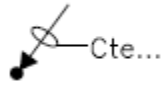

INDICATION OF DESCENDER FOR CABLE

10.12.3.



CABLE TRAY (B); CABLES AND TUBING CHANNEL (C); DUCT (D)

10.12.4.

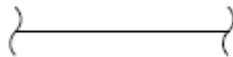

CABLE; WIRING; CONDUIT (E)

10.12.5.



MCT – MUTI-CABLE TRANSIT BOX

11. STRUCTURE

11.1. TOPSIDE STRUCTURES

Symbology for topside structures shall be in accordance with project's General Notes for Topsides Structures.

11.2. HULL STRUCTURES

Symbology for hull structures shall be in accordance with project's Hull General Notes and Typical Details.