	<b>TECHNICAL SPECIFICATION</b>	Nº: <b>I-ET-3010.00-5514-76A-PPT-002</b>
	CLIENT: <b>SRGE</b>	SHEET: <b>1</b> of <b>19</b>
	JOB: <b>CLOSED-CIRCUIT (CCTV)</b>	
	AREA: <b>-</b>	
<b>TIC</b>	TITLE: <b>TOPSIDES CCTV SYSTEM</b>	<b>INTERNAL</b> <b>OI/CS</b>

MICROSOFT WORD / V.2016 / I-ET-3010.00-5514-76A-PPT-002\_D.docx

**REVISION INDEX**

REV.	DESCRIPTION AND/OR REVISED SHEETS
0	ORIGINAL ISSUE
A	REVISED WHERE INDICATED
B	REVISED WHERE INDICATED
C	REVISED WHERE INDICATED; REMOVED ITEM 6.1.4.H
D	EXCLUDED 6.1.1n

	REV. 0	REV. A	REV. B	REV. C	REV. D	REV. E	REV. F	REV. G	REV. H
DATE	APR/08/22	OCT/25/2022	NOV/10/2022	MAY/04/2023	JUL/09/2024				
DESIGN	PROJ-US	PROJ-US	PROJ-US	PROJ-US	PROJ-US				
EXECUTION	Y3S7	Y3S7	Y3S7	Y3S7	X187				
CHECK	CY22	CY22	CY22	CY22	CY22				
APPROVAL	X187	X187	X187	X187	Y3S7				

INFORMATION IN THIS DOCUMENT IS PROPERTY OF PETROBRAS, BEING PROHIBITED OUTSIDE OF THEIR PURPOSE  
FORM OWNED TO PETROBRAS N-0381 REV. L



<b>TECHNICAL SPECIFICATION</b>	Nº: <b>I-ET-3010.00-5514-76A-PPT-002</b>	REV. <b>D</b>
AREA: -	SHEET: 2 of 19	
TITLE: <b>TOPSIDES CCTV SYSTEM</b>		<b>INTERNAL</b>
		<b>OI/CS</b>

**INDEX**

<b>1. SUBJECT .....</b>	<b>3</b>
<b>2. ABBREVIATIONS .....</b>	<b>3</b>
<b>3. REFERENCE DOCUMENTS, CODES AND STANDARDS .....</b>	<b>3</b>
<b>4. GENERAL REQUIREMENTS .....</b>	<b>4</b>
<b>5. SYSTEM DEFINITIONS.....</b>	<b>7</b>
<b>6. TECHNICAL REQUIREMENTS.....</b>	<b>10</b>
<b>7. SCOPE OF SUPPLY .....</b>	<b>17</b>
<b>8. DIMENSIONING CRITERIA .....</b>	<b>18</b>
<b>9. COMMISSIONING .....</b>	<b>18</b>
<b>10. CRANE CAMERA INTEGRATION WITH THE HULL CCTV SYSTEM .....</b>	<b>19</b>

	<b>TECHNICAL SPECIFICATION</b>	Nº: <b>I-ET-3010.00-5514-76A-PPT-002</b>	REV. <b>D</b>
	AREA:	SHEET:	
	TITLE:	3 of 19	
	<b>TOPSIDES CCTV SYSTEM</b>		INTERNAL
			OI/CS

## 1. SUBJECT

- 1.1 This technical specification describes the minimum requirements and basic characteristics for the supply of the Closed-Circuit Television System (CCTV) to be installed in PETROBRAS FPSO unit, covering: all equipment, materials, software, interconnection, documentation, configuration, tests, installation and training. These systems will be referred to along this specification as CCTV.

## 2. ABBREVIATIONS

ABNT	Associação Brasileira de Normas Técnicas (Brazilian Association of Technical Standards)
ANSI	American National Standards Institute
CCTV	Closed Circuit TV
CPU	Central Processing Unit
DIO	Distribuidor Interno Óptico (Optical Distribution Drawer)
EIA	Electronic Industries Alliance
FTP	Foil Shielding Twisted Pair
HD	High Definition
HDMI	High-Definition Multimedia Interface
IEC	International Electrotechnical Commission
INMETRO	Instituto Nacional de Metrologia (National Institute of Metrology)
IP	Internet Protocol / Ingress Protection
IR	Infra-Red
LAN	Local Area Network
LED	Light-Emitting Diode
LSZH	Low Smoke Zero Halogen
NVR	Network Video Recorder
ONVIF	Open Network Video Interface Forum
PTZ	Pan Tilt Zoom
PoE	Power over Ethernet
TIA	Telecommunications Industry Association
UPS	Uninterruptible Power Supply
UV	Ultraviolet
VLAN	Virtual Local Area Network
VMS	Video Management Software
WDR	Wide Dynamic Range

## 3. REFERENCE DOCUMENTS, CODES AND STANDARDS

- 3.1 The detailed design shall be made, at least, in accordance with requirements of those International and National Standards listed below:
- ABNT NBR 5410 – Instalações Elétricas de Baixa Tensão.
  - ANSI/EIA/TIA 568-B2-1 – Commercial Building Telecommunications Cabling Standard.
  - ANSI/EIA/TIA 568-C.2 – Balanced Twisted-Pair Cabling Components.

	<b>TECHNICAL SPECIFICATION</b>	<b>Nº: I-ET-3010.00-5514-76A-PPT-002</b>	<b>REV. D</b>
	<b>AREA:</b> -	<b>SHEET:</b> 4 of 19	
	<b>TITLE:</b>	<b>TOPSIDES CCTV SYSTEM</b>	<b>INTERNAL</b>
			<b>OI/CS</b>

- d. ANSI/EIA/TIA 568.3-D – Optical Fiber Cabling Components Standard.
- e. IEC 61892 – Mobile and fixed offshore units – Electrical installations – All Parts.
- f. IEC 60079 – Explosive Atmospheres – All Parts.
- g. IEC 60092 – Electrical installations in ships – All Parts;
- h. IEC 60228 – Conductors of insulated cables.
- i. IEC 60331 – Fire-resisting characteristics of electric cables (and its updates);
- j. IEC 60332 – Flame-retardant characteristics of electric cable (and its updates);
- k. IEC 62444 – Cable glands for electrical installations;
- l. IEC 60529 – Degrees of Protection Provided by Enclosures (IP Code);
- m. INMETRO/Portaria nº 115, March 21<sup>st</sup> 2022 and its annexes;
- n. NR-10 – Segurança em Instalações e Serviços em Eletricidade;
- o. NR-37 – Segurança e Saúde em Plataformas de Petróleo.

3.2 It shall be followed all others NR's – Normas Regulamentadoras (Regulatory Standards) from Ministério da Economia (Brazilian Ministry of Labor) applicable to this Technical Specification.

3.3 Electrical installations, equipment and materials shall comply with the requirements of IEC 60079, IEC 61892-1, IEC 61892-7 and Classification Society.

3.4 All equipment, installations and materials shall be of type approved and certified by international recognized laboratory and shall be in accordance with INMETRO Portaria nº 115, March 21<sup>st</sup> 2022 and its annexes.

3.5 Thermal cameras shall comply with the ordinance: Ministério da Defesa / Portaria nº 56 – COLOG, Jun 5th 2017, or any other updated one. Additionally, CONTRACTOR shall provide and submit all required forms filled in order to comply with Brazilian Army.

3.6 Classification Society

3.6.1. The detailed design shall be submitted to approval by Classification Society. The design and installation shall take in account their requirements and comments.

#### 4. GENERAL REQUIREMENTS

4.1 CONTRACTOR shall provide all the materials, equipment, accessories, cables and infrastructure that compose the CCTV system.

4.2 For PETROBRAS detailed design requirements, Installation, Configuration, Tests training and Commissioning CONTRACTOR shall comply with the DESCRIPTIVE MEMORANDUM I-MD-3010.00-5510-760-PPT-001 – GENERAL CRITERIA FOR TELECOMMUNICATIONS DESIGN.

	<b>TECHNICAL SPECIFICATION</b>	<b>Nº: I-ET-3010.00-5514-76A-PPT-002</b>	<b>REV. D</b>
	<b>AREA:</b> -	<b>SHEET:</b> 5 of 19	
	<b>TITLE:</b> <p style="text-align: center;"><b>TOPSIDES CCTV SYSTEM</b></p>	<b>INTERNAL</b>	<b>OI/CS</b>

- 4.3 For documentations symbols, the Detailed Design shall comply with the Technical Specification: I-ET-3000.00-0000-940-P4X-002 – SYMBOLS FOR PRODUCTION UNITS DESIGN.
- 4.4 For equipment TAGs, the Detailed Design shall comply with the Technical Specification: I-ET-3000.00-1200-940-P4X-001 – TAGGING PROCEDURE FOR PRODUCTION UNITS DESIGN and I-ET-3010.00-5140-700-P4X-005 - REQUIREMENTS FOR HUMAN ENGINEERING DESIGN FOR ELECTRICAL SYSTEMS OF OFFSHORE UNITS.
- 4.5 For infrastructure materials, accessories, cable trays cable ladder, the Detailed Design shall comply with the Technical Specification: I-ET-3010.00-5140-700-P4X-002 – SPECIFICATION FOR ELECTRICAL MATERIAL AND EQUIPMENT FOR OFFSHORE UNITS.
- 4.6 For the telecommunication data equipment specification, the Detailed Design shall comply with the Technical Specification: I-ET-3010.00-5517-768-PPT-006 – TOPSIDES DATA NETWORK.
- 4.7 For the cabling network used in the CCTV system, the Detailed Design shall comply with the Technical Specification: I-ET-3010.00-5517-768-PPT-004 - TOPSIDES STRUCTURED CABLING NETWORK.
- 4.8 Details about the CCTV System installed in the Hull can be found in the Technical Specification: I-ET-3010.00-5514-76A-PPT-001 – HULL CCTV SYSTEM.
- 4.9 Equipment and accessories shall attend the ingress protection degree, protection type, classifications zone and groups established by IEC / ABNT.
- 4.10 CONTRACTOR shall supply all equipment, cables and accessories approved and certificated by Classifying Society and technical conformity with the International and National standardization organism: ABNT, IEC and INMETRO.
- 4.11 Equipment and accessories installed in outdoor or industrial areas shall be suitably rugged and their external bodies shall be made in non-metallic material, suitable for harsh environments and in accordance with IEC and ABNT standards, apart from the ones whose classification area require to be metallic as Ex-d junction boxes.
- 4.12 Brackets, bolts, nuts, washers and any other mechanical fixing elements shall be made in stainless steel.
- 4.13 In case of difficulty for supplying some accessory with external body made with non-metallic materials, it will be necessary to submit them for analysis and approval of PETROBRAS.
- 4.14 It shall be avoided equipment and accessories with their external bodies built in aluminum alloy. Anything different shall be submitted to PETROBRAS approval. In case of approval, this alloy shall not contain in its composition more than 0.25 % of copper and shall comply with the ASTM-B-179 standard (ANSI alloy 356.1).

	<b>TECHNICAL SPECIFICATION</b>	<b>Nº: I-ET-3010.00-5514-76A-PPT-002</b>	<b>REV. D</b>
	AREA: -	SHEET: 6 of 19	
	TITLE:	<b>TOPSIDES CCTV SYSTEM</b>	

- 4.15 In outdoor areas, exposed to marine atmosphere, CONTRACTOR shall avoid the galvanic corrosion of junction boxes supports, horns supports and bolts. Galvanic insulation shall be implemented wherever contact between different metallic materials is needed.
- 4.16 Equipment and materials shall be supplied in package suitable for long periods of storage and be protected against mechanical impact and adverse weather conditions.
- 4.17 Equipment and materials shall be supplied and installed with all threads, hinges, bolts, cover plugs, cable glands and flanges lubricated with anti-seize (loctite) or similar grease.
- 4.18 Equipment and materials shall be supplied with cable passage holes sealed with plastic plugs in the holes to be used and definitive plugs (made of the same material as Equipment and accessories) in the reserve holes.
- 4.19 Electrical equipment installed in external (open) safe areas, foreseen to operating during emergency shutdown ESD-3 shall be certified for installation in hazardous areas Zone 2 Group IIA temperature T3, according to IEC 61892-1.
- 4.20 All external cameras shall be explosion proof, according with 6.1, even in places where there are no hazardous areas. This is because during an ESD-3 event they must remain operating. Then, they must be powered by uninterrupted electrical source.
- 4.21 Equipment shall have casing grounded. Grounding by simply supporting the casing on the steel structure of the FPSO shall not be deemed adequate.
- 4.22 The junction boxes and cameras shall have the cable glands installed facing lateral sides and/or bottom side. Cable glands installed facing upward are not acceptable. It is also not acceptable any opening facing the upward of the box, even if it is closed by cover plug.
- 4.23 In order to avoid humidity and water ingress inside the junction boxes, CONTRACTOR shall apply appropriate material in the screw thread, bolts, cable glands, cover plugs and joints, according to IEC 60079 and IEC 60529.
- 4.24 CONTRACTOR shall ensure by inspection of a qualified personnel that all equipment installations are according to the IEC/ABNT standards requested in this technical specification.
- 4.25 CONTRACTOR shall assure that all fixed external camera supports for fixing it, shall have azimuthal adjustable facilities, as illustrated in Figure 1:



Figure 1: Example of support with azimuthal adjust.

## 5. SYSTEM DEFINITIONS

- 5.1 All materials and equipment, including accessories and installation items shall be appropriated for its operation on offshore environment and in case of external installation appropriated IP grade protection and Ex protection shall be applied.
- 5.2 Equipment, cables, boxes, materials and accessories for installation in the industrial areas (outdoor or indoor) of unit shall be specified and assembled taking into account the adverse operating conditions on UNIT such as:
- Atmosphere with high content of humidity, salts hydrocarbons and other corrosive factors.
  - Environment subject to the presence of explosive gases shall be in accordance with Hazardous area classification.
  - Exposure to weather conditions (sun and rain) and maritime atmosphere.
  - Air temperature: from  $-10^{\circ}\text{C}$  up to  $+50^{\circ}\text{C}$ .
  - Air humidity: 95%.
- 5.3 The CCTV System shall be fed by the FPSO electrical system, power supply from the Emergency Loads distribution panel. Any PoE cameras shall be powered by switches, and they shall be powered by UPS panel through ATS device.
- 5.4 Standalone cameras or cameras interconnected to junction boxes shall be powered by UPS panel by means of AC switchboard (one circuit breaker for each junction box or standalone equipment) previously connected to a panel ATS device, which shall be connected to UPS bus A and UPS bus B as indicated represented in Topsides Telecommunications Energy System.
- 5.5 All cameras and its infrastructure installed in outdoor areas shall be explosion proof type and Zone 1 classification area.
- 5.6 Figure 2 presents a basic architecture of the system.

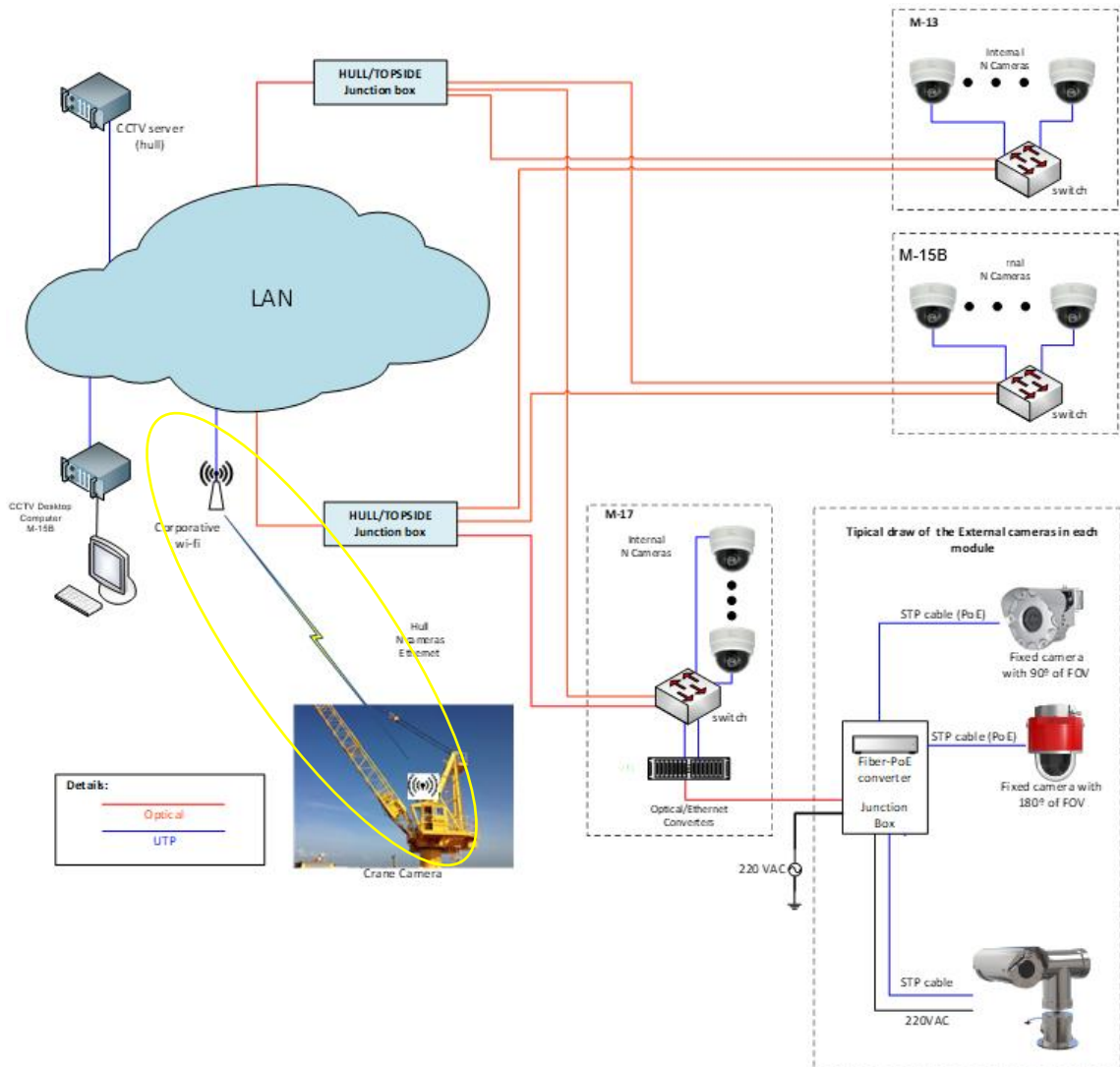



Figure 2 – Topside CCTV basic architecture. The topside CCTV cameras shall be integrated in the hull CCTV system. Crane camera shall be integrated using the available wi-fi system. This is an illustrative draw, quantities and devices can vary in each module.

- 5.7 Each module shall have a junction box for the adequate number of fibers cable and operational spares, media converters for active cameras and power supply. Each camera inside a module shall be connected to junction box in the respective module.
- 5.8 All the cameras in a module shall be powered using PoE, except the PTZ cameras, which shall be powered with 220 VAC.
- 5.9 For each PoE camera it shall be installed a fiber to PoE converter inside de junction box. There shall be a pair of fiber to use in each camera, and each pair of fiber shall be connected to an optical switch port in the telecommunication racks in modules or telecommunication rooms.
- 5.10 The cameras from the topside modules shall be connected to the Hull CCTV system. This connection shall be done using the available data network.
- 5.11 There will be a data network switch to connect the cameras in some Toppides modules according to I-ET-3010.00-5517-768-PPT-004 TOPSIDES STRUCTURED



	<b>TECHNICAL SPECIFICATION</b>	<b>Nº: I-ET-3010.00-5514-76A-PPT-002</b>	<b>REV. D</b>
	AREA: -	SHEET: 9 of 19	
	TITLE:	<b>TOPSIDES CCTV SYSTEM</b>	INTERNAL
OI/CS			

CABLING NETWORK and I-ET-3010.00-5517-768-PPT-006 TOPSIDES DATA NETWORK.

- 5.12 For distances up to 90m from the rack in the telecommunication room or junction box in each module, video and power (PoE) shall be transmitted using metallic twisted pair cable, cat.6 LSZH with UV protection and also protection against electromagnetic interferences (shielded or foiled).
- 5.13 A grounded surge protection shall be installed in the power supply for each external camera.
- 5.14 For external cameras using shielded twisted pair cable, a grounded surge protector shall be installed in the twisted pair cable.
- 5.15 Junction boxes shall not be installed in areas where they would be exposed to the weather. If that installation is necessary, junction boxes suitable for the purpose and built with necessary Ingress Protection degree shall be used.
- 5.16 All grounding bus bars shall be of thin-plated copper and painted with green strips.
- 5.17 Connections to the grounding network for equipment and boxes shall be made by means of bolted terminals.
- 5.18 All external cameras shall be grounded.

**5.19 System Configuration**

- 5.19.1. All equipment: CCTV desktop computer, network devices, access points and cameras shall be configured by CONTRACTOR to integrate to the HULL CCTV system, according to CCTV Technical Instruction, to be provided by PETROBRAS at the time of the system configuration.
- 5.19.2. Camera selection and positioning in preset positions (pre-positioning or further “preset functions”) shall be configured.
- 5.19.3. Digital video recording facilities shall be configured.
- 5.19.4. IP ADDRESS – All manageable devices: cameras, CCTV desktop computers, shall be addressed at specific VLAN IP address ranges provided by PETROBRAS during the Commissioning phase.

	TECHNICAL SPECIFICATION	Nº:	I-ET-3010.00-5514-76A-PPT-002	REV.	D	
	AREA:	-			SHEET:	10 of 19
	TITLE:	TOPSIDES CCTV SYSTEM			INTERNAL	OI/CS

## 6. TECHNICAL REQUIREMENTS

### 6.1 CAMERAS

#### 6.1.1. General Characteristics:

- a. They all shall be IP cameras.
- b. All cameras shall be fully compatible with the VMS Security Center of Genetec and recognized by their support and maintenance. Genetec SDL (Supported Device List) will be utilized to check the offered products. It will not be accepted cameras, or other devices, that are not listed on Genetec Supported Device List. or presented with a Genetec declaration in cases where the camera model is new and is not still available in SDL
- c. All cameras should not be in "end of sale", "end of life" or any other equivalent status of a discontinuity process in the manufacture's web site.
- d. They shall be compatible with the VMS software through the ONVIF Profile S protocol.
- e. H.264 or H.265 codification.
- f. Resolution: the resolution requested for each type of camera must be met, and a camera with a higher resolution may be offered
- g. WDR, white compensation and automatic IR cut filter for day & night operation.
- h. Automatic focus adjustment, except for fixed lens models.
- i. They shall allow two configurable independent streams profiles (a mainstream profile for Live and Recording view, and a sub stream profile for Remote view) both in the native camera manufacture protocol and via ONVIF Profile S protocol.
- j. Password protection for Web viewing and configuration.
- k. All cameras must be activated with the latest firmware version installed.
- l. 5 years manufacturer's warranty. This minimum warranty period must be expressed in the manufacturer's datasheet (or other document) or may be in letter format referencing the bidding process.
- m. If it is not possible to propose a model that meets the stipulated requirements, it is possible to use equipment with superior performance, which includes the requirement in its service.

#### 6.1.2. Fixed IP Camera with Dome

- a. Full HD resolution (minimum), @30 fps.
- b. Suitable for indoor use.
- c. PoE powered.
- d. Lens: Fixed, with a minimum horizontal aperture of 90 degrees (it can be varifocal, if a minimum horizontal aperture of 90 degrees is ensured at the shortest focal length).

<b>TECHNICAL SPECIFICATION</b>		Nº: <b>I-ET-3010.00-5514-76A-PPT-002</b>	REV. <b>D</b>
AREA: -		SHEET: 11 of 19	
TITLE: <b>TOPSIDES CCTV SYSTEM</b>		INTERNAL	
		OI/CS	

- e. Infrared LED with minimum range of 20m.

#### 6.1.3. Explosion-Proof PTZ IP Camera

- a. Certified for hazardous areas, Zone-1, Ex-d, IIB, T4 and in accordance with INMETRO 115/2022.
- b. Full HD resolution (minimum), @30 fps.
- c. Input Power: 220 VAC-UPS.
- d. Varifocal lens with minimum zoom range of 30x.
- e. Operating temperature -10°C to + 50°C.
- f. Minimum protection: IP 66.
- g. Pan - Tilt: 360° and ± 90° or equivalent.
- h. Presets: minimum 32.

#### 6.1.4. Explosion-Proof Fixed IP Camera

- a. Certified for hazardous areas, Zone-1, Ex-d, IIB, T4 and in accordance with INMETRO 115/2022.
- b. Additionally, as per CCTV one line diagram, for Battery Room, camera specification shall attend hazardous areas, Zone-1, Ex-d, IIB+H2, T4 and in accordance with INMETRO 115/2022
- c. Full HD resolution (minimum), @30fps.
- d. Input Power: 220 VAC-UPS.
- e. Varifocal lens.
- f. Minimum horizontal viewing angle  $\geq 90^\circ$  for IIB gas category cameras and  $\geq 60^\circ$  for IIB+H2 gas category cameras (Battery Room).
- g. Operating temperature -10°C to + 50°C.
- h. Minimum protection IP 66.

#### 6.1.5. Explosion-Proof Fixed Panoramic IP Camera with Dome (180° field of view)

- a. Certified for hazardous areas, Zone-1, Ex-d, IIB, T4 and in accordance with INMETRO 115/2022.
- b. Additionally, as per CCTV one line diagram, for Battery Room, camera specification shall attend hazardous areas, Zone-1, Ex-d, IIB+H2, T4 and in accordance with INMETRO 115/2022.
- c. Multisensor camera, with 4 sensors, composing a unique panoramic video stream image, allowing a horizontal viewing angle of 180° coverage (minimum).
- d. Minimum vertical viewing angle  $\geq 50^\circ$ , per sensor.

	<b>TECHNICAL SPECIFICATION</b>	<b>Nº: I-ET-3010.00-5514-76A-PPT-002</b>	<b>REV. D</b>
	<b>AREA:</b> -	<b>SHEET:</b> 12 of 19	
	<b>TITLE:</b> <p style="text-align: center;"><b>TOPSIDES CCTV SYSTEM</b></p>		<b>INTERNAL</b>
			<b>OI/CS</b>

- e. 7,3 Mpixel resolution (minimum), @30 fps, for the composed image.
- f. PoE powered.

## 6.2 Explosion-Proof Camera Junction Box

- a. Certified for hazardous areas, Zone-1, Ex-d, IIB and in accordance with INMETRO 115/2022.
- b. The interconnection between the data cabling cabinets and the junction boxes shall be done by means of multi-cables containing power supply wires and fiber optic (distance greater than 90m) or by shielded UTP (distances less than 90m).
- c. If CONTRACTOR has a camera solution in compliance with all the specifications without the need of a junction box, it shall be submitted to PETROBRAS approval before installation.
- d. The junction box shall be suitable for explosive atmosphere use in saline environment.
- e. Material: 316 stainless steel.
- f. The cover shall be fixed with 316 stainless steel screws.
- g. The Junction Box shall be certified according to equipment to be installed inside it. It will be not acceptable the certification for the empty Junction Box.

## 6.3 Camera Dome Cleaner

- a. Indoor/outdoor camera lens cleaner.
- b. It shall clean the lens of dome cameras, as well as flat lenses cameras.
- c. It shall be constructed as a no longer than 02 (two) meters carbon fiber or aluminum extension pole that extends to 8 (eight) meters.
- d. At the end of the pole, a head shall be assembled, and it shall be covered with a soft microfiber mitt that involve the camera dome and clean it.
- e. The head of the pole must be made up of reinforced fins, so that they exert a force to the center, so that there is a pressure of the microfiber mitt on a dome of a camera.
- f. The microfiber mitt shall be removable, allowing washing it.
- g. It shall be delivered with three microfiber mitts and two bottle of lens cleaning solution.

## 6.4 Ethernet-PoE/Optical Multimode Converter - Standalone

- a. Electrical Interface - 100/1000BASE-TX 8P8C (RJ-45) with IEEE 802.3bt PoE (with power injector that shall be able to be enabled or disabled by a switch).

<b>TECHNICAL SPECIFICATION</b>	Nº: <b>I-ET-3010.00-5514-76A-PPT-002</b>	REV. <b>D</b>
AREA: -	SHEET: 13 of 19	
TITLE: <b>TOPSIDES CCTV SYSTEM</b>		INTERNAL
		O/CS

- b. Optical interface - Multimode G.651.
- c. Core diameter - 50µm.
- d. Standard - 100/1000BASE-FX SC-PC.
- e. Number of fibers - 2 fibers.
- f. Installation - standalone box.
- g. Connector – SC.
- h. Operating temperature -10°C to + 50°C.
- i. Power Source: 220VAC.
- j. Link failure pass-through.
- k. Auto MDI / MDI-X for TX port.

#### **6.5 Ethernet/Optical Converter Sub-Rack**

- a. Assemble type – 19” rack.
- b. Power Source: 220VAC.
- c. Number of channels: min. 10.
- d. Connector – SC.
- e. Network Interface: RJ-45 100/1000Base T compatible.

#### **6.6 Ethernet/Optical Multimode Converter – Sub-rack card**

- a. The card-type module shall be "hot swappable", so its insertion or withdrawal shall not interfere with the other modules installed in the same sub-rack. This model is allowed only in the telecommunication room.
- b. Electrical Interface – 100/1000BASE-TX 8P8C (RJ-45).
- c. Optical Interface - Multimode G.651.
- d. Core Diameter - 50µm.
- e. Standard – 100/1000BASE-FX.
- f. Number of fibers - 2 fibers.
- g. Installations – sub-rack 19” slot.
- h. Connector – SC.

#### **6.7 Electrical Surge Protector**

- a. Category - IEC II / C.
- b. Nominal voltage Phase / ground - 127 VAC ~ 220 VAC.

<b>TECHNICAL SPECIFICATION</b>	Nº: <b>I-ET-3010.00-5514-76A-PPT-002</b>	REV. <b>D</b>
AREA: -	SHEET: 14 of 19	
TITLE: <b>TOPSIDES CCTV SYSTEM</b>		INTERNAL
		OI/CS

- c. Reference voltage at 1 mAcc - 430 Vcc.
- d. I<sub>max</sub>. – Max. current - 40 kA.
- e. Max. Residual voltage at 300 A - 710V.
- f. Response time /Varistor - < 25 ns.
- g. Response Time - < 30 ns.
- h. Fail alarm – LED.
- i. Standard compliance: IEC 61643-21.

### **6.8 Ethernet PoE Surge Protection**

- a. Interface: 100/1000BASE-TX 802.3at.
- b. Connector (in/ out): ethernet RJ45, Cat6.
- c. Response time < 10ns.
- d. Standard compliance: IEC 61643-21.

### **6.9 External Cat.6 Twisted Pair Cable**

- a. Cable shall be LSZH class compliance, according to ABNT NBR 14705.
- b. The cable shall be suitable for industrial saline environment, being resistant to UV radiation.
- c. It shall be compliance with Cat 6 standard.
- d. Cable shall have an electromagnetic protection (shielded or foiled).

### **6.10 DIO for Cameras**

- a. DIO to 24 (twenty-four) fibers. Articulated drawer type, steel frame, 19 "rack mounting standard, epoxy paint.
- b. Equipped with optical cable assembling kit, fusion splice protectors, 1.5 m internal optical pigtails and protectors, and organizer for all DIO fibers.
- c. All pig tails and adapters shall be terminated in a SC connector.

### **6.11 Fiber Optic Patch Cord**

- a. Optical cable composed of an optical fiber, with a primary coating of acrylate and secondary of PVC, and over them a non-flame propagating PVC cover.
- b. The connectors shall be compatible with equipment and DIOs.

<b>TECHNICAL SPECIFICATION</b>	Nº: <b>I-ET-3010.00-5514-76A-PPT-002</b>	REV. <b>D</b>
AREA: -	SHEET: 15 of 19	
TITLE: <b>TOPSIDES CCTV SYSTEM</b>		INTERNAL
		OI/CS

- c. The polishing of the connectors shall be PC type.
- d. The optical cords shall have ANATEL certification and meet the ABNT standards NBR 14433 e ABNT NBR 14106.
- e. The fiber optic patch cord shall be in OM-4 standard color.

### 6.12 STP or FTP Category 6 Cabling

- a. Cable of twisted pair (STP or FTP) shall attend the standards and composed for 04 (four) equal, 24 AWG, 100 Ohms, rigid copper drivers with isolation in high density polyethylene, with electric and mechanics characteristics compatible with the established patterns and tested up to 1 GHz. It shall have a cover fire retardant type LSZH.
- b. The Cables STP or FTP CAT 6 shall possess the UL Register and Certification via Laboratory of international recognition for parameters that attend the Standards.
- c. All the necessary accessories for installing the CAT6 cabling shall be foreseen in the project and supplied by CONTRACTOR.
- d. All the STP or FTP cables shall be identified in its both extremities, using polyester labels printed mechanically in an indelible way. In the same way shall be identified all the other components of the network as: Patch Panel, fiber optic cables, Patch Cords and Sockets.
- e. The organization of the cables inside the racks shall use only velcro. On cable trays the cabling shall be tied with black plastic tie wraps.

### 6.13 Multimode Optical Fiber Cable

- a. The network point where there is a technical non viability of service for cable FTP due to the access characteristics (distance), it shall be assisted by multimode optical fiber cable type OM-4 of 50 µm x 125 µm, according to ANSI/TIA-568.3-D, ISO/IEC 11801 and ITU-T G651.
- b. The employed optical cables shall be of tight buffered type, fully waterproof, longitudinally and radially, constituted by fiber optic with primary covering in acrylic and secondary covering in material colored polymer, gathered and covered by dielectric synthetic fibers for mechanical support (resistance to the traction). Covered by an external layer of special polymeric for external use with protection UV and fire-retardant type LSZH.
- c. The optical cables coming from the operational area will be finished in DIO pattern 19 inches of 24 positions with SC-PC connectors on the Structured Network Racks.

<b>TECHNICAL SPECIFICATION</b>	Nº: <b>I-ET-3010.00-5514-76A-PPT-002</b>	REV. <b>D</b>
AREA: -	SHEET: 16 of 19	
TITLE: <b>TOPSIDES CCTV SYSTEM</b>		INTERNAL
		OI/CS

- d. Whenever a single Junction Box is due to be assisted by single fiber optic cable, this cable shall have at least 04 (four) extra fibers (02 pairs), for future use, fully ended on DIO position with SC-PC interfaces at both ends with the adequate characteristics for the area to be applied, beyond the fibers used by the active cameras connected to the junction box.
- e. At the DIO shall be used an optical extending multimode (MM) of 50 µm x 125 µm with SC-PC / SC-PC connectors in OM-4 standard color.
- f. The interconnection of DIO with the active elements of network shall be used optical multimode patch cords (MM) of 50 x 125µm in the OM-4 standard color and SC-PC / LC-PC connectors. It shall be foreseen by the CONTRACTOR the supply of an excess of 30% for this item for future expansion and spare.

#### **6.14 Patch Cord RJ-45 Cat 6**

- a. Patch Cords category 6/Class E shall be finished in factory with connector RJ-45 male, with plastic layer (boot) inserted in the connector to relieve the tensions and to avoid the accidental disconnection. They shall be built with flexible UTP 24 AWG cable. Each patch cord shall have its whole performance 100% tested in factory regarding the Cat. 6 of the standard ANSI/TIA/EIA 568-C-2.
- b. The outer sheath owes being of fire-retardant type and LSZH, with demarcation of indelible length.
- c. Patch cord shall present acting values in the center of the strip of the values (center tuned) certain for the norm ANSI/TIA/EIA-568B2-1 for NEXT.

#### **6.15 Patch Panel Cat 6**

- a. Patch Panel shall be metallic with width of 19 inches according to norm ANSI/TIA/EIA-310D, with 24 connectors type RJ-45 female and 1 U of height.
- b. It shall have a cables guide (bar) in back for supporting and fastening of cables.
- c. It shall still execute the specifications of components Category 6 /Class E ANSI/TIA/EIA 568-C.2 (component compliance).
- d. The modules shall have structure built in plastic of high impact, fire retardant type called UL 94V-0. The circuits printed papers shall totally be contained inside the patch panel, in other words, the panel shall contain protection for the circuits printed, avoiding damages to the same ones during the connectors installing process.



<b>TECHNICAL SPECIFICATION</b>	Nº: <b>I-ET-3010.00-5514-76A-PPT-002</b>	REV. <b>D</b>
AREA: -	SHEET: 17 of 19	
TITLE: <b>TOPSIDES CCTV SYSTEM</b>		INTERNAL
		OI/CS

### **6.16 Operator CCTV Desktop Computer**

- a. CPU and memory capacity in accordance with Genetec system requirements, considering at least 06 (six) full HD images, @ H.264 / H.265 (according to the encoding format of the provided cameras).
- b. They shall have a dedicated graphics card with at least 2G of memory and at least 02 (two) video monitor output option.
- c. CCTV Desktop computer shall have Windows 11 Professional (64 bits).

### **6.17 TV Monitor**

- a. Shall have at least 46" size with 1920 x 1080 pixels minimal resolution.
- b. Thin borders and symmetricals, maximum 5.5 mm bezel-to-bezel.
- c. Contrast ratio 5000:1 or more.
- d. Video input HDMI.
- e. Response time less than 8ms.
- f. VESA support.

### **6.18 Other construction and configuration requirements**

- a. All EX cameras must be industry standard models. Cameras mounted by CONTRACTOR (common camera + generic EX enclosure) will not be accepted, even if certified.
- b. All cameras shall have manufacturer warranty of at least 3 years.

## **7. SCOPE OF SUPPLY**

7.1 CONTRACTOR shall be responsible for the entire CCTV package which shall cover: design, engineering, manufacturing, equipment supply, install, testing, commissioning and all documentation according to this technical specification.

7.2 All material, equipment and installation services shall be concerning the following activities.

- a. Project for the CCTV system to be installed.

	<b>TECHNICAL SPECIFICATION</b>	Nº: <b>I-ET-3010.00-5514-76A-PPT-002</b>	REV. <b>D</b>
	AREA:	SHEET: 18 of 19	
	TITLE:	<b>TOPSIDES CCTV SYSTEM</b>	

- b. Supply of installation materials and equipment.
- c. Materials and installations of all equipment.
- d. Materials and installation of cabling and connectors.
- e. Tests and Certification of the whole installed CCTV network and fiber cabling.
- f. Physical identification of all components of system.
- g. Technical documentation of the System.

7.3 Cameras shall be supplied and installed, at minimum, according to TOPSIDES CCTV ONE LINE DIAGRAM.

7.3.1. The location of the cameras in each area are described in each respective arrangement drawings.

7.3.2. The final location, height, quantity and type of enclosure of the cameras shall be confirmed and PETROBRAS approved at Detailed Design phase.

7.3.3. Power supply for internal IP cameras shall be PoE.

7.4 One CCTV desktop computer with a 46" monitor shall be installed and configured at the Operator's Room Office at the Topsides, on the wall, according to TOPSIDES CCTV SYSTEM ONE LINE DIAGRAM.

7.5 It shall be supplied 02 (two) set of Camera Dome Cleaner.

## 8. DIMENSIONING CRITERIA

8.1 The number of cameras and their types have already been defined in the Basic Project.

8.2 Basic CCTV one line diagram and basic CCTV overall arrangement of cameras shall be used which local shall be confirmed by PETROBRAS during Detail Design.

8.3 PETROBRAS Operational and Engineering Team shall approve the final camera's location according to 3D viewed screen to be presented.

8.4 The amount and size of NVR HD's shall consider the premises of I-ET-3010.00-5514-76A-PPT-001, item 6.2.

8.5 In case of existing an inert gas generator room in the topside modules, in accordance with Classification Society, it shall be installed one Explosion-Proof Fixed IP Camera in each room.

## 9. COMMISSIONING

	<b>TECHNICAL SPECIFICATION</b>	Nº: <b>I-ET-3010.00-5514-76A-PPT-002</b>	REV. <b>D</b>
	AREA:	SHEET:	
	TITLE:	19 of 19	
	<b>TOPSIDES CCTV SYSTEM</b>		INTERNAL
			OI/CS

- 9.1 The Tests and Certification of the CCTV network shall comply with the Technical Specification I-ET-3010.00-5510-760-PPT-002 BASIC CRITERIA FOR TELECOM DESIGN which is summarized bellow.
- 9.2 The horizontal network of Metallic Cables (STP or FTP) shall be certified according to Standard ANSI/EIA/TIA requirements 568-B2-1 CAT 6 /Class E.
- 9.3 Preferentially, Fluke certification instrument DTX Cable Analyzer model 1800 or more recent and better model shall be used.
- 9.4 The network of optical cables shall be certified according to Standard ANSI/EIA/TIA'S requirements 568-3D CAT 6/Class E for optical backbones.
- 9.5 Preferentially, the instrument of certification of Fluke DTX Cable shall be used Analyzer model 1800 or more recent model.
- 9.6 It can be used the OTDR network analyzer to ensure the network connectivity and test network configuration.
- 9.7 CONTRACTOR shall present certification tests CAT 6 report for all the installed points, in magnetic media, compatible with the Software of Fluke Link Ware.
- 9.8 All the instruments to be used shall be accompanied by the Certificate of Calibration that shall be inside its period of validity. The Certificate shall be presented before the beginning of the tests and an authenticated copy of the original shall proceed enclosed the documentation to be given at the end of the work.

## **10. CRANE CAMERA INTEGRATION WITH THE HULL CCTV SYSTEM**

- 10.1 Crane camera presented on I-ET-3010.00-5266-631-P4X-001 and its Data Sheet Basic Project document shall be integrated to the Hull CCTV system using the available Wi-Fi system.
- 10.2 The crane CCTV system shall connect with Hull CCTV system by Wi-Fi.
- 10.3 The crane CCTV system shall be standalone and operate separated from the Hull CCTV system. Only the image from the camera shall be shared between the systems.