	TECHNICAL SPECIFICATION	Nº: I-ET-3010.00-5518-767-PPT-001
	CLIENT: SRGE	SHEET: 1 of 38
	JOB: PUBLIC ADDRESS AND GENERAL ALARM (PAGA)	
	AREA: -	
TIC	TITLE: HULL PUBLIC ADDRESS SYSTEM	INTERNAL OI/CS

MICROSOFT WORD / V.2016 / I-ET-3010.00-5518-767-PPT-001_C.docx

INDEX OF REVISIONS

REV.	DESCRIPTION AND/OR REVISED SHEETS
0	ORIGINAL ISSUE
A	REVISED WHERE INDICATED
B	REVISED WHERE INDICATED
C	INCLUDED ITEM 4.3, 6.4.5, 5.1.10.3,

	REV. 0	REV. A	REV. B	REV. C	REV. D	REV. E	REV. F	REV. G	REV. H
DATE	ABR/01/22	OCT/25/2022	NOV/10/2022	JUL/08/2024					
DESIGN	PROJ-US	PROJ-US	PROJ-US	PROJ-US					
EXECUTION	Y3S7	Y3S7	Y3S7	Y3S7					
CHECK	CY22	CY22	CY22	CY22					
APPROVAL	X187	X187	X187	X187					

INFORMATION IN THIS DOCUMENT IS PROPERTY OF PETROBRAS, BEING PROHIBITED OUTSIDE OF THEIR PURPOSE
 FORM OWNED TO PETROBRAS N-0381 REV. L



TECHNICAL SPECIFICATION	Nº: I-ET-3010.00-5570-767-PPT-001	REV. C
AREA: -	SHEET: 2 of 38	
TITLE: HULL PUBLIC ADDRESS SYSTEM	INTERNAL	
	O/CS	

INDEX

1. SUBJECT	3
2. ABBREVIATIONS.....	3
3. REFERENCE DOCUMENTS, CODES AND STANDARDS	4
4. GENERAL REQUIREMENTS	5
5. SYSTEM DEFINITIONS.....	12
6. TECHNICAL REQUIREMENTS	16
7. SCOPE OF SUPPLY.....	26
8. DIMENSIONING CRITERIA	33
9. COMMISSIONING	37

1. SUBJECT

- 1.1 The subject of this document is to establish the criteria and basic characteristics for the detail design, supply and installation of Public Address and General Alarm System (PAGA) that shall be installed in PETROBRAS FPSO Unit.
- 1.2 The PAGA System is intended to provide, with prioritized selective diffusion of public announcements, calls, alarms and warning messages by sound transducers network suitably distributed around the PETROBRAS FPSO Unit, which includes Hull areas, Accommodation Module and Topsides area. The topsides area is out of this scope of this technical specification, but CONTRACTOR shall design and implement interface boxes outside of Accommodation Modules and nearby to Pipe rack Module.

2. ABBREVIATIONS

ABNT	Associação Brasileira De Normas Técnicas (Brazilian Association of Technical Standards)
ACU	Access Control Unit
AFT	Ceiling Loudspeaker
ANSI	American National Standards Institute
AMP	Audio Amplifier
CA	Alarms Command Switch (Abandon, Emergency and Reset)
CAC	Acoustic Box
CDI	Intercommunication Distributor Box
CIT	Public Address and General Alarms Central Station
CJE	Electrical Junction Box
CJI	Intercommunication Junction Box
CJS	Connection Box
COR	Acoustic Horn
CTA	Alarms Tone Generator
DGI	General Intercommunication Distributor
DPC	Departamento de Portos e Costas (Department of Ports and Coasts)
AU	Access Unit
EPR	Ethyl-Propylene Rubber
FAI	Internal Power Supply for Public Address Station
GT	Tests Tone Generator
IEC	International Electrotechnical Commission
IMO	International Maritime Organization
INMETRO	Instituto Nacional de Metrologia (National Institute of Metrology)
LSE	Emergency Lamp
LSZH	Low Smoke Zero Halogen
MA	Amplification Monitor
MCT	Multi Cable Transit
MDF	Main Distribution Board

TECHNICAL SPECIFICATION	Nº: I-ET-3010.00-5570-767-PPT-001	REV. C
AREA:	-	SHEET: 4 of 38
TITLE:	HULL PUBLIC ADDRESS SYSTEM	
		INTERNAL
		OI/CS

NBR	Norma Brasileira (Brazilian Standard)
NORMAN	Normas da Autoridade Marítima (Maritime Authority Standards)
NR	Norma Regulamentadora (Regulatory Standard)
PAGA	Public Address and General Alarm System
SCR	Petrobras Remote Control Room (Sala de Controle Remoto)
SOLAS	Safety Of Life At Sea
TP	Priority Microphone
XLPE	Crosslinked Polyethylene

3. REFERENCE DOCUMENTS, CODES AND STANDARDS

3.1 The detailed design shall be made, at least, in accordance with requirements of those International and National Standards listed below:

- a. ABNT NBR 5410 – Instalações Elétricas de Baixa Tensão.
- b. NR-10 – Segurança em Instalações e Serviços em Eletricidade.
- c. NR-37 – Segurança e Saúde em Plataformas de Petróleo.
- d. INMETRO/Portaria nº 115, March 21st 2022 and its annexes.
- e. DPC/NORMAM 201 – Normas da Autoridade Marítima para Embarcações Empregadas na Navegação em Mar Aberto.
- f. IEC 61892 – Mobile and fixed offshore units – Electrical installations – All Parts.
- g. IEC 60079 – Explosive Atmospheres – All Parts.
- h. IEC 60092 – Electrical installations in ships – All Parts.
- i. IEC 60331 – Fire-resisting characteristics of electric cables.
- j. IEC 60332 – Flame-retardant characteristics of electric cables
- k. IEC 62444 – Cable glands for electrical installations..
- l. IEC 60228 – Conductors of insulated cables.
- m. IEC 60529 – Degrees of Protection Provided by Enclosures (IP Code).
- n. IEC 60268-16:2011 - Objective rating of speech intelligibility by speech transmission index.
- o. IMO/LSA-Code – International Lifesaving appliance Code (MSC.48(66)).
- p. IMO/SOLAS Consolidated Edition 2014, or later.
- q. IMO – A 26/Res.1021 – 2009 – Code on Alerts and Indicators.
- r. ISO 9613-1 - Acoustics - Attenuation of sound during propagation outdoors - Calculation of the absorption of sound by the atmosphere.
- s. ISO 9613-2 - Acoustics - Attenuation of sound during propagation outdoors - General method of calculation.
- t. ISO 17534-1 - Acoustics — Software for the calculation of sound outdoors - Part 1: Quality requirements and quality assurance.

	TECHNICAL SPECIFICATION	Nº: I-ET-3010.00-5570-767-PPT-001	REV. C
	AREA: -	SHEET: 5 of 38	
	TITLE:	HULL PUBLIC ADDRESS SYSTEM	
			INTERNAL OI/CS

- u. ISO 17534-2 - Acoustics — Software for the calculation of sound outdoors - Part 2: General recommendations for test cases and quality assurance interface.
- v. ISO/TR 17534-3 - Acoustics — Software for the calculation of sound outdoors — Part 3: Recommendations for quality assured implementation of ISO 9613-2 in software according to ISO 17534-1.
- w. ANSI/EIA/TIA 568-C.2 – Balanced Twisted-Pair Cabling Components.
- x. ANSI/TIA-568.3-D – Optical Fiber Cabling Components Standard.

3.2 Electrical installations, equipment and materials shall comply with the requirements of IEC 60079, IEC 61892-1, IEC 61892-7 and Classification Society.

3.3 All equipment, installations and materials shall be of type approved and certified by international recognized laboratory and shall be in accordance with INMETRO Portaria nº 115, March 21st 2022 and its annexes.

3.4 In addition, it shall be followed all other NR's – Normas Regulamentadoras (Regulatory Standards) of Ministério do Trabalho (Brazilian Ministry of Labor) applicable to this Technical Specification.

3.5 Classification Society

3.5.1. The detailed design shall be submitted to approval by Classification Society. The design and installation shall take into account their requirements and comments.

4. GENERAL REQUIREMENTS

4.1 CONTRACTOR shall provide all the materials to install all equipment, accessories, cables and infrastructure that compose the Public Address and General Alarm System (PAGA).

4.2 The Public Address and General Alarm System (PAGA) shall be duplicated and be composed by System A installed in Telecom Upper Room at Accommodation Module and System B installed in Telecom Lower Room at Accommodation Module.

4.3 The distribution of loudspeakers must ensure overlapping coverage so that announcements and alarms are clearly understood if one of the systems fails. Under normal conditions, both systems must be operating synchronously, including the reproduction of voice and alarm announcements.

4.4 PAGA system A and B of HULL scope shall be dimensioned to feed all loudspeakers of all FPSO including HULL and TOPSIDE modules.

4.5 All LSE installed in topside modules shall be connected in PAGA system A and B installed in HULL scope.

	TECHNICAL SPECIFICATION	Nº: I-ET-3010.00-5570-767-PPT-001	REV. C
	AREA: -	SHEET: 6 of 38	
	TITLE:	INTERNAL	
	HULL PUBLIC ADDRESS SYSTEM		OI/CS

- 4.6 For PETROBRAS detailed design requirements, Installation, Configuration, Tests training and Commissioning CONTRACTOR shall be complied with the DESCRIPTIVE MEMORANDUM I-MD-3010.00-5510-760-PPT-001 – GENERAL CRITERIA FOR TELECOMMUNICATIONS DESIGN.
- 4.7 This following document defines general technical terms in order to equalize understanding of all design documents: I-ET-3010.00-1200-940-P4X-002 - GENERAL TECHNICAL TERMS.
- 4.8 For telecommunications symbols, the Detailed Design shall comply with the Technical Specification: I-ET-3000.00-0000-940-P4X-002 – SYMBOLS FOR PRODUCTION UNITS DESIGN.
- 4.9 For telecommunications TAGs, the Detailed Design shall comply with the Technical Specification: I-ET-3000.00-1200-940-P4X-001 – TAGGING PROCEDURE FOR PRODUCTION UNITS DESIGN.
- 4.10 All electrical requirements for telecom package shall be in accordance with I-ET-3010.00-5140-700-P4X-003 – ELETRICAL REQUIREMENTS FOR PACKAGES FOR OFFSHORE, I-ET-3010.00-5140-700-P4X-001 - SPECIFICATION FOR ELECTRICAL DESIGN FOR OFFSHORE UNITS, I-DE-3010.00-5140-700-P4X-003 - GROUNDING INSTALLATION TYPICAL DETAILS and I-ET-3010.00-5140-700-P4X-005 - REQUIREMENTS FOR HUMAN ENGINEERING DESIGN FOR ELECTRICAL SYSTEMS OF OFFSHORE UNITS.
- 4.11 Equipment and accessories shall attend the ingress protection degree, protection type, classifications zone and groups established by IEC / ABNT.
- 4.12 CONTRACTOR shall supply all equipment, cables and accessories approved and certificated by Classification Society and in technical conformity with the International and National standardization organism: ABNT, IEC and INMETRO.
- 4.13 All equipment, cables, accessories shall have Classification Society TYPE APPROVAL.
- 4.14 The Access Panel Unit shall generate only public announcements. They do not need to intercommunicate between each other, under Classification Society approval.
- 4.15 The PAGA system shall also be able to make public announcements generated by the telephone sets (TEL) using the Telephone System.
- 4.16 The Public Address and General Alarm System (PAGA) shall have interface with the following systems:
- 4.16.1. CSS-HFGS: PAGA system shall be automatically activated by the Hull Fire and Gas System (HFGS), which is part of the Control and Safety System (CSS) of the FPSO. CSS-HFGS will forward signals from the Emergency Panel to PAGA in order to broadcast sound emergency alarms.

TECHNICAL SPECIFICATION	Nº: I-ET-3010.00-5570-767-PPT-001	REV. C
AREA: -	SHEET: 7 of 38	
TITLE: HULL PUBLIC ADDRESS SYSTEM		INTERNAL
		OI/CS

- 4.16.2. CSS-HFGS will also send signals in order to inhibit the PAGA battery chargers in case of hydrogen detection and ventilation failure in the battery's rooms.
- 4.16.3. TVRO and Entertainment System: PAGA system shall automatically activate mute functionality at IPTV Entertainment System under PAGA alarm or priority announcements messages.
- 4.16.4. Telephony System: PAGA system shall have an interface with telephony system for public announcements messages.
- 4.16.5. Interface with the Topsides: it shall be provided all requirements to extend the PAGA System (System A and System B) to Topsides across appropriate interface boxes installed on Main Deck or in other location close to Pipe Rack:
- a. Number of dedicated amplifiers.
 - b. The audio lines of these power amplifiers shall connect the PAGA rack in the telecommunications rooms to an interface box located in a place that will be defined during the detailed design (Main Deck or close to Pipe Rack).
 - c. It shall be foreseen interface boxes located in place that will be defined during the detailed design (Main Deck or close to Pipe Rack), to connect the Emergency Signaling Lamps (LSE) lines from PAGA System to Topsides LSE Network.
 - d. It shall be foreseen interface boxes located in place that will be defined during the detailed design (Main Deck or close to Pipe Rack). Those boxes shall be responsible to connect the ACCESS UNIT lines and audio lines from PAGA system to the topsides ACCESS UNIT network and sound transducers distribution network.
- 4.17 The DC Power Supply of this system is scope of this technical specification.
- 4.18 Equipment and accessories installed in outdoor or industrial areas shall be suitably rugged and their external bodies shall be made in non-metallic material, suitable for harsh environments and in accordance with IEC and ABNT standards, apart from the ones whose classification area require to be metallic as Ex-d junction boxes.
- 4.19 In case of difficulty for supplying some accessory with external body made with non-metallic materials, it will be necessary to submit them for analysis and approval of PETROBRAS.
- 4.20 It shall be avoided equipment and accessories with their external bodies built in aluminum alloy. Anything different shall be submitted to PETROBRAS approval. In case of approval, this alloy shall not contain in its composition more than 0.25 % of copper and shall comply with the ASTM-B-179 standard (ANSI alloy 356.1).
- 4.21 The equipment and accessories shall attend the classifications zone and groups established by IEC / ABNT.

	TECHNICAL SPECIFICATION	Nº: I-ET-3010.00-5570-767-PPT-001	REV. C
	AREA: -	SHEET: 8 of 38	
	TITLE:	HULL PUBLIC ADDRESS SYSTEM	
			INTERNAL
			OI/CS

- 4.22 The equipment and materials shall be supplied packed suitable for long periods of storage and be protected against mechanical impact and adverse weather conditions.
- 4.23 Equipment and materials shall be supplied and installed with all threads, hinges, bolts, cover plugs, cable glands and flanges lubricated with anti-seize (loctite) or similar grease.
- 4.24 Equipment and materials shall be supplied with cable passage holes sealed with plastic plugs in the holes to be used and definitive plugs (made of the same material as the equipment and accessories) in the reserve holes.
- 4.25 Brackets, bolts, nuts, washers and any other mechanical fixing elements shall be made in stainless steel.
- 4.26 In outdoor areas, exposed to marine atmosphere, CONTRACTOR shall avoid the galvanic corrosion of junction boxes supports, horns supports and bolts. Galvanic insulation shall be implemented wherever contact between different metallic materials is needed.
- 4.27 Preferably, horn support in outdoor area shall be made of the same material of the horn itself.
- 4.28 The designer shall make arrangements for avoid acoustic feedback from sound boxes through microphones/transmitter cartridges, that can produce whistle and others undesirable noises in system.
- 4.29 The Public Address System designer shall guarantee to avoid of acoustic feedback which generates undesirable noises (whistle by acoustic coupling between microphone and sound transducers).
- 4.30 Electrical equipment installed in external (open) safe areas, foreseen to operating during emergency shutdown ESD-3 shall be certified for installation in hazardous areas Zone 2 Group IIA temperature T3, according to IEC 61892-1.
- 4.31 Detailed design shall be render feasible through strategic installation of components, so as to minimize the number of connections and thus optimize costs of materials and/or work to be done.
- 4.32 Detailed design of PAGA System shall be performed in such a manner as to permit the maximum number of facilities (equipment, cables, accessories) to be installed during construction of PETROBRAS FPSO Unit at Job Site (on shore).
- 4.33 Equipment shall have casing grounded. Grounding by simply supporting the casing on the steel structure of the FPSO shall not be deemed adequate.
- 4.34 Equipment, cables, boxes, materials and accessories for installation in the industrial areas (outdoor or indoor) of unit shall be specified and assembled taking into account the adverse operating conditions on FPSO such as:

TECHNICAL SPECIFICATION		Nº: I-ET-3010.00-5570-767-PPT-001	REV. C
AREA:	-		SHEET: 9 of 38
TITLE:	HULL PUBLIC ADDRESS SYSTEM		INTERNAL
			OI/CS

- a. Atmosphere with high content of humidity, salts hydrocarbons and other corrosive factors;
 - b. Environment subject to the presence of explosive gases shall be in accordance to Hazardous area classification;
 - c. Exposure to weather conditions (sun and rain) and maritime atmosphere;
 - d. Air temperature: From -10°C up to +50°C;
 - e. Air Humidity: 95%
- 4.35 A free space of at least 01 (one) meter wide shall be left between the front of the connection boxes and any other structure or piece of equipment, in order to facilitate servicing.
- 4.36 Equipment and accessories shall be specified, built and assembled using non-combustible, non-corrosive and mechanically rigid materials.
- 4.37 The equipment and Intercommunication Distribution Boxes (CDI) for industrial areas shall be built in such a manner that, after installation, the rear face is spaced away from the wall support.
- 4.38 All equipment of the PAGA System, located external and in industrial areas, shall be installed under conditions whereby there is always a floor below them so as to provide protection and easy access for servicing.
- 4.39 It shall be taken as parameter for the installation of the sound transducer a height between 2.20 and 2.50 meters from its level/deck floor to facilitate maintenance.
- 4.40 Launch down of cables shall constitute the following criteria:
- a. Horizontal runs, at intervals of less than 2 (two) meters;
 - b. Vertical runs, at intervals of less than 1 (one) meter;
 - c. Curves, at the ends only (beginnings and end) for the cables.
- 4.41 The CDI shall be installed in such a way that its geometrical center is 1.30 meters above floor level, and in places where there is free access, never in locations where might be closed at any time. It shall also be positioned so that doors open preferably towards the left side and, in no case, upwards.
- 4.42 When designing a CDI, its size and shape should be chosen taking into account the devices it will house and what else may be added in future (20% spare), in order to enable easy servicing even after future expansion.
- 4.43 Interconnection Boxes shall not be installed in areas where they would be exposed to the weather. If, in fact, that installation is necessary, boxes suitable for the purpose and built with necessary Ingress Protection degree shall be used.

TECHNICAL SPECIFICATION	Nº: I-ET-3010.00-5570-767-PPT-001	REV. C
AREA: -	SHEET: 10 of 38	
TITLE: HULL PUBLIC ADDRESS SYSTEM		INTERNAL
		OI/CS

- 4.44 In order to avoid humidity and water ingress inside the junction boxes, CONTRACTOR shall apply appropriate material in the screw thread, bolts, cable glands, cover plugs and joints, according to IEC 60079 and IEC 60529.
- 4.45 When drilling holes in boxes for incoming and outgoing cables by means of cable glands, care shall be taken to refrain from drilling more holes than it is necessary and, if in fact this may occur, the extra holes shall be closed with plugs.
- 4.46 The PAGA distribution boxes (CDI) shall have the cable glands installed facing lateral sides and/or bottom side. Cable glands installed facing upward are not acceptable. It is also not acceptable any opening facing the upward of the box, even if it is closed by cover plug.
- 4.47 The PAGA Horns shall have the cable glands installed facing the bottom side. Cable glands installed facing upward are not acceptable. It is also not acceptable any opening facing the upward of the horn, even if it is closed by cover plug.
- 4.48 All grounding bus bars shall be of tin-plated copper and painted with green strips.
- 4.49 Connections to the grounding network for equipment and boxes shall be made by means of bolted terminals.
- 4.50 The terminals block installed in General Intercommunications Distributor (DGIs), shall be knife type, as required and as illustrated below, only for reference.

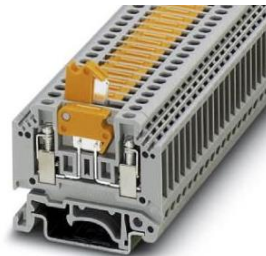

Figure 1: Knife Type Connection Terminal Block with Socket screws

- 4.51 The terminals block installed in Distribution Boxes (CDI), shall be SAK type, proper to junction boxes they are expected to be installed in, as required and as illustrated in Figure 2A, only for reference. In these terminal blocks the conductors shall be separated by separation plate as shown in Figure 2B as reference.



Figure 2A: Screw Connection Terminal Block



Figure 2B: SAK type separation plate

	TECHNICAL SPECIFICATION	Nº: I-ET-3010.00-5570-767-PPT-001	REV. C
	AREA: -	SHEET: 11 of 38	
	TITLE:	HULL PUBLIC ADDRESS SYSTEM	
		INTERNAL	OI/CS

- 4.52 CONTRACTOR shall derivate the cables connections only inside of any peripheral device such as Page-Party Station (ACCESS UNIT), Acoustic Horns (COR), Ceiling Loudspeakers (AFT), Acoustic Boxes (CAC) and others.
- 4.53 The audio line cables derivation also could be done inside of the Junction Boxes (CJ) and Intercommunication Distribution Boxes (CDI), as required or approved by PETROBRAS.
- 4.54 At the Acoustic Horns in external area all cable glands shall be installed in the bottom direction. Cable glands installed facing upward side are not acceptable.
- 4.55 Acoustic booths shall be installed with the front side acoustically protected against the main source of noise (which accounts for the greater portion of the ambient noise).
- 4.56 ACCESS UNIT installed in harsh environments shall be suitable for the respective environmental conditions.
- 4.57 The LSE's shall be identified with a visible plate (in Brazilian Portuguese) as an LSE of PAGA system.
- 4.58 Wall type ACCESS UNIT shall be installed with their center of gravity placed 1.50 m above the floor.
- 4.59 All ACCESS UNIT and Access Control Unit shall be connected to both PAGA Systems.
- 4.60 In each diving areas shall be foreseen the installation of an Intercommunication Distribution Box (CDI) for each PAGA System (A and B) in order to prepare to connect the PAGA systems to Diving Containers.
- 4.61 CONTRACTOR shall ensure by inspection of a qualified personnel that all equipment installations are according to the IEC/ABNT standards requested in this technical specification.
- 4.62 CONTRACTOR shall provide the CITs (CIT-A and CIT-B) which shall exclusively allow frontal access for assembly and subsequent maintenance.
- 4.63 Elevator shall be attended by PAGA System.
- 4.64 A cooling system shall be installed for each cabinet and it shall be composed by 02 (two) fans on the bottom to inflate cold air inside and 02 (two) fans on the top to exhaust heated air to be collected by exhausters on ceiling. Additional clarifications for HVAC at I-MD-3010.00-5510-760-PPT-001 GENERAL CRITERIA FOR TELECOMMUNICATIONS DESIGN.

TECHNICAL SPECIFICATION	Nº: I-ET-3010.00-5570-767-PPT-001	REV. C
AREA: -	SHEET: 12 of 38	
TITLE: HULL PUBLIC ADDRESS SYSTEM		INTERNAL
		OI/CS

5. SYSTEM DEFINITIONS

5.1 PUBLIC ADDRESS SYSTEM

This system comprises the equipment, supplies and accessories duly arranged for the acoustic distribution of communications. The unit may be broken down into the following functional components:

5.1.1. Communication Service Lines (Audio Lines)

This service comprises the audio inputs, consisting of peripheral and central equipment, cables and electronic modules for generating, equalizing levels and frequencies, control, monitoring, control of auxiliary functions and layout of the priority services pertaining to the PAGA System.

5.1.2. Amplification Group or Channels

This means the intermediate circuits consisting of audio amplifying modules that boost the electric power for the priority signals of the service lines feeding the sound processing distribution network. These modules shall be grouped in line with the layout of the "service lines" and the configuration of the sub-networks for the required sound transducers, as follows:

5.1.2.1. Group "A/C"

Supplying the "A/C" sound transducers sub-networks described below.

5.1.2.2. Group "C"

Supplying the "C" sound transducer sub-networks described below.

5.1.3. Sound Transducers Distribution Network

- a. The sound transducer network shall be arranged as ring/loop wired configurations for prevent a failure for a single cable break because this will not inhibit operation to all loudspeakers.
- b. The audio output circuits (audio Lines) consisting of central and peripheral equipment (sound processing units and accessories), for selective acoustic distribution of communications.
- c. The PAGA System shall be capable of supporting the operation of 02 (two) different sub-networks of sound transducers, operating as sound transducers distribution networks at 100 Volts lines.
- d. The schedule defining the areas covered by Alarm/Operational Calls will be delivered to CONTRACTOR during detailed engineering phase.
- e. For the optimization of cable trays and routes it can be done the loop in-out of the cable in the same cable tray of the same system for inner areas: cable tray dedicated for PAGA-A and cable tray dedicated for PAGA-B. For outer areas

of Main Deck and Forecastle, the return loop cable shall be run to different routes as far as possible to each other.

- f. The audio loop return lines shall be designed so that no long paths without any transducer or junction box installed is provided. It shall be taken into account the feasibility of installation and maintenance of long paths to better define how long this path can be. Such detail design shall be submitted to PETROBRAS approval.

5.1.4. Network "A/C"

The sound transducers are normally squelched and the signals shall be reproduced at sound transducers in accordance to priority levels from "01" to "05" and the level "01" is the high priority:

- a. Priority 01: Priority Messages (C);
- b. Priority 02: Alarms (C);
- c. Priority 03: Announcements (A);
- d. Priority 04: Operational Calls (A);
- e. Priority 05: Tests Tones Alarms.

5.1.5. Network "C"

The sound transducers are normally squelched and the signals shall be reproduced at sound transducers in accordance to priority levels from "01" to "03" and the level "01" is the high priority:

- a. Priority 01: Priority Messages (C);
- b. Priority 02: Alarms (C);
- c. Priority 03: Tests Tones Alarms.

- 5.1.6. Both PAGA Systems (A and B) shall be shared in, at least, three (03) zones, in order to make it possible to adjust the volume in the different zones. As example: Sleeping Areas (C), Internal Areas (A/C) and External Areas (A/C).

- 5.1.7. The following figure is a schematic drawing of the PAGA System.

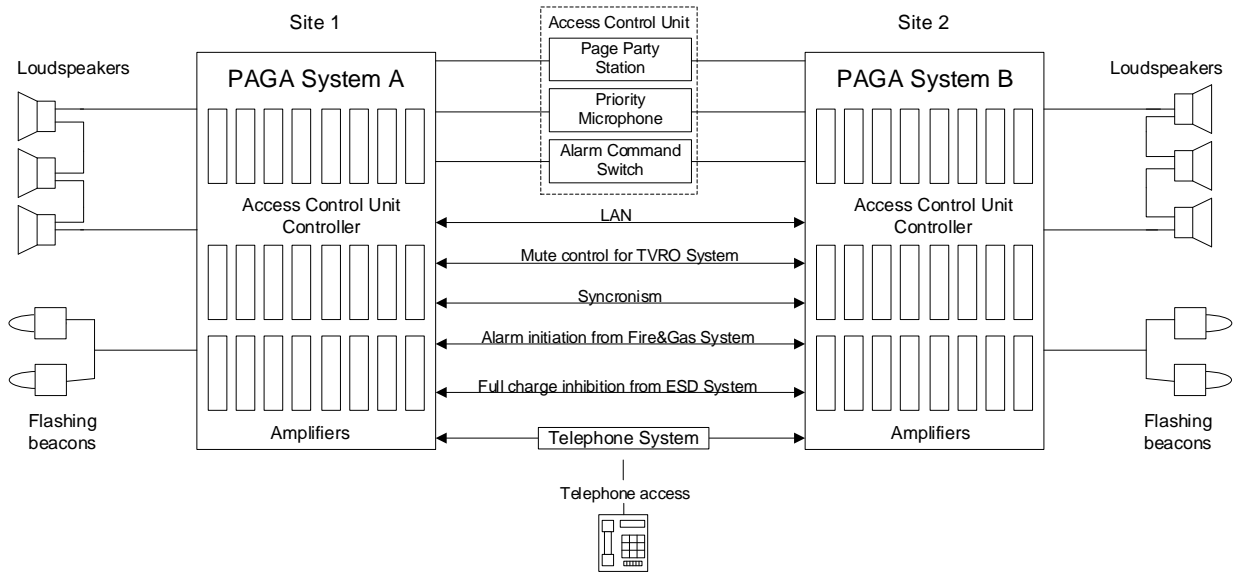

Figure 3: PAGA System topology

5.1.8. PAGA Central Station (CIT)

5.1.8.1. The CIT is the central station that controls all the functions of the PAGA system. In this cabinet are installed the controller, amplifiers, amplifier monitor, alarm tone generator and other necessary modules.

5.1.9. Access Unit (AU)

- a. Peripheral equipment located at strategic places, featuring selective button to provide public announcements.
- b. ACCESS UNIT shall be provided strategically located at muster points, close to lifeboats, offloading areas, emergency and auxiliary generator rooms.
- c. The Access Unit is commonly called page-party station, but with no conversation features among them.

5.1.10. Access Control Unit (ACU)

5.1.10.1. Peripheral equipment located at Central Control Room (CCR), GEPLAT Office and Radio Room that joins 03 (three) functions as one:

- a. Alarm Command Switch (CA) composed of 03 (three) buttons: one to activate Emergency alarm tone, one to activate Prepare to Abandon Platform Alarm (PAPA) tone; one to deactivate both alarm tones;
- b. Priority Microphone (MIC) composed by 01 (one) button that enables to make priority announcements over alarms;
- c. Public announcements composed by 01 (one) button that enables to make regular non-priority announcements.

TECHNICAL SPECIFICATION	Nº: I-ET-3010.00-5570-767-PPT-001	REV. C
AREA: -	SHEET: 15 of 38	
TITLE: HULL PUBLIC ADDRESS SYSTEM		INTERNAL
		OI/CS

- 5.1.10.2. PAPA alarm shall only be activated manually from Access Control Unit bottom, once it is due to a PETROBRAS representative final deliberation. So, it cannot have interface to any Automation System.
- 5.1.10.3. Alarms will only be canceled by alarm command switch located in the access control units.
- 5.1.10.4. Access Control Unit shall be provided strategically located at Radio Room, CCR and GEPLAT Office.
- 5.1.10.5. Access Control Unit shall also be provided inside the PAGA cabinets (CIT).
- 5.1.11. Sound Transducers
- a. Peripheral equipment that permits release of power sound messages around the FPSO Unit, from amplifiers and that may consist of an Acoustic Boxes, Ceiling Loudspeakers or Acoustic Horns.
 - b. The sound transducers shall be supplied with a “line transformer” installed internally, coupling them with the distribution line, with taps for audio power adjustment to be done only by the maintenance personnel.
 - c. Sound transducers Input line: 100V
 - d. By changing taps of “line transformer” shall be possible to do the power adjustment and obtain the suitable hearing of audio messages in ambient.
- 5.1.12. General Intercommunication Distributor (DGI)
- 5.1.12.1. This is the main distribution box of the system. It connects PAGA central Station with the Intercommunication distribution boxes (CDI). Its function is to distribute all the PAGA’s network to internal and external areas.
- 5.1.13. Intercommunication Distribution Box (CDI)
- 5.1.13.1. This is the intermediate distributor box or panel, used for the distribution of the interconnections of the General Intercommunication Distributor (DGI) with the Access Unit, and the sound transducers networks.
- 5.1.14. Electrical Junction Box (CJE)
- 5.1.14.1. This is the intermediate distributor box or panel, used for the distribution of the interconnections of the PAGA Central Station (CIT) with the Emergency Signaling Lamp (LSE) networks.
- 5.1.15. Terminal blocks
- 5.1.15.1. Blocks for connecting electrical conductors of Access Unit and sound transducers networks and sub-networks installed in General Intercommunication Distributor and Intercommunication Distributor Box.

	TECHNICAL SPECIFICATION	Nº: I-ET-3010.00-5570-767-PPT-001	REV. C
	AREA:	SHEET: 16 of 38	
	TITLE:	HULL PUBLIC ADDRESS SYSTEM	
		INTERNAL	OI/CS

5.1.15.2. The terminal blocks shall be arranged so as to facilitate differentiation between the circuits of the respective networks.

5.1.16. Cable Glands

5.1.16.1. Devices used for mechanical attachment of the electric cables to the distribution boxes or panels providing for the use of such units.

5.1.17. Cover Plugs

5.1.17.1. Devices used for mechanical cover of the not used or spare openings in the distribution boxes or panels.

5.1.18. Emergency Signaling Lamp

5.1.18.1. Lamps used together or not with the sound transducers in areas where are high surrounding noise level. Lamps indicate, "Emergency" or "Prepare to Abandon" warnings of danger shall be in green color and flashing or strobe type.

5.1.19. Multi Cable Transit

5.1.19.1. The characteristics of these devices shall be in accordance with areas where they will be installed. The supplier shall present Certificates of Conformity to attend requirements, such as:

- a. Protection against fire, smoke, gas, water, vibration or noise;
- b. To be models suitable for installation in Hazardous Areas (potentially explosive areas).

5.1.20. INTERCONNECTIONS NETWORK – Hull & Topsides Modules

5.1.20.1. Intercommunication Distribution Boxes for each system ("A" and "B") shall be installed by HULL provider in different places at the external area of UNIT for interface with the Main Deck, Topside and each Modules of PAGA networks of systems "A" and "B".

5.1.20.2. The interconnection of Hull Intercommunication Distribution Boxes with Modules, packages and cranes Intercommunication Distribution Boxes shall be done by CONTRACTOR. So, it will be gotten the Intercommunication and the Sound Coverage, with system "A" and system "B", all over the whole Unit (Hull and all Topside Modules).

6. TECHNICAL REQUIREMENTS

6.1 Each PAGA System (System A and System B) shall have an exclusive Secondary Power Source, installed in different places, as far as possible from each other. The

battery bank used for each secondary power source shall be installed in appropriate area defined during the detailed design.

6.2 The PAGA System shall have two proper and independent electrical power supplies:

- a. Primary power source (AC): 220 VAC (+ 15%) from essential energy system;
- b. Secondary power source (DC): 48 VDC or 24 VDC (+ 15%) (Exclusive for each system PAGA)

6.3 If the secondary power is AC too, a reliable AD/DC converter shall be proposed and submitted to PETROBRAS approval.

6.4 PAGA Remote Access

6.4.1. CONTRACTOR shall supply all devices necessities to provide the remote access to PAGA system A and PAGA system B, of the facilities below:

- a. Announcements calls;
- b. Priority calls;
- c. Alarms initiation;
- d. And at least 02 (two) remote loudspeakers to monitoring the system.

6.4.2. The remote access solution shall be based on IP Protocol, in order to use the PETROBRAS WAN network

6.4.3. All remote devices shall be CONTRACTOR scope to be installed in the PETROBRAS Remote Control Room.

6.4.4. The PETROBRAS Remote Control Room location will be informed during the detailed design.

6.4.5. CONTRACTOR can consider supplying a small PAGA unit to provide announcements calls; priority calls; alarms initiation and at least 02 (two) remote loudspeakers to be installed in the Remote Control Room located in PETROBRAS onshore installation.

6.5 MANAGEMENT FEATURES

6.5.1. The PAGA system A and PAGA system B shall have a management tool based in IP protocol to be connected to corporative LAN.

6.5.2. Protocol properties

- a. SNMPv2;
- b. TCP/UDP over IPv4 or IPv6;
- c. Sending and receiving SNMP requests

- d. Sending SNMP traps
- e. MIB is based on SNMPv2
- f. E-mail interface for forwarding of fault messages

6.5.3. Interface

- a. RJ45 Ethernet interface onboard

6.5.4. The management tool shall be able to configuration and monitoring the system and modify the settings such as:

- a. Volume settings
- b. Zone definitions
- c. Calls priorities
- d. Interface to external systems

6.6 CONTRACTOR shall assure that all sound transducers supports for fixing, shall have azimuthal adjustable facilities, as illustrated below:

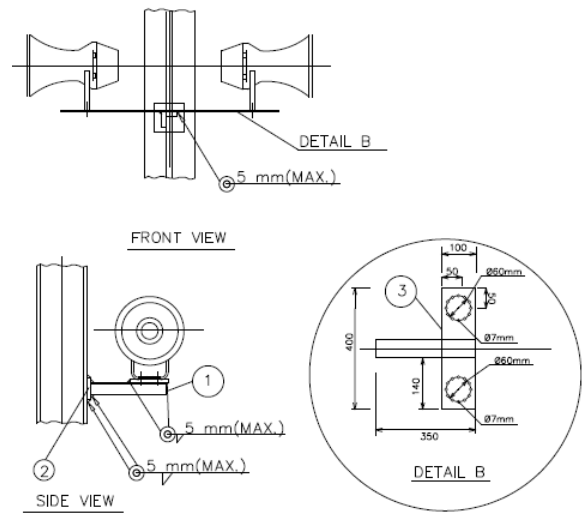

Figure 4: Horn support examples

6.7 Sleeping Area Requirements

6.7.1. Where audible appliances are installed to provide signals for sleeping areas, they shall have a sound level of, at least, 15 dB above the average ambient sound level or 5 dB above the maximum sound level having a duration of, at least, 60 seconds or a sound level of, at least, 75 dBA, whichever is greater, measured at the pillow level in the area required to be served by the system using the A-weighted scale (dBA).

6.7.2. If any barrier, such as a door, curtain, or retractable partition, is located between the notification appliance and the pillow, the sound pressure level shall be measured with the barrier placed between the appliance and the pillow.

6.8 Visual Signaling

6.8.1. Audible signals in high noise areas shall supplement with visual signals.

6.8.2. The Emergency Signaling Lamps (LSE) shall be used together with the loudspeakers in areas where the surrounding noise level exceeds 90 dB(A).

6.8.3. The LSE shall indicate "Emergency" or "Prepare to Abandon" warning of danger will be green color, strobe or flashlight type.

6.8.4. CONTRACTOR shall identify the rooms and spaces that will have audible notification and those where audible notification will be complemented by LSE.

6.8.5. Both PAGA Systems (A and B) shall be divided in, at least, three (03) zones, in order to make it possible to adjust the volume in the different zones. The minimum zones shall be: Sleeping Areas (C), Internal Areas (A/C) and External Areas (A/C).

a. Zone 1: Sleeping Areas (cabins), with C (Call emergency) line.

b. Zone 2: Internal Areas (all internal areas in Accommodation Module without Zone 1 areas, with A/C (Announcement/Call emergency) line.

c. Zone 3: Engine Room, external areas from Accommodation Module and all other external areas in Topsides, with A/C (Announcement/Call emergency) line.

6.8.5.1. CONTRACTOR may propose more zones during the detailed design.

6.8.5.2. Just in case such volume adjustment can be done directly from amplifier, it will be acceptable one 02 (two) zones: sleeping areas (C line) and non-sleeping areas (A/C line)

6.9 CABLES AND OTHER EQUIPMENT REQUIREMENTS

6.9.1. To ensure proper operation of the PAGA System, care shall be taken to maintain public address cables far from energy cables to prevent against electrical noise or others undesirable interference. Crossings, if any, shall be arranged at right angles.

6.9.2. For cables incoming and outgoing the PAGA Systems equipment rack, shall be sealed with cable passive fire stop systems (physical barrier) to prevent the spread of flames out of the rack in case there is fire inside it.

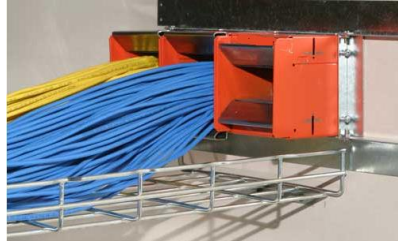
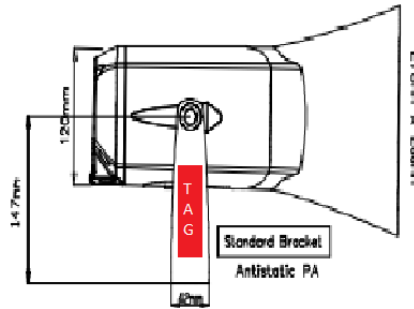

Figure 5: Physical Barrier example

- 6.9.3. For cables crossing between external and internal area, which would make use of MCT or holes, those shall be sealed with rubber stoppers so as prevent the passage of gases between different compartments.
- 6.9.4. All cables shall be suitable for installation in cable trays, conduits or ducting and subject to exposed to rainfall liquid hydrocarbon splashing, maritime atmosphere and exposition to sunshine (UV Resistant).
- 6.9.5. Cables shall have no curves in their routing tighter than the limit values specified by the manufacturers.
- 6.9.6. Cables shall have no splices at any point of their run.
- 6.9.7. Armored cables shall be used only in areas, in which there is considerable probability of accident by mechanical attack and their armor shall be properly grounded.
- 6.9.8. Cables and conductors shall be identified in both ends by means of tags, made with suitable material for each place.
- 6.9.9. Cables shall be terminated in cable glands classified in accordance with the equipment they will be attached to. When equipment is not suited to the use of cable clamps, the cables shall have their ends terminated with sweated-on sleeves or self-melting tape.
- 6.9.10. Cables shall have its outer sheaths in orange color.
- 6.9.11. All incoming and outgoing cables in the boxes shall be installed using cable glands, for all cases, only through the lower or laterally sides. It will be not accepted cable glands or cover plugs facing to the upside of the boxes.
- 6.9.12. At the Acoustics Horns all cable glands shall be installed facing to the bottom direction. Cable glands installed facing to top side will be not acceptable.
- 6.9.13. The interface boxes shall be tagged with a stainless-steel plate fixed in its front door by bolt or other suitable material to fix it.
- 6.9.14. The acoustic horns shall be tagged with a stainless-steel plane fixed in its supports with bolts or other suitable material to fix it. As the example in Figure 6.

 Figure 6: Example of **acoustic** Horn Tagging

- 6.9.15. The other devices of the PAGA System shall be tagged in its bodies or in structures close to these devices by bolts or other suitable material to fix it. In case of the tag fixed in structure close to the device the distance between both shall not exceed 20 mm.
- 6.9.16. The cableway of the System A and of the System B shall run for two different routes, as far as possible, avoiding them crossing.
- 6.9.17. Cable shall be flexible type (Class 2) complying with the applicable existing standards.
- 6.9.18. For PAGA cables it will accept the use of Class 2 Cable, obeying the same criteria used by the Electrical and Automation disciplines listed in item 5.13.3 (Constructive training) of I-ET-3010.00-5140-700-P4X-002 (SPECIFICATION FOR ELECTRICAL MATERIAL AND EQUIPMENT FOR OFFSHORE UNITS).
- 6.9.19. Insulation
- a. The cables shall contain insulation in ethyl-propylene rubber (EPR) or Crosslinked Polyethylene (XLPE) for use in industrial areas and halogen-free rubber / Low Smoke Zero Halogen (LSZH) for internal and industrial cables installed in panels and lodging areas, with good thermal characteristics, ozone and corona effects resistant, in addition to withstanding the following temperature conditions:
 - i. A maximum of 85°C in continuous operations (damp or dry places);
 - ii. 130°C under emergency over-load conditions;
 - iii. 200°C under short-circuit conditions;
 - iv. All cables shall be below voltage types (250 volts), unless the cables destined to feed LSE, that shall be manufactured to operate with voltages higher than 250 V;
 - v. Twisting Pairs: each pair of cables shall be twisted with an adequate pitch winding.
 - b. Outer sheath insulation (protective cover) type shall be SHF1 or SHF2 according to IEC 60092-360 and IEC 61892-4.
- 6.9.20. Network Cabling

The cables used on equipment interconnection shall attend the criteria bellow:

- a. Minimum cross section cables: 1.00 mm²
- b. Voltage drop in “audio circuits” (at AC): < 10 %
- c. Voltage drop in “DC” circuits: < 5 %

6.9.21. Other requirements in according with Classification Society

- a. Cables for circuits that shall operate under fire conditions, such as those installed in topsides Process areas, and cables crossing machinery space category A, as defined by SOLAS, shall be certified for circuit integrity under fire conditions, according to IEC 60331. CONTRACTOR shall attend this requirement without additional costs to PETROBRAS. The Classification Society shall supply a list with the places or one document of rules to be followed by the CONTRACTOR, where will show these requirements.
- b. CONTRACTOR shall submit the detailed design with the cables list for approval by the PETROBRAS and Classification Society.

6.10 TECHNICAL CHARACTERISTICS

6.10.1. Characteristic Classification of Areas and Environmental Conditions

HAZARDOUS AREAS (Potentially explosive areas) Zones and groups attending the standards defined by IEC and ABNT	Areas exposed to weather and/or harsh environments	ACCESS UNIT	Certified (In protection box)
		CDI, LSE, COR Cable Gland, cover plug.	Certified (Minimum Protection Level: IP-66)
	Areas not exposed to weather and/or harsh environments	ACCESS UNIT, CDI, LSE, COR, Cable Gland, cover plug	Certified (Minimum Protection Level: IP-55)
NON-HAZARDOUS AREAS	Areas exposed to weather and/or harsh environments	ACCESS UNIT	Certified (In protection box)
		CDI, LSE, COR, Cable Gland, cover plug	Certified (Minimum Protection Level: IP-66)
	Areas not exposed to weather and/or harsh environments	ACU, ACCESS UNIT, CDI, LSE, COR, AFT, CAC, Cable Gland, cover plug	Uncertified (Minimum Protection Level: IP-44)

6.10.2. Sound Transducer Characteristics

6.10.2.1. Acoustic

- i. Acoustic Horns (COR):
 - Sensitivity to 1 kHz / 1 watt / 1 meter > 105 dBA

- Angle of spreading (horizontal & vertical) > 60 degrees
- Suitably rugged and with its external bodies made in non-metallic materials

ii. Acoustic Boxes (CAC) and Ceiling Loudspeakers (AFT):

- Sensitivity to 1 kHz / 1 watt / 1 meter ≥ 85 dBA
- Angle of spreading (horizontal & vertical) > 60 degrees

6.10.2.2. Frequency Responses

- Acoustic Horns (COR) Better than 300 to 7,000 Hz; +/- 20 dB
- Acoustic Boxes (CAC) Better than 400 to 8,000 Hz; +/- 10 dB
- Ceiling Loudspeakers (AFT) Better than 400 to 8,000 Hz; +/- 10 dB
- Other equipment > 200 to 10,000 Hz; +/- 3 dB

6.10.2.3. Electrical Impedance

- Input Transformer 70/100 volts audio lines
- Output Transformer 8 / 20 ohms

6.10.2.4. Audio Amplifier (AMP)

- Input Voltage (AC) 220 VAC (+ 15%)
- Input Voltage (DC) + 48 VDC or + 24 VDC (+ 15%)
- Audio power output From 350 up to 500 watts (RMS)
- Output impedance 70 / 100 volt line
- Maximum distortion 10 % (ten percent)
- Frequency response From 300 up to 10,000 Hz, within + 3 dB
- Signal-noise ratio Better than 70 dB
- Adjustment control Gain, bass and treble, with restricted external access
- Protection and Warning Output short-circuit and open circuit
- Power meter "Bar-graph" type on front panel, displaying in watts RMS

6.10.2.5. Amplifier Monitor (MA)

- a. Central equipment, which executes manual and automatic monitoring and transfers to a stand-by amplifier unit which is out of operation or in servicing.
- b. As reference, for each group of 05 (five) amplifiers there shall be 1 (one) stand-by unit, comprising a total set of 06 (six) monitored amplifiers.
- c. Capacity shall be available for monitoring up to 06 (six) amplifiers at the same time, including the stand-by unit, producing the respective visual and individual signals to indicate "normal" and "abnormal" operating states. When monitoring is done, any amplifier which is found in an "abnormal" operating state shall have its input and output manually or automatically transferred to the stand-by amplifier, if the stand-by amplifier is under normal operating conditions.

6.10.2.6. Access Control Unit and Access Unit features

- Power Supply 24 VDC from power supply (FAI)
- Maximum harmonic distortion 10%
- Frequency response 300 to 5,000 Hz, within + 3 dB
- Operating temperature From -10 °C to +50 °C
- Maximum relative air humidity 95%
- Cabinet with "PTT" button for public announcements
- Handset with spiral cable or Microphone couplet
- The transmitter microphone cartridge shall be a noise canceling type

6.10.3. Alarms Tones Generator (CTA)

6.10.3.1. The CTA unit must produce the following warning tones:

- a. Emergency: regular 1,000 Hz square wave lasting approximately 1 second, transmitted at equal intervals of approximately 1 second.
- b. Prepare to Abandon: regular 1000 Hz square wave of continuous duration.

6.10.3.2. It shall be furnished 02 (two) CTA for redundant operation (inside each PAGA cabinet), interconnected with all 03 (three) CA, with CONTROL SAFETY SYSTEM (CSS) (Automation System for remote command), with CCR Emergency Panel (Automation System) and with Radio Room Emergency Panel (Automation System) to activate alarm signals or cancel them; Electrical feeding: 24 VDC from Power Supply (FAI).

6.10.3.3. In order to enable the confirmation of a good operation of CTA, each of them shall have a local test switch with a small loudspeaker; by actuation the test switch, it will be possible to listen the alarm tones only at small loudspeaker

from CTA, with no broadcasting to the entire acoustic horns and loudspeakers network of Public Address System.

6.10.4. Interconnection between PAGA System and CSS System

- a. Automation CSS System shall be able to automatically start a real Emergency Alarm (intermittent sound) due to a Fire&Gas confirmation. This shall be implemented through a hardwired signal from CSS System to each PAGA System cabinet.
- b. In order to avoid spurious alarm triggering, it shall be foreseen, from CSS to PAGA cabinets, monitored digital outputs signals, therefore in case of cable failure or cable connector failure, the unreal emergency Alarm would not be triggered in PAGA System. By such monitoring, it would be possible to identify, through a priority alarm in SOS HMI, this interconnection failure to fix it immediately.
- c. However, just in case the PAGA System and the CSS System cannot develop a proper monitoring for such interconnection cable, a safety failure condition shall be implemented for such cable that triggers Emergency Alarm in case of cable/connector/interconnection signal failure. It shall be done through a hardwired signal from CSS System to each PAGA System cabinet by means of a normally closed (NC) contact with continuous signal, so that, in a real event of signal absence from CSS to PAGA, PAGA Emergency Alarm will automatically be activated. Such NC contact (safety failure) protects PAGA System against any cable or connector problems: if interconnection cable or connectors accidentally fails, Emergency Alarm can be automatically triggered too, even if it is an unreal situation not confirmed by Fire&Gas System, otherwise cable failure would not be noted and real alarm from Fire&Gas System would not trigger a real alarm.

6.10.5. Access Units Protection Box

It shall be used a protection box, according to classification area and water ingress, to shelter ACCESS UNIT sets, support structure and assembly plate for ACCESS UNIT.

6.10.6. Emergency Signaling Lamps (LSE)

- | | |
|---------------------------|--------------------------------|
| • Operational temperature | -55°C to +65°C |
| • Material | corrosion-free GRP |
| • Lens colour | green |
| • Mounting | wall mounted via bracket |
| • Light power | 10 Joules |
| • Operating modes | flashing light or strobe light |
| • Flash rate (max.) | 1Hz |

7. SCOPE OF SUPPLY

The scope of supply shall be composed of all features mentioned in the following items:

7.1 PUBLIC ADDRESS CENTRAL STATION (CIT)

- a. Quantity: 02 (two) PAGA Systems (System A and System B).
 - i. System A (CIT-A) – CIT installed in the Telecom Upper Room at Accommodation Module;
 - ii. System B (CIT-B) – CIT installed in the Telecom Lower Room at Accommodation Module.
- b. All units such as Audio Amplifiers (AMP), Alarms Tones Generator (CTA), with operation and installation centralized shall be installed in ergonomically suitable cabinets in each Telecom Room.
- c. The total acoustic power of each PAGA system shall be able to feed all loudspeakers of this system in all FPSO, including accommodation, engine room, main deck, all topside modules and forecastle area.
- d. The acoustic power shall be result of a calculation report to define the number of loudspeakers.
- e. It shall be provided an interface between CIT-A/CIT-B and CSS-HFGS according to I-ET-3010.00-5520-861-P4X-001 - CONTROL AND SAFETY SYSTEM - CSS."

7.2 MAIN DISTRIBUTION BOARD (MDF)

- a. This board connects the Public Address Stations with the sound transducers network, flash beacons and Access Units.
- b. It shall be provided 01 (one) independent MDF for each PAGA (System A and System B).

7.3 PRIORITY MICROPHONE (MIC)

- a. Quantity = 05 (five)
- b. This means a portable microphone of the "push to talk" (PTT) type, with support for attachment to structural points to be defined during the project.
- c. Both Systems (System A and System B) will be activated simultaneously by the use of the priority microphones.
- d. Therefore, Priority Microphone (MIC) shall be provided and strategically installed at GEPLAT Office, CCR, Radio Room and 01 (one) unit in each PAGA rack.

	TECHNICAL SPECIFICATION	Nº: I-ET-3010.00-5570-767-PPT-001	REV. C
	AREA: -	SHEET: 27 of 38	
	TITLE:	HULL PUBLIC ADDRESS SYSTEM	
		INTERNAL	OI/CS

7.4 ALARM COMMAND SWITCH (CA)

- a. Quantity = 05 (five)
- b. Box containing 3 (three) electrical push-buttons or switches ("Emergency", "Prepare to Abandon" and "Reset"), protected to prevent accidental operation, to actuate the acoustic alarm signals or cancel them, and that are strategically located on the PETROBRAS FPSO Unit.
- c. The two units, System A and System B racks, will be activated simultaneously by the use of the alarm command switches.
- d. Therefore, Alarm Command Switch (CA) shall be provided and strategically installed at GEPLAT Office, CCR, Radio Room and 01 (one) unit in each PAGA rack.

7.5 ACCESS CONTROL UNIT (ACU)

- a. Access Unit, Priority Microphone and Alarm Command Switch functions can be provided together by means of an Access Control Unit.
- b. Therefore, at least, 05 (five) access control units shall be provided strategically located at CCR, Radio Room, GEPLAT Office and 01 (one) unit in each PAGA rack.
 - i. The Access Control Unit shall be desk mounted in Radio Room, CCR and GEPLAT Office

7.6 ALARMS TONES GENERATOR (CTA)

- a. Quantity = 04 (four)
- b. Electronic device which generates standardized warning tones such as "Emergency" or "Prepare to Abandon", which are mutually exclusive and also can be set off by Alarm Command Switches (CA's).
- c. The operation shall have the following priority:
 - i. MASTER: generator 1 (one) in main (A) audio rack;
 - ii. SLAVE 1: generator 2 (two) in main (A) audio rack;
 - iii. SLAVE 2: generator 1 (one) in redundant (B) audio rack;
 - iv. SLAVE 3: generator 2 (two) in redundant (B) audio rack.

7.7 ACCESS UNIT

- a. Peripheral equipment located at strategic places, featuring button that provides public announcements.
- b. Therefore, ACCESS UNIT shall be provided strategically located at:
 - i. Near of each lifeboat,
 - ii. Offloading areas,
 - iii. Electrical and automation panel rooms,
 - iv. Engine room,
 - v. Generator room (just in case it is required by Classification Society),
 - vi. Forecastle (Temporary Refuge Room),
 - vii. Access to helideck.

7.8 TESTS TONES GENERATOR (GT)

Each PAGA system shall have an electronic device that generates exclusively testing tones and that can be set off by push-button stations or front-mounted switches.

7.9 TELEPHONE INTERFACE

- a. Quantity = 02 (two)
- b. Electronic device to permit access the PAGA System for transmission of messages from Telephone System. These devices shall record the public announcements before of the transmission. The voice message storage shall be minimum 60 seconds.
- c. This interface will allow the transmission of public announcements over the telephone network, by entering a code to access this facility.
- d. This interface shall provide a 2-wire and 4-wire (RX, M and E) analogue telephone to the connection with the Telephone System.
- e. The 02 (two) Systems (System A and System B) shall be activated simultaneously by the use of telephone interface.
- f. Only 01 (one) PABX extension line number with only 01 (one) PAGA code (8677) shall be capable to access all zones.

7.10 AUDIO AMPLIFIER (AMP)

TECHNICAL SPECIFICATION	Nº: I-ET-3010.00-5570-767-PPT-001	REV. C
AREA: -	SHEET: 29 of 38	
TITLE: HULL PUBLIC ADDRESS SYSTEM		INTERNAL
		OI/CS

- a. Central equipment that amplifies the signals from ACCESS UNIT, TEL, MIC, ACU and CTA to be transmitted through sound transducers networks distributed around the FPSO Unit.
- b. Each AMP shall be loaded such that it will operate at no more than 80% of its nominal power. The AMP shall be rated for continuous operation.
- c. The number of audio amplifier in each PAGA system shall be compatible with the maximum sound power defined by SPL Calculation Memory Report issued by CONTRACTOR during the detailed design using the software defined by this technical specification.
- d. CONTRACTOR shall consider the follow rule for each group of 05 (five) amplifiers it shall be installed 01 (one) "hot stand-by" amplifier, which compose each system (System A and System B) and shall be automatically brought into service if any one of the operational amplifiers fails.

7.11 SOUND TRANSDUCERS (AFT, CAC AND COR)

- a. Peripheral equipment that permits release of power sound messages around the FPSO Unit, from AMPs and that may consist of an Acoustic Boxes (CAC), Ceiling Loudspeakers (AFT) or Acoustic Horns (COR).
- b. The final number of each type of loudspeakers shall be defined though a SPL calculation memory report issued by CONTRACTOR during the detailed design using the software described in this technical specification.
- c. The minimum number of loudspeakers to be supplied by CONTRACTOR shall be as defined in basic design one line diagram and arrangement drawings from Hull.

7.12 AMPLIFICATION MONITOR (MA)

- a. Central equipment, which monitors and permits manual and automatic transfer from an AMP that, has failed to a stand-by unit.
- b. The 02 (two) Systems (CIT), System A and System B, shall have, each of one, their proper Amplification Monitor.

7.13 ELECTRICAL POWER SOURCE

- a. Equipment (in the CIT) intended to provide electrical feed at 48 VDC or 24 VDC to some units in the PAGA System, such as ACCESS UNIT. It shall be supplied 02 (two) FAI for operation in hot stand-by.

	TECHNICAL SPECIFICATION	Nº: I-ET-3010.00-5570-767-PPT-001	REV. C
	AREA: -	SHEET: 30 of 38	
	TITLE:	INTERNAL	
	HULL PUBLIC ADDRESS SYSTEM		OI/CS

- b. The 02 (two) Systems (CIT), System A and System B, shall have, each of one, 2 FAI.
- c. Total quantity = 04 (four) FAI

7.14 GENERAL INTERCOMMUNICATIONS DISTRIBUTOR (DGI)

7.14.1. This is the central distributor panel for interconnection of the CITs with the network sound transducers and ACCESS UNIT, also used for the connection with the Telephone System. Each CIT (System A and System B) shall have one independent panel DGI.

7.15 INTERCOMMUNICATION DISTRIBUTION BOX (CDI)

7.15.1. This is the intermediate distributor box or panel, used for the distribution of the interconnections of the DGI with the ACCESS UNIT and the networks sound transducers. The final quantities shall be defined during the detailed design.

7.16 ELECTRICAL JUNCTION BOX (CJE)

7.16.1. This is the intermediate distributor box used for the distribution of the interconnections of the Electrical panels with the Emergency Signaling Lamps (LSE). The final quantities shall be defined during the detailed design.

7.17 TERMINAL BLOCKS

- a. Blocks for connecting electrical conductors of ACCESS UNIT and sound transducers networks and sub-networks installed in DGI and CDI.
- b. The terminal blocks shall be arranged so as to facilitate differentiation between the circuits of the respective networks.
- c. The final quantities shall be defined during the detailed design.

7.18 CABLE GLANDS

- a. Devices used for mechanical attachment of the electric cables to the distribution boxes or panels providing for the use of such units.
- b. The final quantities shall be defined during the detailed design.

7.19 COVER PLUGS

- a. Devices used for plug unused holes in distribution boxes.
- b. The final quantities shall be defined during the detailed design.

7.20 EMERGENCY SIGNALING LAMP (LSE)

7.20.1. Lamps used together or not with the sound transducers in areas where the high surrounding noise level. Lamps indicate, "Emergency" or "Prepare to Abandon" warnings of danger will be green color, strobe or flashlight type. The final quantities shall be defined during the detailed design.

7.21 BATTERY CHARGER AND BATTERY BANK

CONTRACTOR shall issue to PETROBRAS approval a calculation report regarding to battery charges and battery banks capacity to be used.

7.21.1. Battery Charger

- a. It shall be supplied one battery charger for lead-acid batteries, for each PAGA system, with a sufficient capacity to feed all equipment of the system with a spare capacity of 20%.
- b. A power factor of 80% for loudspeakers in the audio line shall be take into account.
- c. The system shall have a control and monitoring unit in the front panel in order to indicate the input voltage, output voltage, current, battery charge level and battery temperature and at least the following alarms: high voltage, low voltage, earth leakage, temperature and battery charge remaining below the minimum.
- d. Rectifiers toggled in high frequency.
- e. Input voltage of two phase: 220 VAC (180 to 275 VAC), with frequency strip 45 to 66Hz.
- f. Nominal output voltage for consumer: (+24) VCC or (+48) VCC.
- g. Power maximum output: dimensioned to 120% of nominal charge.
- h. Output current will be defined during the detailed design.
- i. Units of rectification shall operate with the current equalized.
- j. Modular system with 02 (two) units of rectification (URs) of 25 Amperes each (maximum), in agreement with the need it shall allow future enlargements.

- k. Ventilation for convection forced (ventilated).
- l. The consumer's voltage will owe strip being narrows, with use of Drop Diode Unit (UDQ).
- m. The electrostatic discharge shall be in agreement with the norm IEC-1000-4-2.
- n. EMC shall be in agreement with norm CISPR22 or EN 55022.
- o. Tension outbreak shall be in agreement with norm IEC-1000-4-5.
- p. Voltage Default and Adjustable Range: 53.5 V DC / 43 - 58 V DC.
- q. Static regulation: + / - 0,1%.
- r. Ripple psometric: <2 mV rms.
- s. Power factor: Greater than 0,89 at 50% load or more.
- t. Acoustic noise: <60 dBa.
- u. Automatic shutdown of the batteries bank for minimum tension in discharge.
- v. Universal interface for system of remote supervision.
- w. Operation temperature: 0-50°C / Relative Humidity: 10% to 95%.
- x. The sensors shall accuse among other the following events: interruption of the batteries and fuse, ventilation lack, flotation abnormal, high / low input / output voltage, discharged battery, height temperature.
- y. It shall have shown of voltage and current by display on front of the equipment.
- z. It shall have protection in the CA input with fuses and suppressors and in the CC output with fuse and high temperature all housed inside appropriate boxes.
- aa. It shall be provided an interface between PAGA Battery Chargers and CSS-HFGS shall be according to I-ET-3010.00-5520-861-P4X-001 - CONTROL AND SAFETY SYSTEM - CSS."

7.21.2. Battery Bank

It shall be supplied a lead-acid batteries bank with a sufficient capacity to feed all equipment of each PAGA system as described below, with a spare capacity of 20%:

- a. Voltage shall be of 24 or 48 Volts.

TECHNICAL SPECIFICATION	Nº: I-ET-3010.00-5570-767-PPT-001	REV. C
AREA: -	SHEET: 33 of 38	
TITLE: HULL PUBLIC ADDRESS SYSTEM		INTERNAL
		OI/CS

- b. Nominal capacity: It shall be defined during the detailed design.
- c. Autonomy: According to IMO-SOLAS, MODU Code and Classification Society rules.
- d. It shall be considered an aging rate of 25% for batteries cells.
- e. As the batteries will be exposed the saline atmosphere, the poles shall be protected to avoid the corrosion and they shall be identified.
- f. The container shall be made of resistant plastic.
- g. The batteries shall be in accordance with ANATEL, ABNT and IEC standards applicable for telecommunications applications.
- h. The battery bank shall be installed in appropriate area defined during the detailed design and in accordance with IMO, IEC and ABNT standards.

8. DIMENSIONING CRITERIA

- 8.1 CONTRACTOR shall submit the Sounding Calculation Report to analysis and approval by PETROBRAS and Classification Society.
- 8.2 Modeling methodology
 - a. CONTRACTOR shall use the noise computation method, with an Acoustic Engineering software to calculate, to present, to assess and to predict the environmental noise and sound traducers noises results, for example: **EASE** – Enhanced Acoustic Simulator for Engineers, **CadnaA** (Computer Aided Noise Abatement), **CadnaR** or **SoundPLAN** softwares.
 - b. In addition, this software will be based on the general noise propagation theory of point sources including reflection, screening and diffuse effects.
 - c. The Predictive acoustic modeling of the unit shall involve determining the acoustic impact of each significant source and combining these individual impacts to determine the overall sound emissions. The modeling procedure accounts for the sound emission level, frequency spectrum, location, height and radiation directivity of the noise source.
 - d. Calculation of noise over the FPSO Unit shall be conducted according to noise propagation theory taking into account environment industrial plant geometrical design and equipment accommodation. This noise calculation includes the following items:
 - i. Effect of reflecting surfaces;
 - ii. Screening effects;
 - iii. Diffusion effects;
 - iv. Effect of atmospheric attenuation;
 - v. Absorption effects.

- 8.3 The sounding design shall be presented in 05 (five) conceptual parts as defined:
- Sound gradient for noisy environments;
 - Description of sounding calculation for ambient to be sounded/covered;
 - Electrical and mechanical features for the equipment;
 - Sound transducers distribution network;
 - Configuration for Central Sounding System.
- 8.4 CONTRACTOR shall be responsible by the Sounding Calculation Description that shall be elaborated according to specific ISO Standards, taking in consideration, at least, the following criteria:
- Open ambient and closed ambient;
 - Gradients for sound noise levels foreseen in the ambient;
 - Areas of required sound coverage;
 - Minimum intelligibility of 85%;
 - Signal / Noise (S/N) ratio within 10 up to 25 dB;
 - Time of reverberation (RT60) calculated taking in account the dimensions and absorption factor for materials in the ambient.
 - In emergency alarms the minimum sound pressure level in indoor environments, such as corridors, offices and entertainment rooms and in outdoor environments is 80dBA, with a minimum signal-to-noise ratio of 10 dB.
 - The minimum sound pressure level in emergency alarms in cabins and cabin bathrooms must be 75 dBA, with a signal-to-noise ratio of 10 dBA.
 - The minimum indoor sound pressure level for voice announcements must be 75 dBA, with a margin of at least 20 dB above the speech interference level.
 - The minimum sound pressure level for voice announcements in outdoor environments must be 80 dBA, with a margin of at least 15 dB above the speech interference level.
- 8.5 However, if the ambient noise levels reach exceedingly high levels — greater than 90 dB — then attempting to present a signal with sufficient level to overcome the ambient noise level will likely decrease the intelligibility of the message.
- 8.5.1. The total sound pressure level produced by combining the ambient sound pressure level with all audible notification appliances operating shall not exceed 110 dB(A) at the minimum hearing distance.
- 8.6 Within the set of documents that make up the Sounding Design it shall be provided in the arrangement plants the noise level gradients for all areas to be covered by the PAGA System.

8.6.1. Surrounding noise mapping modeling

CONTRACTOR shall calculate the noise map considering the FPSO Unit equipment noise only, without any loudspeaker of the PAGA System signal contribution, like an example illustrated on the figure below, which noise interval range used in heat map color must be 3dB minimum.

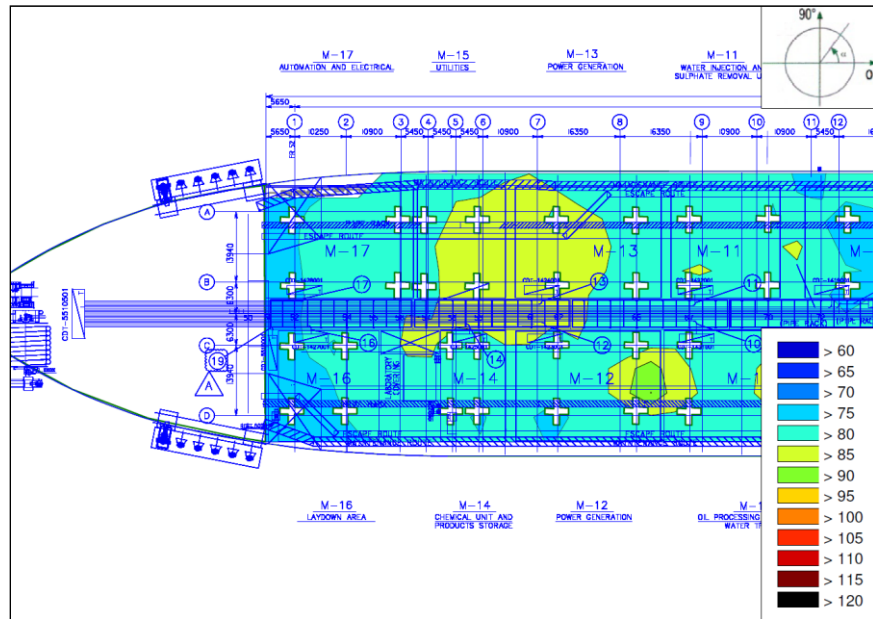

Figure 7: Example of FPSO Noise Mapping

8.6.2. PAGA loudspeakers noise mapping

CONTRACTOR shall calculate the signal map considering the FPSO Unit PAGA loudspeakers only, which noise interval range used in heat map color must be 3dB minimum.

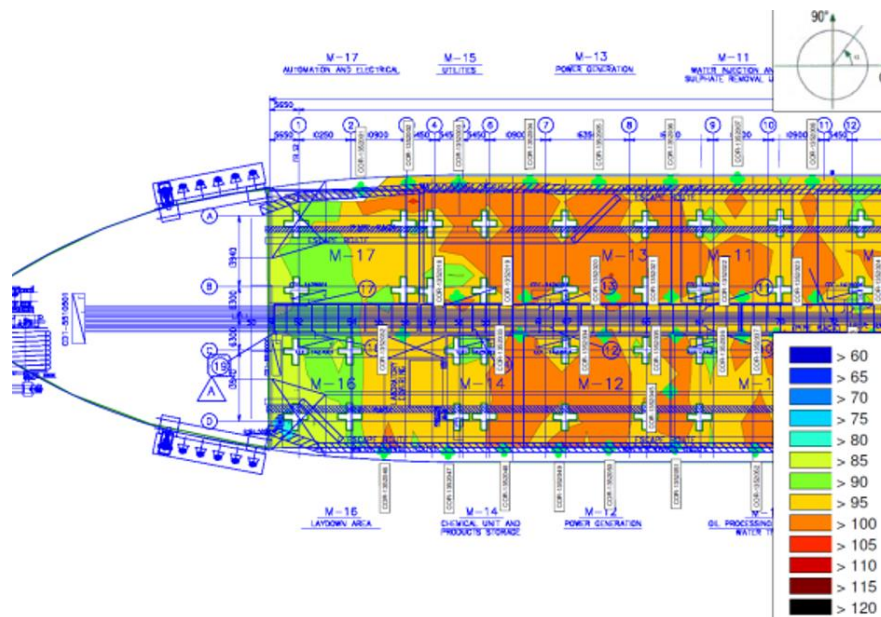

Figure 8: Example of PAGA loudspeakers Sound Mapping

8.6.3. Signal-to-noise ratio

The signal-to-noise ratio on the FPSO Unit Module (difference of surround pressure levels and PAGA loudspeakers) shall be given with PAGA loudspeakers, which noise interval range used in heat map color must be 3dB minimum.

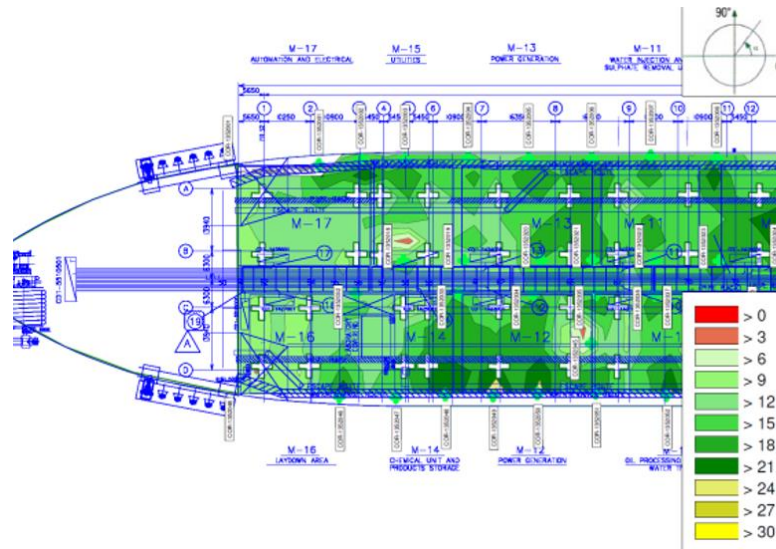

Figure 9: Example of Signal-to-Noise Mapping

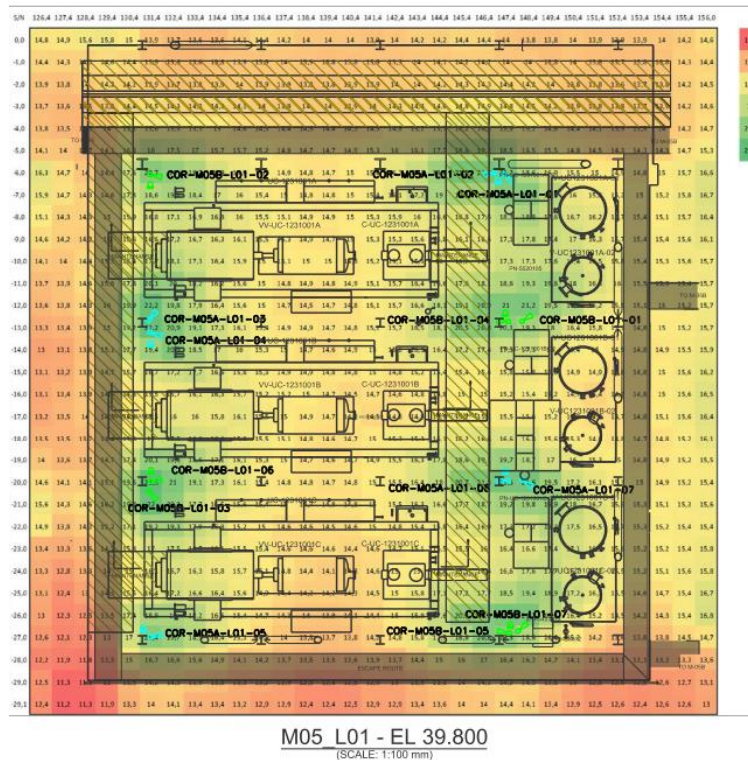

Figure 10: Example of Signal-to-Noise Mapping in a Module

8.6.4. Summary Table Results

TECHNICAL SPECIFICATION	Nº: I-ET-3010.00-5570-767-PPT-001	REV. C
AREA: -	SHEET: 37 of 38	
TITLE: HULL PUBLIC ADDRESS SYSTEM		INTERNAL
		OI/CS

- a. Addition to previous heat maps, technical information shall be presented on a summary Excel (or similar software) table of calculation including: required electrical powers of elements, defining the density of sound transducer distribution, parameters and technical criterion attributed.
- b. CONTRACTOR, after the Acceptance Performance Test (TAP), shall schedule with PETROBRAS and the Classification Society a new test onboard where shall be verified the audibility of alarms and speech messages for final approval of the PAGA System. If necessary, adjustments and increase of the equipment and accessories to obtain the final approval, it shall be done by CONTRACTOR without costs to PETROBRAS.

8.7 Electrical cable gauge

- 8.7.1. It shall be taken into account the voltage drop for long path cables so that the proper cable gauge can be calculated. One line diagram can be used as reference, but final dimensioning shall be calculated and presented for approval.
- 8.7.2. Final acceptance success is scope of CONTRACTOR.

9. COMMISSIONING

- 9.1 Before commissioning activities, CONTRACTOR shall measure and record impedance and power from each amplifier line towards each PAGA junction box and from each PAGA line inside each junction box towards field transducers.
- 9.2 Such measurement shall be done by calibrated digital power/impedance meter and decibel meter (like the ones from Manufacturer NTI-Audio) and reported by tables so that measured values can be compared to predicted values from calculation report.
- 9.3 All PAGA sub networks divided by areas and audio lines shall be ended so general audio measurements can be tested by calibrated audio meter devices.
- 9.4 PAGA-A and PAGA-B shall be commissioned individually.
- 9.5 For TAP-1, it will be possible to run test procedures for individual amplifiers lines that cover specific areas to be combined with PETROBRAS like engine room, accommodation, main deck and forecastle.
- 9.6 For Topsides modules it will be required that all PAGA transducers of each system A or B to be installed, per test procedures and per audio line, once on such areas the signal from neighborhood transducers reinforces the local measurement.
- 9.7 It shall be attended speech intelligibility in announcements as per IEC 60268-16 all over the Unit. Any specific instrument shall be used in order to confirm such intelligibility.

	TECHNICAL SPECIFICATION	Nº: I-ET-3010.00-5570-767-PPT-001	REV. C
	AREA:	SHEET: 38 of 38	
	TITLE:	HULL PUBLIC ADDRESS SYSTEM	
			INTERNAL
			OI/CS

9.8 As a matter of general acceptance, it shall be considered capacity and autonomy tests for battery banks and chargers done; alarm and announcement tests done; triggered alarm from CSS System done; intelligibility of alarms and announcements successes reached; PABX interface test and remote access from Corporative Network successfully done.